

Surgical Instruments Catalogue

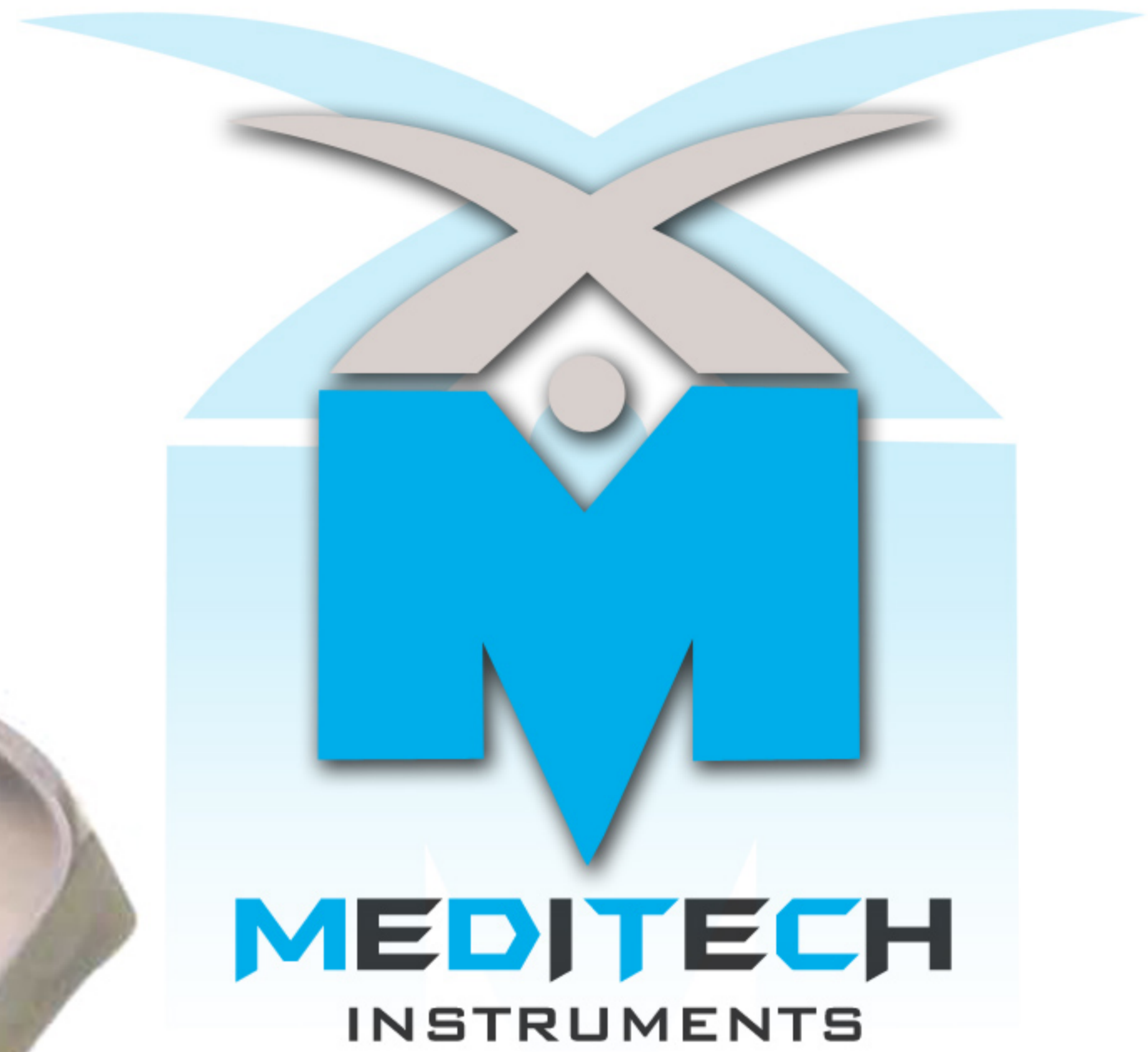



# MEDITECH

## INSTRUMENTS



### PROFILE

We present this catalogue with a hope that it would be an excellent guide to all our promoters and Medical professionals all over the world. We endeavor to present in this Catalogue a modern range of Dental instruments to the trade and medial professional in order to archieve the highest results. We are located in the centre of the City which is known the world over for this profession having at our disposal expert craftsmen whose skilled technique and traditional approach towards modern surgery makes all the possibilities to acclaim us quality instruments. We are grateful for the loyal support given to us by our promoters who have been selling our Stainless Steel Dental Instruments in their marker with pride and honor. We pledge to serve more in the years ahead to our quality minded promoters with much more higher standard and correct design of the instruments. We also welcome your enquiries for all kind of Dental Instruments not listed in this Catalogue Dental Instruments. It is our Ernest desire to maintain our present prices but due to the present universal economic condition which are beyond our control.

#### Note:

All prices Are Subject To Change Without Any Notice.

#### Labor Policy:-

We ensure there is "NO CHILD LABOR IN OUR COMPANY"

#### FOR FURTHER INFORMATION & FRESH UPDATES

visit our website: [www.meditech-inst.com](http://www.meditech-inst.com)

or Dial Our Numbers:

Tel: 0060105610036 Or +92-300-4415629



# TABLE OF CONTENTS



S. No.		Page No.
01	<i>Diagnostic / Preparation Instruments</i>	01
02	<i>Scalpel Holders, Amputation Knives &amp; Saws</i>	09
03	<i>General Operating Scissors / T.C. Scissors</i>	16
04	<i>Dressing &amp; Tissue Forceps / T.C. Forceps</i>	33
05	<i>Haemostatic Forceps</i>	40
06	<i>Needle Holders / T.C. Needle Holders</i>	56
07	<i>Retractors</i>	73
08	<i>Cardiovascular &amp; Thoracic Instruments</i>	88
09	<i>Orthopaedics</i>	99
10	<i>Neurosurgery Instruments</i>	124
11	<i>Ophthalmology Instruments</i>	130
12	<i>Ear, Nose, Throat Surgery (ENT Surgery)</i>	133
13	<i>Intestinal, Rectal Instruments &amp; Urology</i>	149
14	<i>Gynecology / Obstetrics Instruments</i>	159
15	<i>Hollow Wares</i>	175



# DIAGNOSTIC SETS & CATHETER INTRODUCING FORCEPS

Diagnostik-bestecke, Kathetereinführzangen  
Diagnostic Setts, Pinzas para catéteres

Estuches de diagnostico, Pincas pour introduire les sondes  
Combinazioni per diagnostica, Pinze per introdurre le sonde



**DIAGNOSTIC SET  
(ENT COMPLETE)  
01-100**

Consisting of Battery Handle (without Battery)  
3 Ear Specula, 1 Nasel Specula,  
2 Laryngeal Mirrors with Holder  
1 Tongue Depressor Holder, 1 Bulb

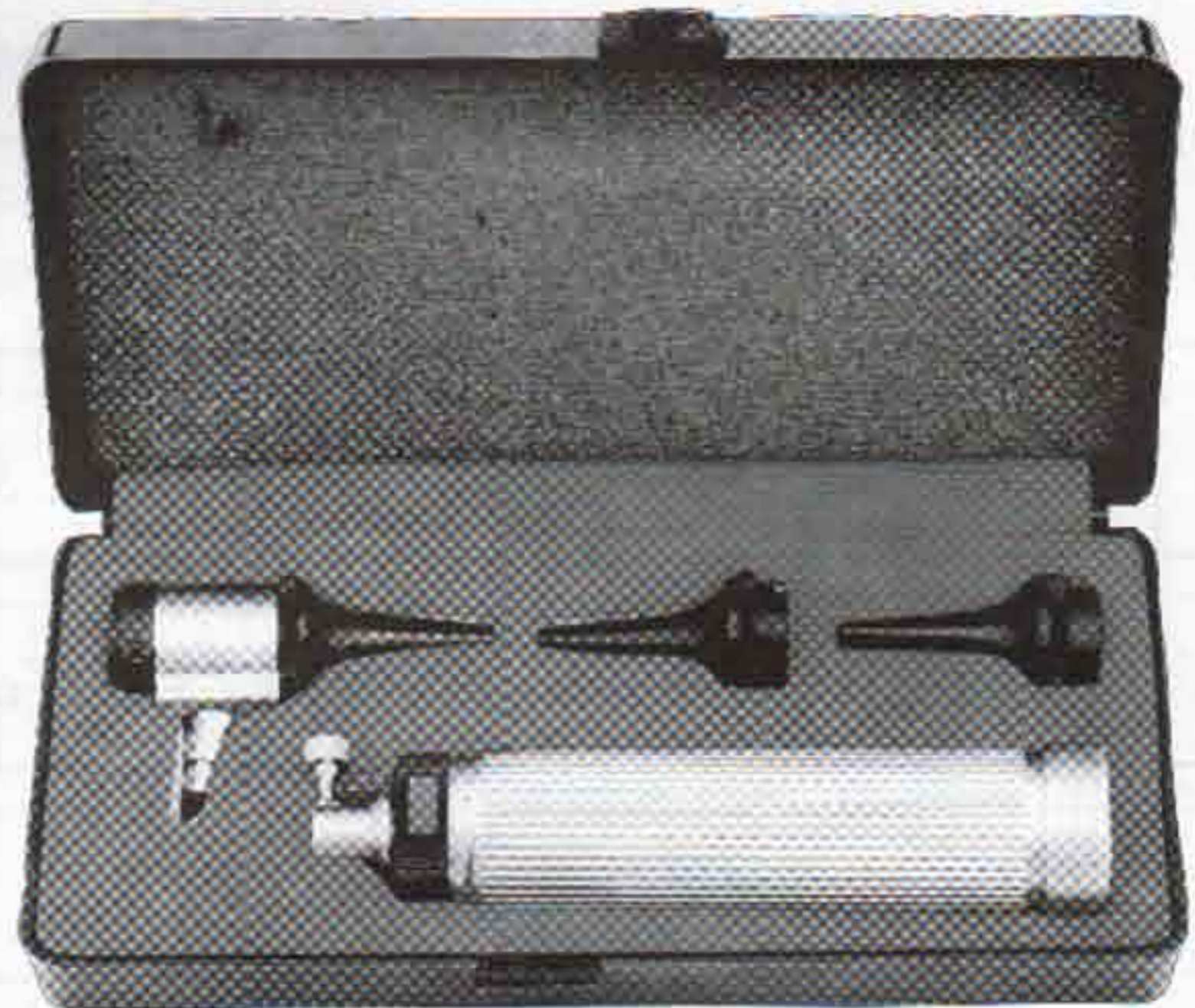

**OTOSCOPE SET  
01-110**

Consisting of Battery Handle  
(without Battery)  
3 Ear Specula, 1 Nasel Specula,

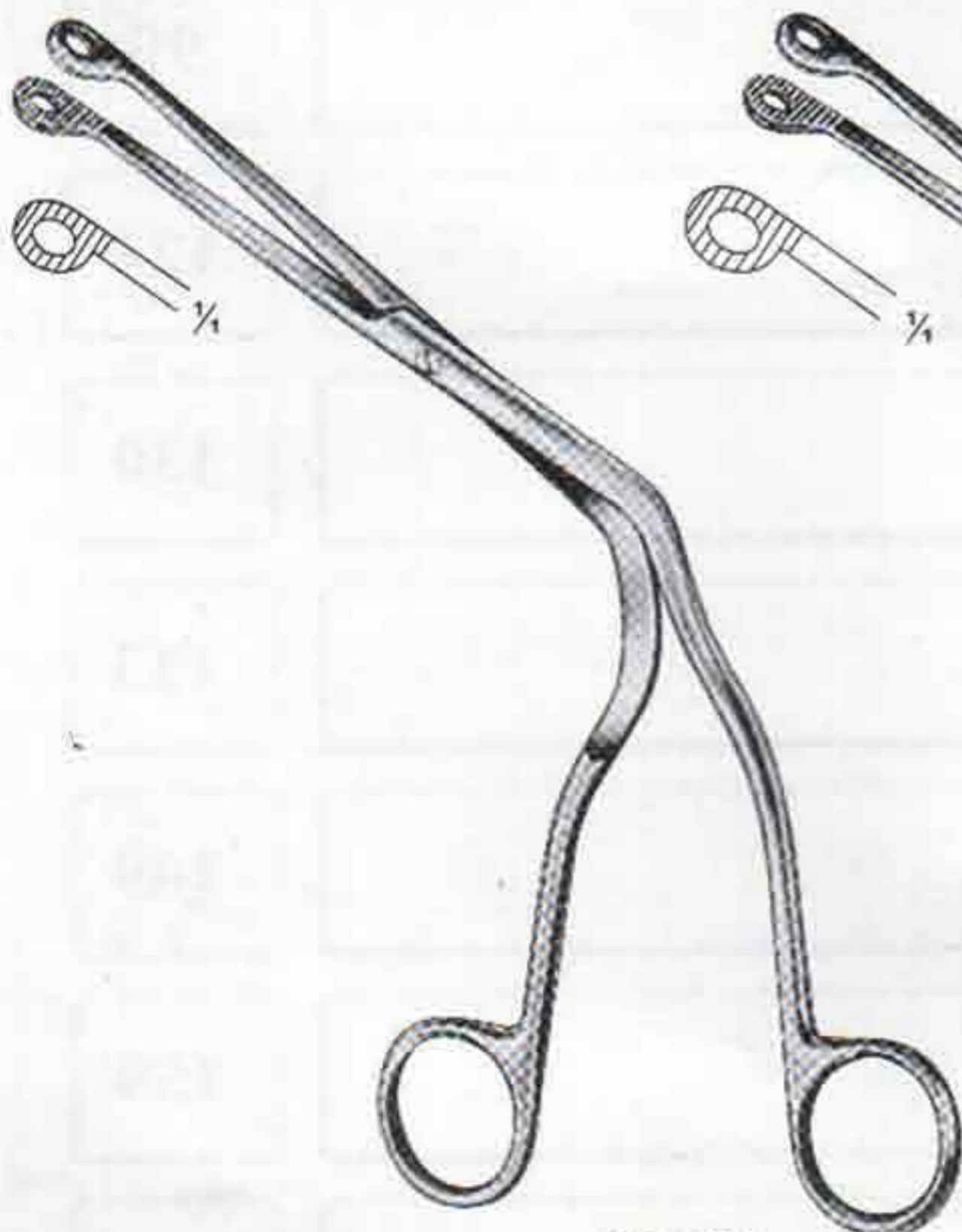

**MAGILL  
01-130  
17 cm, 6 3/4"**

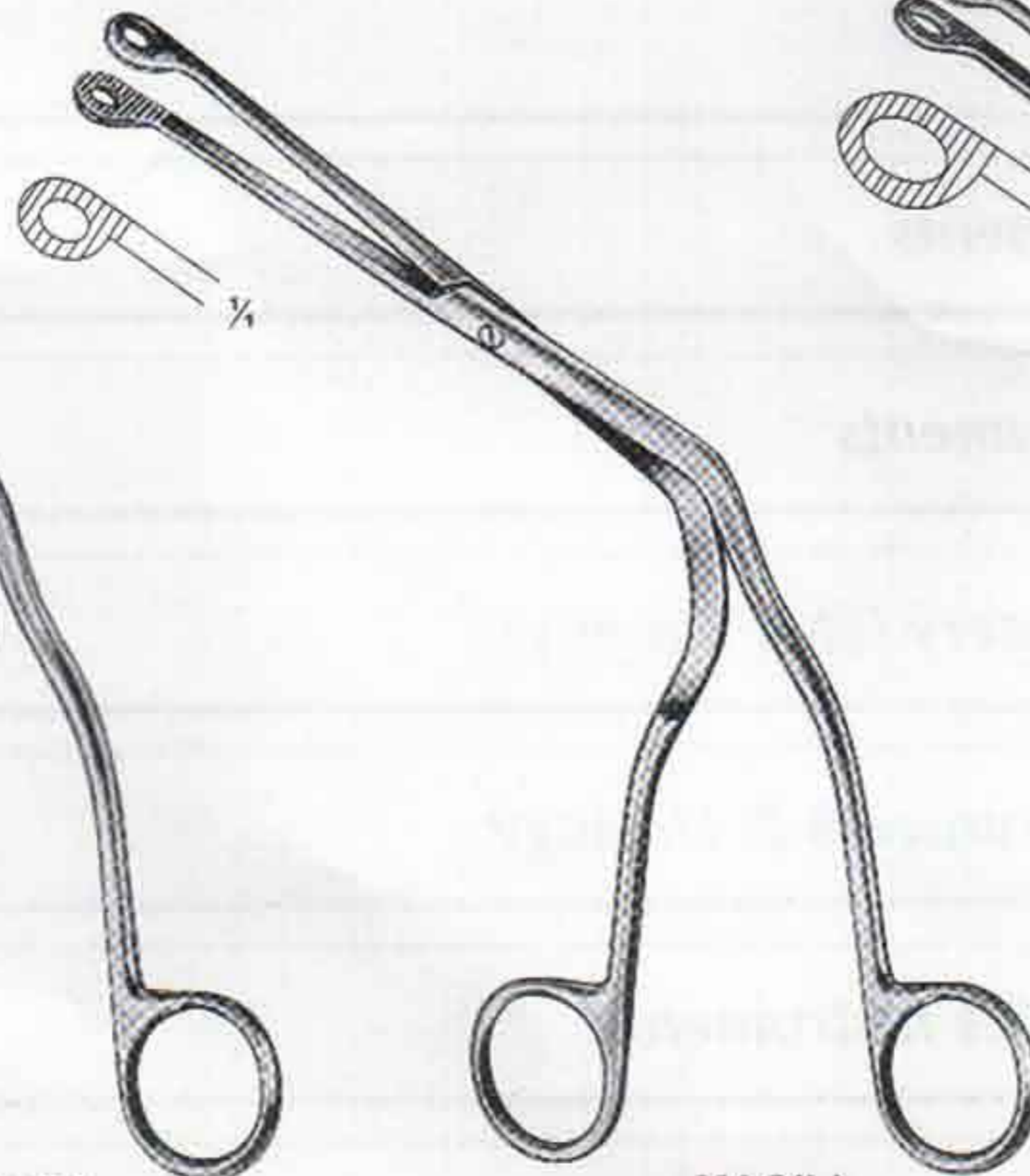

**MAGILL  
01-140  
20 cm, 8"**



**MAGILL  
01-150  
25 cm, 10"**



# LARYNGOSCOPE & ACCESSORIES

Laryngoskope und Zubehör  
Laringoscopios y Accessories

Laryngoscopes et accessories  
Laringoscopi ed accessori



## GUEDEL-NEGUS

01-160

Battery handle only  
with for Laryngoscope  
blades No. 1 to 4  
complete, in case.



## MCINTOSH

01-170

Fiber Optic Laryngoscope set  
with 4 blades  
(fig. 01 to 04) in wooden/ rexin box.



Fig. 01  
01-162



Fig. 02  
01-164



Fig. 03  
01-166



Fig. 04  
01-168



## BATTERY HANDLE

01-180

without battery  
Use with battery - Size C  
(01-162 - 01-168  
01-172 - 01-178)



Fig. 01  
01-172

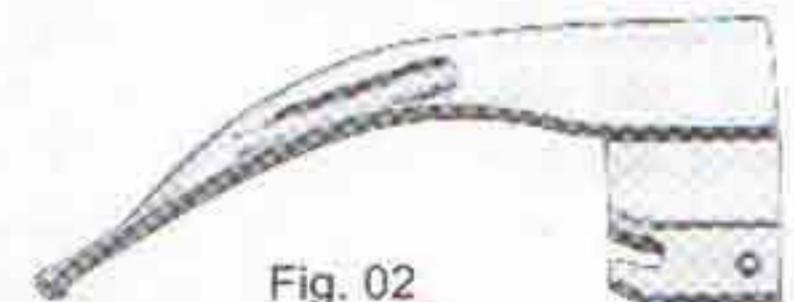

Fig. 02  
01-174



Fig. 03  
01-176

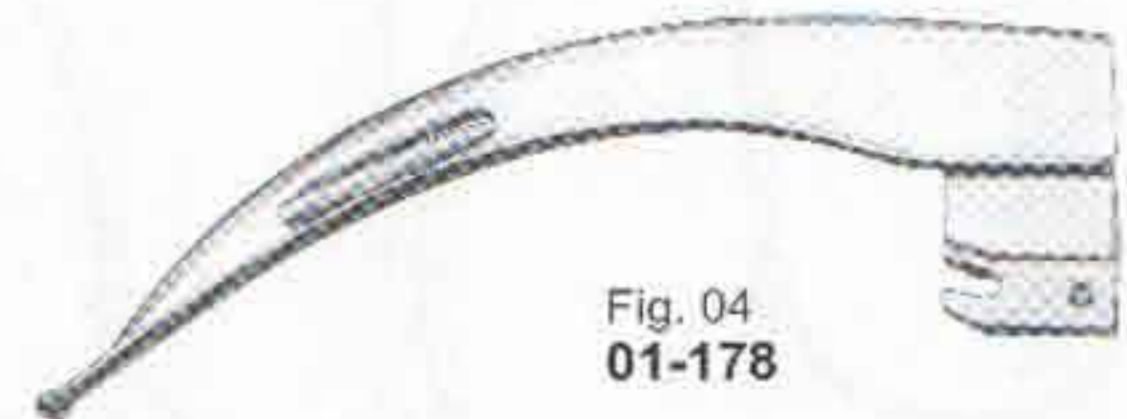

Fig. 04  
01-178



# STETHOSCOPES

Stethoskope  
Estetoscopios

Stéthoscopes  
Stetoscopi

## Blood Lancets

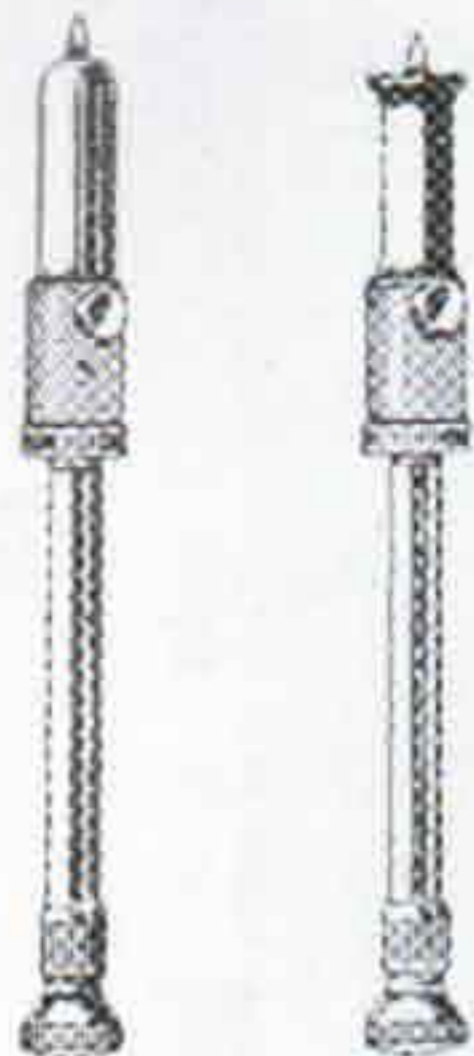

FRANCKE  
01-190

FRANCKE  
01-200

## CHEST PIECES



BOWLES  
01-210



FORD  
01-220



LIGHT WEIGHT  
01-230



SPRAGUE-BOWLES  
01-240



BOWLES  
01-250



FORD  
01-260



BELL-END  
01-270



SPARE RUBBER  
01-280



DIAPHARM  
01-290



SCHIMMELBUSCH  
01-300 ADULT  
01-302 CHILD

## INHALERS



YANKAUER  
01-310 ADULT  
01-312 CHILD

## AIRWAYS



CONNELL  
01-320 ADULT  
01-322 CHILD

## FRAMES



HEAD FRAME  
(FOR LIHTWEIGHT)  
01-330

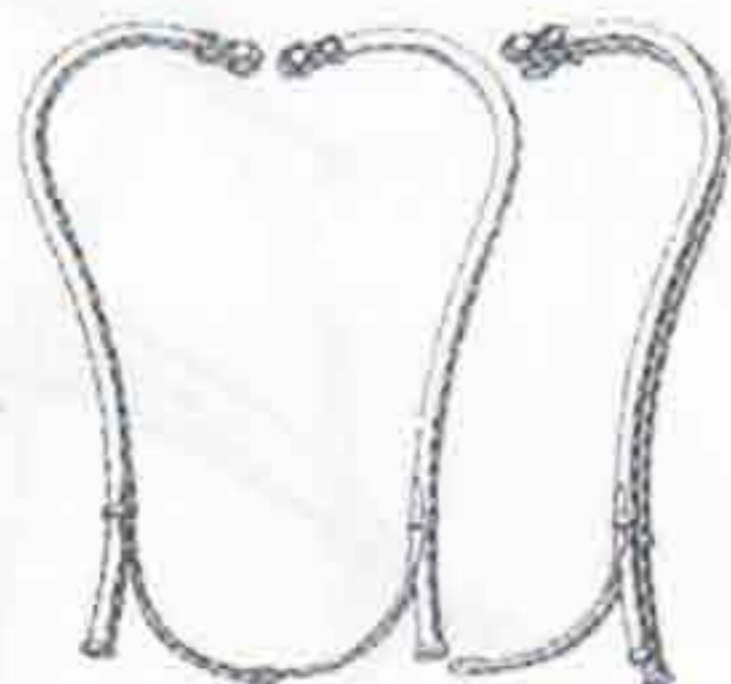

HEAD FRAME  
(FOR BINURAL)  
01-332



BOWLES  
01-334



FORD  
01-336



FORD-BOWLES  
01-338



LIGHTWEIGHT  
01-340



PINARD  
01-350 ALUMINIUM  
01-351 WOODEN



# PERCUSSION HAMMERS

Perkussionshämmer  
Martillos de percusion

Marteaux-percuteurs  
Martelli percussori



**NEURO-DUOFLEX**  
01-360  
22 cm, 8 3/4"



**DEJERINE**  
01-370  
20 cm, 8"

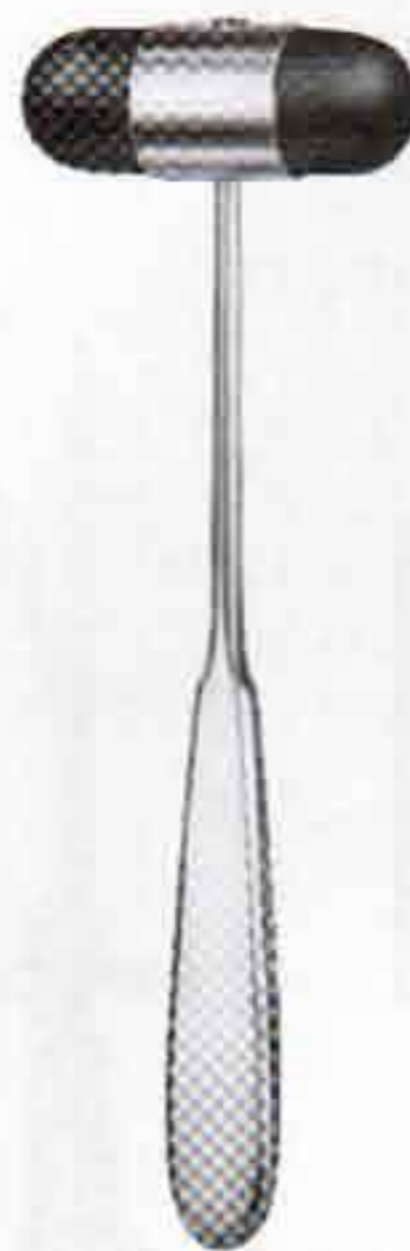

**DEJERINE**  
01-380  
20 cm, 8"



**TROEMNER**  
01-390 145 g  
01-392 175 g  
01-394 235 g  
24.5 cm, 9 3/4"  
spare rubber

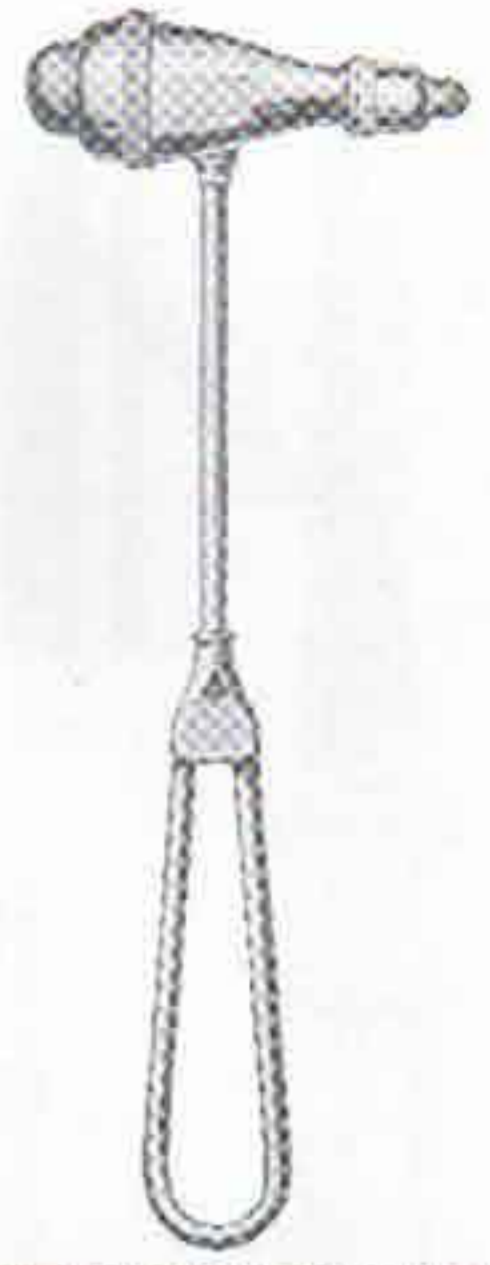

**TROEMNER-SIMPLEX**  
01-400  
21 cm, 8 1/4"



**BUCK**  
01-410  
18.5 cm, 7 1/4"

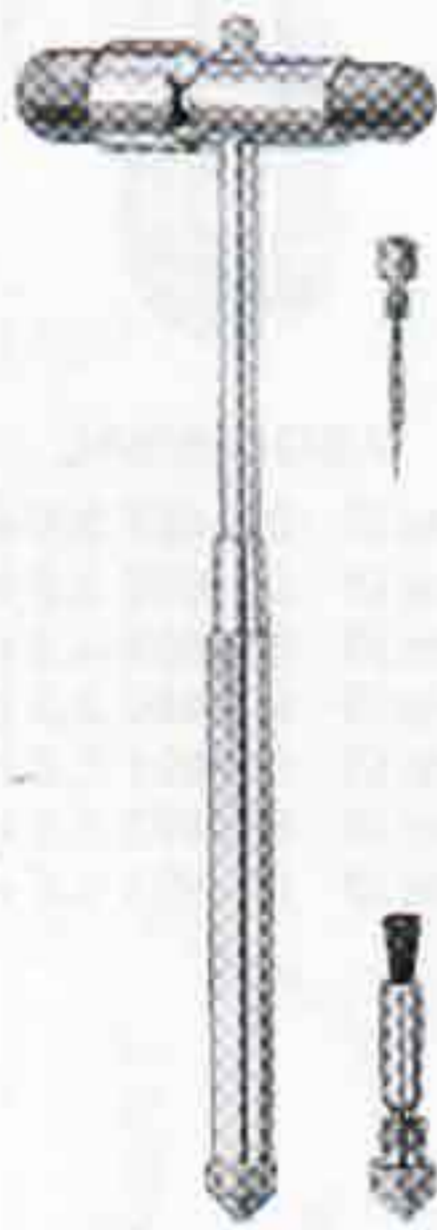

**BUCK HAMMER**  
01-412  
18 cm, 7"



**TAYLOR**  
01-420 18 cm, 7"  
01-422 20 cm, 8"



**TAYLOR**  
01-424  
18 cm, 7"



**BABINSKY**  
01-430  
22 cm, 8 3/4"



**BABINSKY**  
01-432  
22 cm, 8 3/4"



**RABINER**  
01-434  
25.5 cm, 10"  
with needle & brush

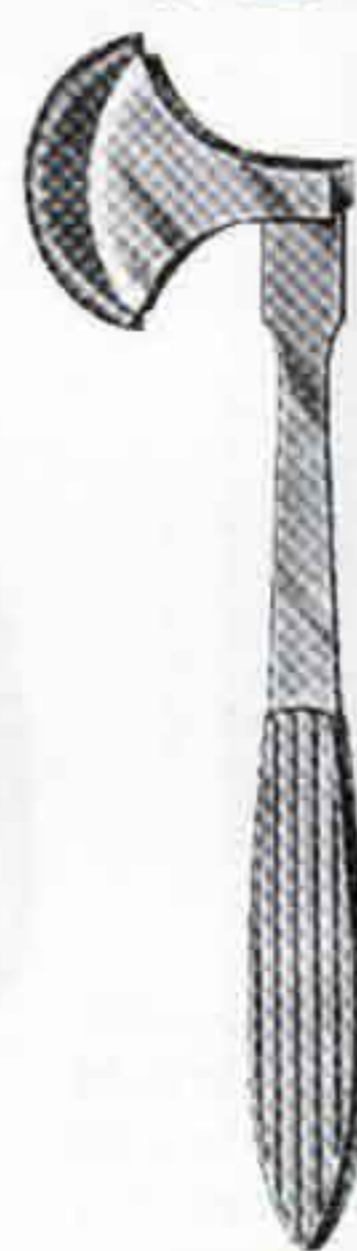

**BERLINER**  
01-440  
20.0 cm, 8"

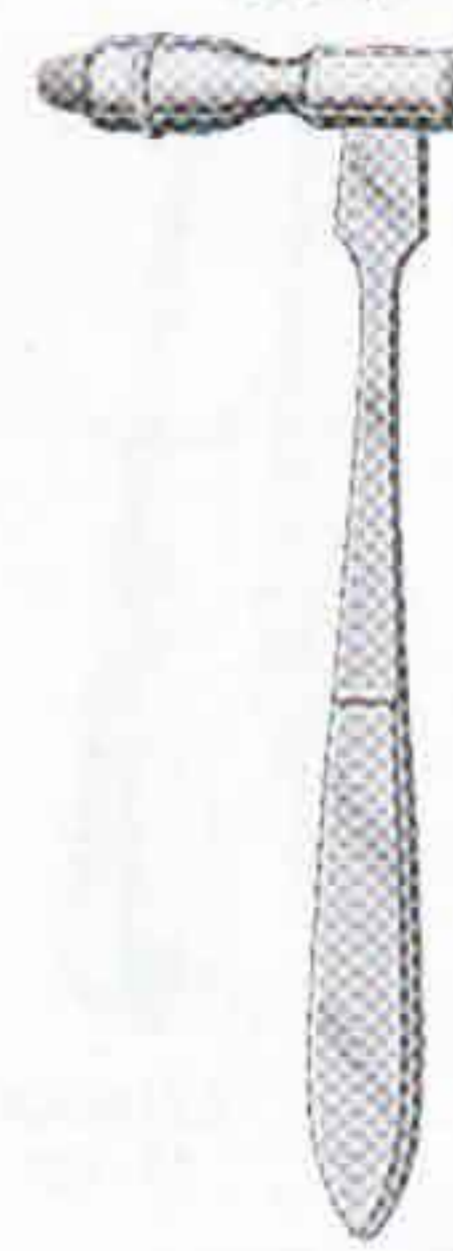

**TRAUBE**  
01-450  
16 cm, 6 1/4"



**WARTENBERG**  
01-460  
19 cm, 7 1/2"



# TROCARS

Trokare  
Trócares

Trocarts  
Trequarti

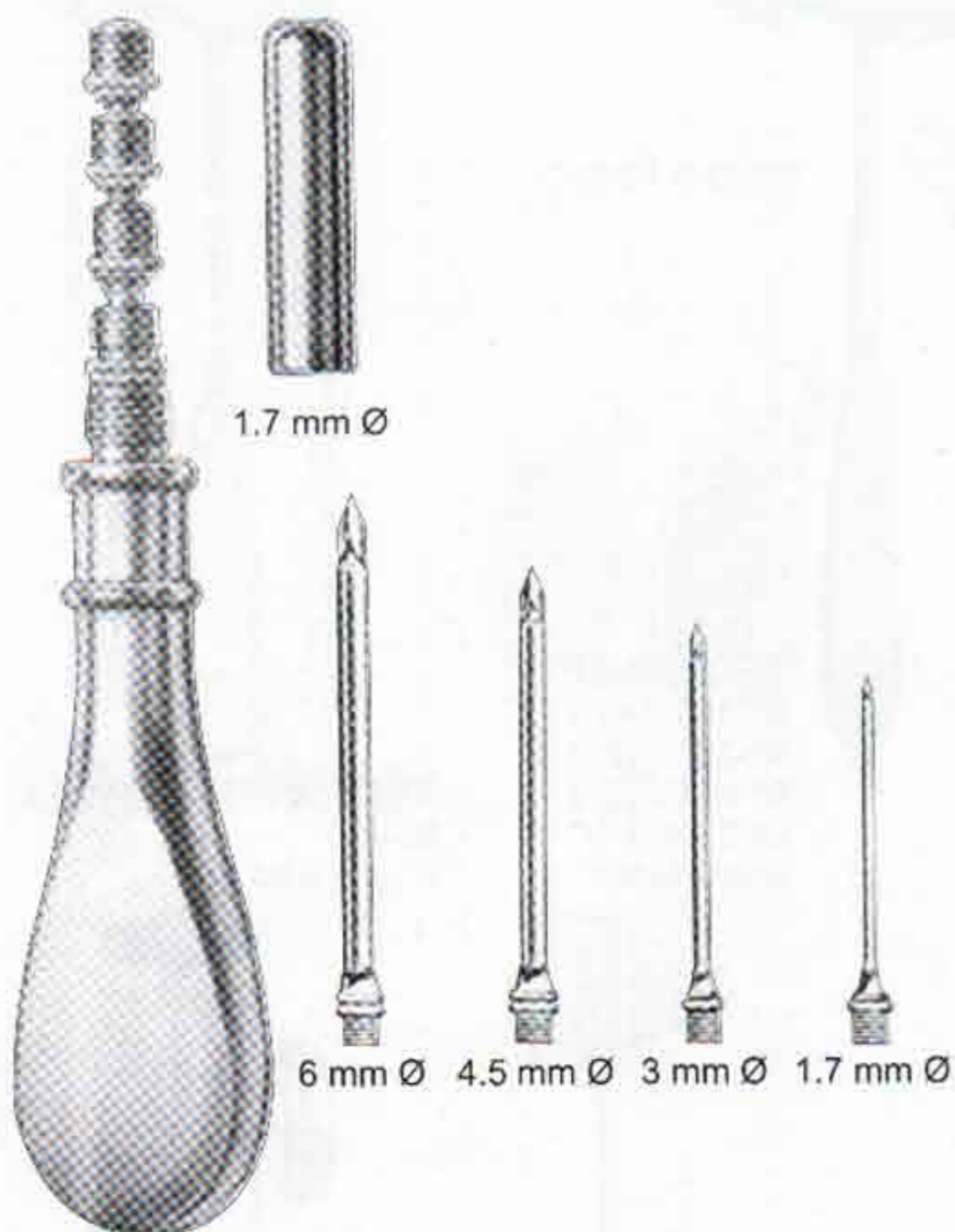

**UNIVERSAL**  
01-470 Set of 4



**UNIVERSAL**  
01-475 Set of 3

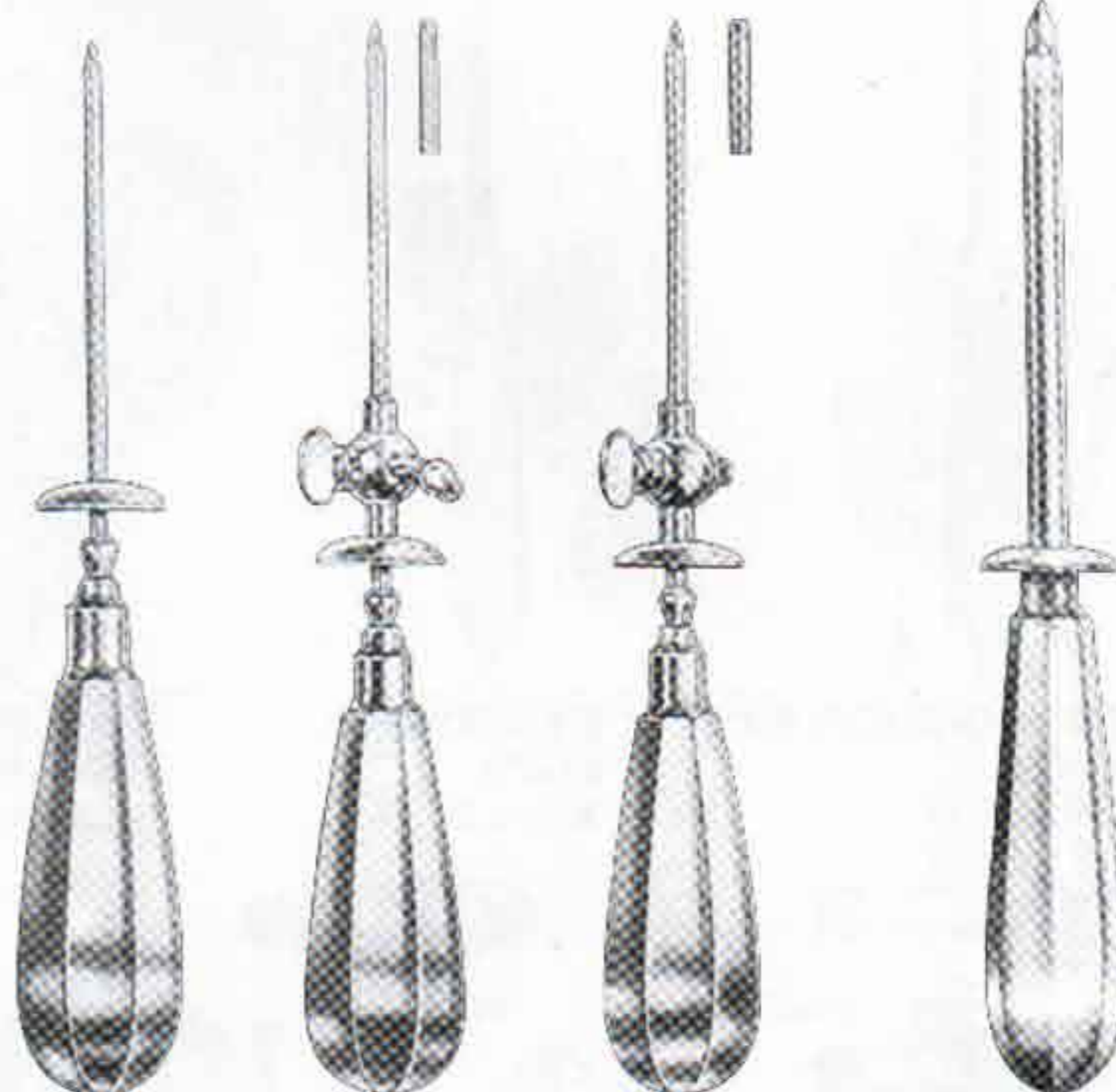

**ABDOMINAL**

01-480	3.0 mm Ø	01-487	3.0 mm Ø	01-494
01-481	3.5 mm Ø	01-488	3.5 mm Ø	01-495
01-482	4.0 mm Ø	01-489	4.0 mm Ø	01-496
01-483	3.5 mm Ø	01-490	3.5 mm Ø	01-497
01-484	5.0 mm Ø	01-491	5.0 mm Ø	01-498
01-485	5.5 mm Ø	01-492	5.5 mm Ø	01-499
01-486	6.0 mm Ø	01-493	6.0 mm Ø	01-500

**NELSON**  
01-505 25 Fg.  
01-506 25 Fg.  
01-507 25 Fg.  
01-508 25 Fg.

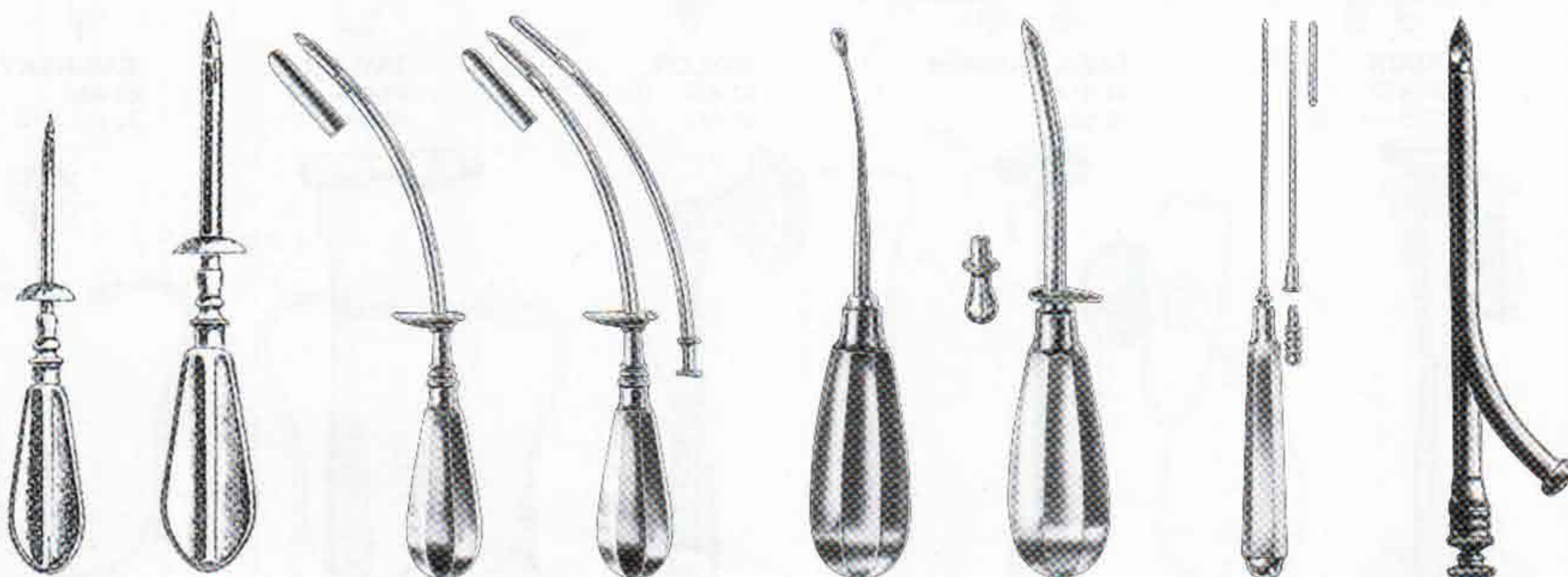

**HYDROCELE**  
01-510 8Fg.  
01-511 9Fg.  
01-512 10Fg.

**ACITES**  
01-520 16Fg.  
01-521 21Fg.

**FLEURANT**  
01-530

**FLEURANT**  
01-532

**KRAUSE**  
01-540 5.5mm Ø

**LICHTWITZ**  
01-550 1.75mm Ø

**OCHSNER**  
01-560 10Fg.  
01-561 12Fg.  
01-562 14Fg.  
01-563 16Fg.  
01-564 18Fg.  
01-565 20Fg.



# SUCTION TUBES

Sauger, Saugrohre  
Tubos de aspiración

Tubos d aspiracion  
Tubi d aspirazion

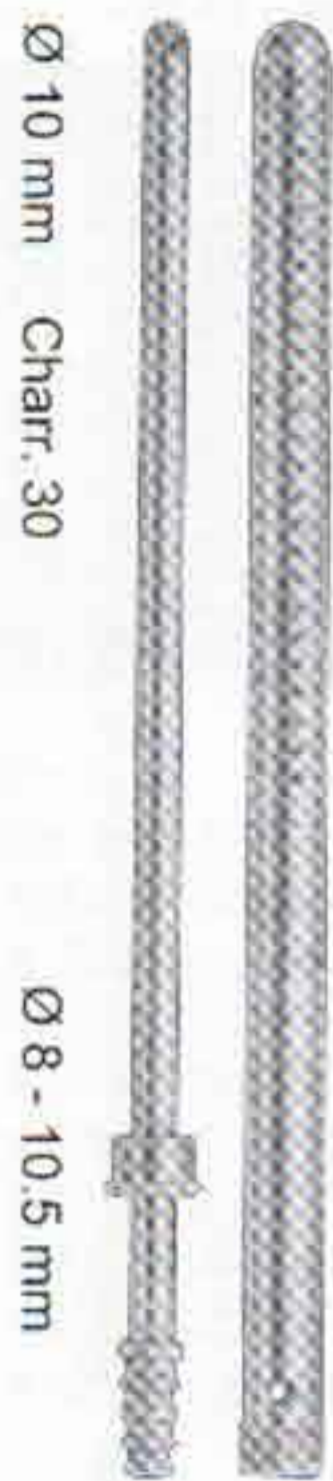

**POOL**  
01-570 30 Fg.



**POOL**  
01-575 30 Fg.



**COOLEY**  
01-580  
33.0 cm, 13"



**COOLEY**  
01-585  
35 cm, 13 3/4"

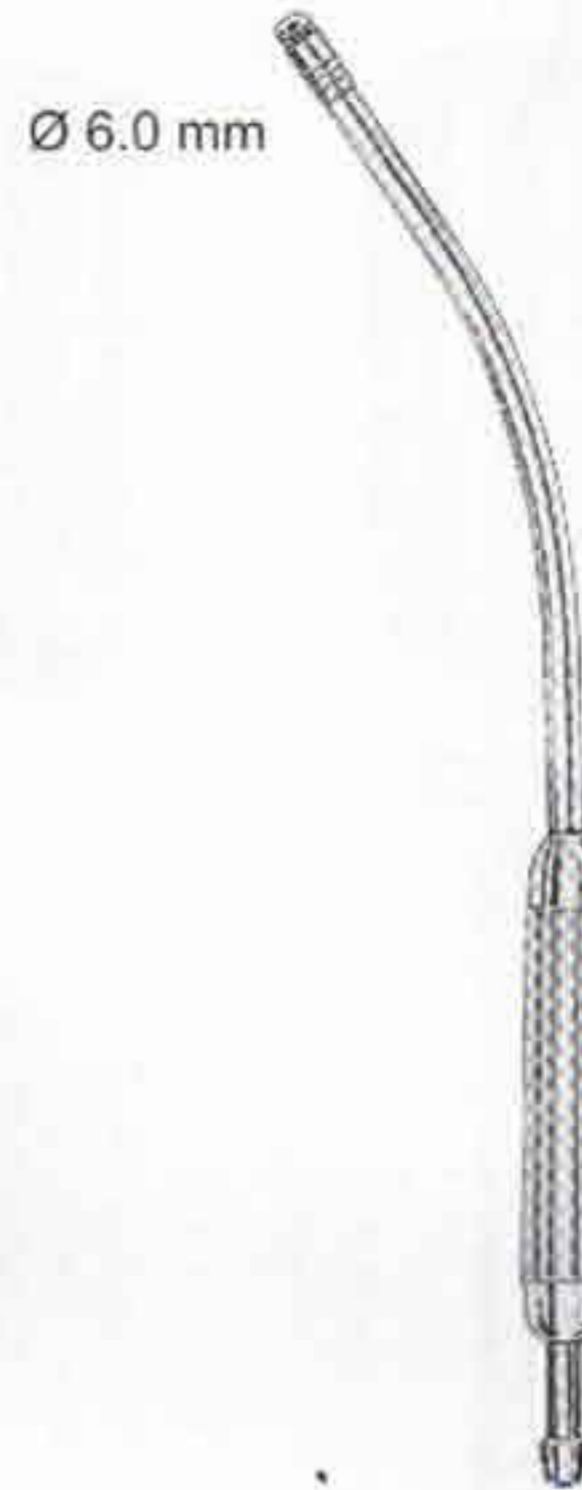

**COOLEY**  
01-590  
30.0 cm, 12"

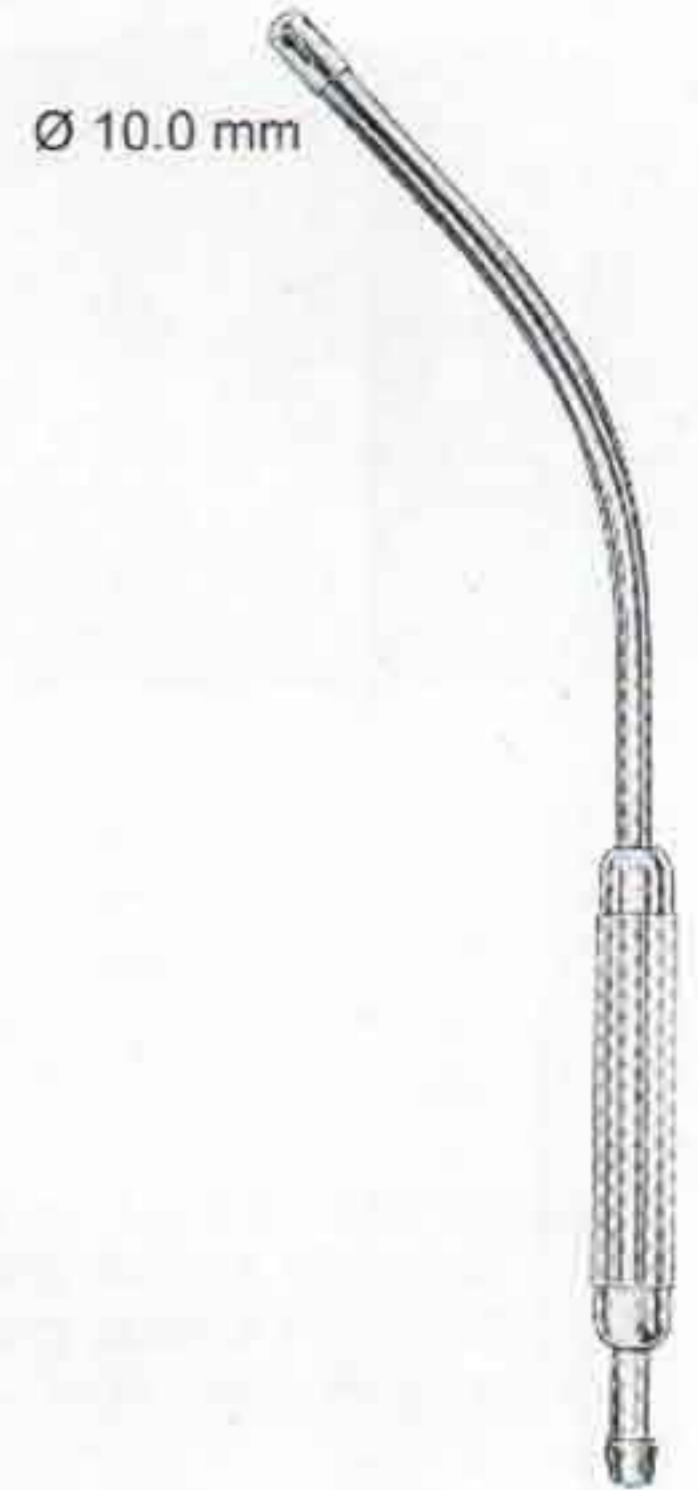

**COOLEY**  
01-595  
31.0 cm, 12 1/4"



**MILLIN'S SUCTION TUBE**  
01-600  
chromium-plated,  
with sliding "on & off"  
action.

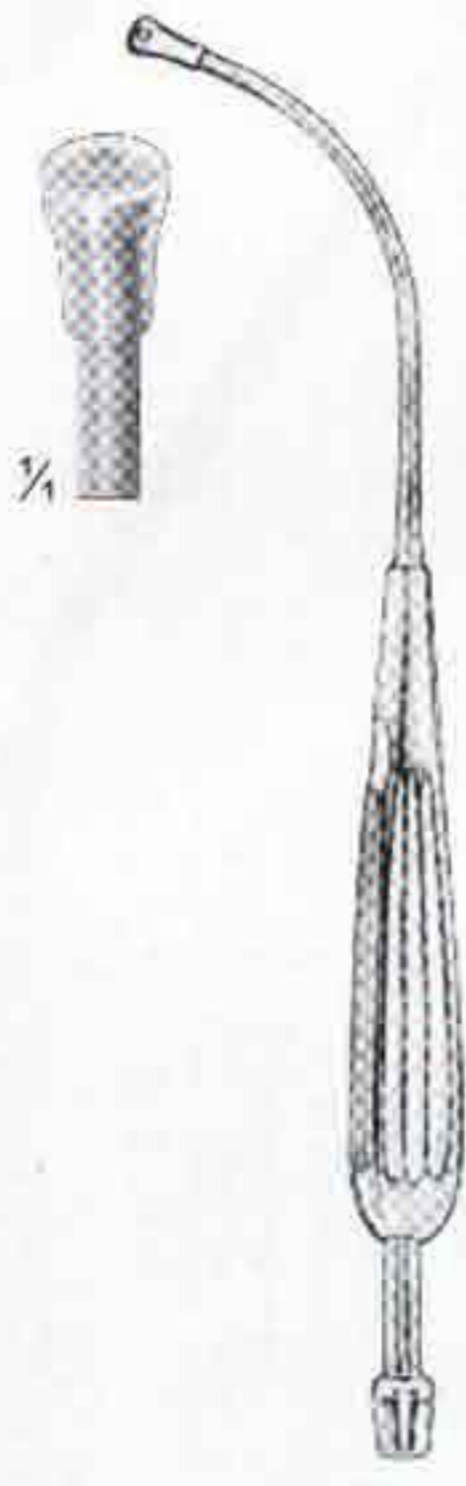

**YANKAUER**  
01-605



**YANKAUER**  
01-610  
28.5 cm, 11"  
with especially large  
central bore, 4.8 mm  
clam



**YANKAUER**  
01-615  
28.5 cm, 11"  
with central bore,  
2.0 mm Diam.



**DE-BAKEY**  
01-620  
28.5 cm, 11"  
with central bore,  
3.0 mm Diam. With  
lateral slots



# SUCTION TUBES

Sauger, Saugrohre  
Tubos de aspiración

Tubos d aspiracion  
Tubi d aspirazion

Ø 1.5 mm

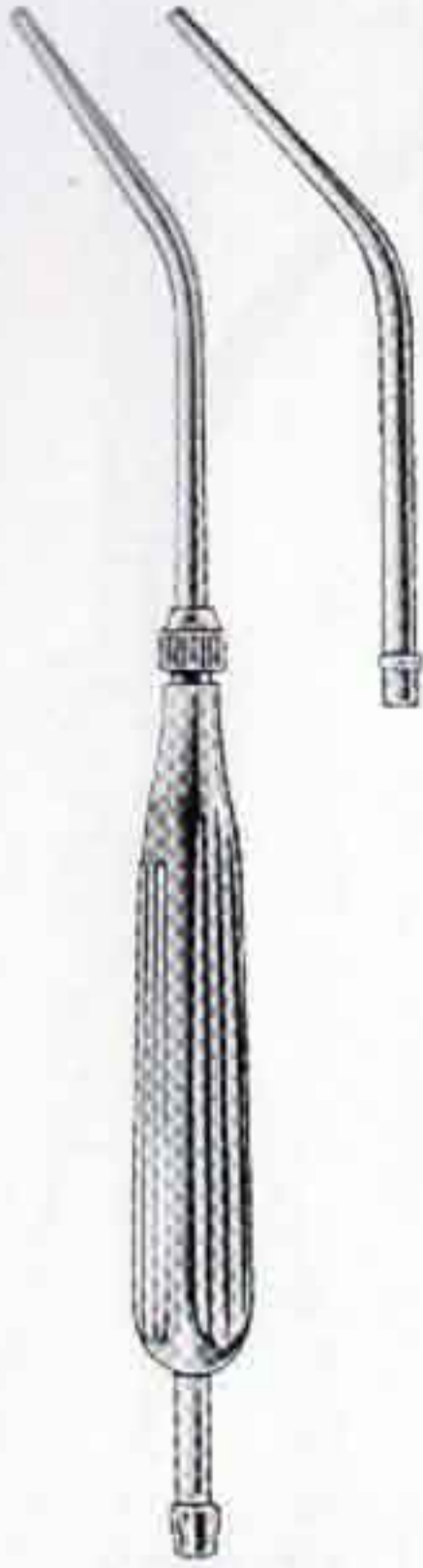

**COUPLAND**  
01-630

Ø 2.0 mm



**BYRD**  
01-640 1.5 mm  
01-645 2.5 mm  
01-650 3.5 mm

Ø 5 mm



**DE-BAKEY**  
01-660  
16 cm, 5"  
with finger cut-off  
and stylet

Ø 4 mm



**01-665**  
19 cm, 7 1/4"  
cut-off

Ø 5 mm



**DE-BAKEY**  
01-670  
27 cm, 10 3/4"  
with finger cut-off  
and stylet

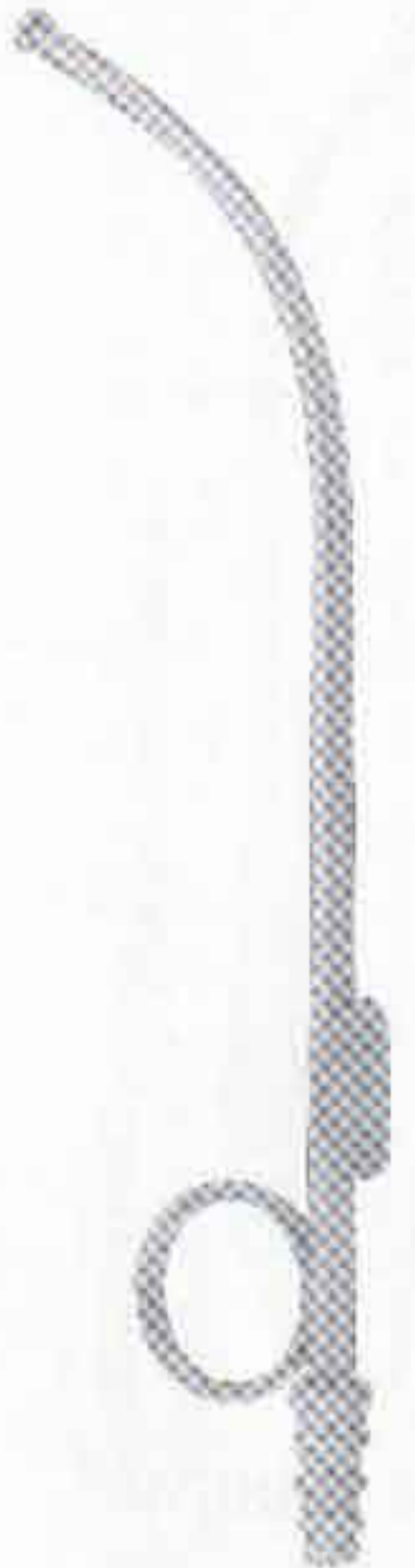

01-680 Ø 4.5 mm  
01-690 Ø 5.5 mm  
17.5 cm, 7"  
Nasal suction tubes



**LOPEZ-REINKE**  
01-700  
23.5 cm, 9"  
tonsil dissector with  
suction device

Ø 6-9 mm

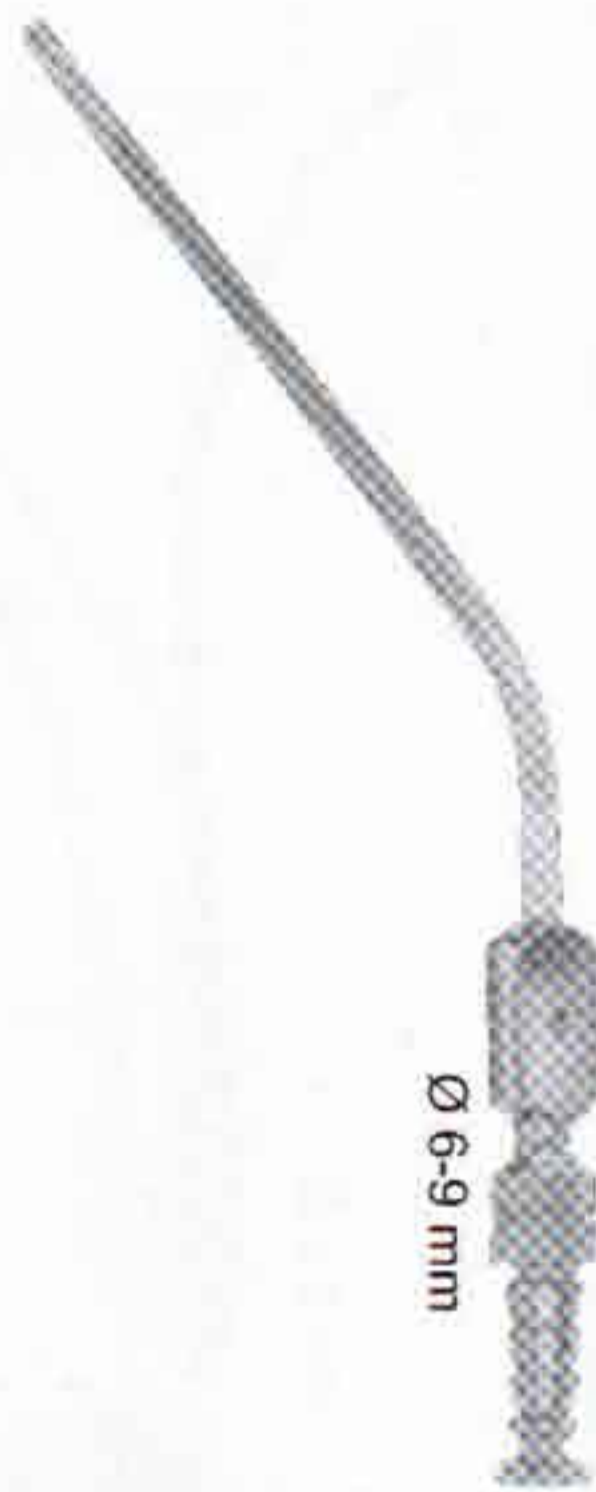

**FERGUSSON**  
01-710 Ø 4.0 mm  
18 cm, 7"  
insulated, with finger  
cut-off and stylet, thumb  
piece 90° to curved, with  
Luer hub

Ø 6-9 mm



**FRAZIER**  
01-720 Ø 3.0 mm  
01-725 Ø 5.0 mm  
18 cm, 7"  
insulated, with finger  
cut-off and stylet, thumb  
piece 90° to curved, with  
Luer hub

Ø 6-9 mm

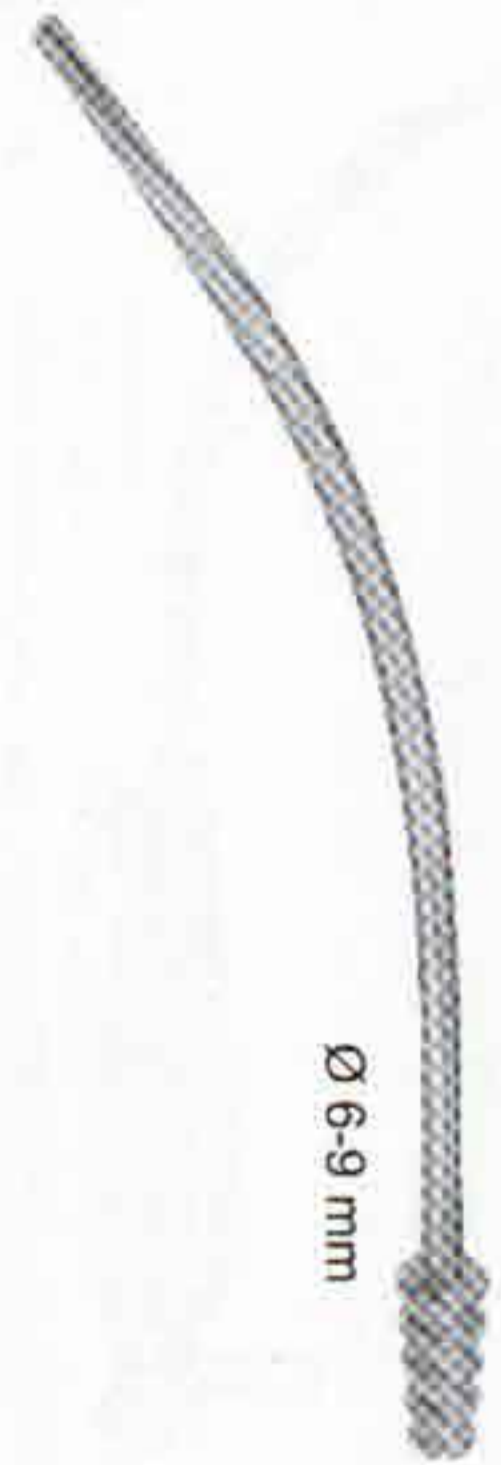

**01-730**  
18 cm, 7"  
Ø 5.0 mm diam., Tip  
6.5 mm wide nasal  
section tube, with  
luer hub



# DISSECTING KITS

Diagnostik-bestecke  
Diagnostic Setts

Estuches de diagnostico  
Combinazioni per diagnostica

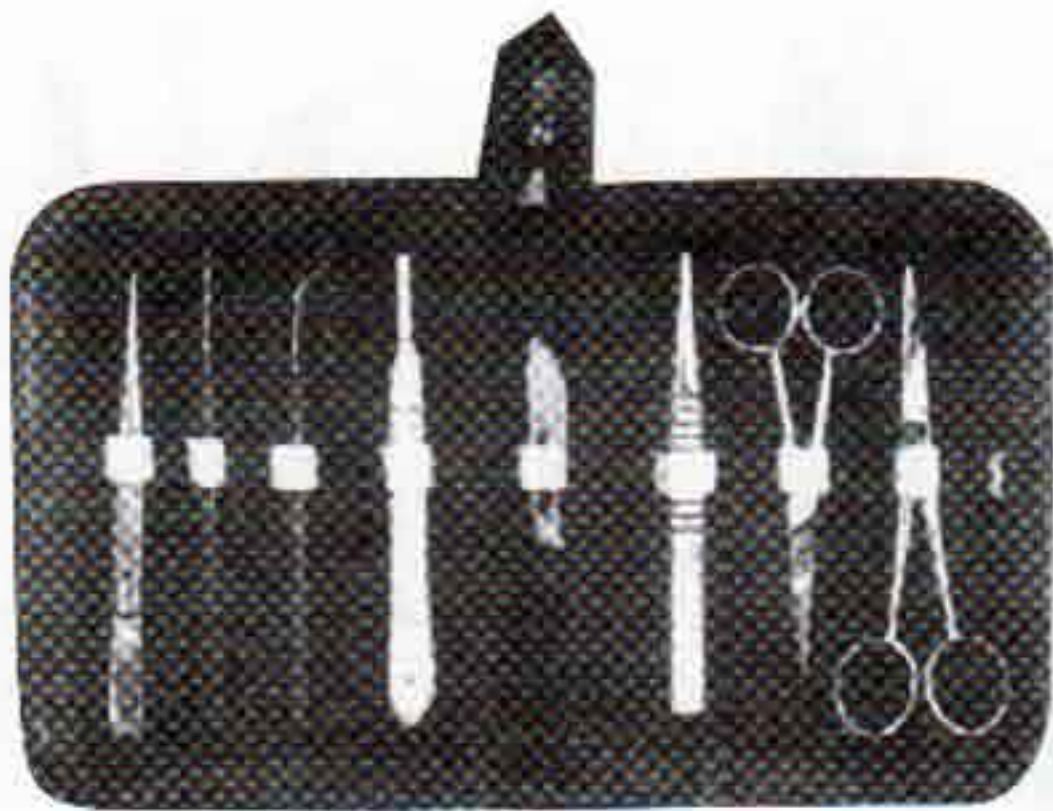

## 01-740

Set of 9 Pcs.

- Dissecting Forceps 11.5cm Sharp Point.
- Teasing needle Sharp STR.
- Teasing Needle Sharp Angular.
- B.P Handle No.4.
- Blade No. 22.
- Thumb Forcep T.O.E 13cm.
- Dissecting Scissor STR 11.5cm.
- Dissecting Scissor STR 13cm.
- Zipper Case Inside Red Velvet.

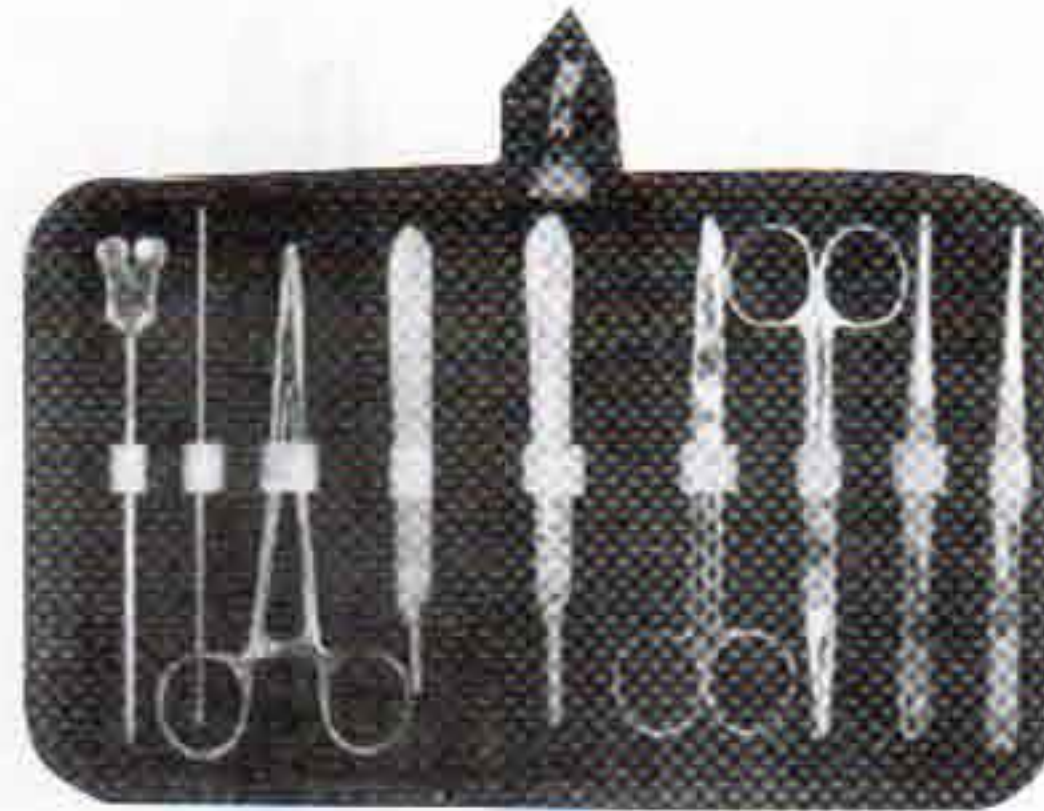

## 01-750

Set of 10 Pcs.

- Grooved Director with Tongue Tie 14cm.
- Probe Double 14cm.
- Mayo Hegar Needle Holder 14cm.
- B.P Handle No.3
- B.P Handle No.4
- Dressing Scissor 14cm S/B STR.
- Dressing Scissor 14cm S/B CVD.
- Dressing Forcep 1x2 teeth 14cm.
- Dressing Forcep Serrated 14cm.
- Zipper Case Inside Red Velvet.

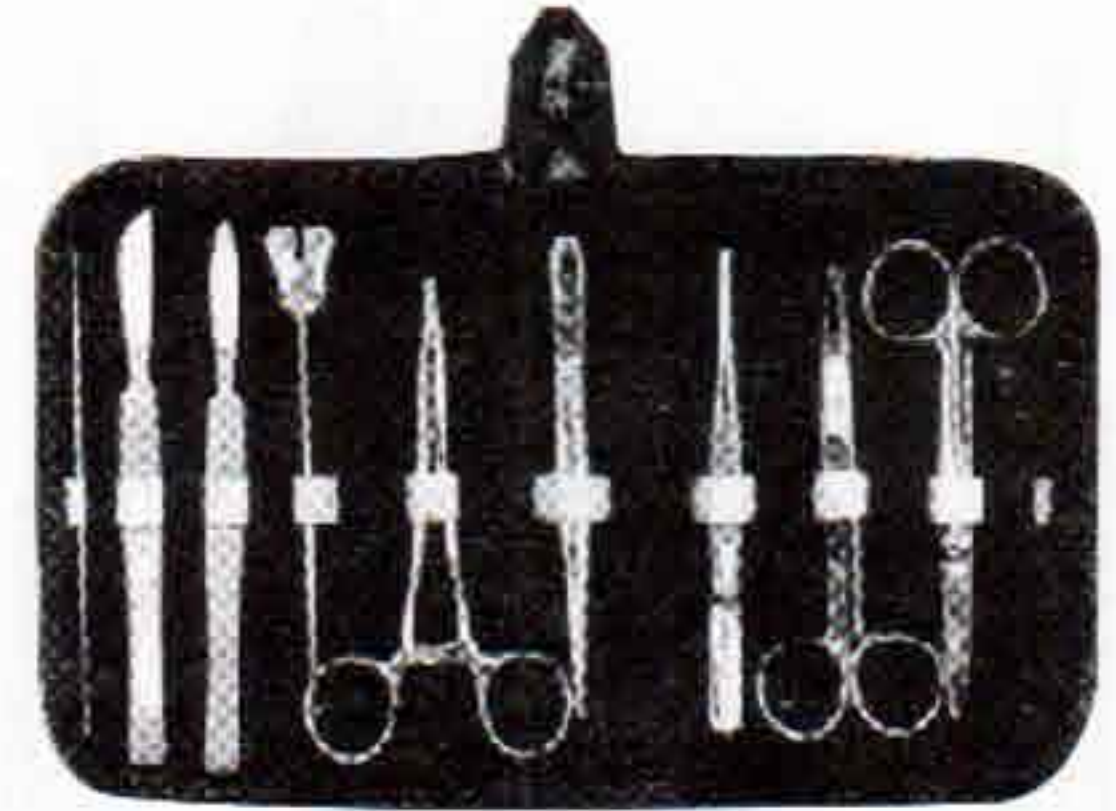

## 01-760

Set of 10 Pcs.

- Probe Double 13cm.
- 2PCS. Scalpel S.S.
- Grooved Director With Tongue Tie 14cm
- Mayo Hegar Needle Holder 14cm.
- Dissecting Forceps 14cm 1x2 Teeth.
- Dressing Forceps 14cm Serrated.
- Dressing Scissor 14cm S/B STR.
- Dressing Scissor 14cm S/B CVD.
- Zipper Case Inside Red Velvet.



## 01-770

Set of 10 Pcs.

- Blow Pipe.
- 3PCS Scalpel.
- Dissecting Forceps 14cm.
- Grooved Director With Tongue Tie 14cm
- Triple Chain Hook.
- Dressing Scissor Probe Pointed 14cm.
- Probe Double 14 cm.
- Zipper Case Inside Red Velvet.



## DISSECTING SET

01-780 Containing 9 Instruments

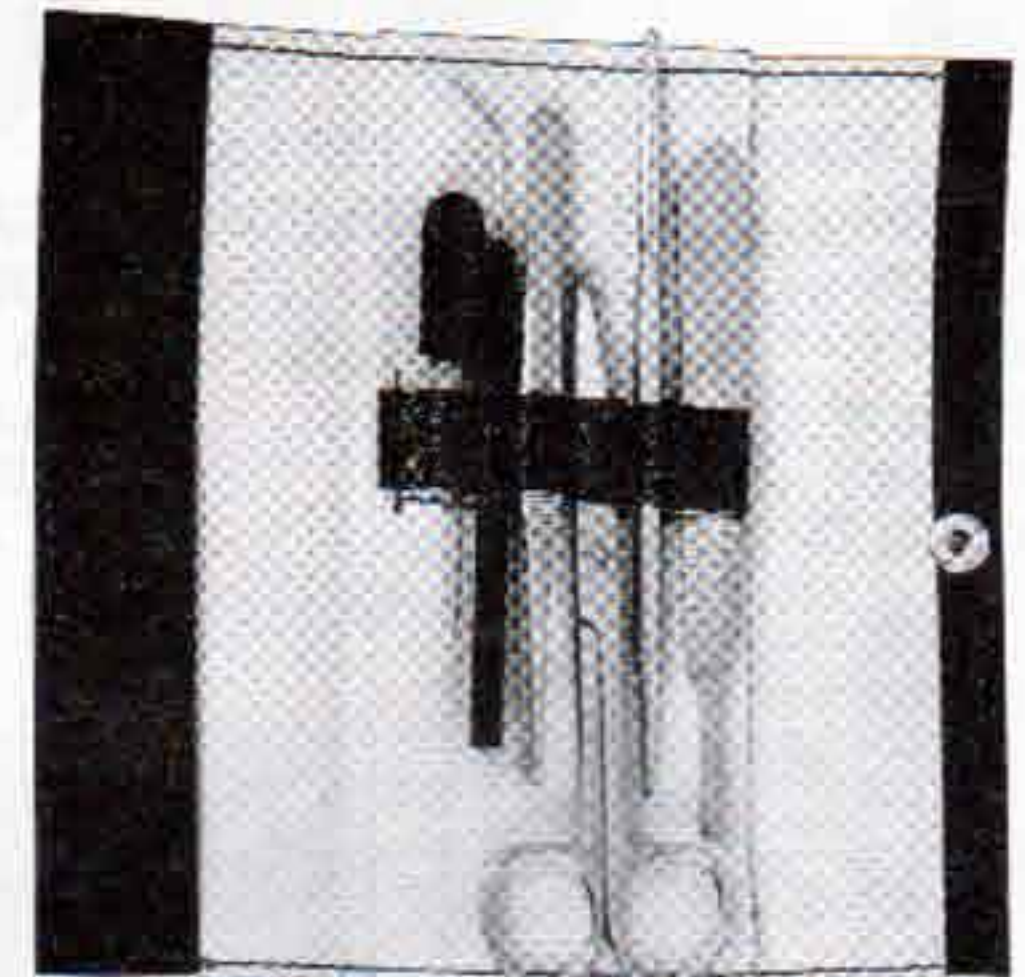

## 01-790

Set of 6 pcs.

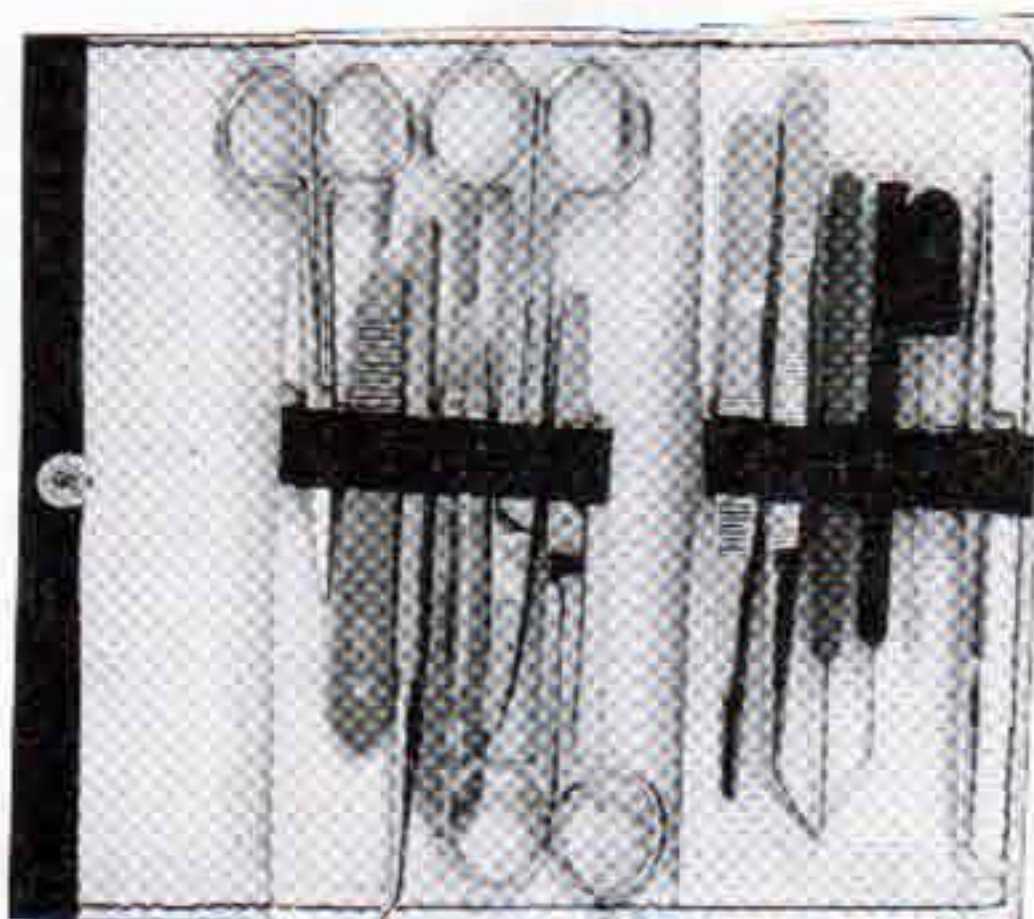

## 01-800

Set of 12 pcs.



## DISSECTING KET

01-810

Set of 2 pcs.



# SCALPEL HANDLES

Skalpellgriffe  
Mangos de bisturias

Manches pour bistouris  
Manici per bisturi

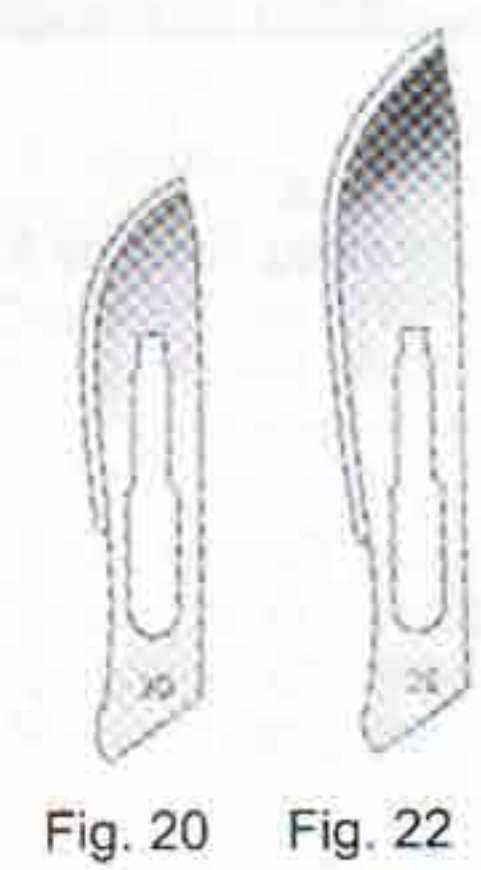
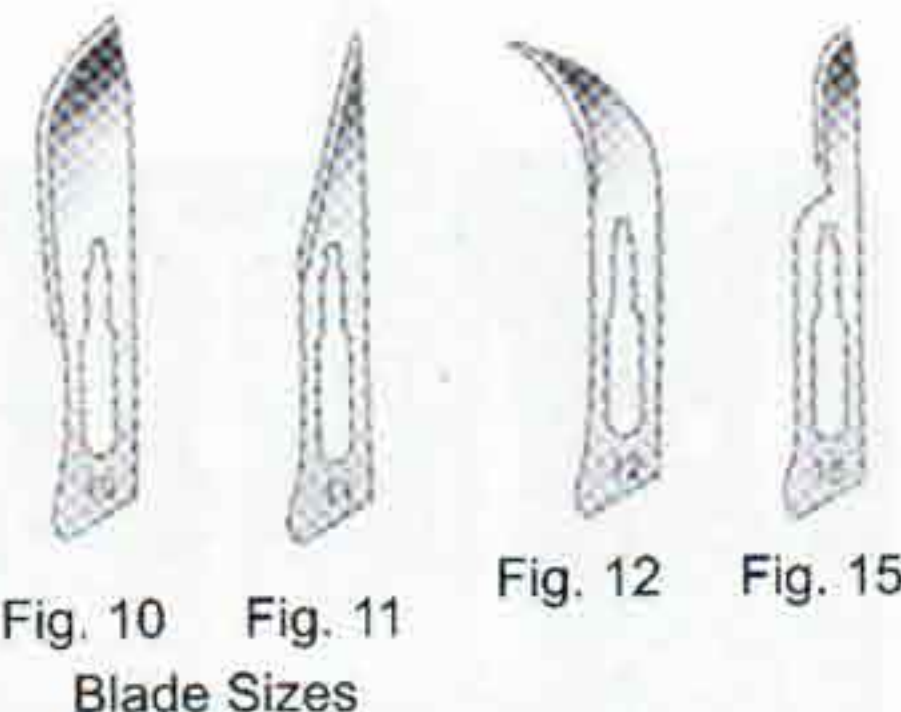

**#3 SCALPEL HANDLE**  
02-100  
12.75 cm, 5"  
Blade Size  
10, 11, 12, 15

**#3 SCALPEL HANDLE / GRADUATED**  
02-110  
12.75 cm, 5"  
Blade Size  
10, 11, 12, 15

**#4 SCALPEL HANDLE**  
02-120  
12.75 cm, 5"  
Blade Size  
20, 22, 25

**4L SCALPEL HANDLE**  
02-130  
21 cm, 8 1/4"

**SCALPEL PLASTIC HANDLE**  
02-140  
# 8

**COLLIN**  
02-150  
# 9

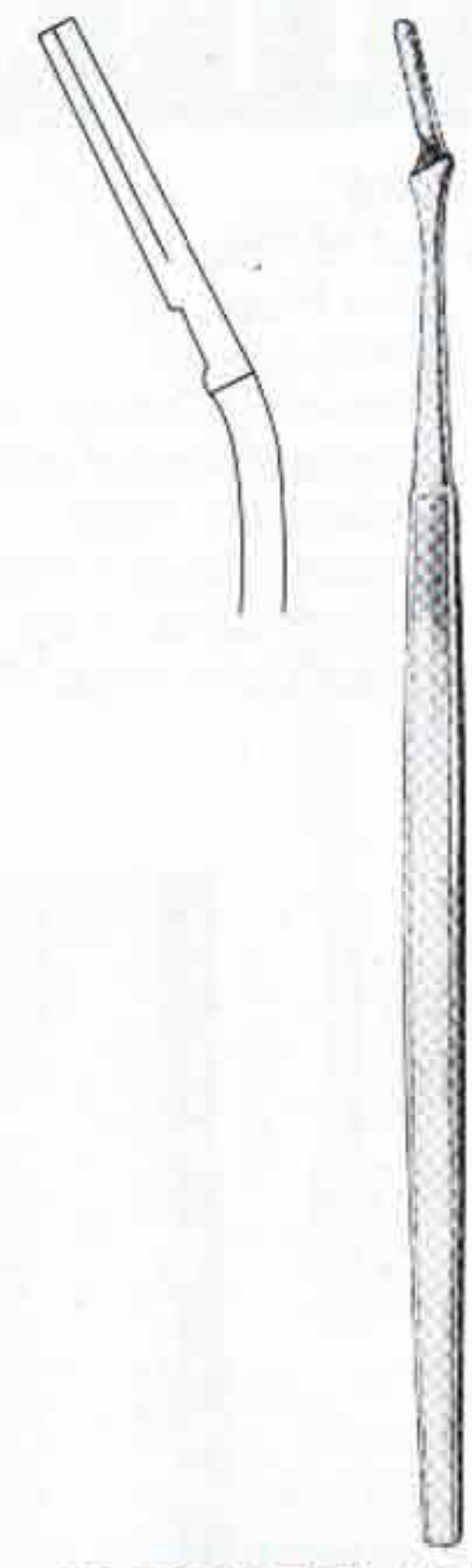

**SCALPEL PLASTIC HANDLE**  
02-160  
# 5

**SCALPEL PLASTIC HANDLE**  
02-170  
# 6

**#3, #4 SCALPEL HANDLE**  
02-180  
16 cm, 6"

**SCALPEL HANDLE 3L LONG**  
02-190 21 cm, 8 1/4"  
Blade Size 10, 11, 12, 15

**#7 SCALPEL HANDLE**  
02-200  
16.5 cm, 6 1/4"  
Blade 10, 11, 12, 15

**SCALPEL HANDLE 4L long**  
02-210  
21 cm, 8 1/4"

**#3 SCALPEL HANDLE / LONG ANGLED**  
02-220  
20.25 cm, 8 1/4"  
Blade Size 10, 11, 12, 15



# SCALPEL HANDLES

Skalpelligriffe  
Mangos de bisturías

Manches pour bistouris  
Manici per bisturi



**SCALPEL  
HANDLE**  
02-230  
16 cm, 6 1/4"



**SCALPEL  
HANDLE**  
02-240  
11.5 cm, 4 1/2"



**SCALPEL  
HANDLE**  
02-250  
12.7 cm, 5"



**SCALPEL  
HANDLE**  
02-260  
12.7 cm, 5"



**SCALPEL  
HANDLE**  
02-270  
11 cm, 4 1/4"



**SCALPEL  
HANDLE**  
02-280  
13.5 cm, 5 1/4"



**SCALPEL  
HANDLE**  
02-290  
12 cm, 4 3/4"



**TROUTMAN-CHRIS**  
02-300  
9 cm, 3 1/2"



**TROUTMAN-CHRIS**  
02-310  
9 cm, 3 1/2"



**BLADE HOLDER  
BLADE BREAKER**  
02-320  
11 cm, 4 1/4"



**CASTROVIEJO**  
02-330  
13 cm, 5 1/4"



# DISSECTING KNIVES

Anatomische skalpelle  
Bisturías para disección

Bistouris à dissection  
Bisturi para dissezione

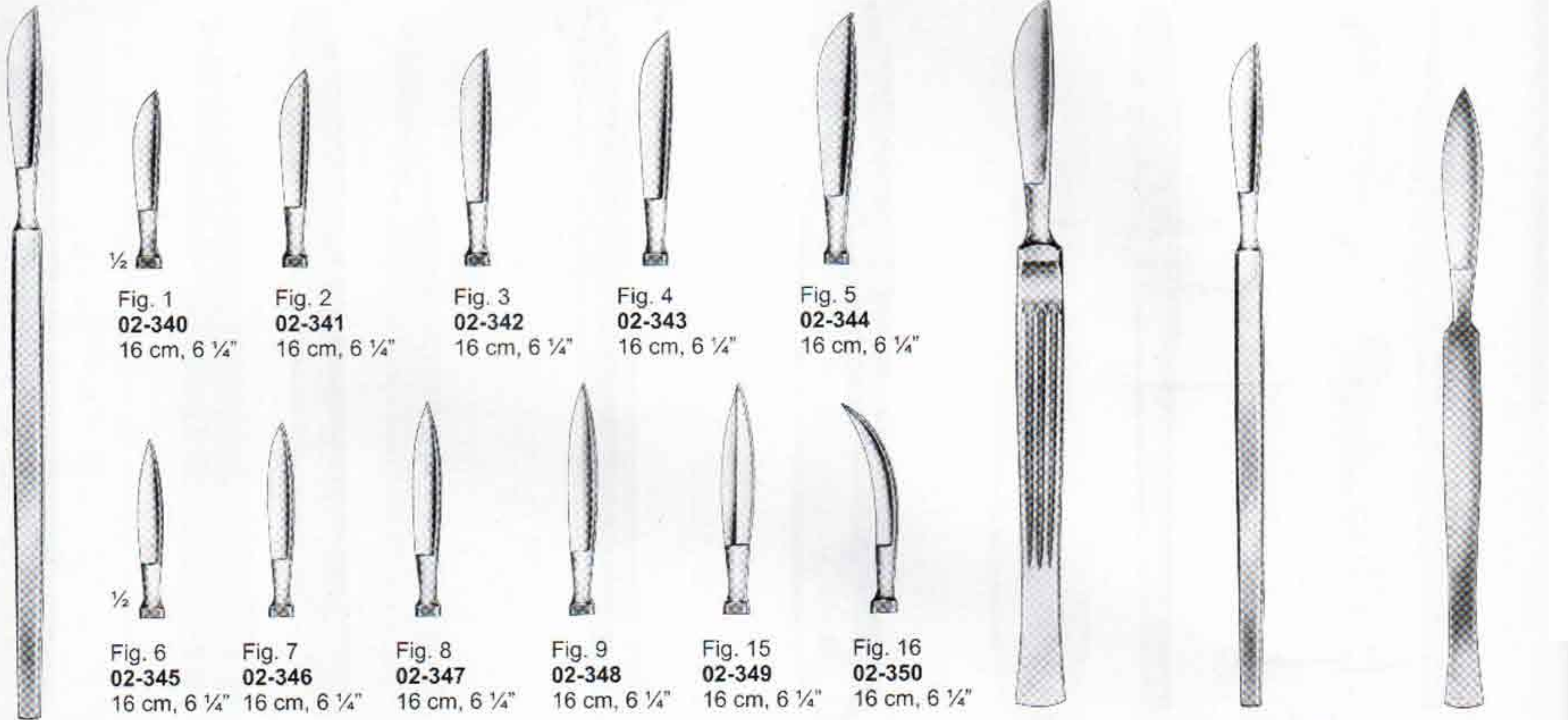

Fig. 1 02-340 16 cm, 6 1/4"  
 Fig. 2 02-341 16 cm, 6 1/4"  
 Fig. 3 02-342 16 cm, 6 1/4"  
 Fig. 4 02-343 16 cm, 6 1/4"  
 Fig. 5 02-344 16 cm, 6 1/4"  
 Fig. 6 02-345 16 cm, 6 1/4"  
 Fig. 7 02-346 16 cm, 6 1/4"  
 Fig. 8 02-347 16 cm, 6 1/4"  
 Fig. 9 02-348 16 cm, 6 1/4"  
 Fig. 15 02-349 16 cm, 6 1/4"  
 Fig. 16 02-350 16 cm, 6 1/4"

**DIEFFENBACH**  
16 cm, 6 1/4"

02-360  
17 cm, 6 3/4"

**DIEFFENBACH**  
02-370  
16 cm, 6 1/4"

**DISSECTING KNIFE**  
02-380 15 cm, 6"  
with metal handle

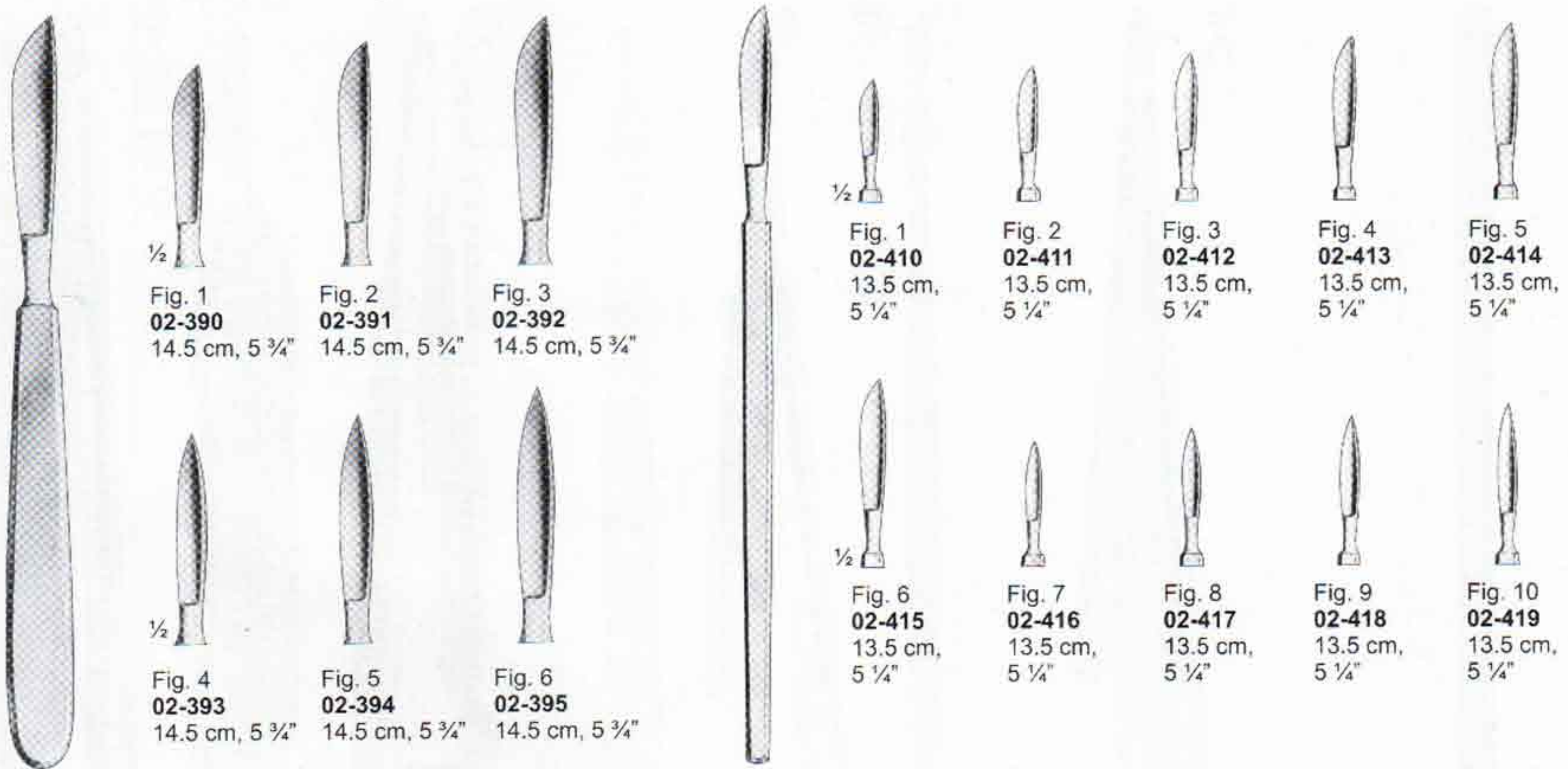

Fig. 1 02-390 14.5 cm, 5 3/4"  
 Fig. 2 02-391 14.5 cm, 5 3/4"  
 Fig. 3 02-392 14.5 cm, 5 3/4"  
 Fig. 4 02-393 14.5 cm, 5 3/4"  
 Fig. 5 02-394 14.5 cm, 5 3/4"  
 Fig. 6 02-395 14.5 cm, 5 3/4"  
 Fig. 1 02-410 13.5 cm, 5 1/4"  
 Fig. 2 02-411 13.5 cm, 5 1/4"  
 Fig. 3 02-412 13.5 cm, 5 1/4"  
 Fig. 4 02-413 13.5 cm, 5 1/4"  
 Fig. 5 02-414 13.5 cm, 5 1/4"  
 Fig. 6 02-415 13.5 cm, 5 1/4"  
 Fig. 7 02-416 13.5 cm, 5 1/4"  
 Fig. 8 02-417 13.5 cm, 5 1/4"  
 Fig. 9 02-418 13.5 cm, 5 1/4"  
 Fig. 10 02-419 13.5 cm, 5 1/4"

**COLLIN**  
14.5 cm, 5 3/4"

**DIEFFENBACH**  
13.5 cm



# DISSECTING KNIVES

Anatomische skalpelle  
Bisturías para disección

Bistouris à dissection  
Bisturi para dissezione



**02-430**  
17 cm, 6 3/4"



Fig. 1  
**02-431**  
17 cm, 6 3/4"



Fig. 3  
**02-432**  
17 cm, 6 3/4"



Fig. 5  
**02-433**  
17 cm, 6 3/4"



Fig. 7  
**02-434**  
17 cm, 6 3/4"



Fig. 9  
**02-435**  
17 cm, 6 3/4"



Fig. 10  
**02-436**  
17 cm, 6 3/4"



Fig. 12  
**02-437**  
17 cm, 6 3/4"



Fig. 14  
**02-438**  
17 cm, 6 3/4"



Fig. 16  
**02-439**  
17 cm, 6 3/4"



Fig. 18  
**02-440**  
17 cm, 6 3/4"



**DISSECTING KNIFE**  
15 cm, 6"  
with metal handle

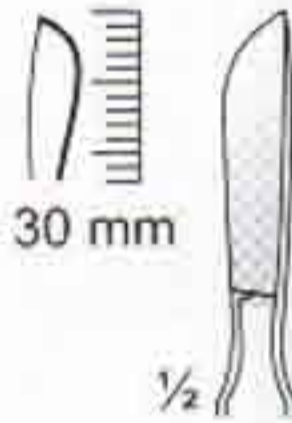

**02-450**  
15 cm, 6"

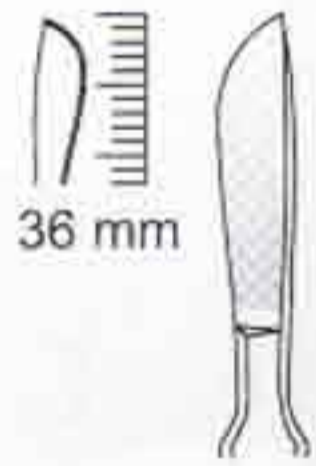

**02-451**  
15 cm, 6"

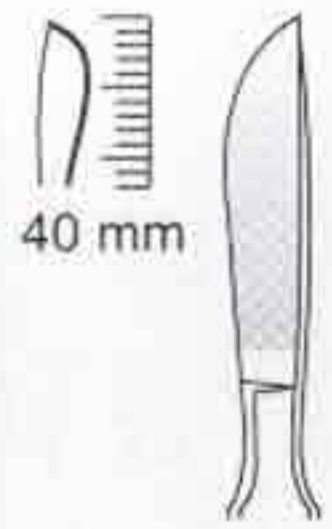

**02-452**  
15.5 cm, 6"

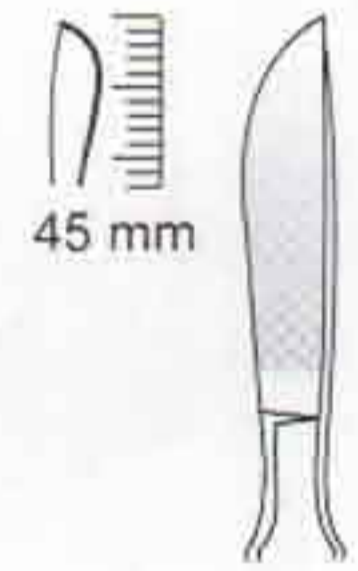

**02-453**  
16 cm, 6 1/4"

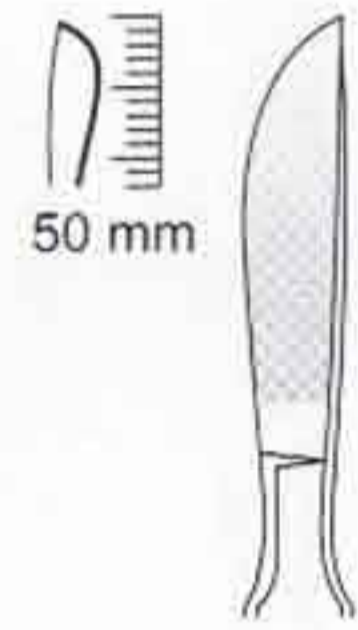

**02-454**  
16 cm, 6 1/4"

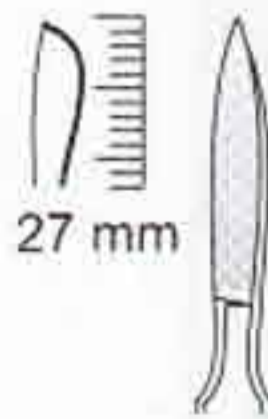

**02-455**  
15 cm, 6"

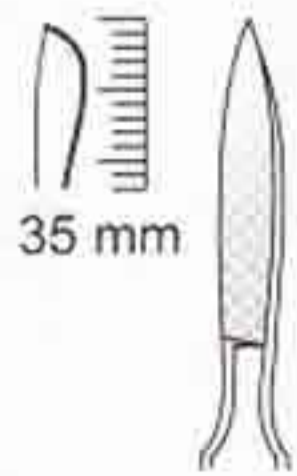

**02-456**  
15 cm, 6"

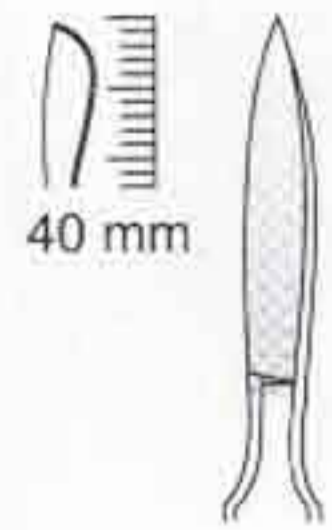

**02-457**  
16 cm, 6 1/4"

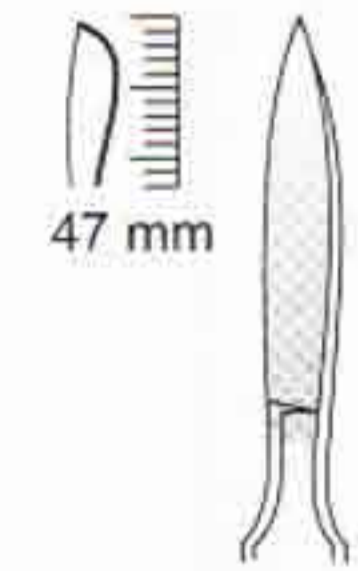

**02-458**  
16 cm, 6 1/4"

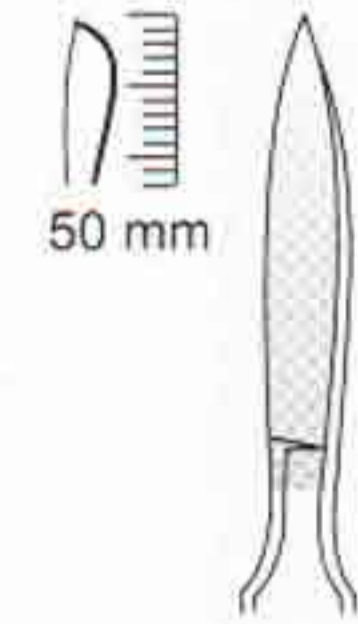

**02-459**  
17 cm, 6 3/4"



# DISSECTING KNIVES

Anatomische skalpelle  
Bisturías para disección

Bistouris à dissection  
Bisturi para dissezione

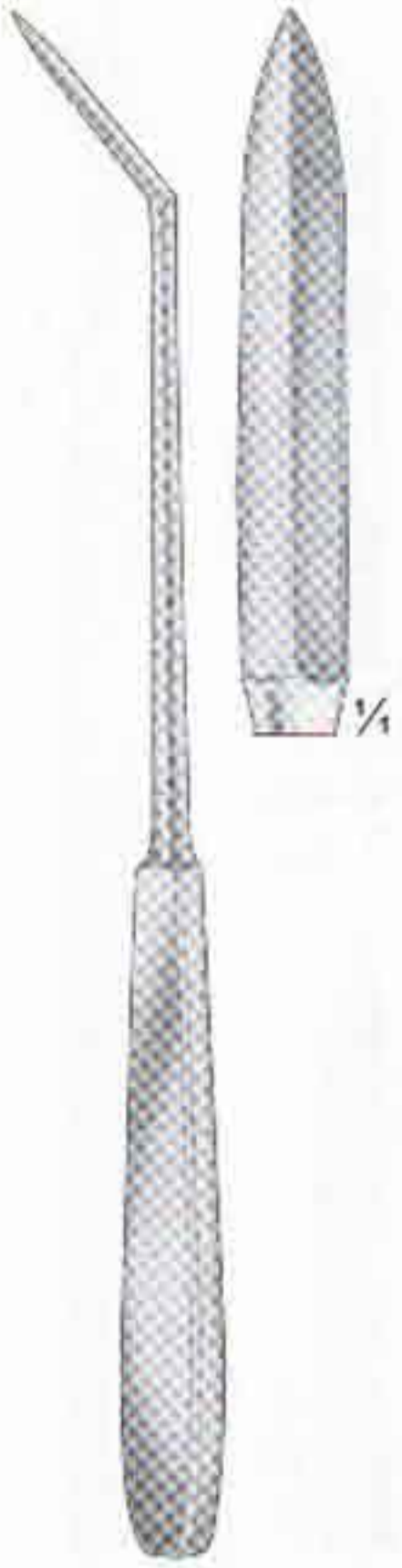

**AYRE**  
02-470  
23.5 cm, 9"  
Cone Knife

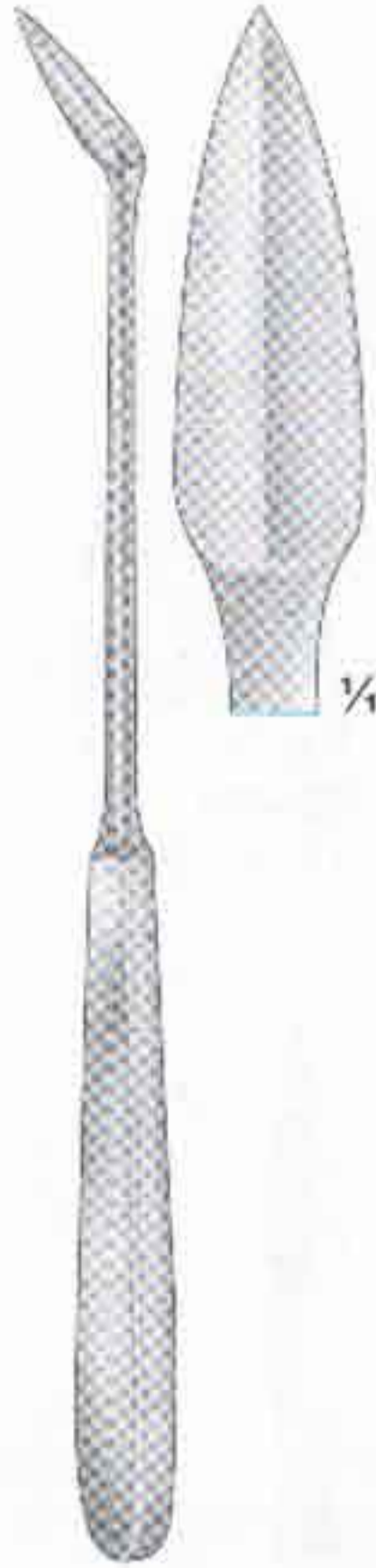

**02-480**  
23 cm, 9"  
Cone Knife



**SEGOND**  
02-490  
27 cm, 11"  
Myomatome



**OLIVECRONA**  
02-500  
20.5 cm, 8"  
Trigeminal knife



**02-510**  
23 cm, 9"  
Trigeminal knife



**FOWLER**  
02-520  
20 cm, 8"  
Tonsil knife



**ABRAHAM**  
02-530  
21.5 cm, 8 1/4"  
Tonsil knife



**BRUNINGS**  
02-540  
21.5 cm, 8 1/4"  
Tonsil knife



**DIEFFENBACH**  
02-550  
13 cm, 5"



**DIEFFENBACH**  
02-560  
13 cm, 5"



**SIMON**  
02-570  
23.5 cm, 9 1/4"



Fig. 1  
02-571



Fig. 2  
02-572



Fig. 3  
02-573



Fig. 4  
02-574



# DISSECTING KNIVES

Anatomische skalpelle  
Bisturías para disección

Bistouris à dissection  
Bisturi para dissezione



**DISSECTING KNIFE**  
**02-580**  
15 cm, 6"  
with metal handle



Fig.1



Fig.2



Fig.3



Fig.4



Fig.5



Fig.6



Fig.7



Fig.8



Fig.9



Fig.10



**RAZOR**  
**02-590**  
Hollow Blades On  
Both Sides  
**02-591**  
Blade Flat / Hollow



**COLLIN Blade**  
**02-600** 13 cm, 5"  
**02-601** 16 cm, 6 ¼"  
**02-602** 19 cm, 7 ½"  
**02-603** 22 cm, 8 ½"  
**02-604** 28 cm, 11 ¼"



**CATLIN Blade**  
**02-610** 16 cm, 6 ¼"  
**02-611** 19 cm, 7 ½"  
**02-612** 22 cm, 8 ½"



**LISTON Blade**  
**02-620** 16 cm, 6 ¼"  
**02-621** 19 cm, 7 ½"  
**02-622** 22 cm, 8 ½"



**LANGENBECK Blade**  
**02-630**  
12 cm, 4 ¾"



**RESECTION KNIFE**  
**02-640**  
18 cm, 7"



# AMPUTATION, RESECTION & DISSECTING KNIVES

Amputationsmesser, Cuchillos para amputación, Anatomische skalpelle  
 Couteaux à amputation, coltelli per amputazione, Bisturías para disección

Resektionsmesser, Cuchillos para resección, Bistouris à dissection  
 Couteaux à résection, Coltelli per resezione, Bisturi para dissezione



**COLLIN Blade**  
 02-660 13 cm, 5"  
 02-661 16 cm, 6 ¼"  
 02-662 19 cm, 7 ½"  
 02-663 22 cm, 8 ½"  
 02-664 28 cm, 11 ¼"



**CATLIN Blade**  
 02-670 16 cm, 6 ¼"  
 02-671 19 cm, 7 ½"  
 02-672 22 cm, 8 ½"  
 02-673 29 cm, 11 ½"



**LISTON Blade**  
 02-680 16 cm, 6 ¼"  
 02-681 19 cm, 7 ½"  
 02-682 22 cm, 8 ½"



**LANGENBECK Blade**  
 02-690  
 12 cm, 4 ¾"



**AMPUTATION KNIFE**  
 02-700  
 29 cm, 11 ½"  
 02-701  
 32.5 cm, 13"



**RESECTION KNIFE**  
 02-720  
 18 cm, 7"



**LANGENBECK**  
 02-730  
 18 cm, 7"



**LANGENBECK**  
 02-740  
 18 cm, 7"



**WALB**  
 02-750 11 cm, 4 ½"  
 02-751 14 cm, 5 ½"  
 02-752 17 cm, 6 ¾"



**VIRCHOW**  
 02-760 16 cm, 6 ¼"  
 02-761 20 cm, 8"  
 02-762 24 cm, 9 ½"



# OPERATING SCISSORS

Chirurgische scheren  
Tijeras quirúrgicas

Ciseaux chirurgicaux  
Forbici per chirurgia



## ROUND PATTERN

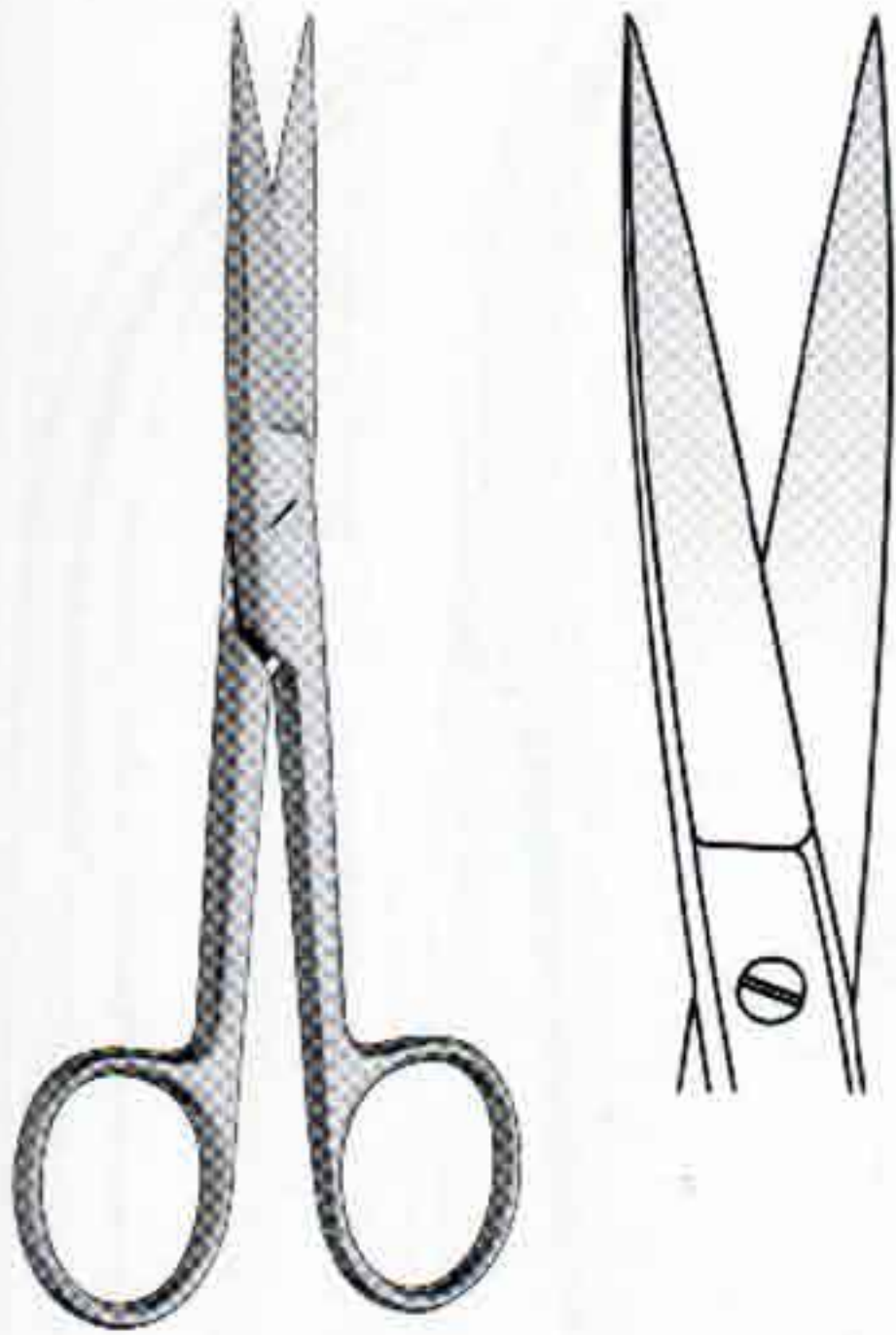

### STANDARD STRAIGHT

03-100	11.5 cm, 4 1/2"
03-101	13.0 cm, 5"
03-102	14.0 cm, 5 1/2"
03-103	15.0 cm, 6"
03-104	16.0 cm, 6 1/4"
03-105	17.5 cm, 7"
03-106	18.5 cm, 7 1/4"
03-107	20.0 cm, 8"

S/S Str.

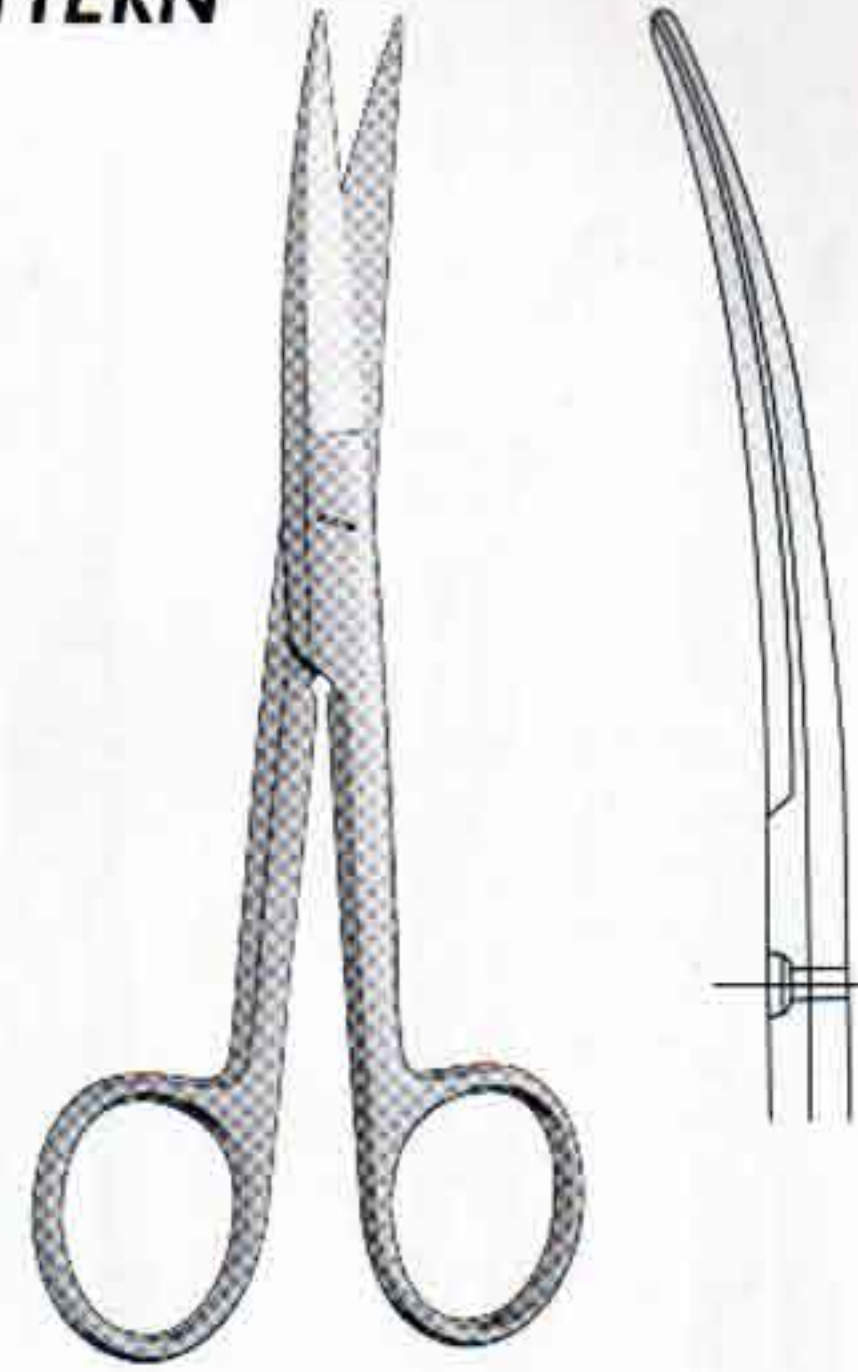

### STANDARD CURVED

03-120	11.5 cm, 4 1/2"
03-121	13.0 cm, 5"
03-122	14.0 cm, 5 1/2"
03-123	15.0 cm, 6"
03-124	16.0 cm, 6 1/4"
03-124	17.5 cm, 7"
03-125	18.5 cm, 7 1/4"
03-126	20.0 cm, 8"

S/S Cvd.



### STANDARD STRAIGHT

03-140	11.5 cm, 4 1/2"
03-141	13.0 cm, 5"
03-142	14.0 cm, 5 1/2"
03-143	15.0 cm, 6"
03-144	16.0 cm, 6 1/4"
03-145	17.5 cm, 7"
03-146	18.5 cm, 7 1/4"
03-147	20.0 cm, 8"

B/B Str.

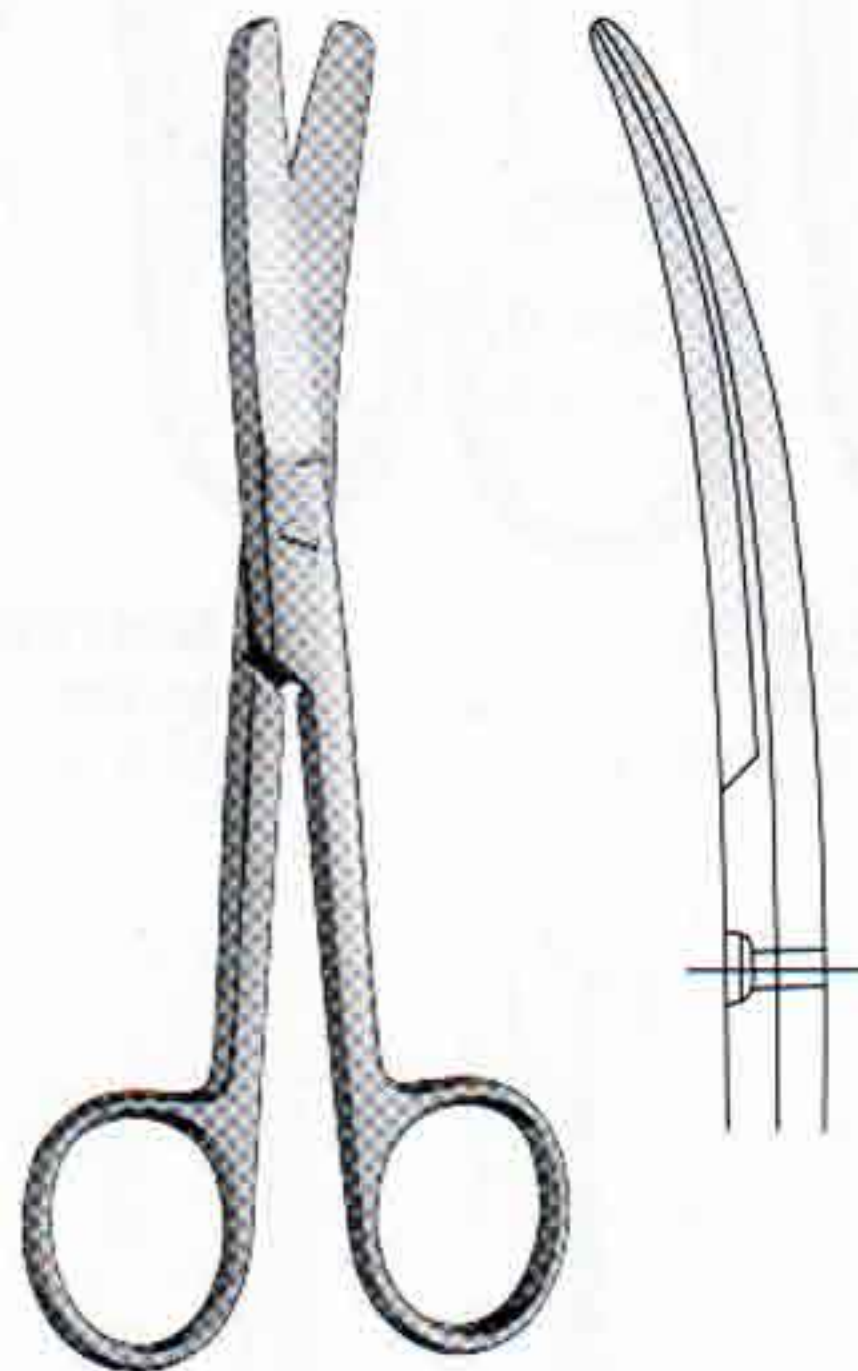

### STANDARD CURVED

03-160	11.5 cm, 4 1/2"
03-161	13.0 cm, 5"
03-162	14.0 cm, 5 1/2"
03-163	15.0 cm, 6"
03-164	16.0 cm, 6 1/4"
03-165	17.5 cm, 7"
03-166	18.5 cm, 7 1/4"
03-167	20.0 cm, 8"

B/B Cvd.

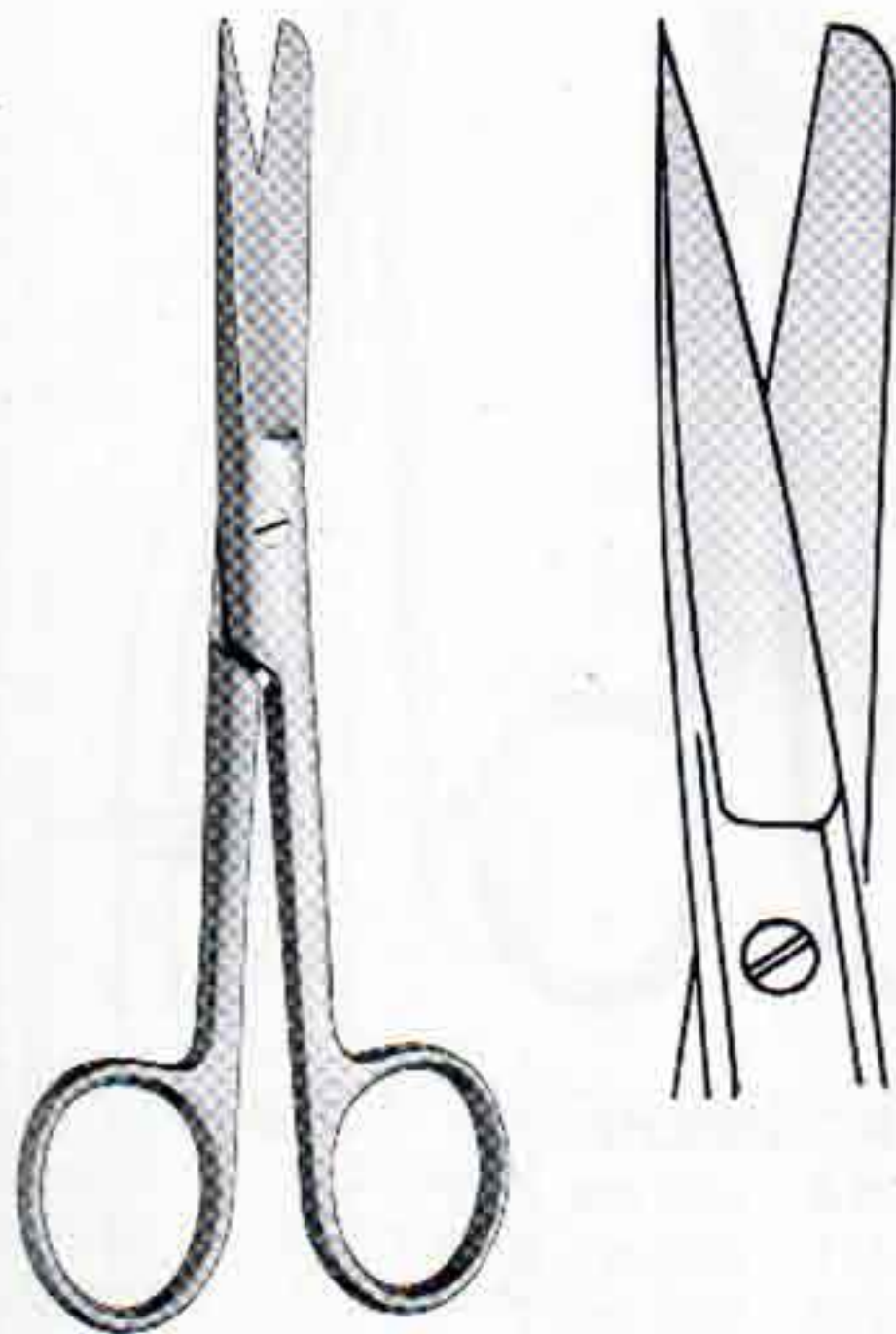

### STANDARD STRAIGHT

03-180	11.5 cm, 4 1/2"
03-181	13.0 cm, 5"
03-182	14.0 cm, 5 1/2"
03-183	15.0 cm, 6"
03-184	16.0 cm, 6 1/4"
03-185	17.5 cm, 7"
03-186	18.5 cm, 7 1/4"
03-187	20.0 cm, 8"

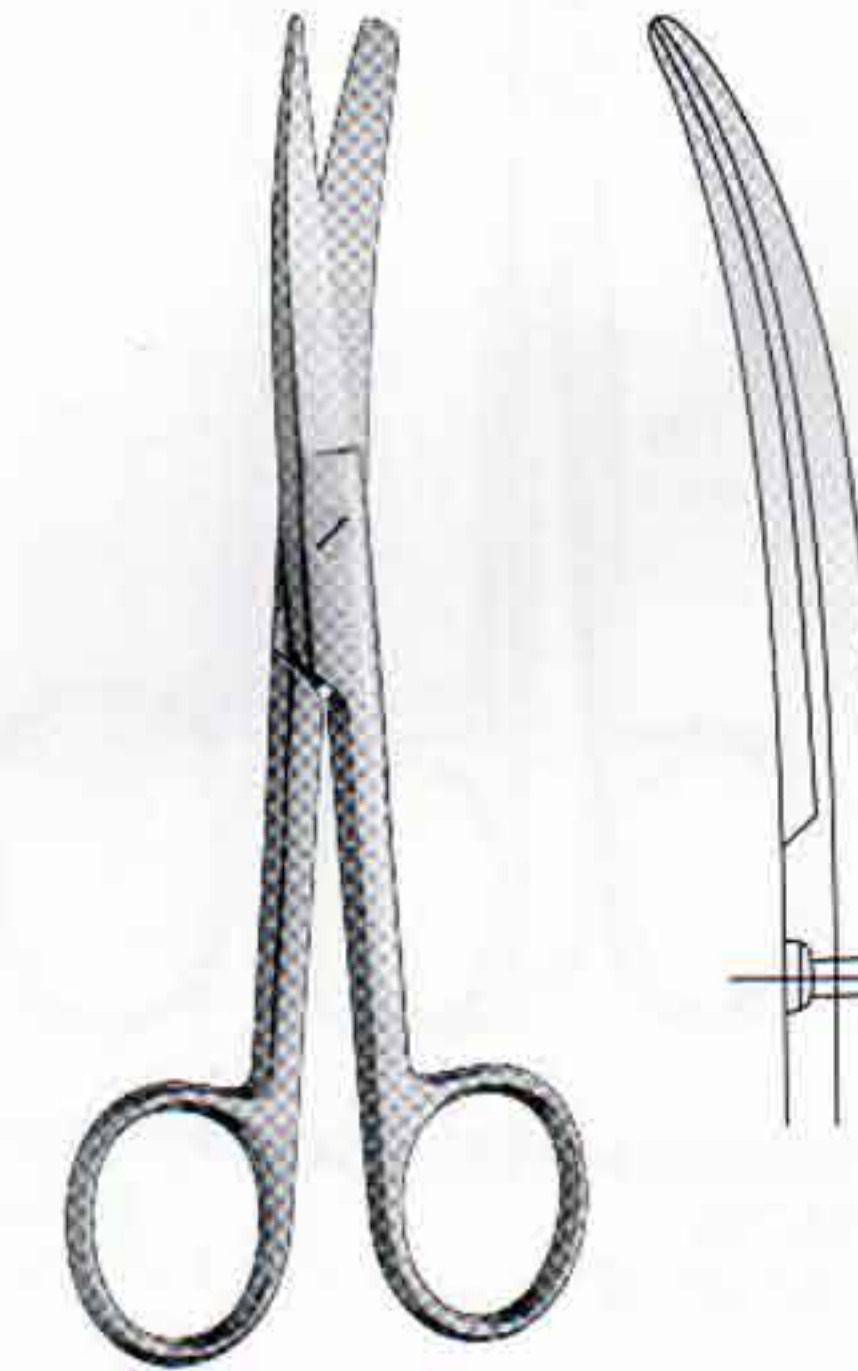

### STANDARD CURVED

03-200	11.5 cm, 4 1/2"
03-201	13.0 cm, 5"
03-202	14.0 cm, 5 1/2"
03-203	15.0 cm, 6"
03-204	16.0 cm, 6 1/4"
03-205	17.5 cm, 7"
03-206	18.5 cm, 7 1/4"
03-207	20.0 cm, 8"



# OPERATING, DISSECTING SCISSORS

Chirurgische scheren, Präparierscheren  
Tijeras quirúrgicas, Tijeras de disección

Ciseaux chirurgicaux, Ciseaux à dissection  
Forbici per chirurgia, Forbici per dissezione

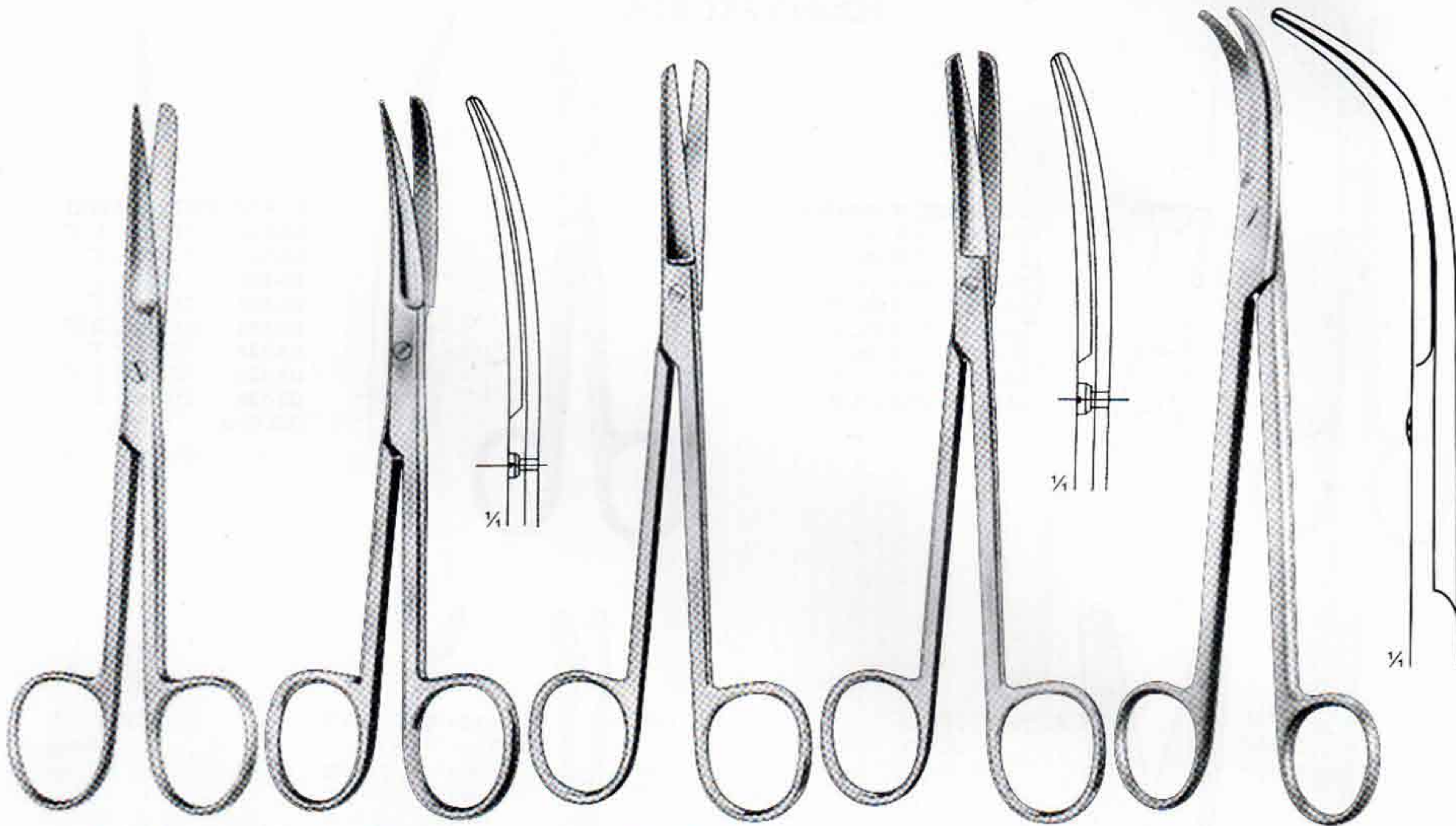

**DEAVER**  
03-220  
14.0 cm, 5 ½"

**DEAVER**  
03-230  
14.0 cm, 5 ½"

**MIXTER**  
03-240  
15.5 cm, 6"

**MIXTER**  
03-250  
15.5 cm, 6"

**JORGENSON**  
03-260  
22 cm, 8 ½"  
Curved



**INCISION SCISSORS**  
03-270 13.0 cm, 5"  
03-271 14.5 cm, 5 ½"

**INCISION SCISSORS**  
03-280  
15.5 cm, 6"

**RICHTER**  
03-290  
14.5 cm, 5 ½"

**FERGUSSON**  
03-300 14.0 cm, 5 ½"  
03-311 16.5 cm, 6 ½"  
03-312 18.0 cm, 7"



# OPERATING & DISSECTING SCISSORS

Chirurgische scheren, Präparierscheren  
Tijeras quirúrgicas, Tijeras de disección

Ciseaux chirurgicaux, Ciseaux à dissection  
Forbici per chirurgia, Forbici per dissezione



**03-323** 14.5 cm, 5 1/2"  
**03-324** 15.0 cm, 6"  
**03-325** 17.0 cm, 6 3/4"

**03-342** 15.0 cm, 6"  
**03-343** 17.0 cm, 6 3/4"  
Cvd.

**03-351** 17.0 cm, 6 3/4"  
Cvd.

**03-360** 14.5 cm, 5 3/4"  
**03-361** 18.0 cm, 7"  
**03-362** 20.0 cm, 8"  
**03-363** 23.0 cm, 9"  
**03-364** 25.0 cm, 10"  
**03-365** 28.0 cm, 11"  
Str. & Cvd.

**03-380** 14.5 cm, 5 3/4"  
**03-381** 18.0 cm, 7"  
**03-382** 20.0 cm, 8"  
**03-383** 23.0 cm, 9"  
**03-384** 25.0 cm, 10"  
**03-385** 28.0 cm, 11"  
Str. & Cvd.

**MAYO Str.**  
**03-320** 14.5 cm, 5 1/2"  
**03-321** 15.0 cm, 6"  
**03-322** 17.0 cm, 6 3/4"

**MAYO-STILLE**  
**03-340** 15.0 cm, 6"  
**03-341** 17.0 cm, 6 3/4"  
Str.

**MAYO-NOBLE**  
**03-350** 17.0 cm, 6 3/4"  
Str.

**METZENBAUM**  
Blunt / Blunt

**METZENBAUM NELSON**



Blade length  
6.4 cm  
5.1 cm  
4.4 cm



**03-421** 11.5 cm, 4 1/2"  
Cvd.

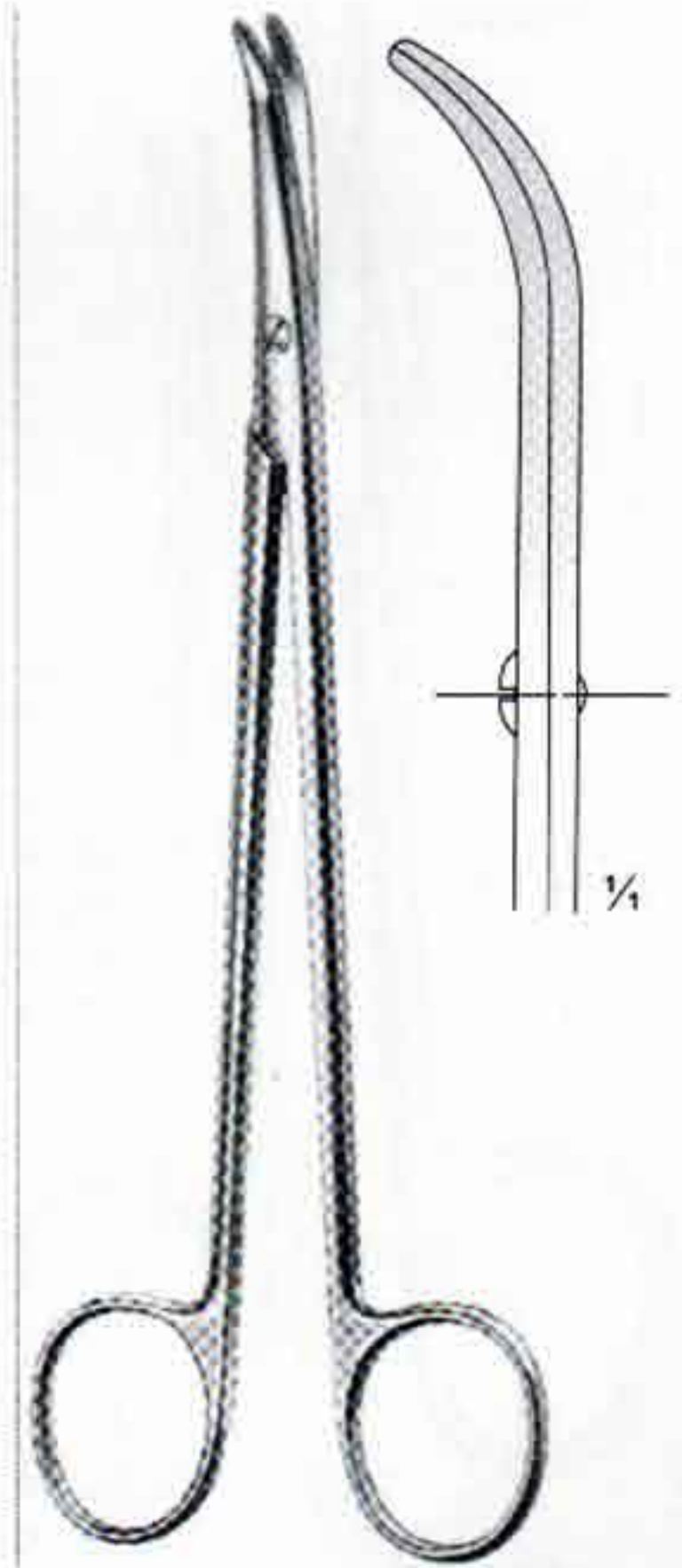

**METZENBAUM DISSECTING**  
**03-400** 20.3 cm, 8"  
**03-401** 22.9 cm, 9"  
**03-402** 28.4 cm, 11"  
Curved

**METZENBAUM-JAMISON**  
**03-410** 15.25 cm, 6"

**METZENBAUM-BABY**  
**03-420** 11.5 cm, 4 1/2"  
Str.

**THOREK**  
**03-430** 19.0 cm, 7 1/2"



# FACE-LIFE, DISSECTING, NASAL SCISSORS & OPERATING

Face-lift, Präparierscheren, Nasenscheren, Chirurgische scheren  
 face-Lift, Tijeras de disección, Tijeras nasales, Tijeras quirúrgicas

Face-lift, Ciseaux à dissection, Ciseaux nasaux, Ciseaux chirurgicaux  
 Face-lift, Forbici per dissezione, Forbici nasali, Forbici per chirurgia

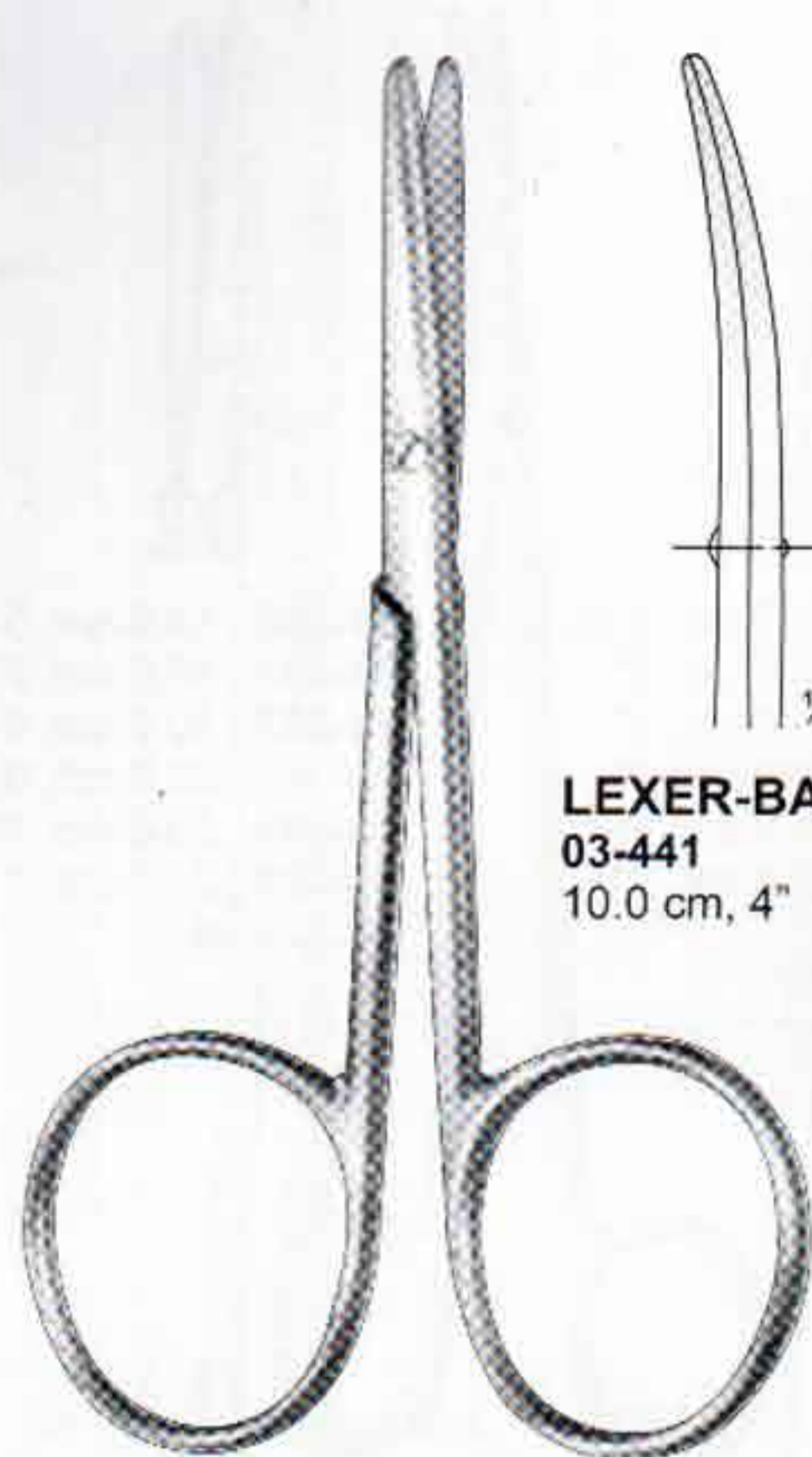

**LEXER-BABY**  
 03-441  
 10.0 cm, 4"

**LEXER-BABY**  
 03-440  
 10.0 cm, 4"

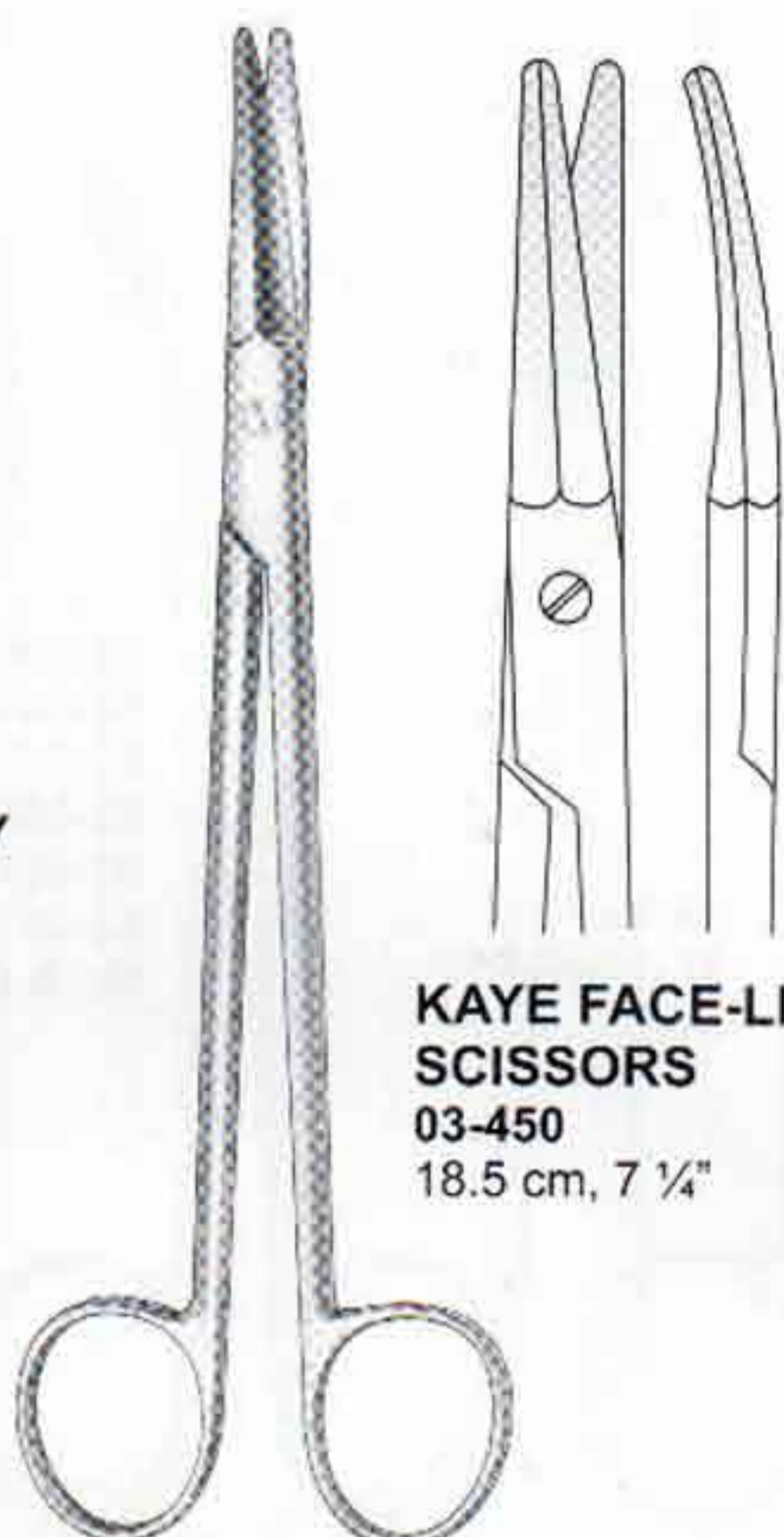

**KAYE FACE-LIFT SCISSORS**  
 03-450  
 18.5 cm, 7 1/4"

**KAYE FACE-LIFT SCISSORS**



**03-460**  
 13.5 cm, 5 1/4"

**FOMON**

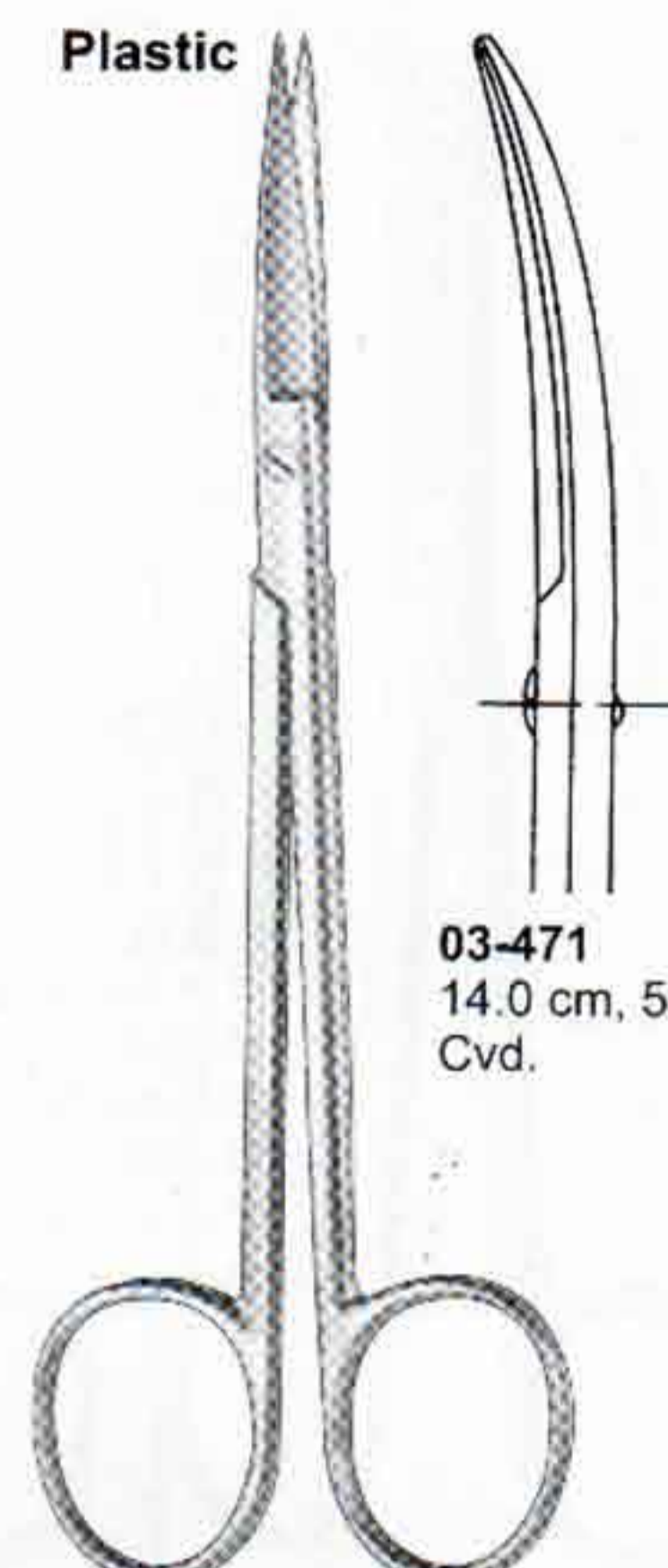

**03-471**  
 14.0 cm, 5 1/2"  
 Cvd.

**JOSEPH**  
 03-470  
 14.0 cm, 5 1/2"  
 Str.

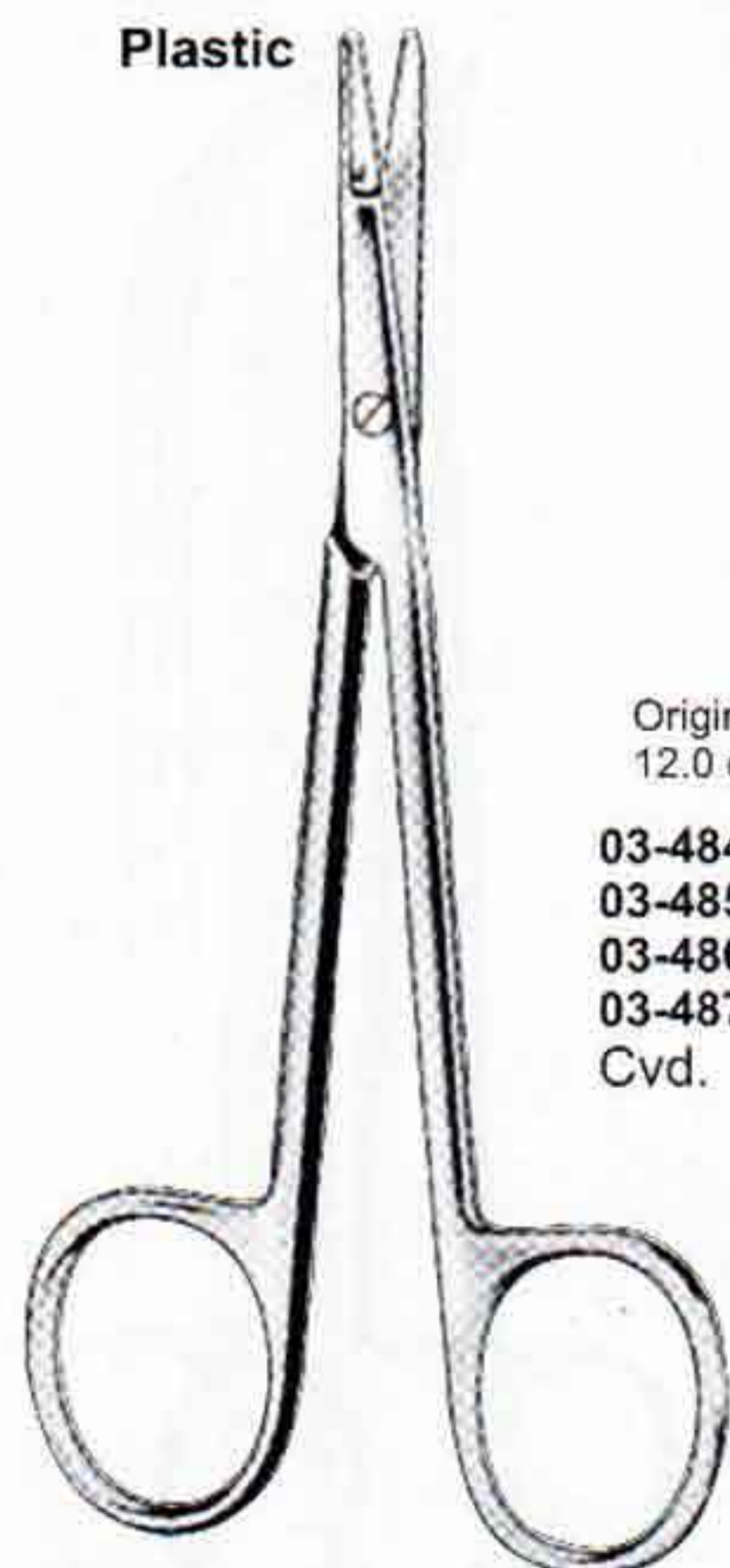

**KILNER**  
 03-480 12.0 cm, 4 3/4"  
 03-481 15.0 cm, 6"  
 03-482 18.0 cm, 7"  
 03-483 20.0 cm, 8"  
 Str.



Original  
 12.0 cm  
 03-484 12.0 cm, 4 3/4"  
 03-485 15.0 cm, 6"  
 03-486 18.0 cm, 7"  
 03-487 20.0 cm, 8"  
 Cvd.

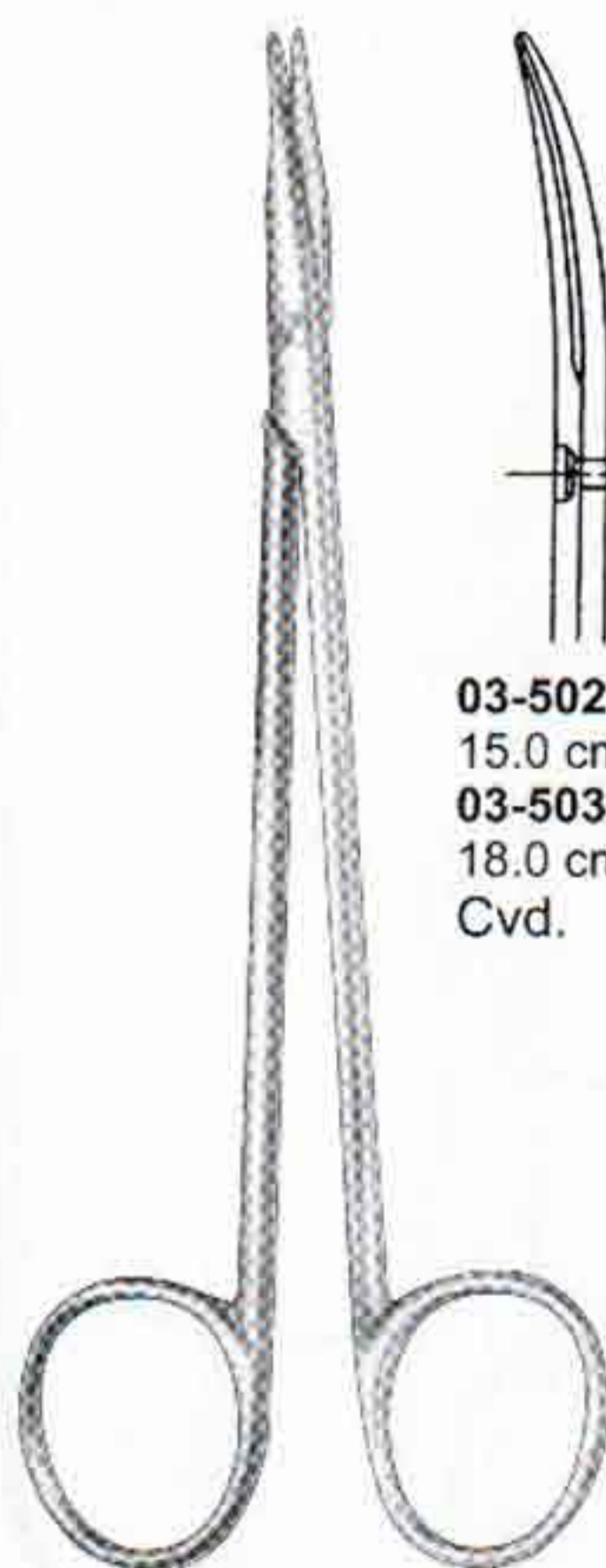

**REYNOLDS**  
 03-500 15.0 cm, 6"  
 03-501 18.0 cm, 7"  
 Str.

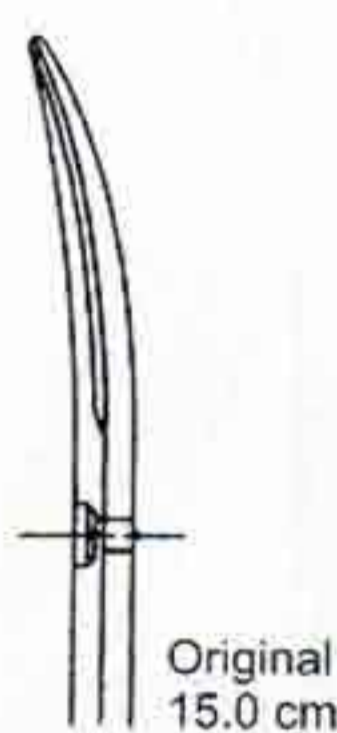

Original  
 15.0 cm  
 03-502 15.0 cm, 6"  
 03-503 18.0 cm, 7"  
 Cvd.

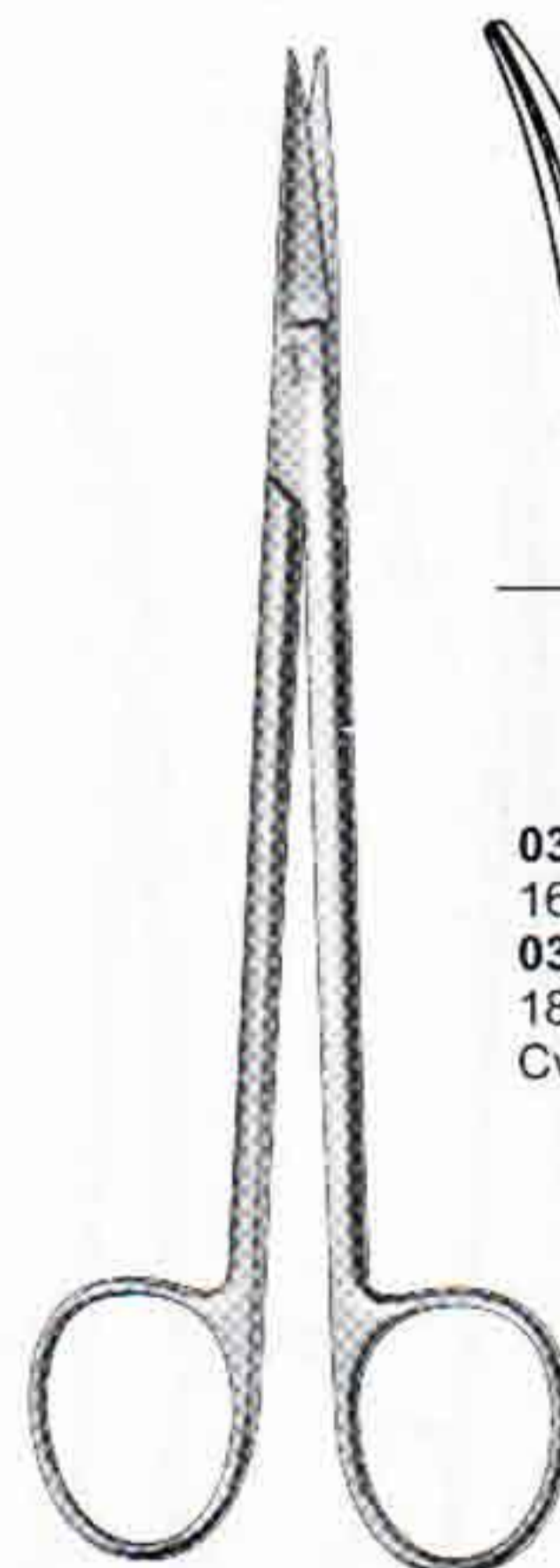

**KELLY**  
 03-510 16.0 cm, 6 1/4"  
 03-511 18.0 cm, 7"  
 Str.



03-512 16.0 cm, 6 1/4"  
 03-513 18.0 cm, 7"  
 Cvd.



# GYNECOLOGICAL, IRIS & TENDON SCISSORS



Gynäkologische Scheren, Irisscheren, Schnenscheren  
Tijeras para ginecología, Tijeras para Iridectomía, Tijeras para tendones

ciseaux à gynécologie, Ciseaux à iridectomie, Ciseaux à Ténotomie  
Forbici per ginecologia, Forbici per iridectomia, Forbici per tenotomia



**DOYEN**  
**03-520**  
16.0 cm, 6 1/4"  
S/B, Str.

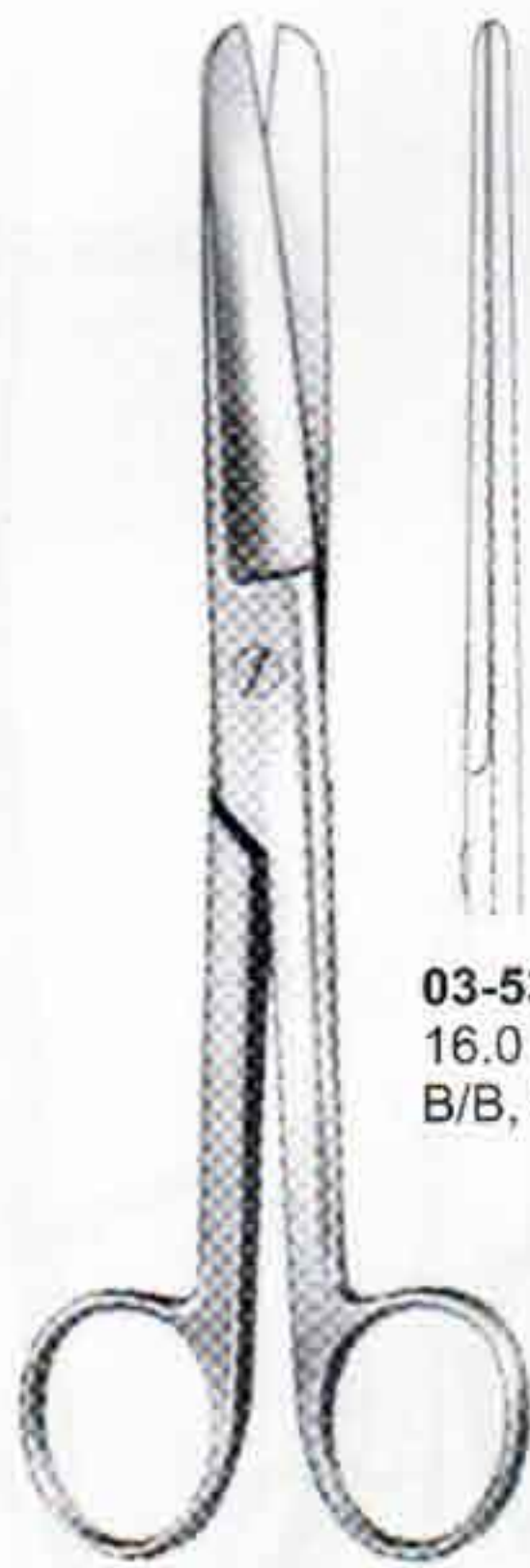

**DOYEN**  
**03-530**  
16.0 cm, 6 1/4"  
B/B, Str.

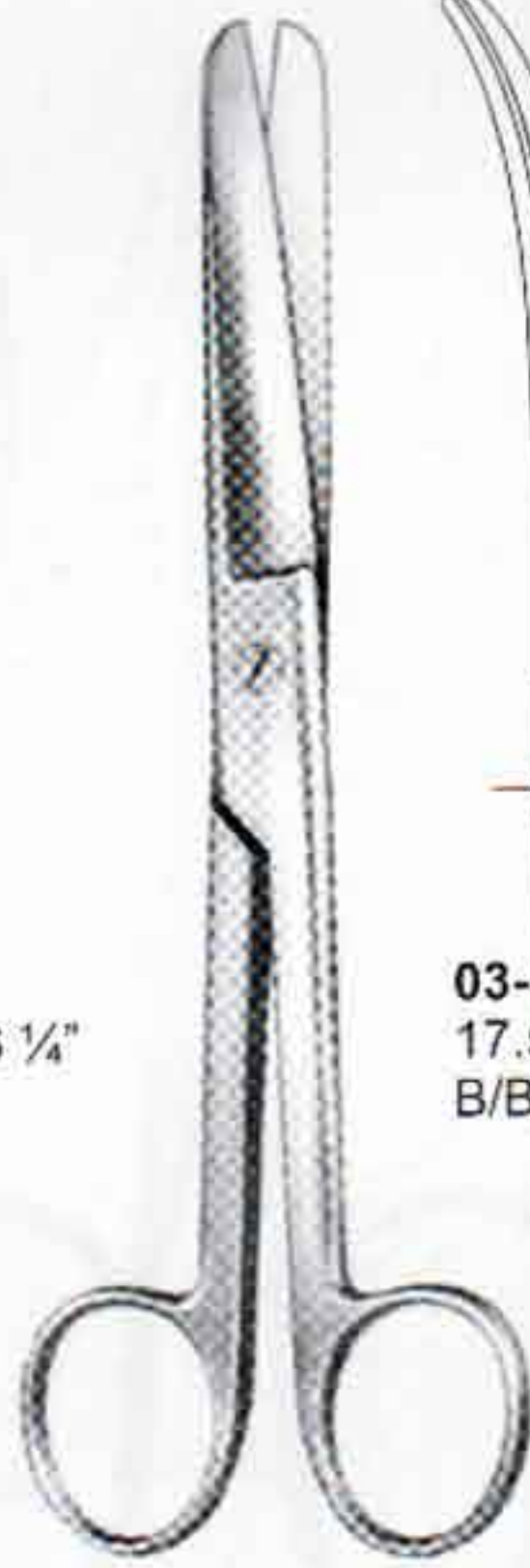

**DOYEN**  
**03-540**  
17.5 cm, 6 3/4"  
B/B, Str.

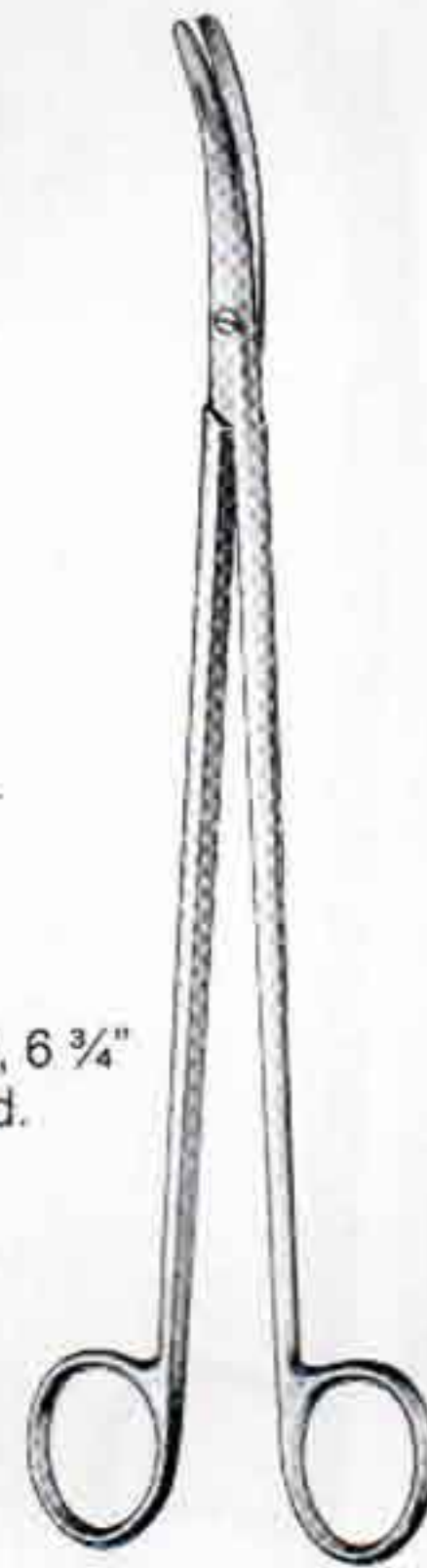

**CARDINALE**  
**03-550**  
28.0 cm, 11"

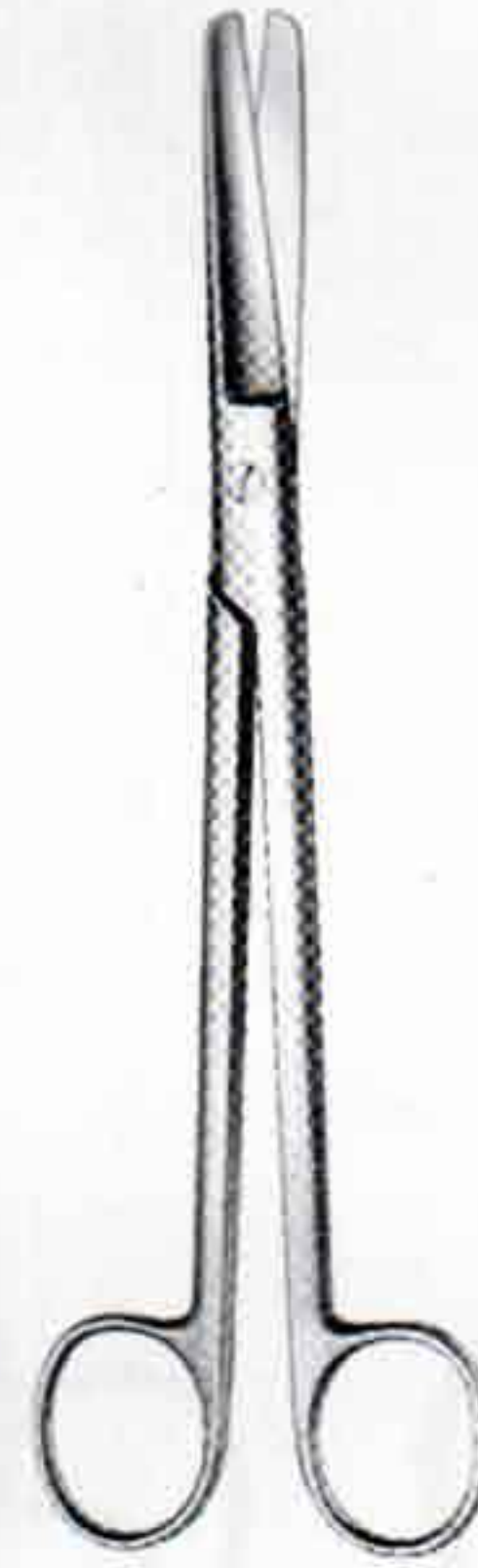

**SIMS**  
**03-551** 20.0 cm, 8"  
**03-552** 23.0 cm, 9"  
Straight, B/B



**03-553**  
20.0 cm, 8"  
**03-554**  
23.0 cm, 9"  
S/B



**03-555**  
20.0 cm, 8"  
**03-556**  
23.0 cm, 9"  
S/S



**03-557**  
20.0 cm, 8"  
**03-558**  
23.0 cm, 9"  
S/B



**03-559**  
20.0 cm, 8"  
**03-560**  
23.0 cm, 9"  
S/S



**03-570** 09 cm, 3 1/2"  
**03-571** 10.5 cm, 4 1/4"  
**03-572** 11.5 cm, 4 1/2"  
**03-573** 12.0 cm, 4 3/4"  
Str.



**03-574** 09 cm, 3 1/2"  
**03-575** 10.5 cm, 4 1/4"  
**03-576** 11.5 cm, 4 1/2"  
**03-577** 12.0 cm, 4 3/4"  
Cvd.

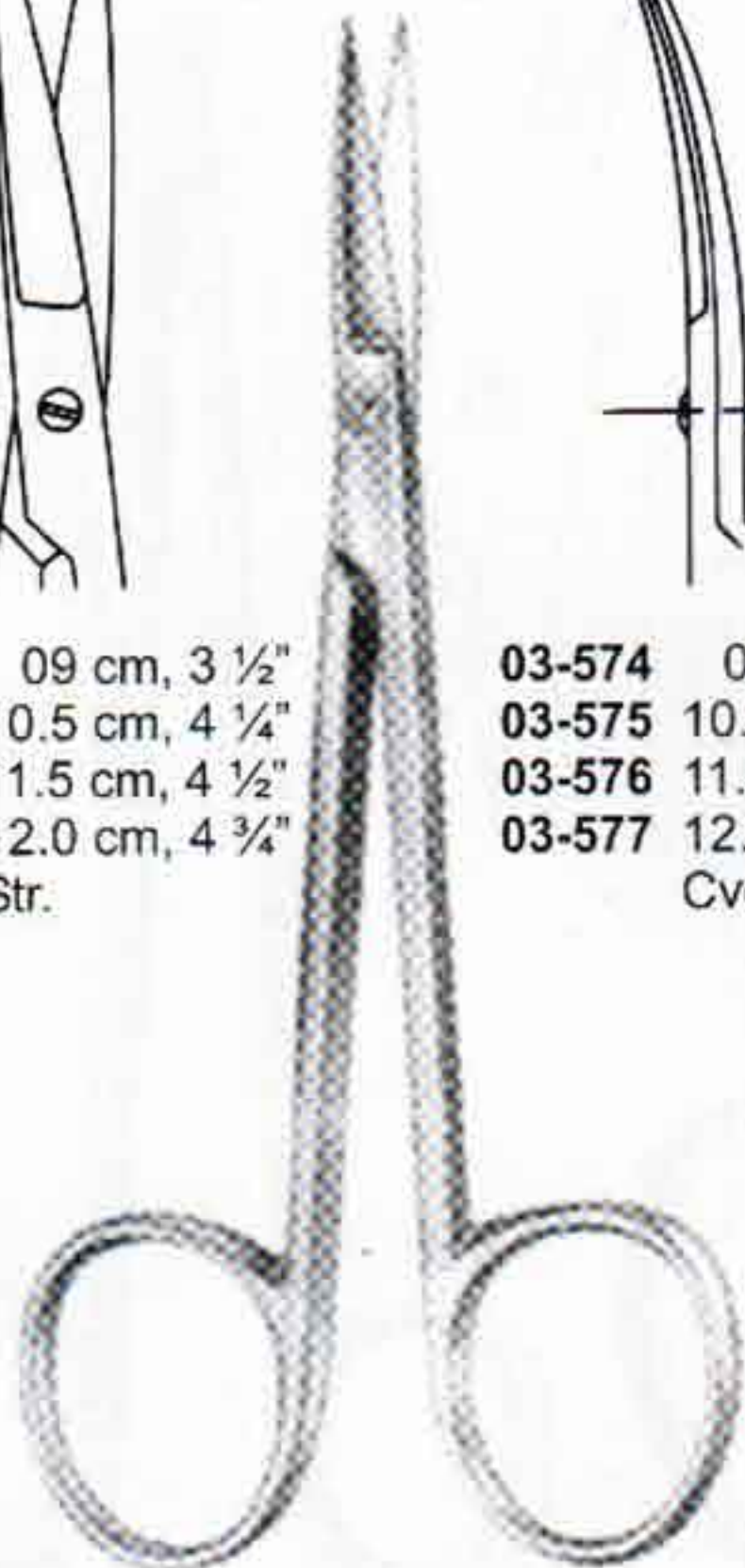

**IRIS SCISSORS**

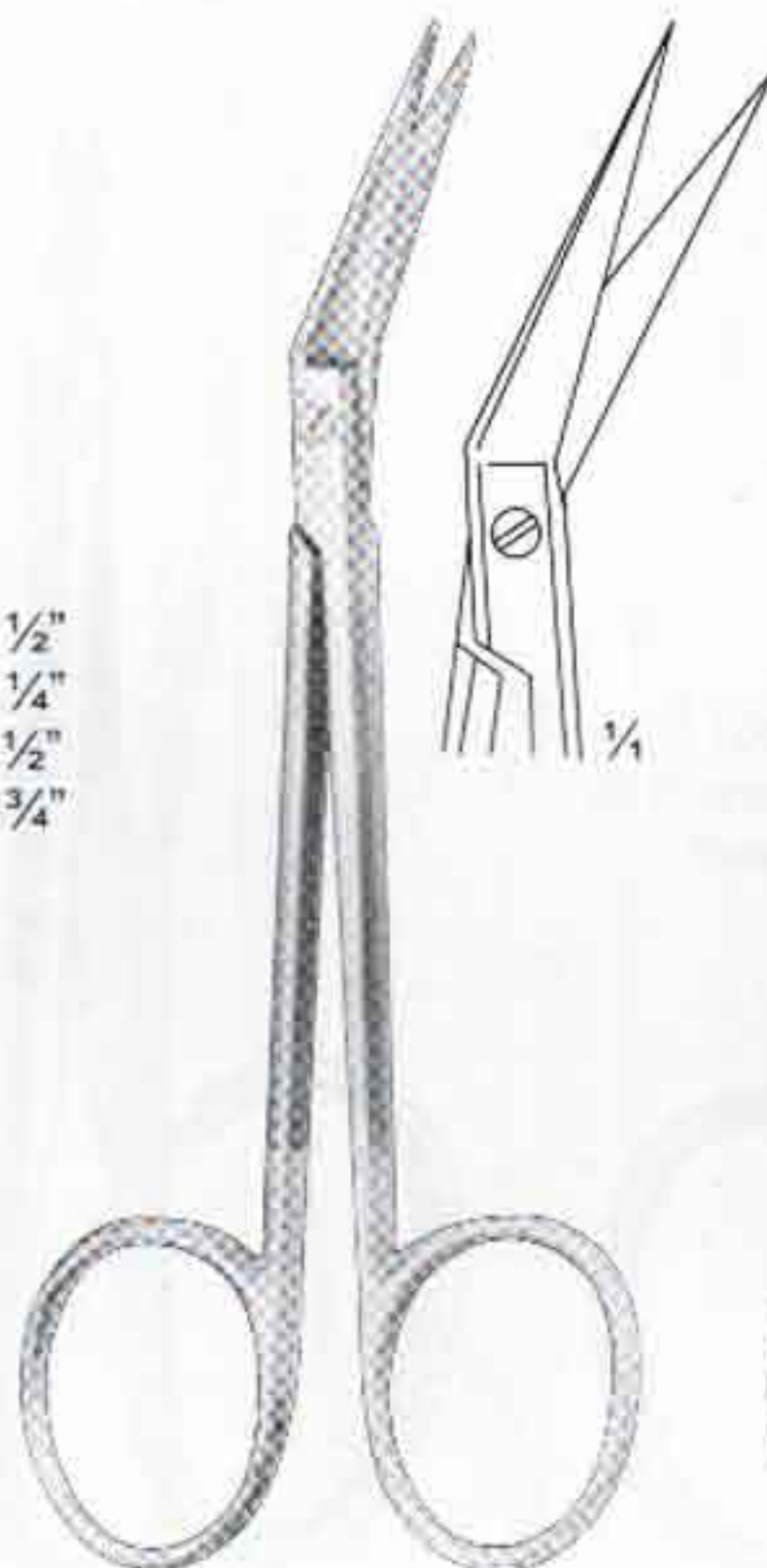

**IRIS ANGULAR**  
**03-590**  
11cm 4 1/4"



**03-600**  
11.5 cm, 4 1/2"  
Straight,  
sharp/sharp

**KILLNER**

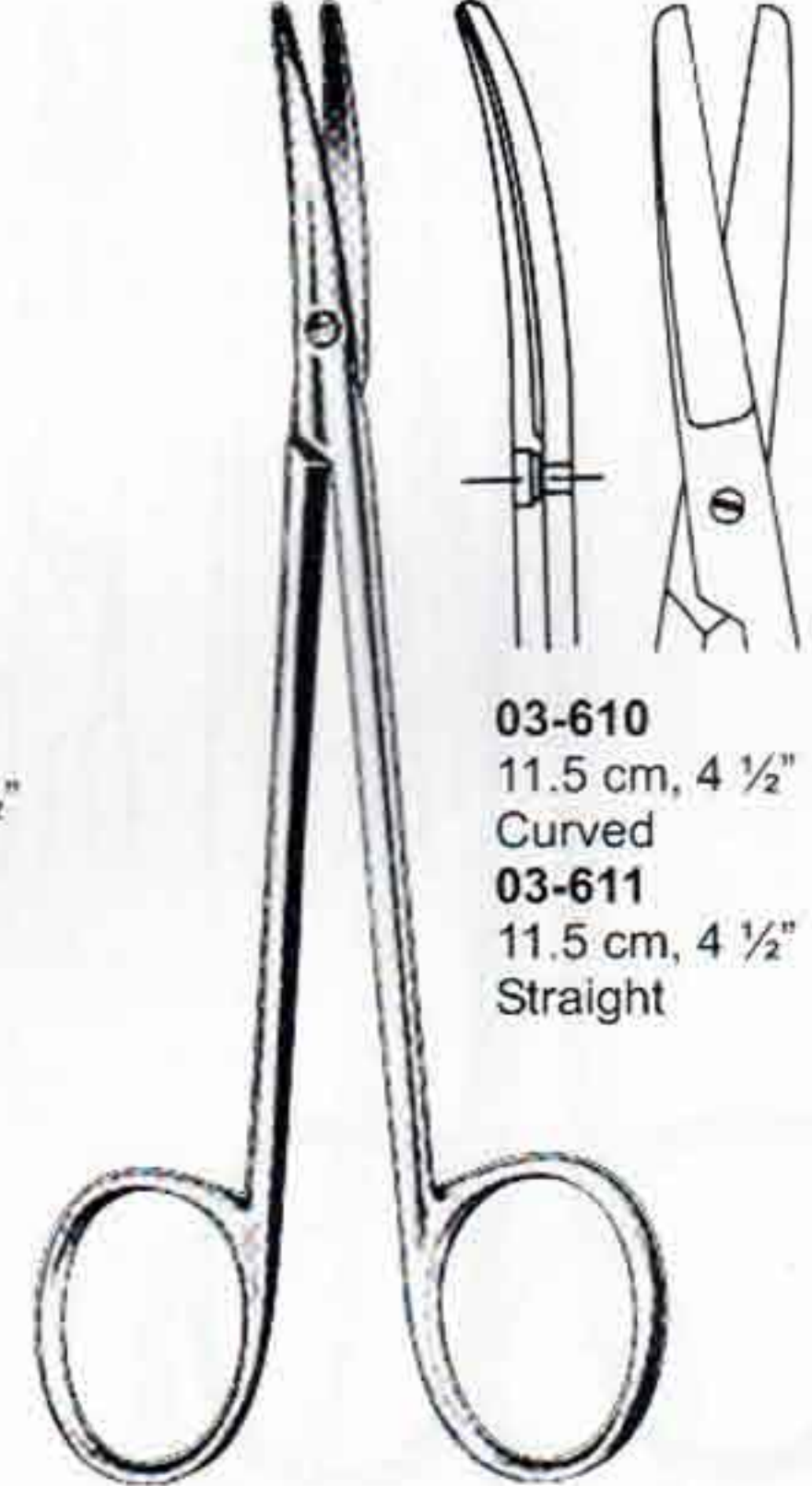

**03-610**  
11.5 cm, 4 1/2"  
Curved  
**03-611**  
11.5 cm, 4 1/2"  
Straight

**STRABISMUS**



# DISSECTING & VASCULAR SCISSORS

Präparierscheren, Gefäßscheren  
Tijeras de disección, Tijeras vasculares

Ciseaux à dissection, Ciseaux vasculaires  
Forbici per dissezione, Forbici vascolari

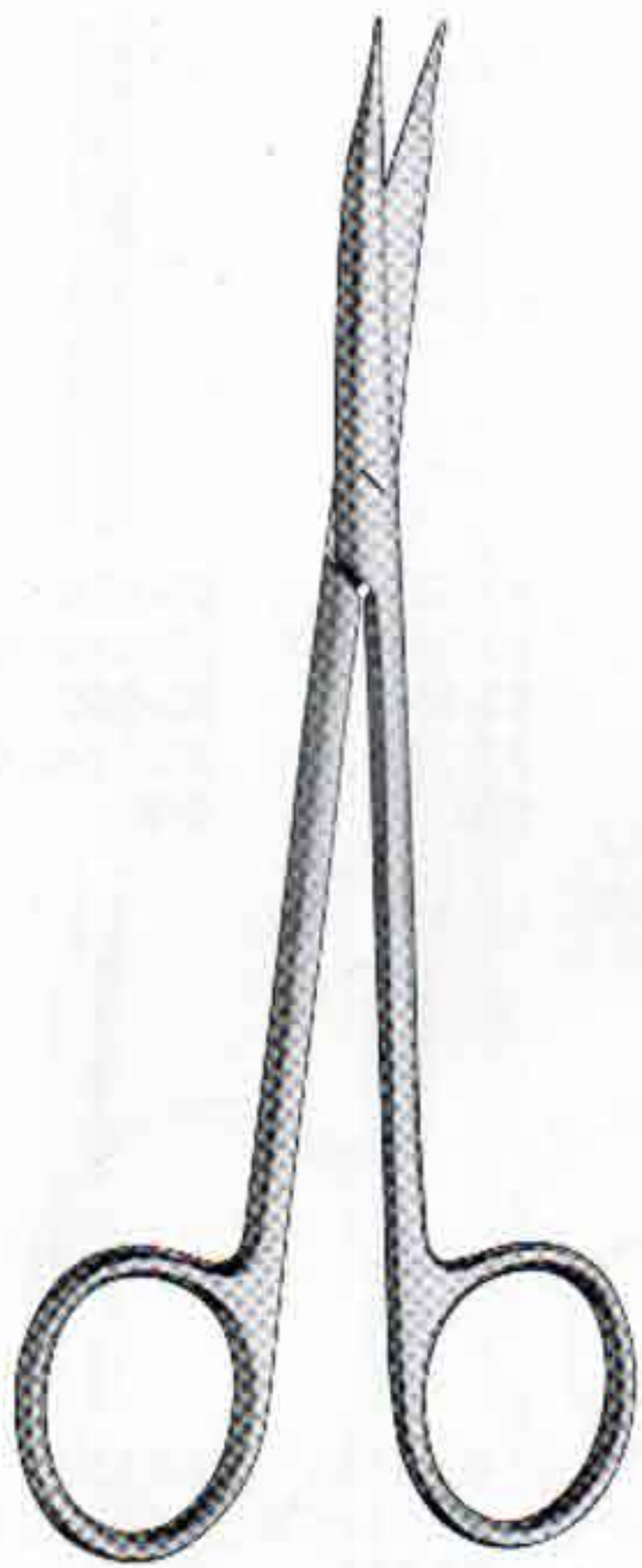

**POTTS-REYNOLDS  
TENOTOMY**  
03-620  
12.0 cm, 4 3/4"  
Curved

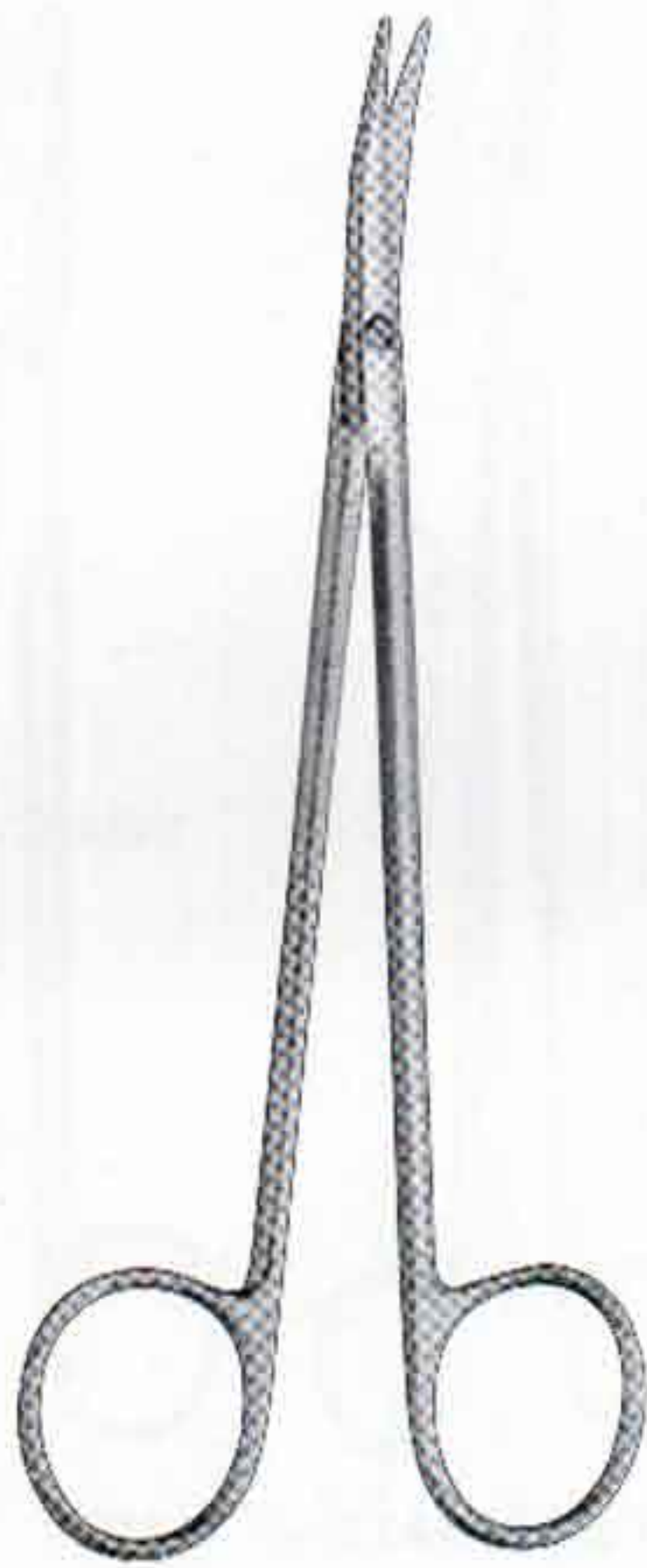

**POTTS TENOTOMY**  
03-630 15.2 cm, 6"  
03-631 17.8 cm, 7"  
03-632 20.3 cm, 8"



**SLAYER**  
03-635  
10 cm

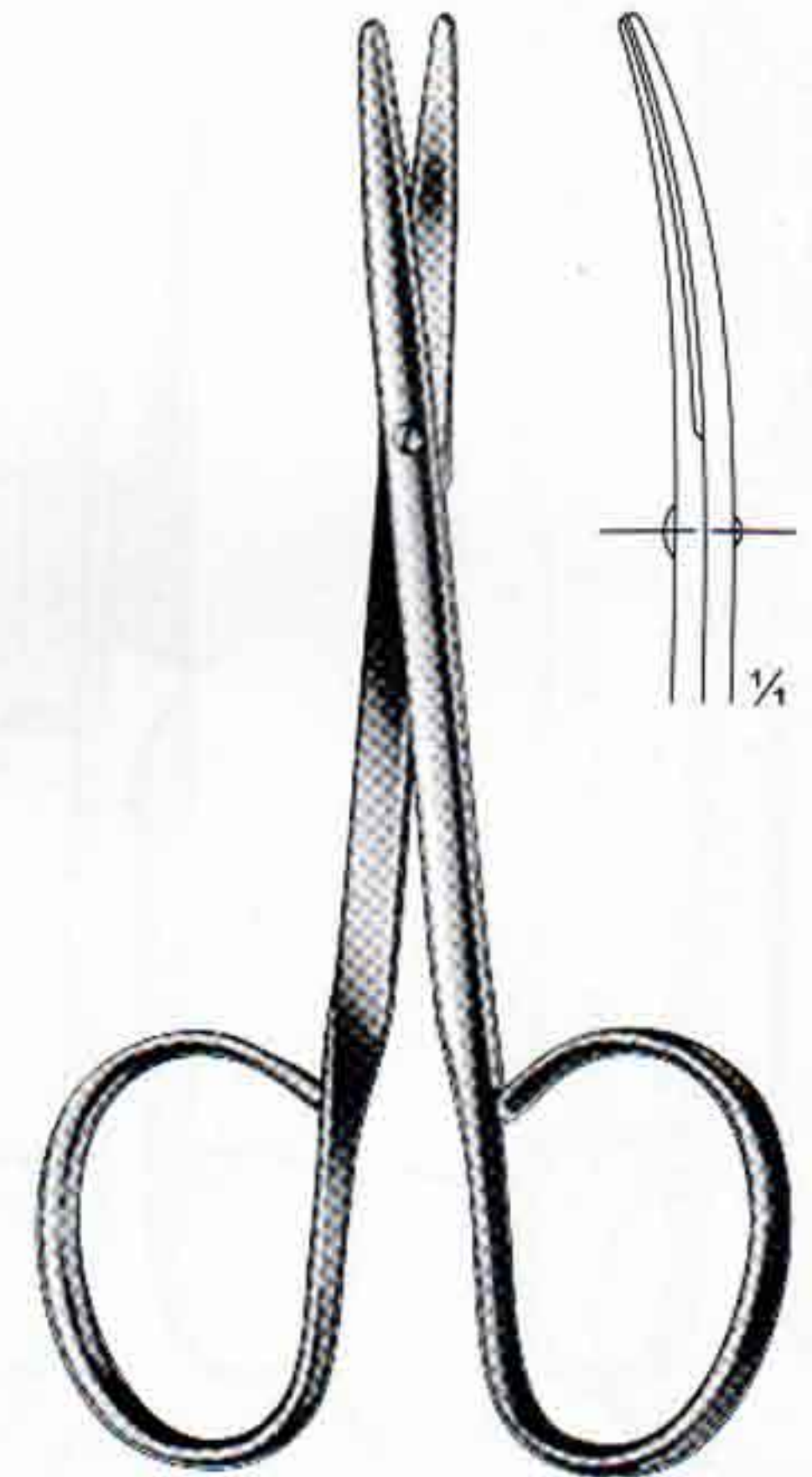

**03-640**  
10.0 cm, 4"  
Straight

**03-641**  
10.0 cm, 4"  
Curved

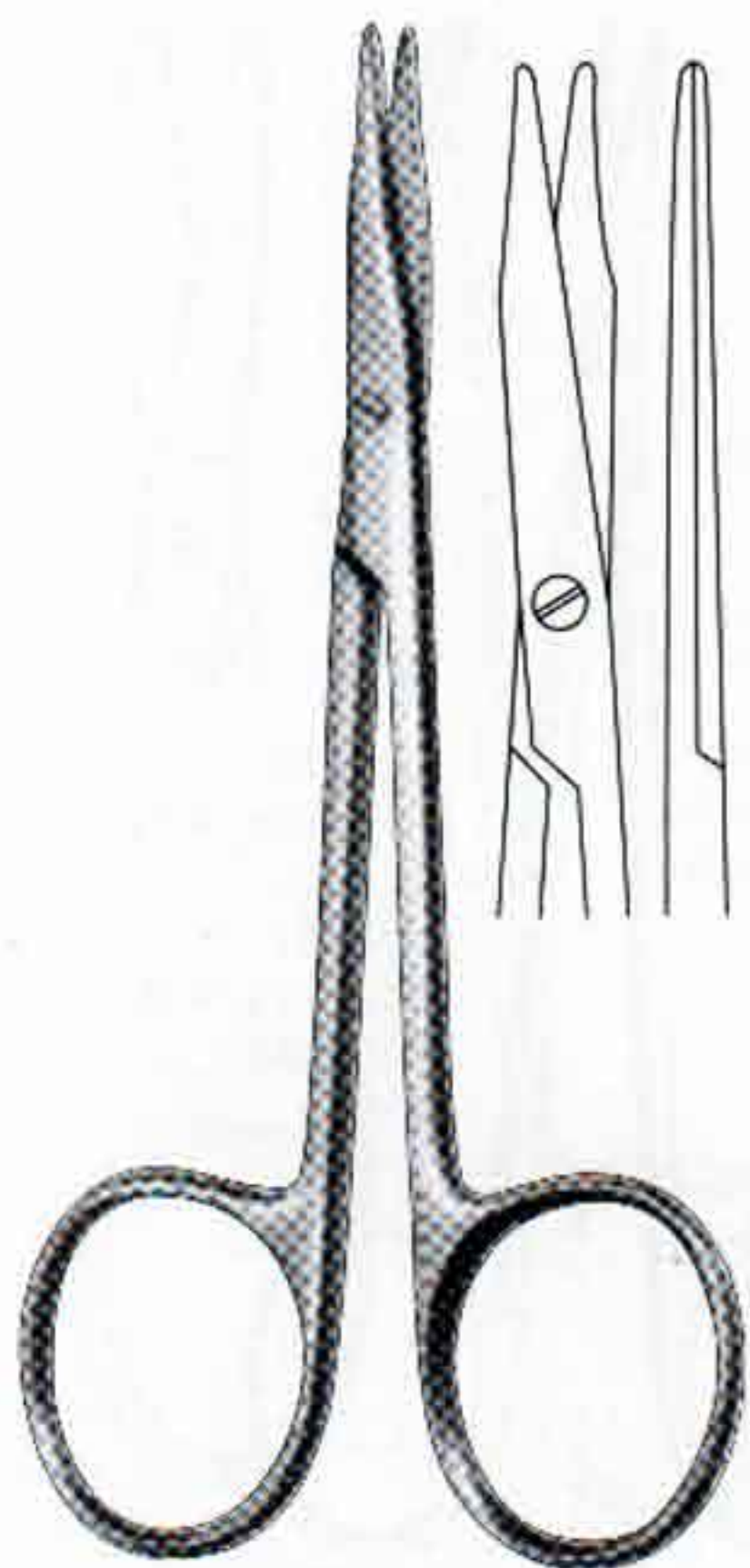

**TENOTOMY-STEVENS**  
03-650 Straight  
03-651 Curved  
11 cm, 4 1/4"

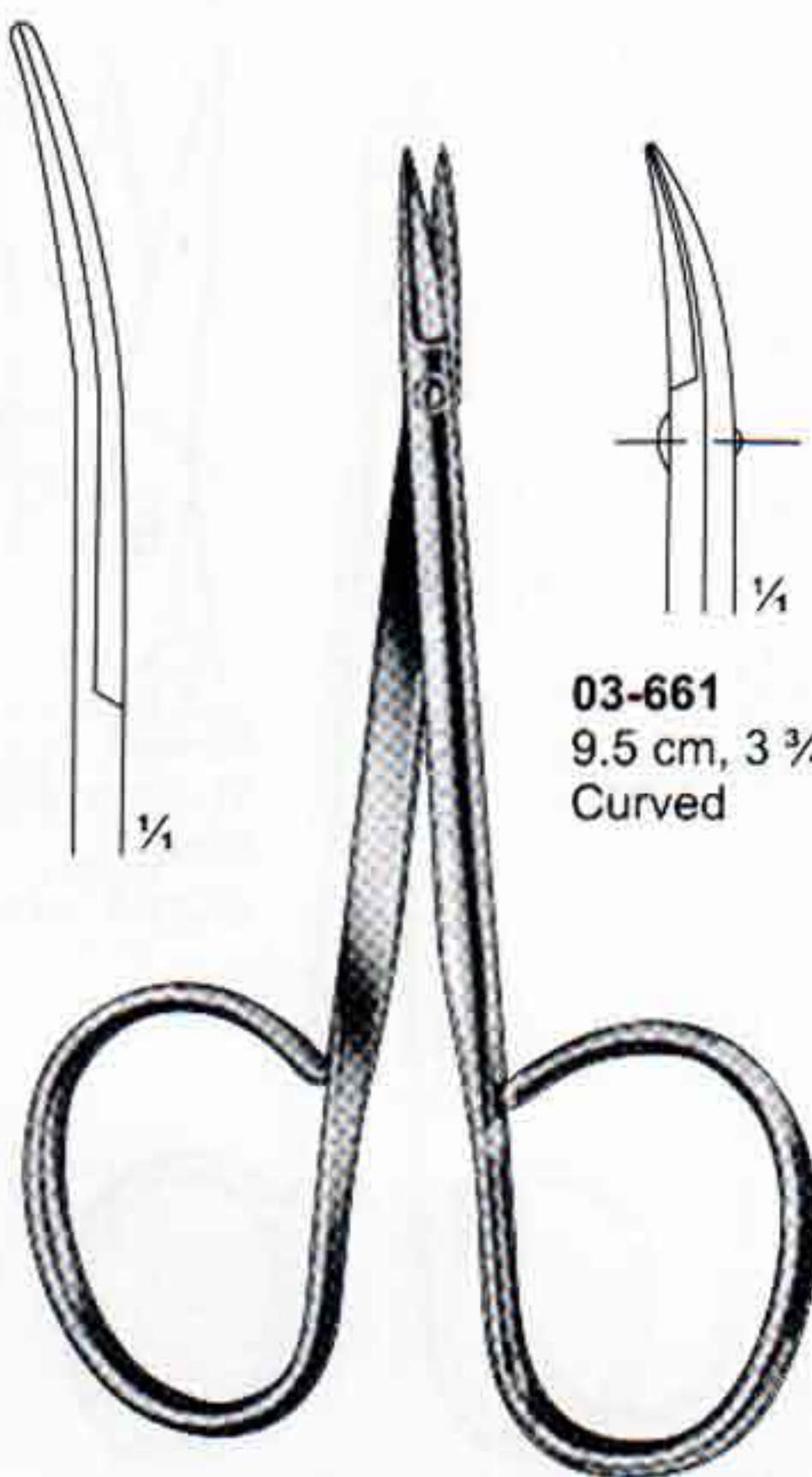

**TENOTOMY**  
03-660  
9.5 cm, 3 3/4"  
Straight

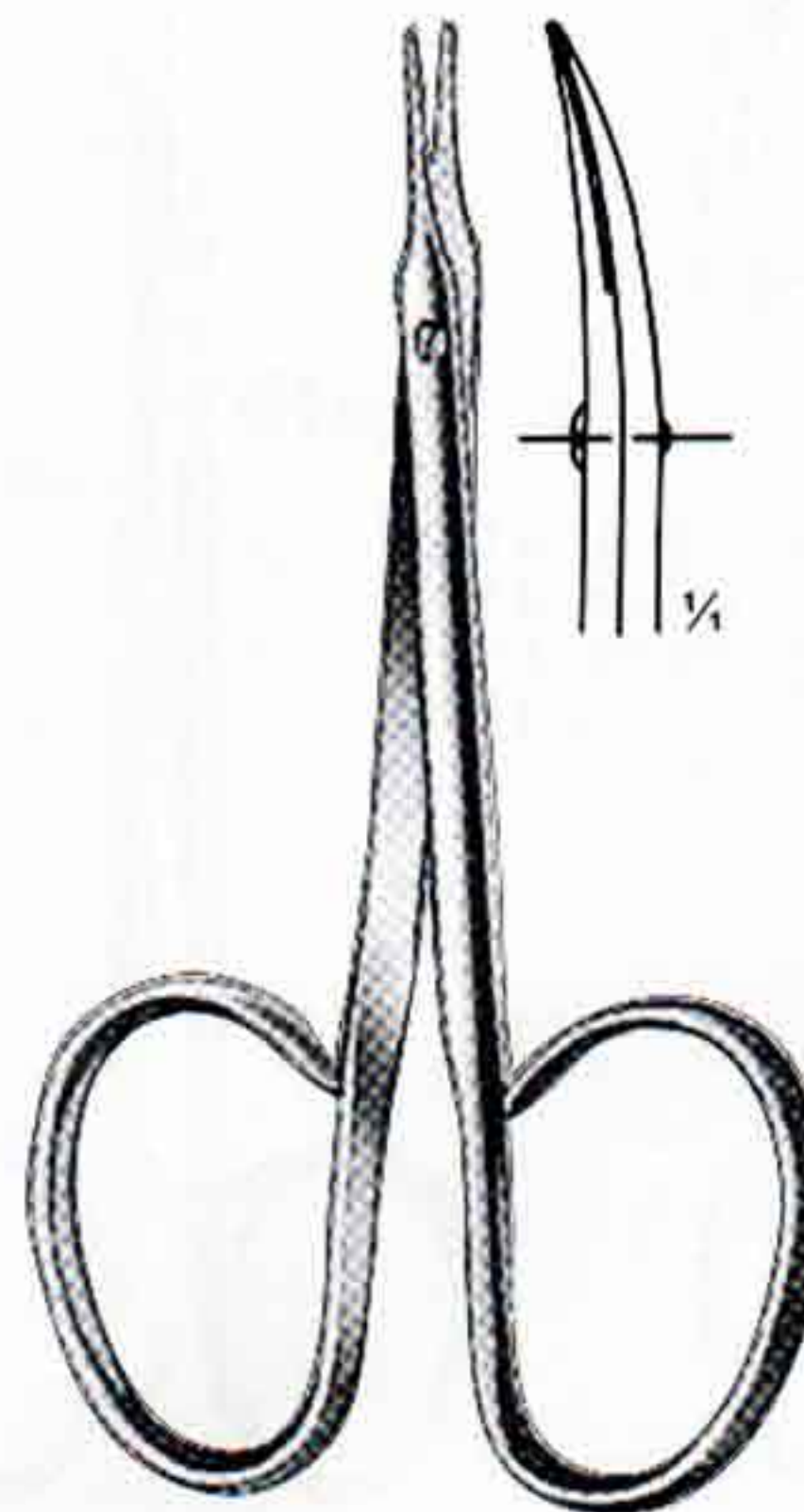

**TENOTOMY**  
03-670  
9.5 cm, 3 3/4"  
Curved-Ribbon  
Handles blunt/blunt

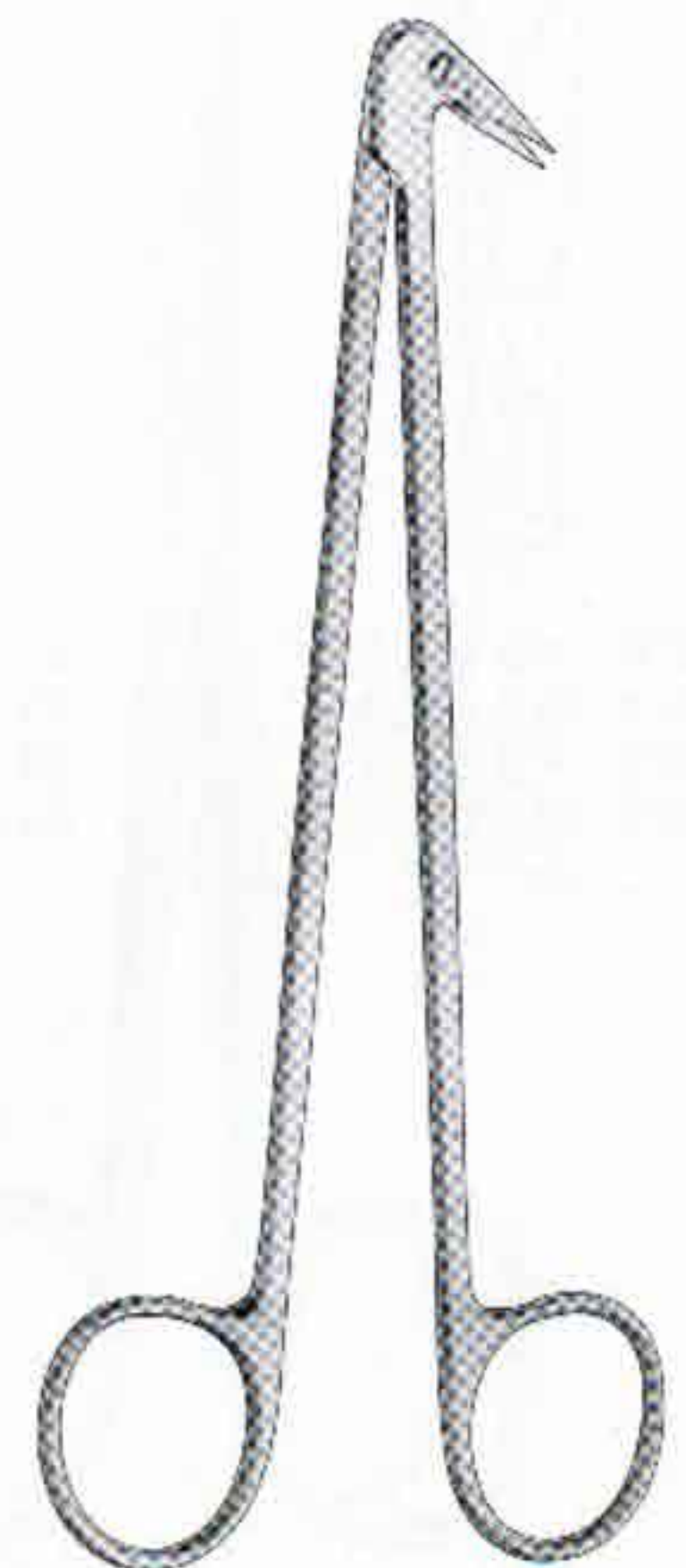

**COOLEY REVERSE  
Cut Scissors**  
03-680  
angled 120°  
17.1 cm, 6 3/4"



# VASCULAR SCISSORS

Gefäßscheren  
Tijeras vasculares

Ciseaux vasculaires  
Forbici vascolari



## POTTS-SMITH

- 03-690 19.1 cm, 7 1/2" angled 25°
- 03-691 13.3 cm, 5 1/4" angled 45°
- 03-692 19.1 cm, 7 1/2" angled 45°
- 03-693 19.1 cm, 7 1/2" angled 60°
- 03-694 19.1 cm, 7 1/2" angled 90°

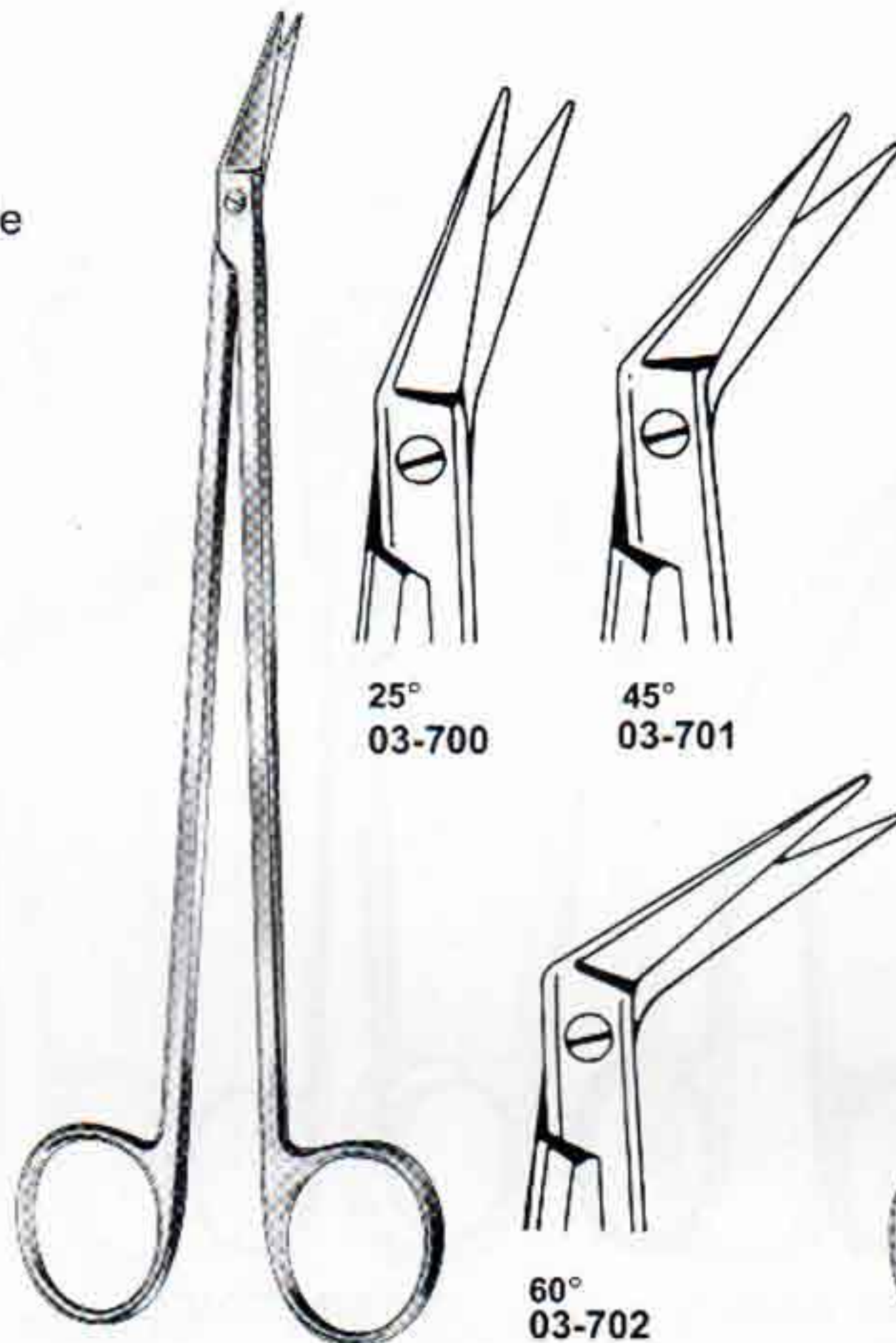

## POTTS-SMITH

19.0 cm, 7 1/2"

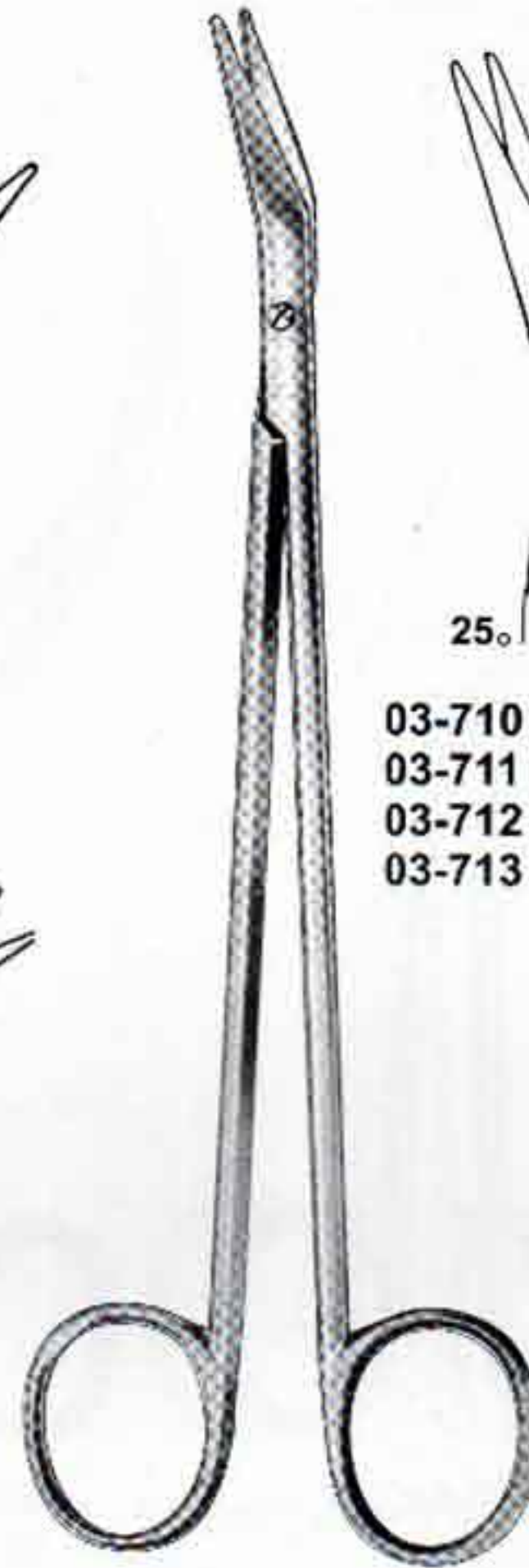
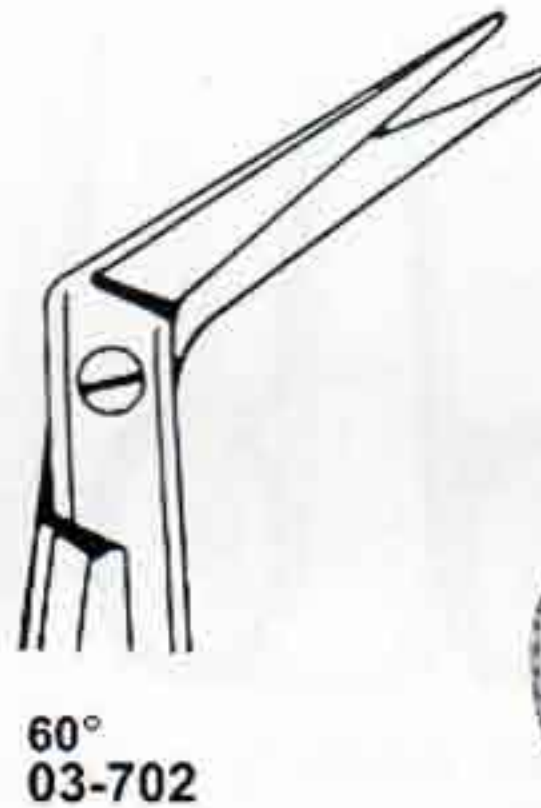

## DE BAKLEY

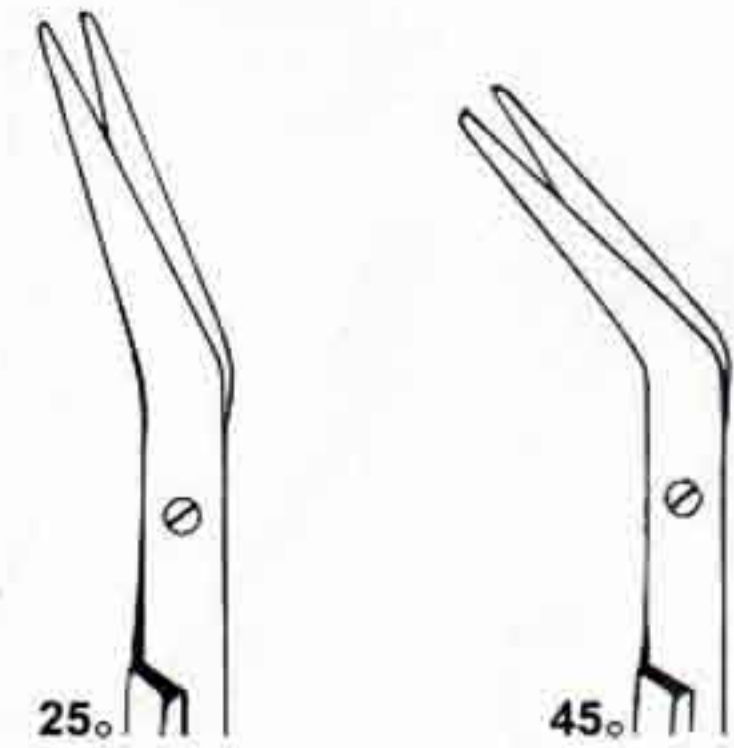

- 03-710 16.0 cm, 6 1/4"
- 03-711 19.0 cm, 7 1/2"
- 03-712 23.0 cm, 9"
- 03-713 28.0 cm, 11"
- 03-714 16.0 cm, 6 1/4"
- 03-715 19.0 cm, 7 1/2"
- 03-716 23.0 cm, 9"
- 03-717 28.0 cm, 11"

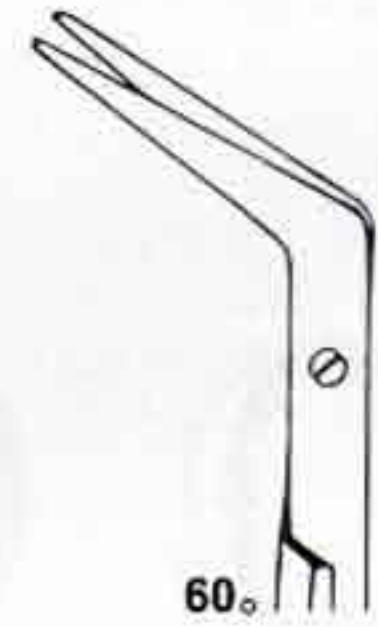

- 03-718 16.0 cm, 6 1/4"
- 03-719 19.0 cm, 7 1/2"
- 03-720 23.0 cm, 9"
- 03-721 28.0 cm, 11"

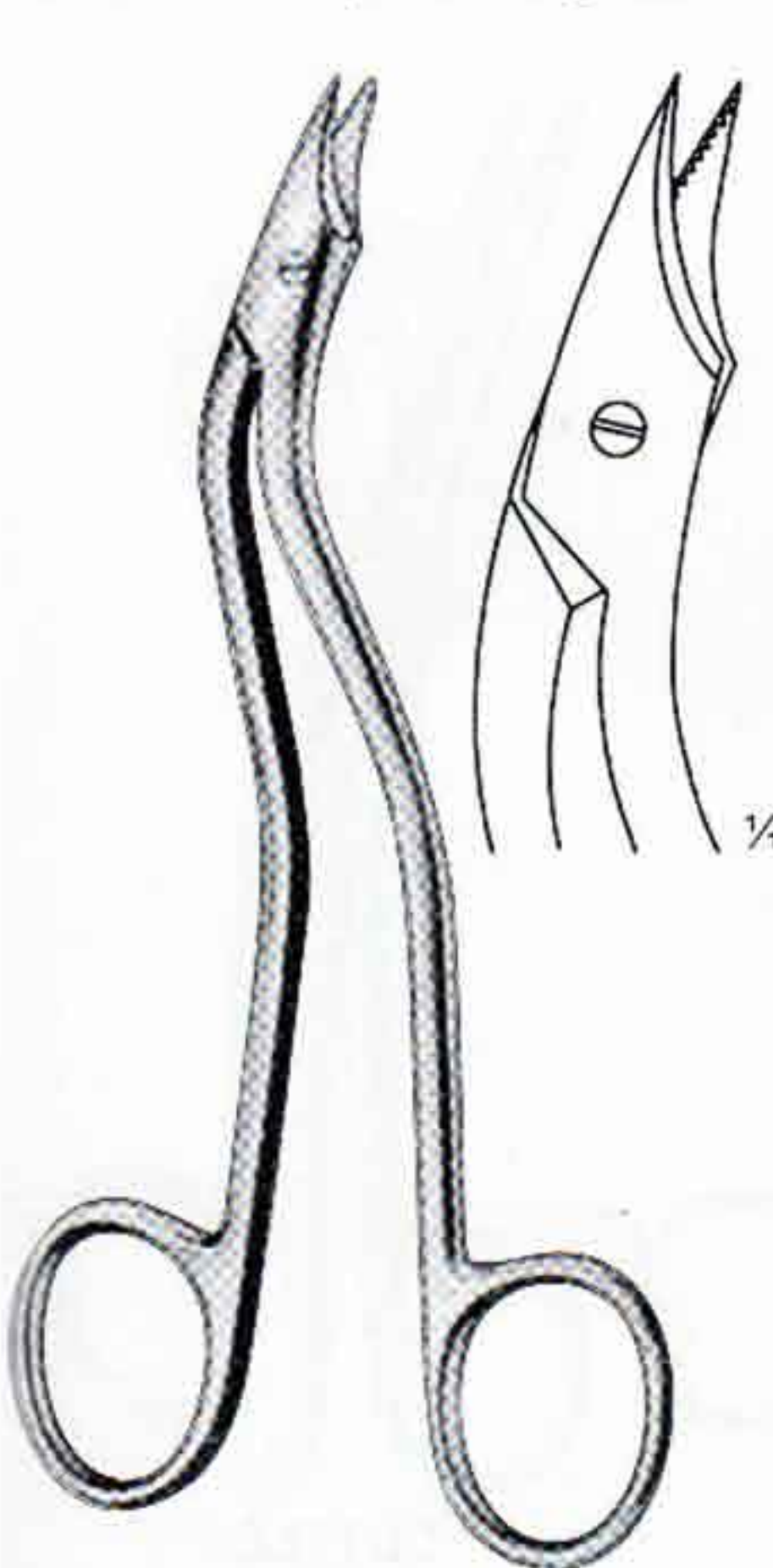

## HEATH

03-730  
15.0 cm, 6"

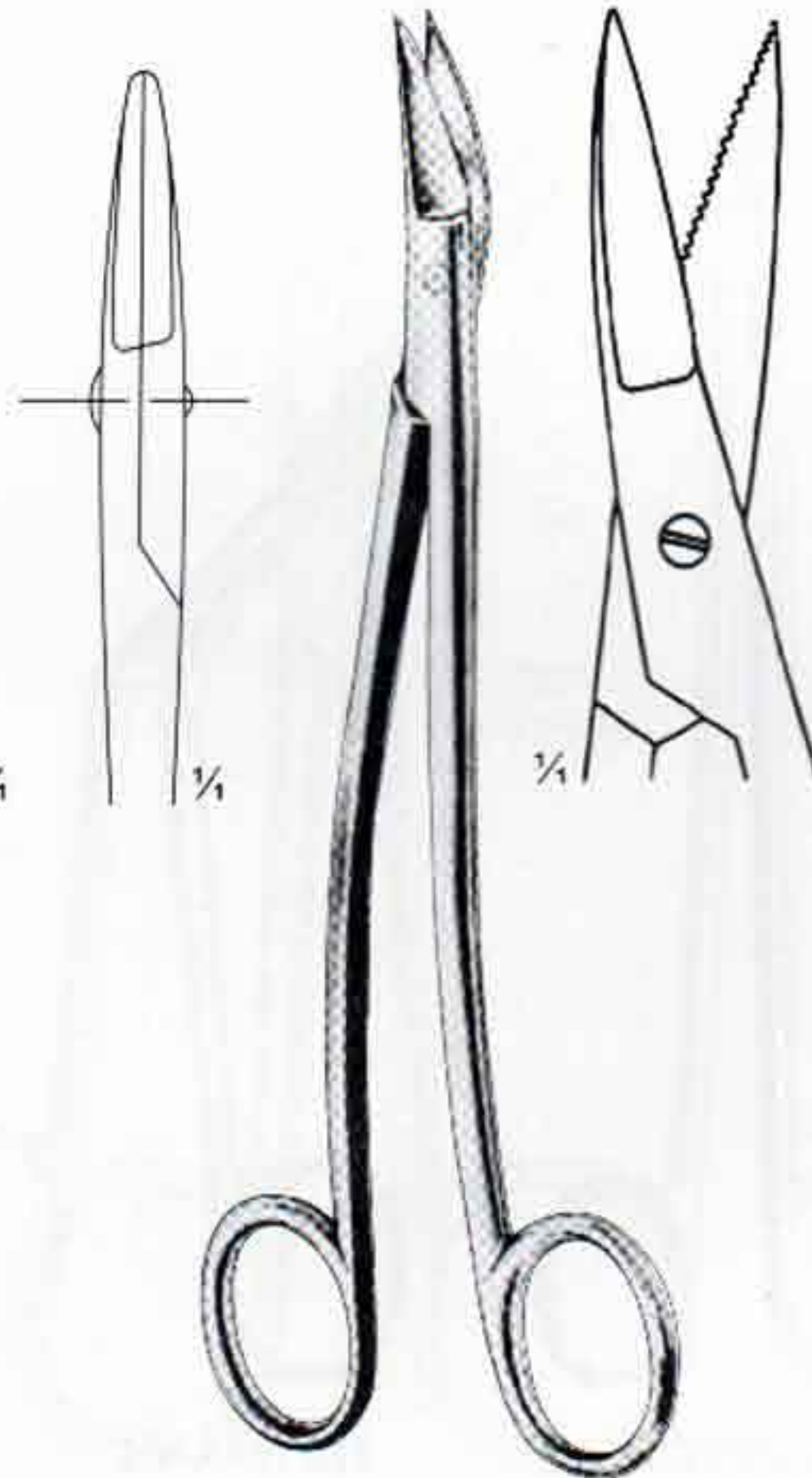

## ENT-DEAN

03-740  
17 cm, 6 3/4"  
Serrated

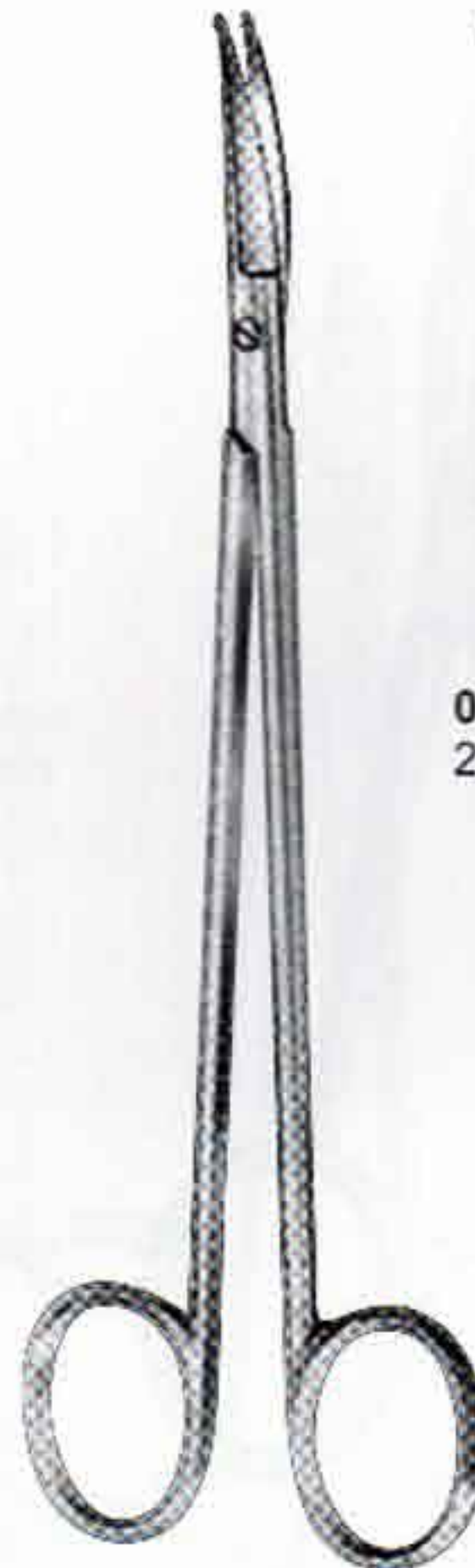

## STRULLY

03-750  
22.0 cm, 8 3/4"

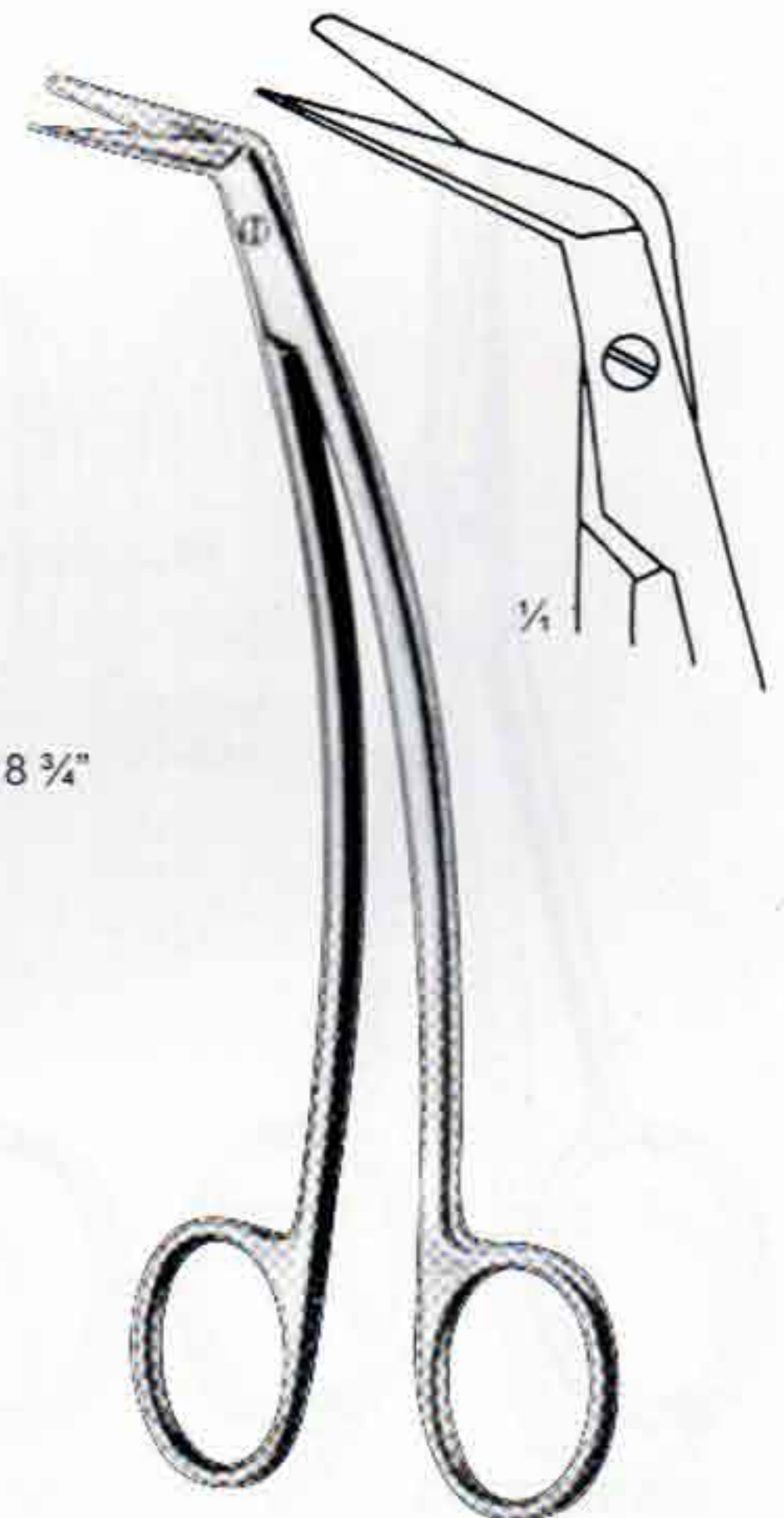

## FAVALORO

03-760  
15.0 cm, 6"



# VASCULAR, ENTEROTOMY & TONSIL SCISSORS

Gefäßscheren, Darmscheren, Tonsillenscheren  
 Tijeras vasculares, Tijeras para intestino, Tijeras para amigdalas

Ciseaux vasculaires, Ciseaux-entérotomes, Ciseaux pour less amygdales  
 Forbici vascolari, Forbici per enterotomia, Forbici per tonsille

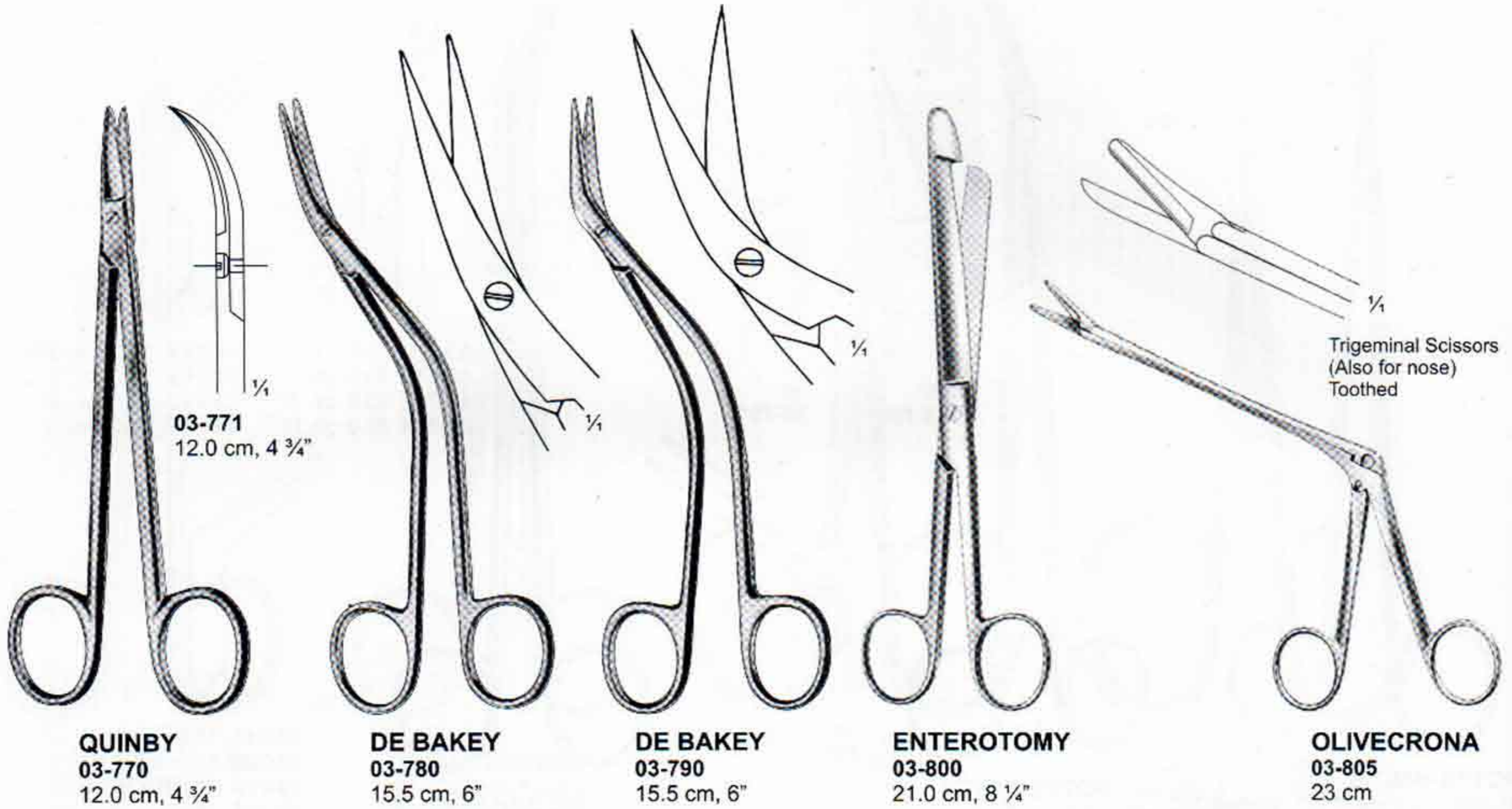



# GUM, STITCH & WIRE CUTTING SCISSORS



Zahnfleischscheren, Fadenschere, Drahtschere  
Tijeras para encias, Tijeras para hilos, Tijeras para alambres

Ciseaux à gencives, Ciseaux à ligatures, Cisailles à fils  
Forbici per gengiva, Forbici per legature, Forbici per filo metallico



**ROUND CUT**  
03-860  
23.5 cm, 9"



**LE GRANGE**  
03-870  
11 cm, 4 1/4"

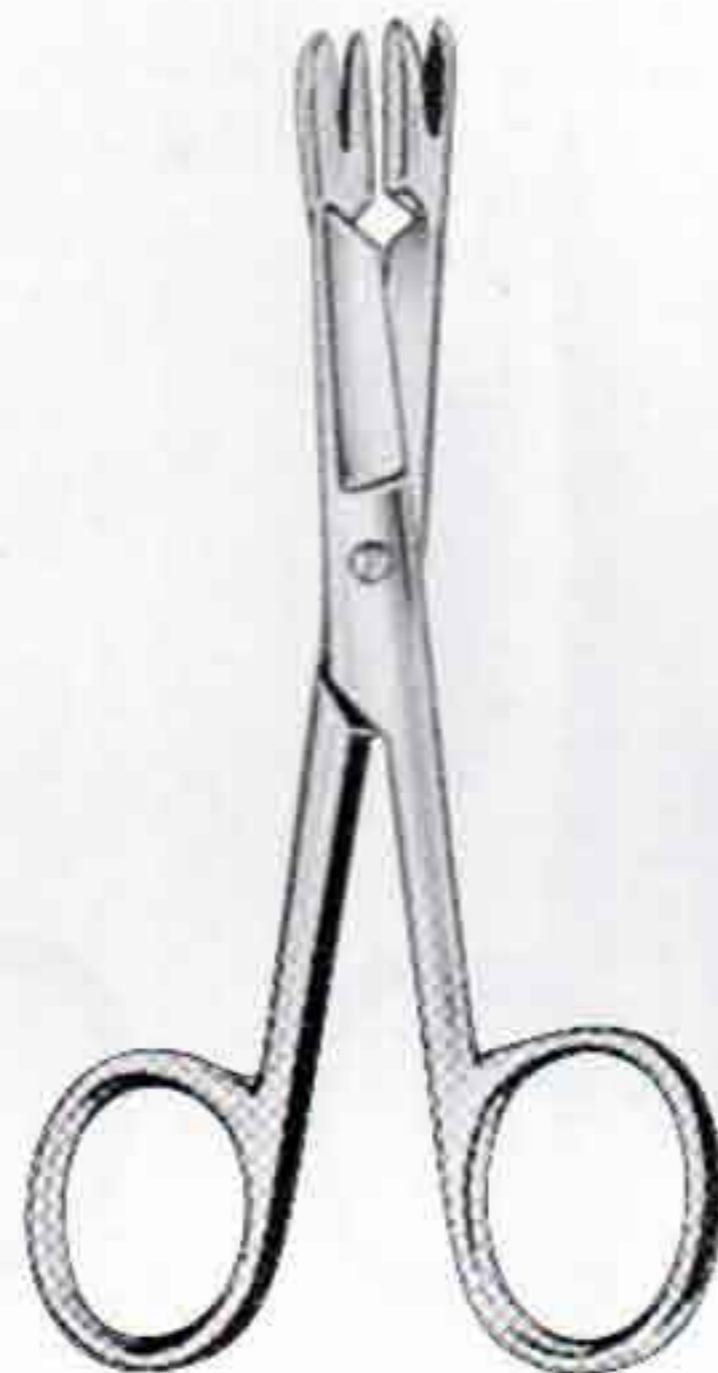

**SCHOEMAKER-LOTH**  
03-880  
12.5 cm, 5"



**SPENCER / DELICATE**  
03-890  
11 cm, 4 1/2"



**LITTAUER**  
03-900  
14 cm, 5 1/2"



**MODIFIED-USA**  
03-910  
10 cm, 4"

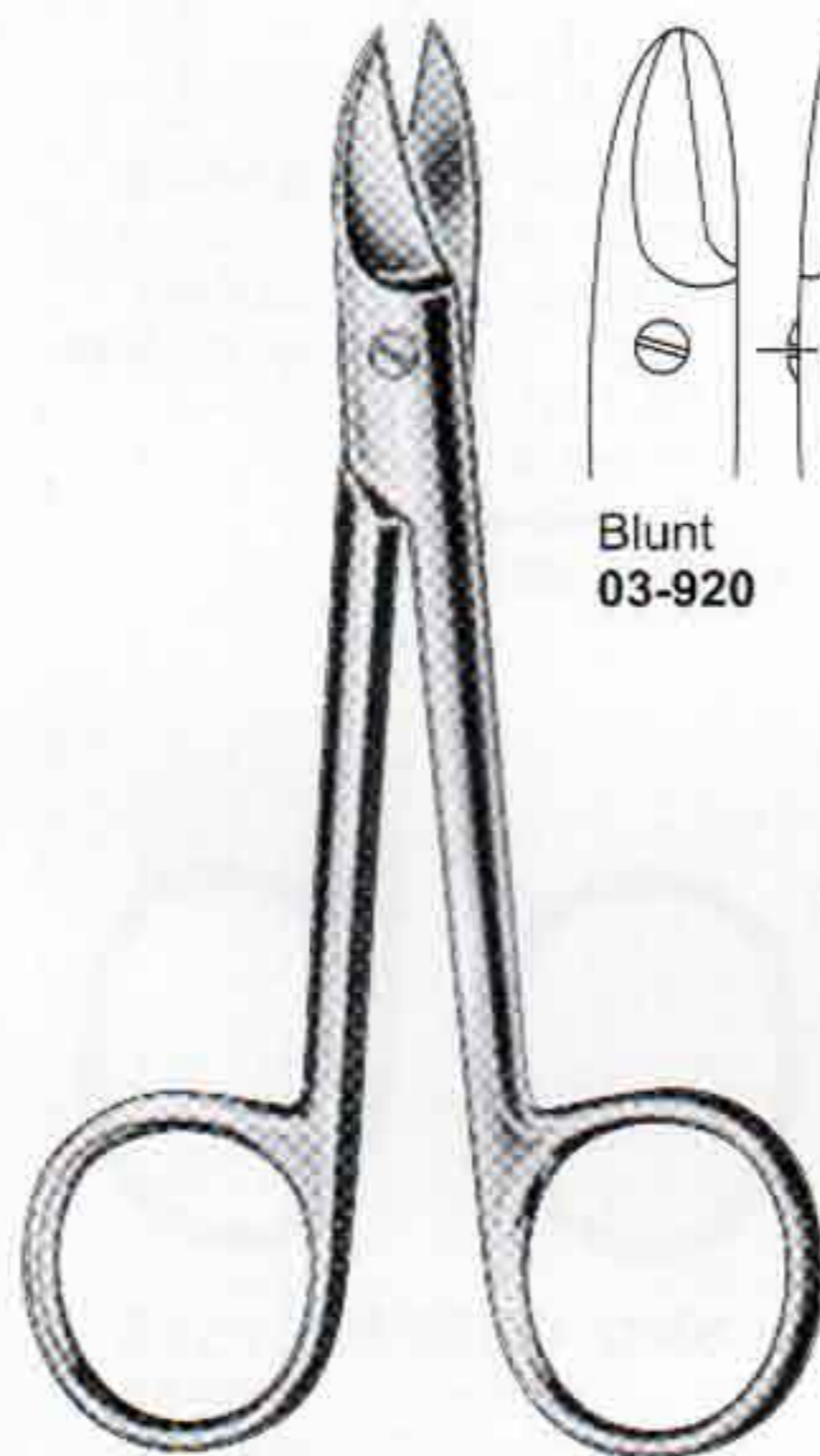

**BEEBEE**  
10.5 cm, 4"  
Straight

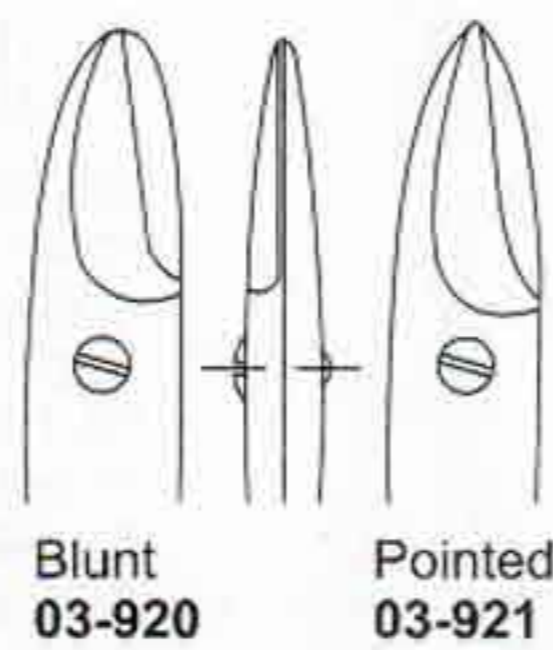

Blunt  
03-920

Pointed  
03-921

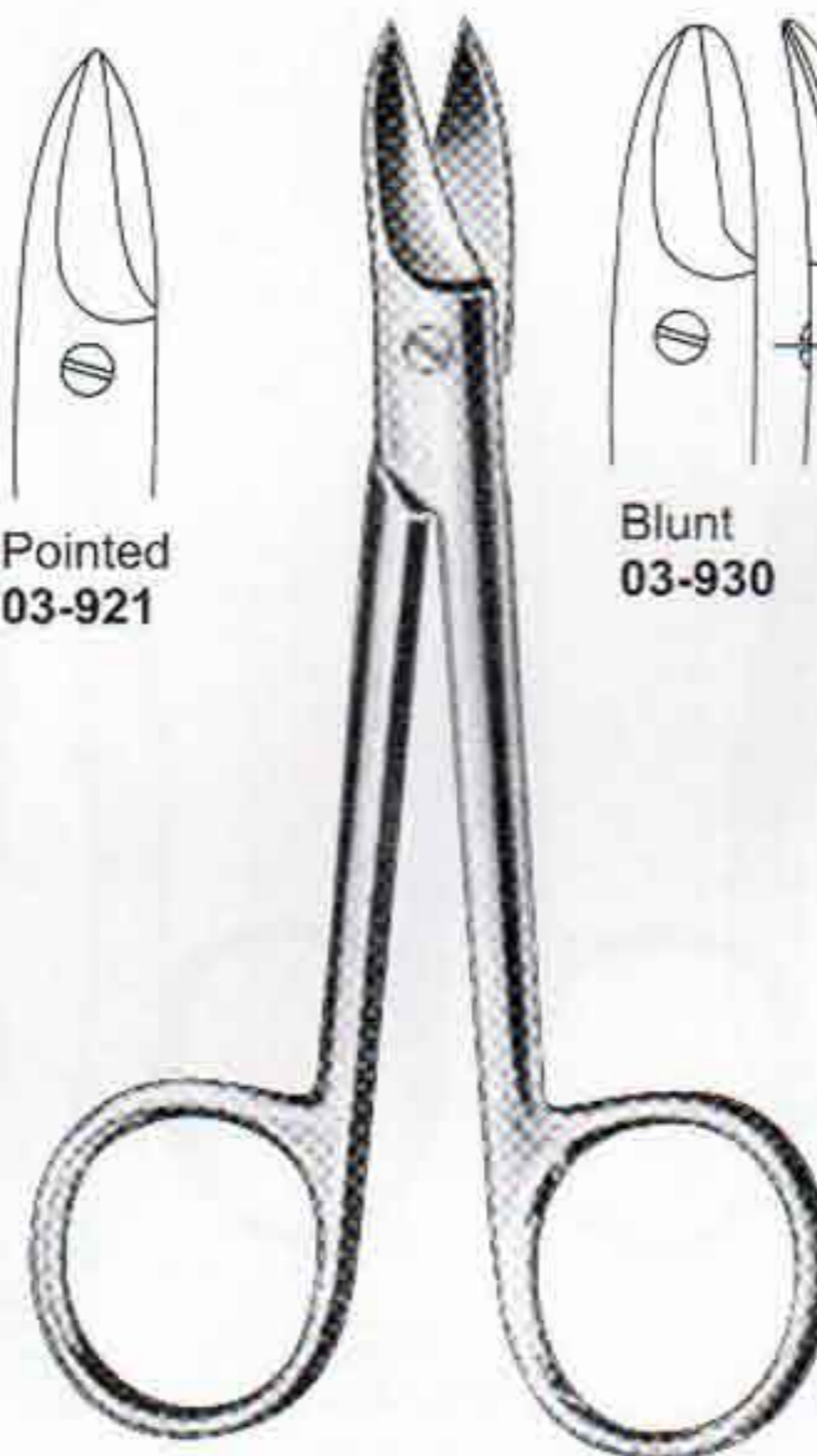

**BEEBEE**  
10.5 cm, 4"  
Curved

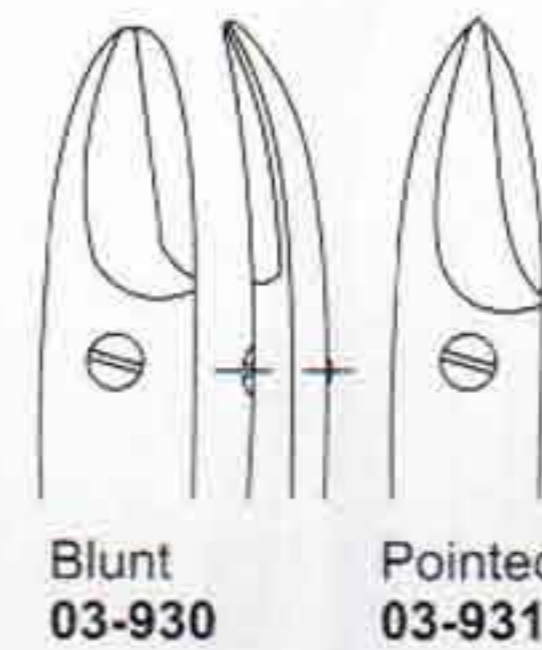

Blunt  
03-930

Pointed  
03-931

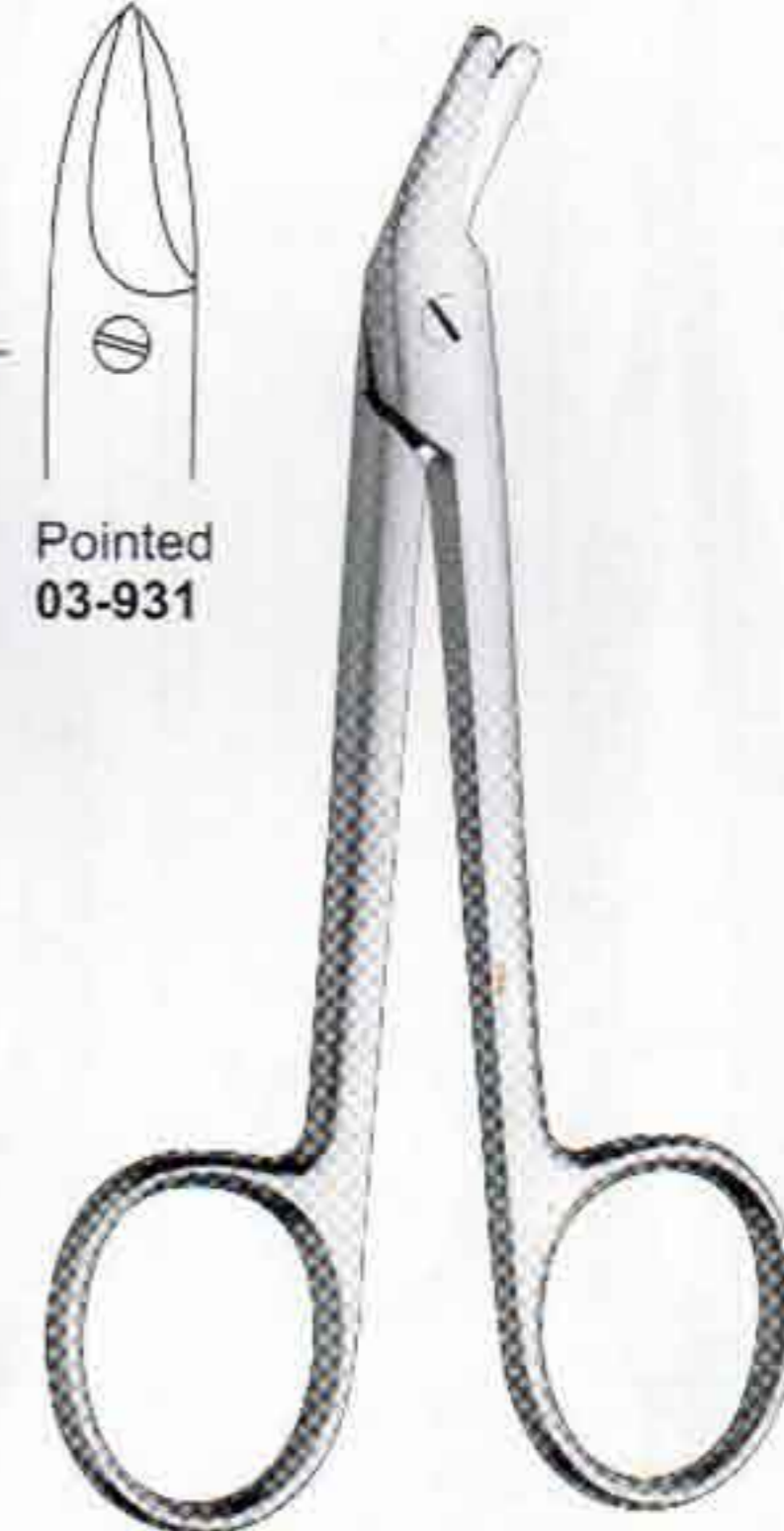

**UNIVERSAL**  
03-940  
11.5 cm, 4 1/2"



# MICRO SCISSORS

Mikroscheren  
Micro scissors

Micro-Ciseaux  
Micro-Forbici



**CASTROVIEJO**  
9.0 cm, 3 1/2"



**03-950**  
B/B

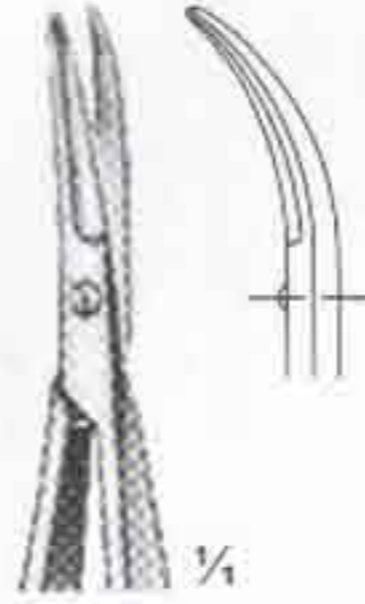

**03-951**  
B/B



**03-952**  
B/S



**03-953**  
S/S

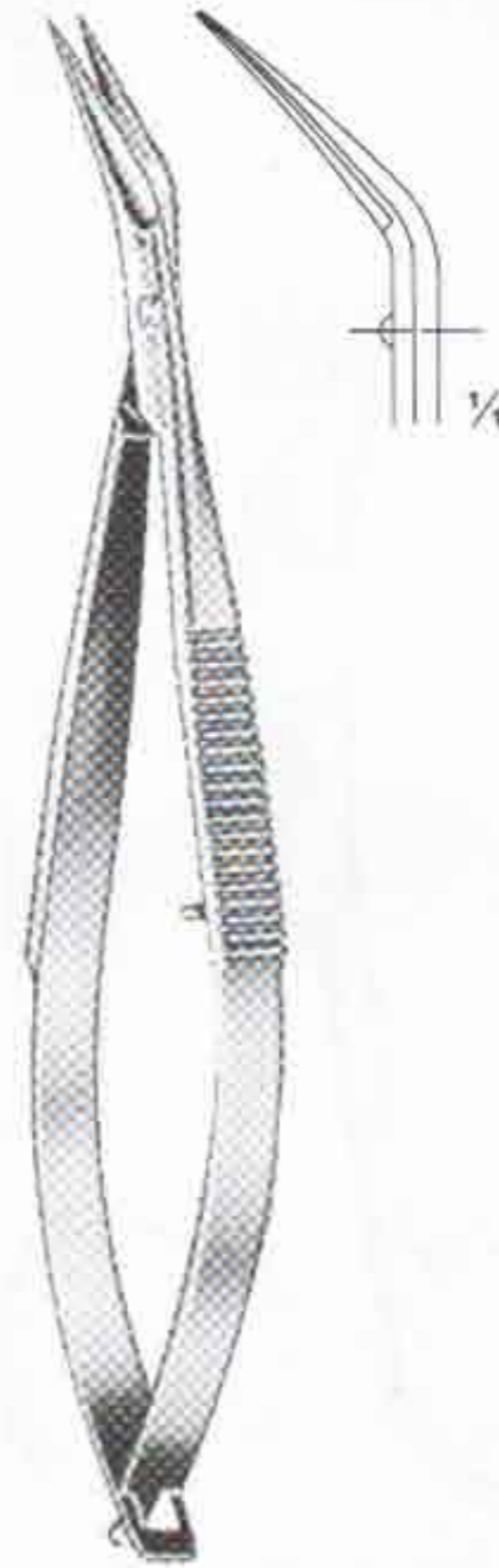

**NOYES**  
**03-960**  
12 cm, 4 3/4"



**NOYES**  
**A 03-970**  
**B 03-971**  
**C 03-972**  
12 cm, 4 3/4"

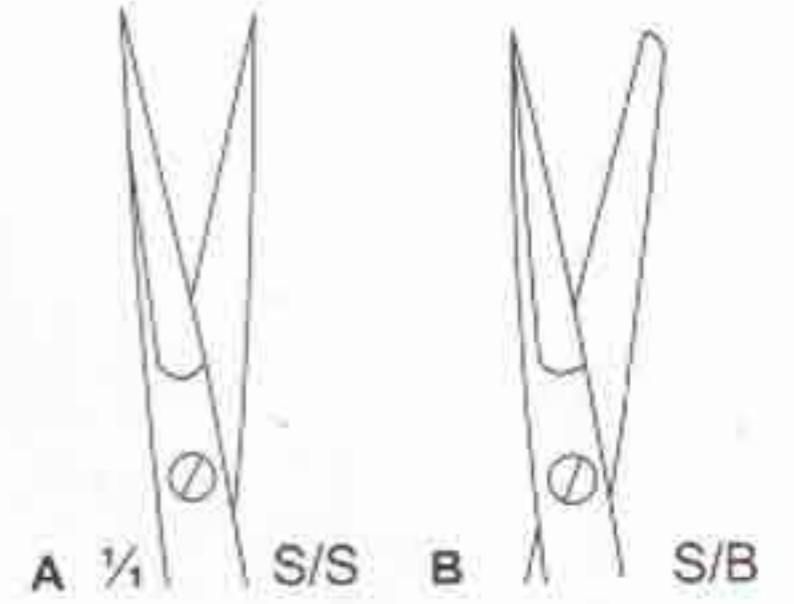

**WESTCOTT**  
**03-980**  
11.5 cm, 4 1/2"



**WESTCOTT**  
**03-990**  
11.5 cm, 4 1/2"



**WESTCOTT**



**03-1000**  
11 cm, 4 1/4"  
Curved  
Sharp/Sharp  
**03-1001**  
11 cm, 4 1/4"  
Curved-Micro  
Sharp/Sharp



**03-1002**  
11 cm, 4 1/4"  
Curved  
Blunt/Blunt

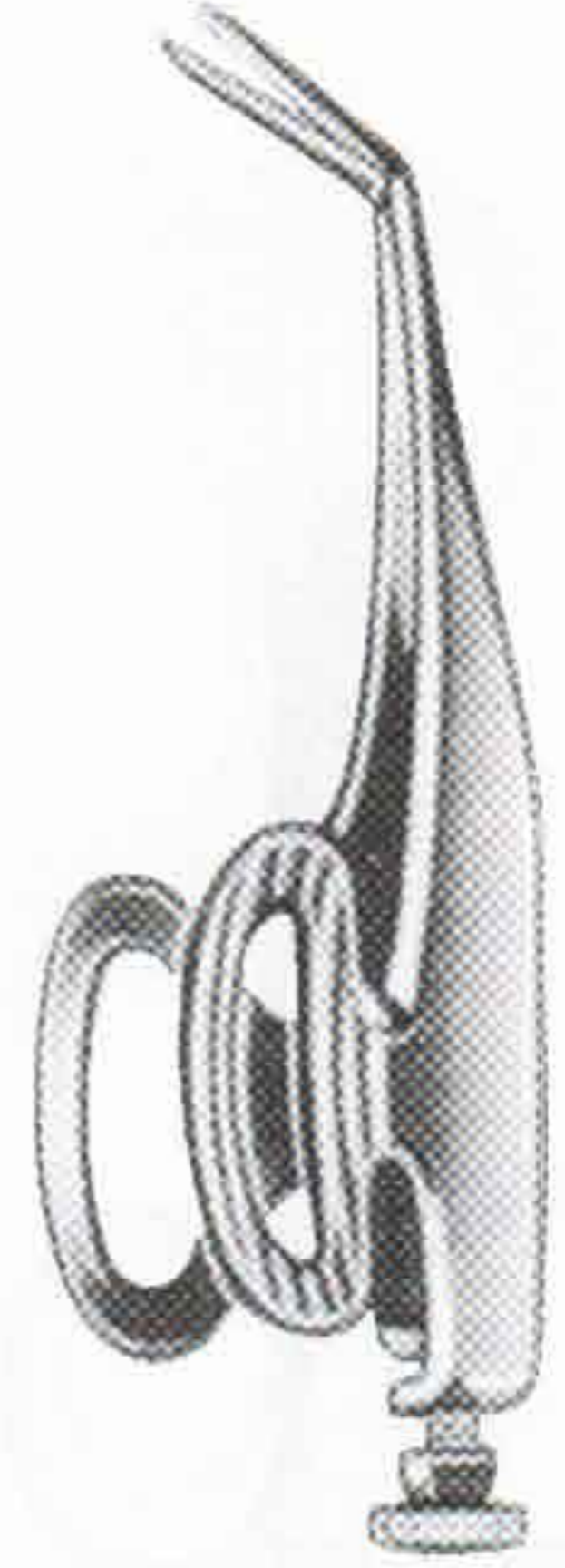

**BARRAQUER**  
**03-1010**  
**03-1011**  
**03-1012**  
5.5 cm, 2 1/4"



# SUPER CUT SCISSORS

scheren  
Tijeras

Ciseaux  
Forbici



**STANDARD**  
03-1020  
14 cm, 5 1/2"  
Straight

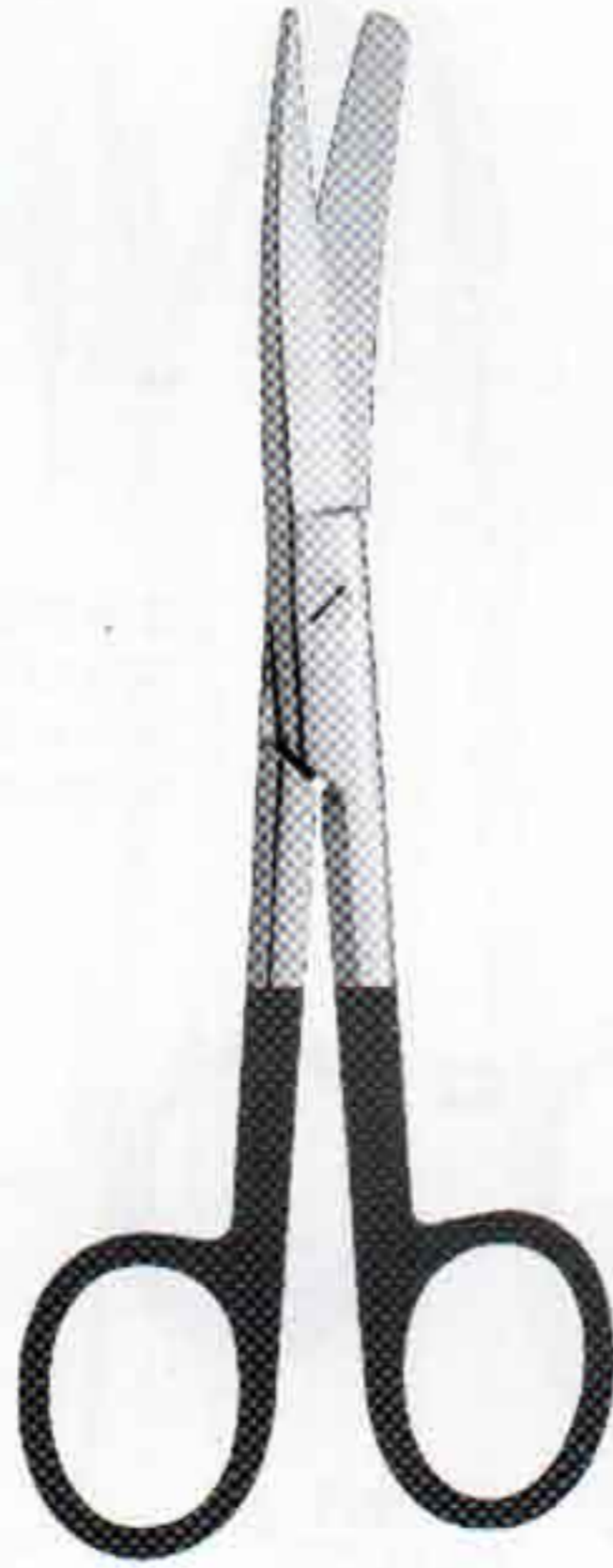

**STANDARD**  
03-1030  
14 cm, 5 1/2"  
Curved



**MAYO**  
03-1040 14 cm, 5 1/2"  
03-1041 15 cm, 6"  
03-1042 18 cm, 7"  
03-1043 20 cm, 8"  
03-1044 23 cm, 9"



**MAYO**  
03-1050  
23 cm, 9"  
Curved



**MAYO**  
03-1060  
23 cm, 9"  
Straight

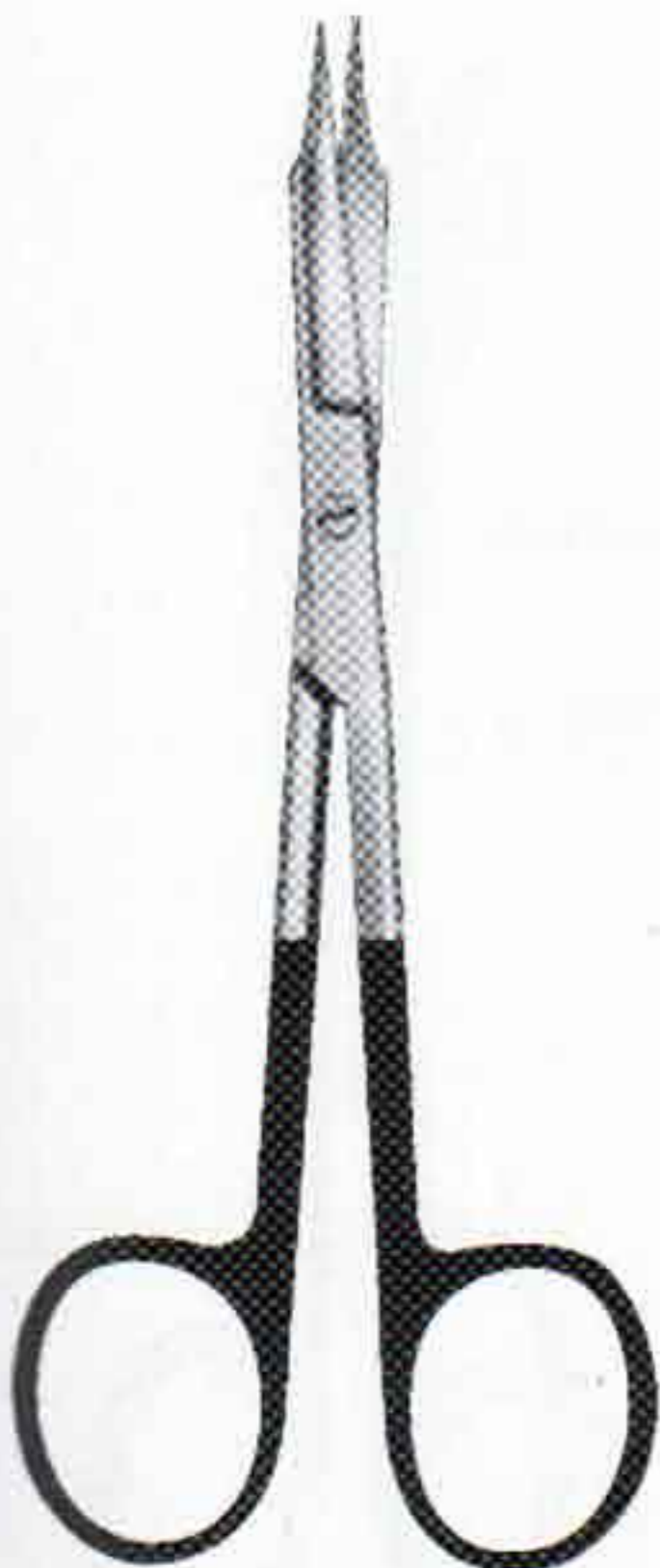

**GOLDMAN-FOX**  
03-1070 Straight  
03-1071 Curved  
9.0 cm, 3 1/2"

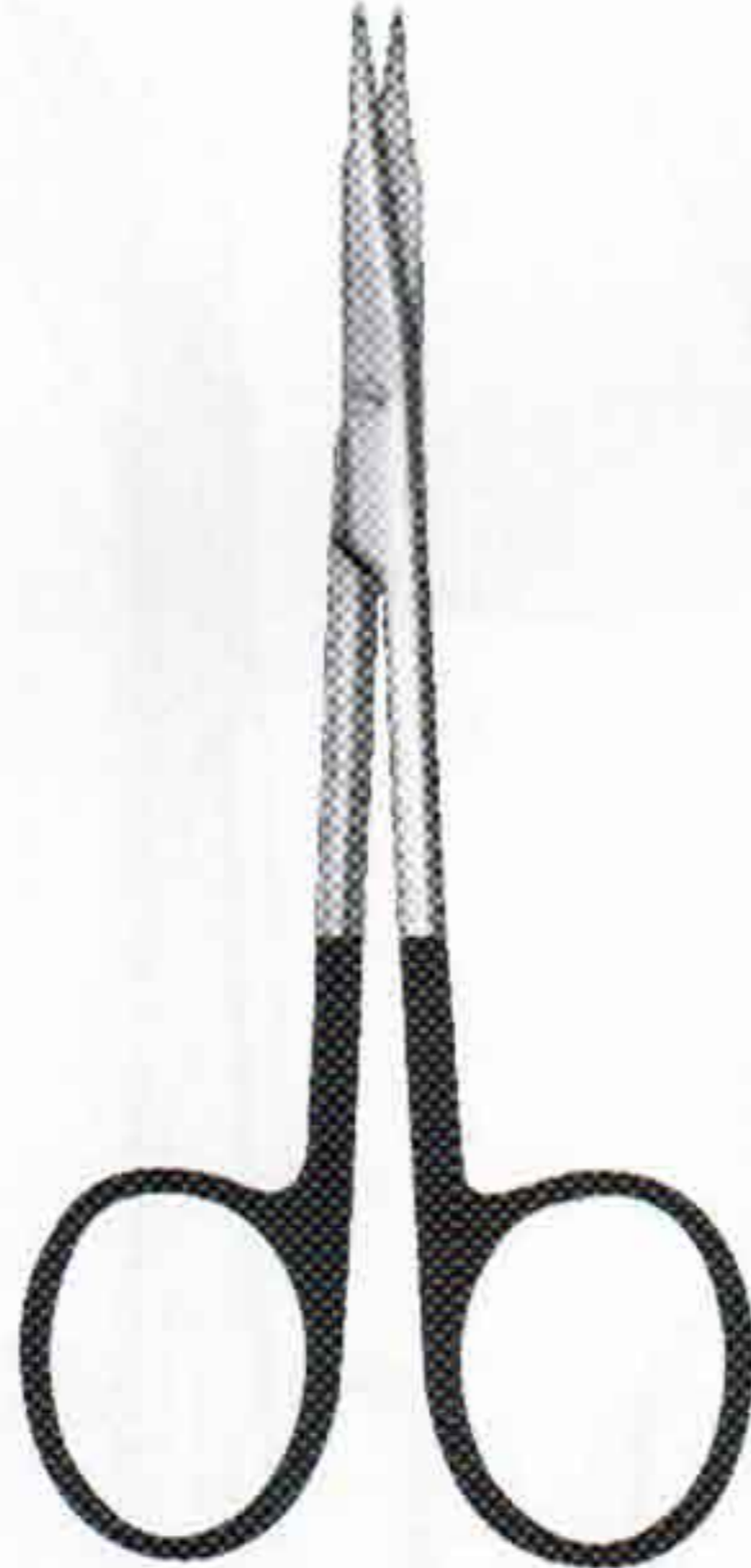

**STEVENS TENOTOMY**  
03-1080 Straight  
03-1081 Curved  
9.0 cm, 3 1/2"

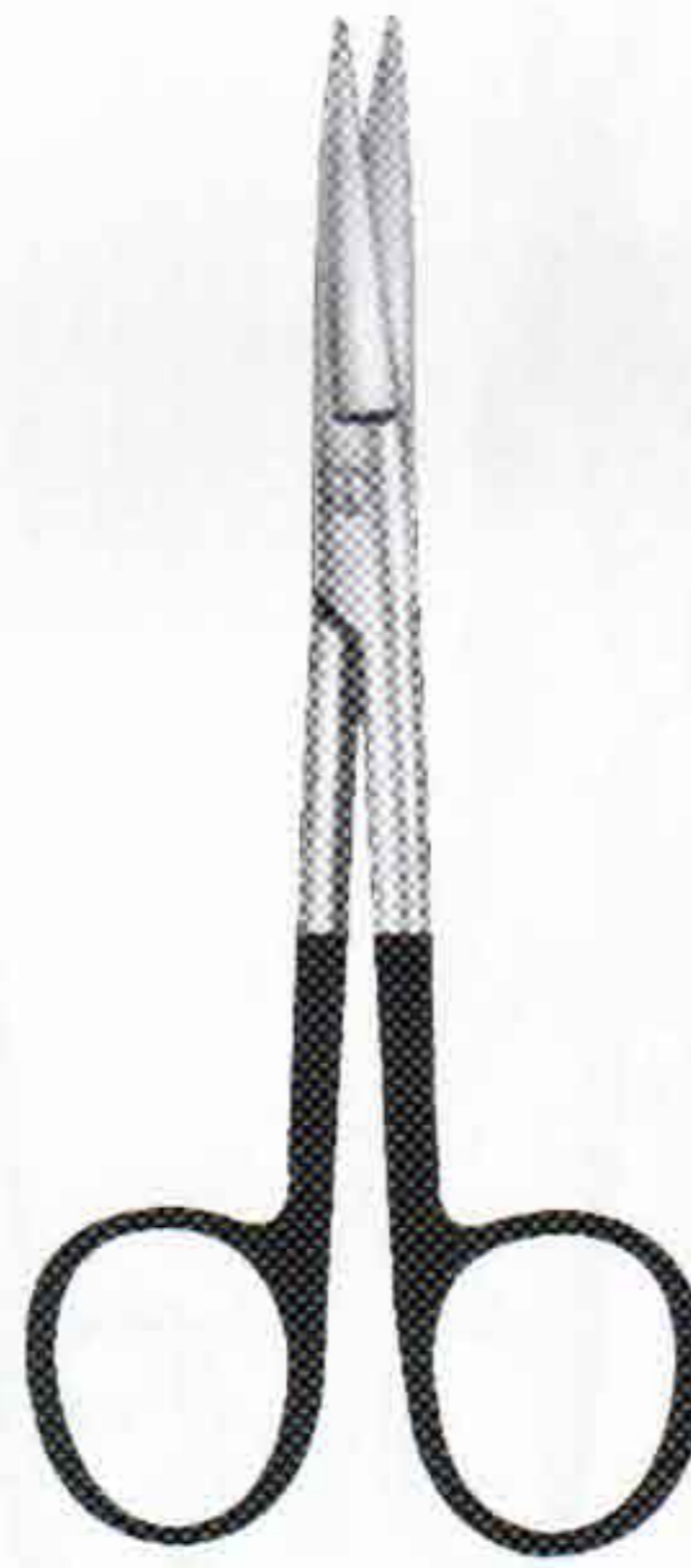

**IRIS**  
03-1090  
9.0 cm, 3 1/2"  
03-1091  
11.4 cm, 4 1/2"  
Straight



**IRIS**  
Angular  
03-1100  
11.4 cm, 4 1/2"



# PLASTER SCISSORS

Gipsschere  
Tijera para yeso

Ciseaux pour plâtre  
Forbici per gesso



**UNIVERSAL** (Colour Available)  
03-1110 14.5 cm, 5 ¾"  
143 C/290 F Autoclavable  
03-1111 15 cm, 6"  
143 C/290 F Autoclavable  
03-1112 16 cm, 6 ¼"  
143 C/290 F Autoclavable  
03-1113 18 cm, 7"  
143 C/290 F Autoclavable

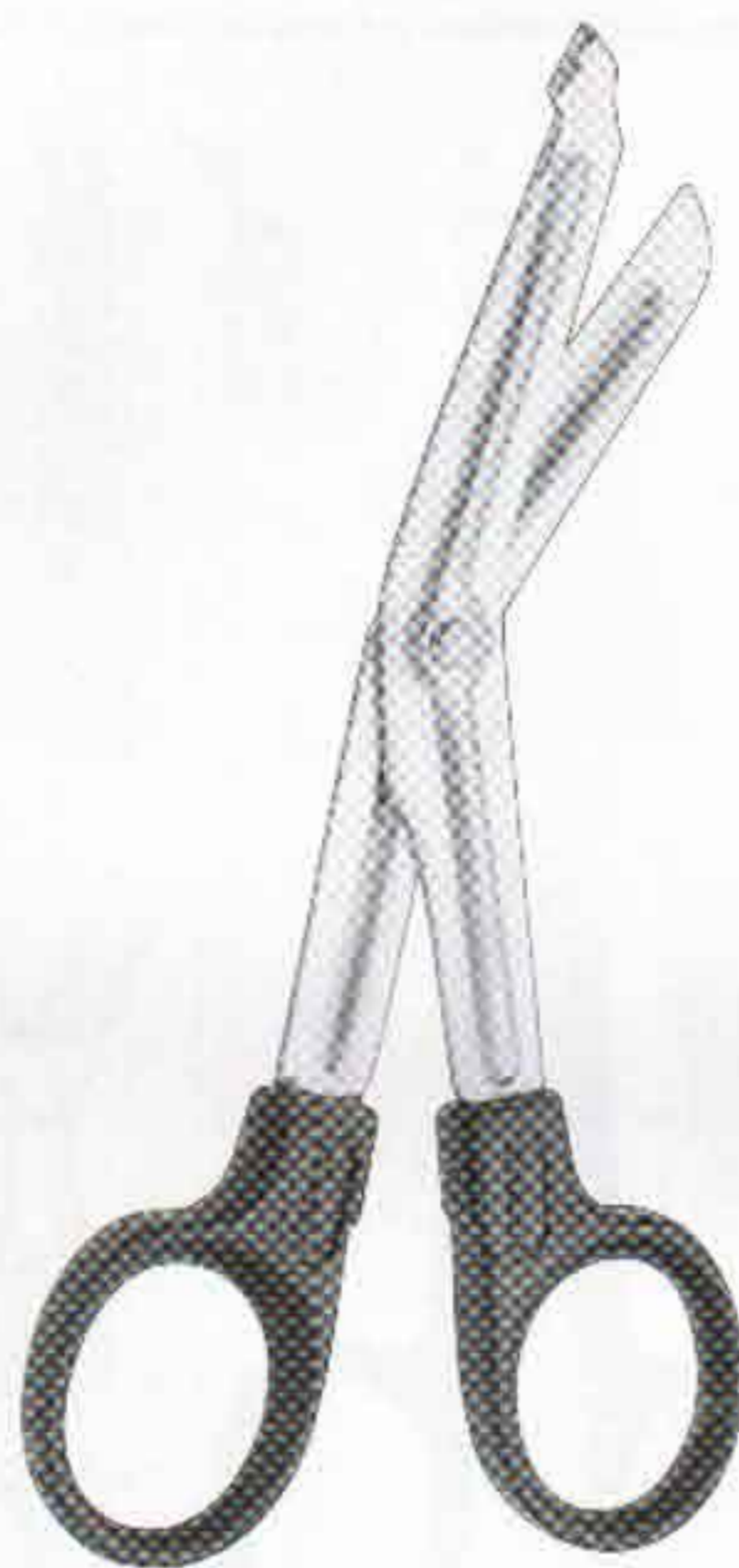

**UNIVERSAL BANDAGE**  
03-1120  
12 cm, 5"



**BRUNS**  
03-1131  
24 cm, 9 ½"  
serrated

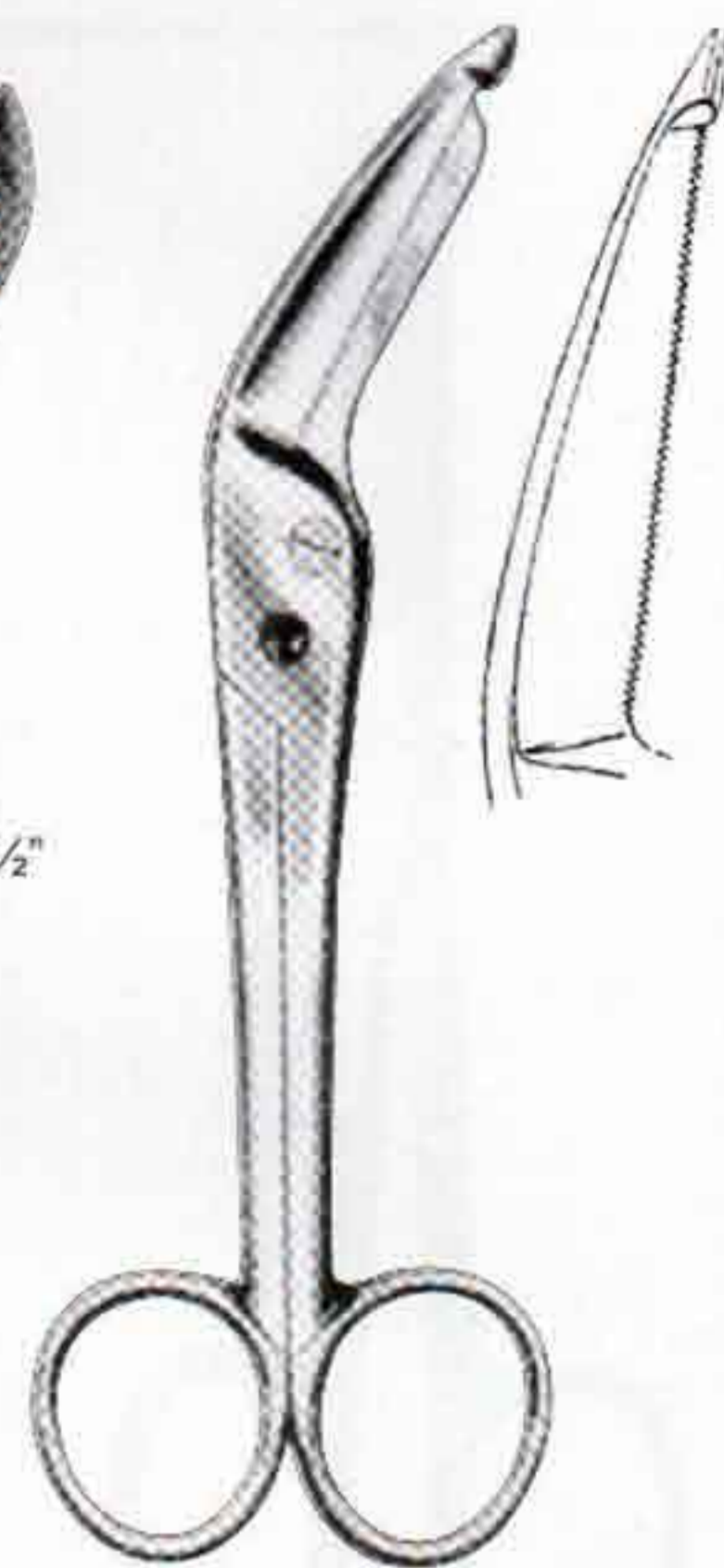

**LISTER**  
03-1140  
Exentric  
19 cm, 7 ½"

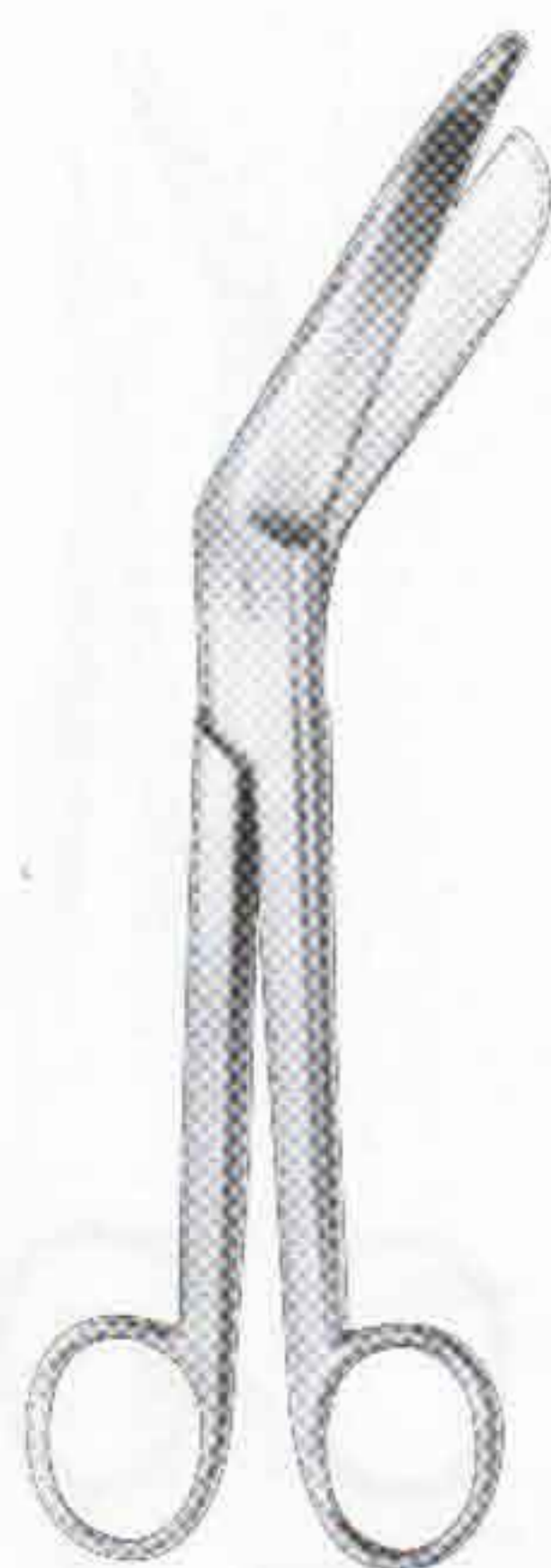

**BERGMANN**  
03-1150  
23 cm, 9"

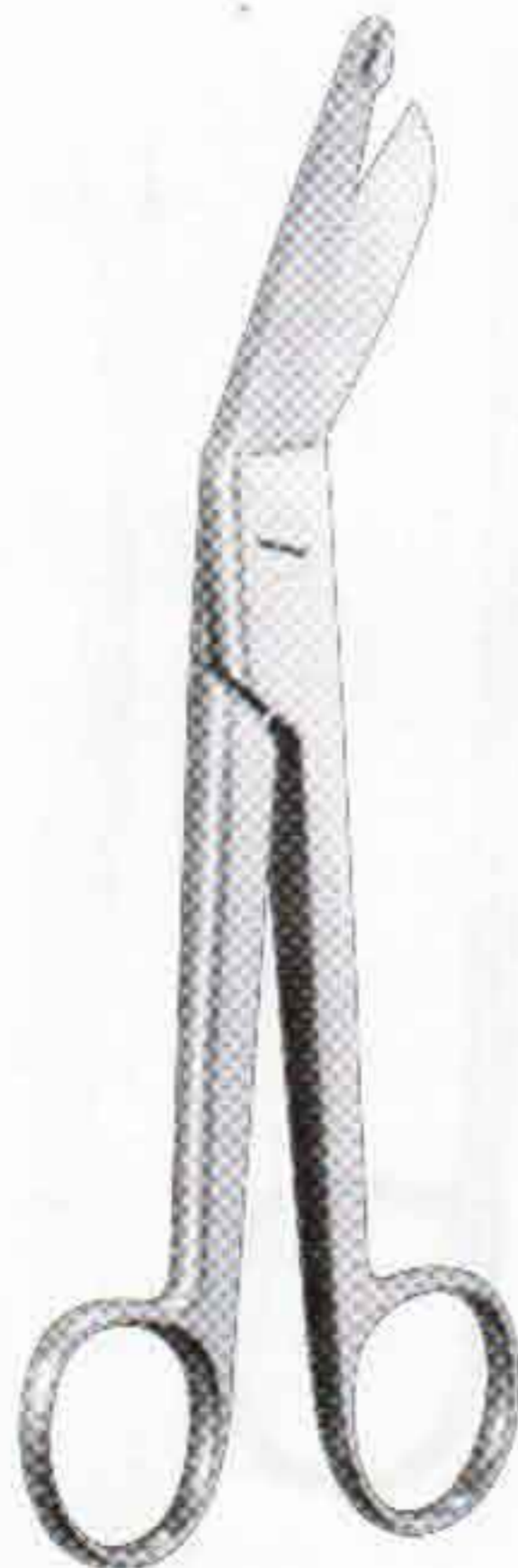

**ESMARCH**  
03-1160  
20 cm, 8"  
03-1161  
22 cm, 8 ¾"



**BRAUN-STADLER**  
03-1170  
14 cm, 5 ½"

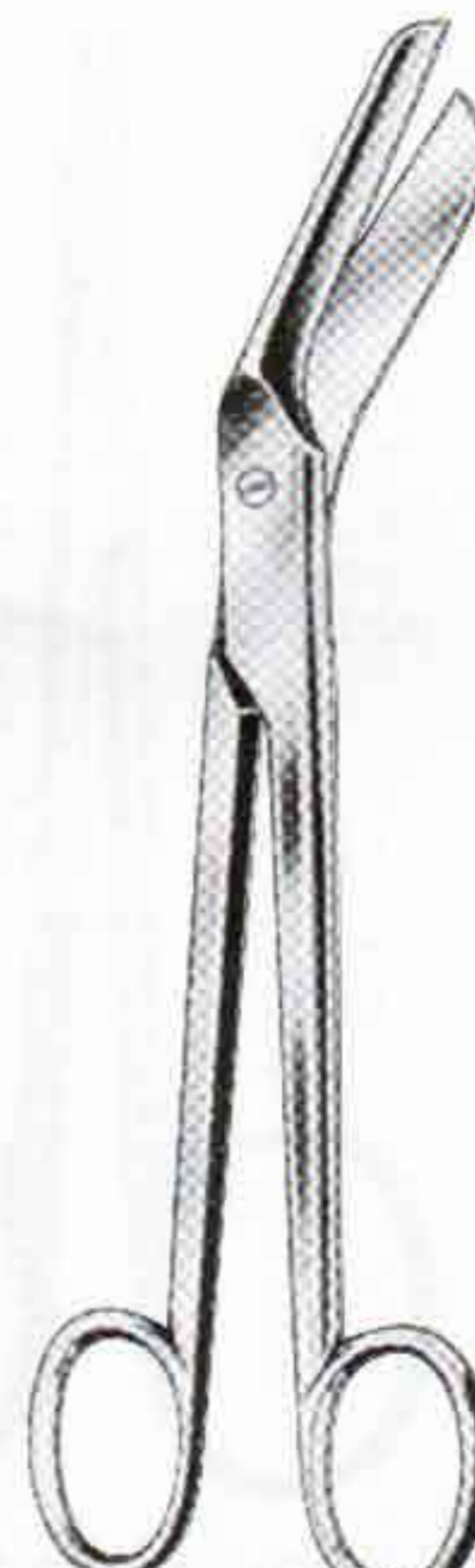

**BRAUN-STADLER**  
03-1180  
20 cm, 8"

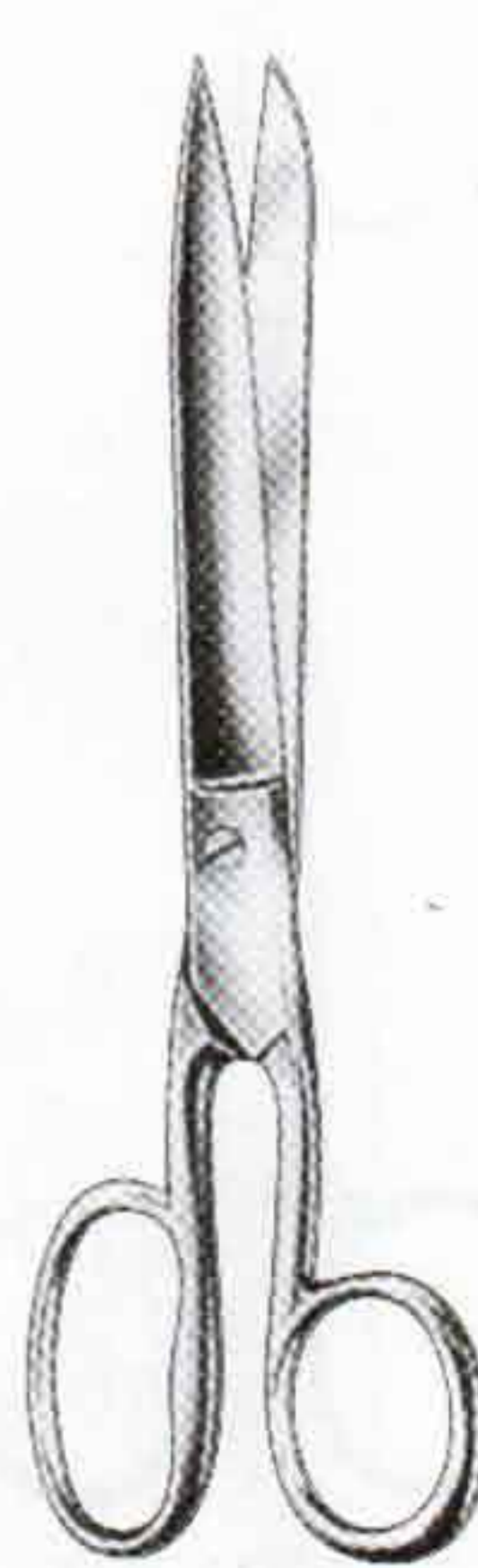

**SMITH (MOD. USA)**  
03-1190 16 cm, 6 ¼"  
03-1191 18 cm, 7"  
03-1192 20 cm, 8"  
03-1193 23 cm, 9"



# PLASTER SCISSORS

Gipsschere  
Tijera para yeso

Ciseaux pour plâtre  
Forbici per gesso

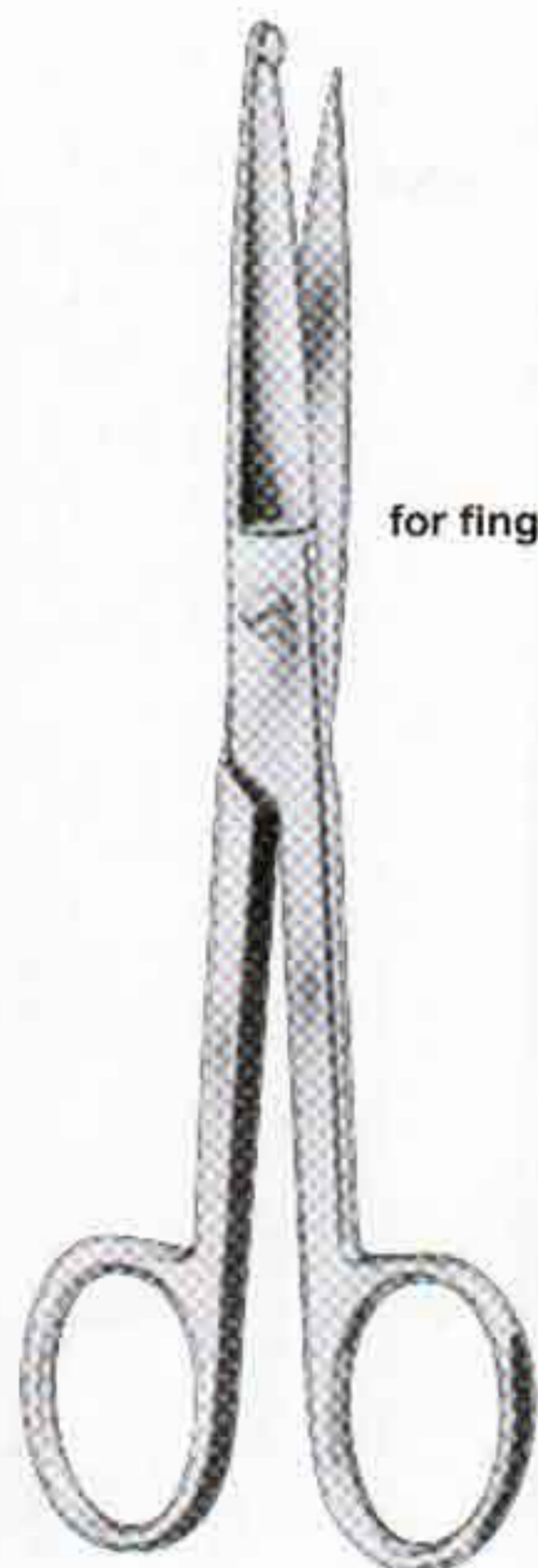

for fingers

**KNOWLES**  
03-1200  
14 cm, 5 1/2"



**LISTER**  
03-1210  
21.0 cm, 8 1/4"

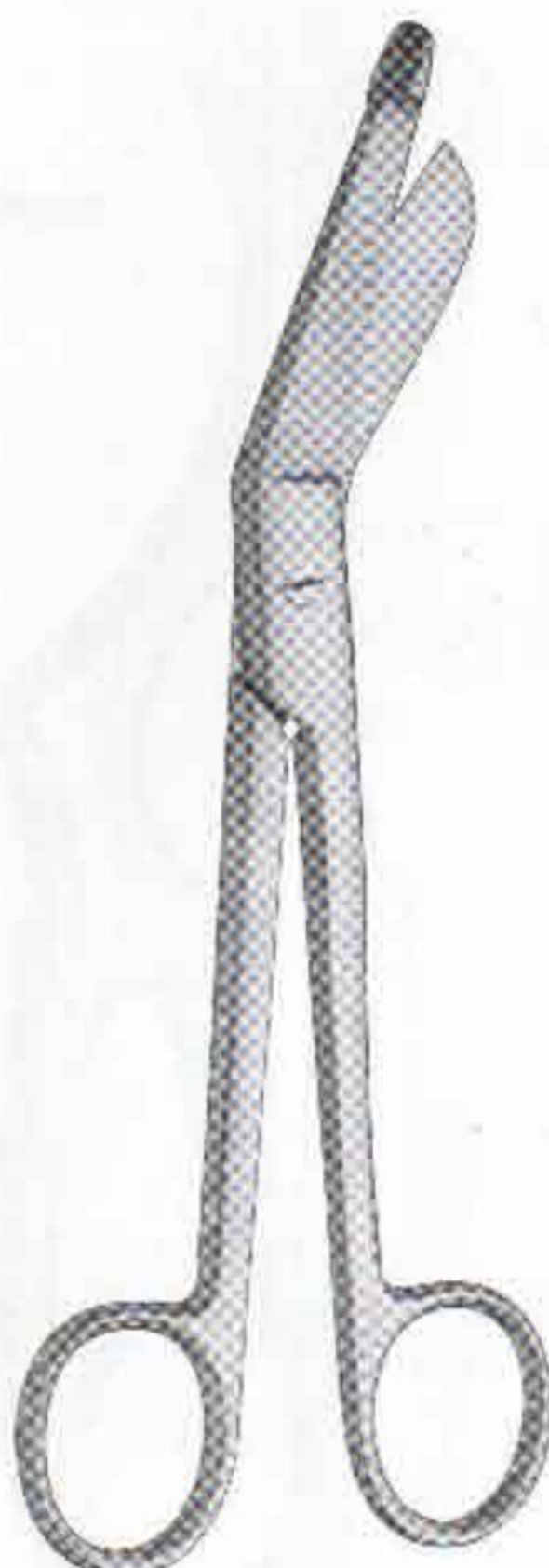

**LISTER BANDAGE**  
03-1220 14 cm, 5 1/2"  
03-1221 16 cm, 6 1/4"  
03-1222 18 cm, 7"  
03-1223 20 cm, 8"

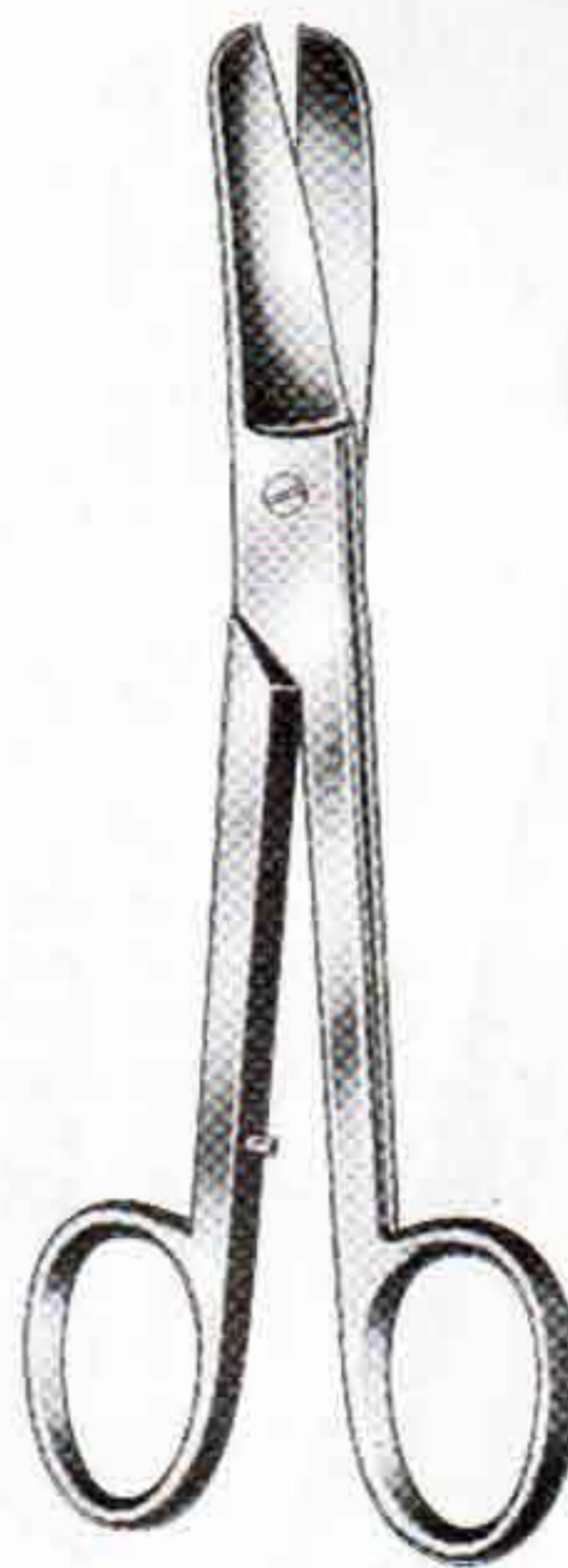

**LORENZ**  
03-1230  
23 cm, 9"



**KNOWLES**  
03-1240  
14 cm, 5 1/2"

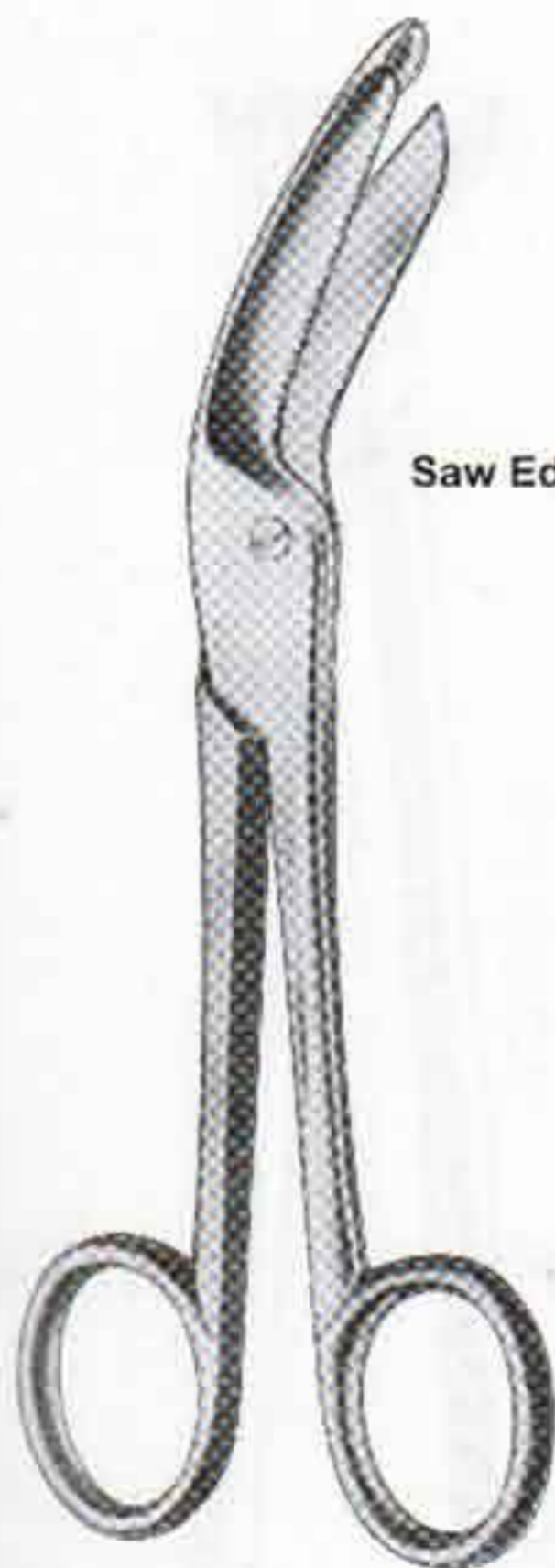

Saw Edge

**LISTER-EXCENTRIC**  
03-1250 16 cm, 6 1/4"  
03-1251 19 cm, 7 1/2"



**KNOWLES**  
03-1260  
14cm



**ESMARCH**  
03-1270  
20cm



**SEUTIN**  
03-1280  
23cm

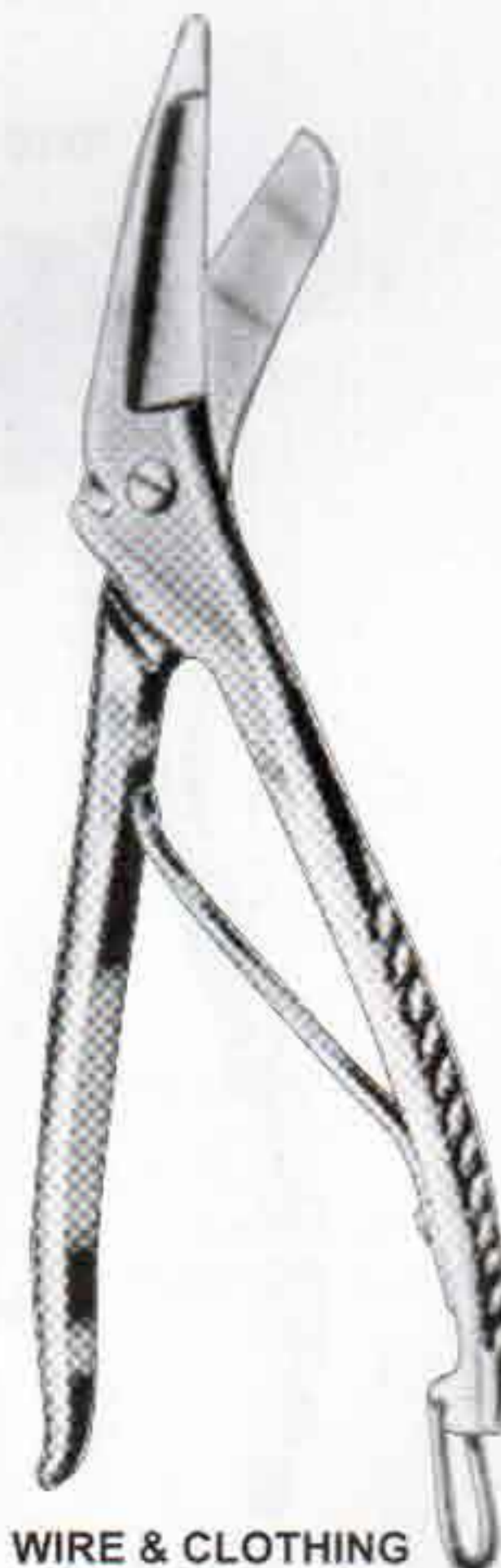

**WIRE & CLOTHING**  
03-1290  
20cm



# PLASTER SHEARS

Gipsschere  
Tijera para yeso

Ciseaux pour plâtre  
Forbici per gesso



SHEAR

**STILLE**  
03-1300 23cm  
03-1301 26cm  
03-1302 37cm

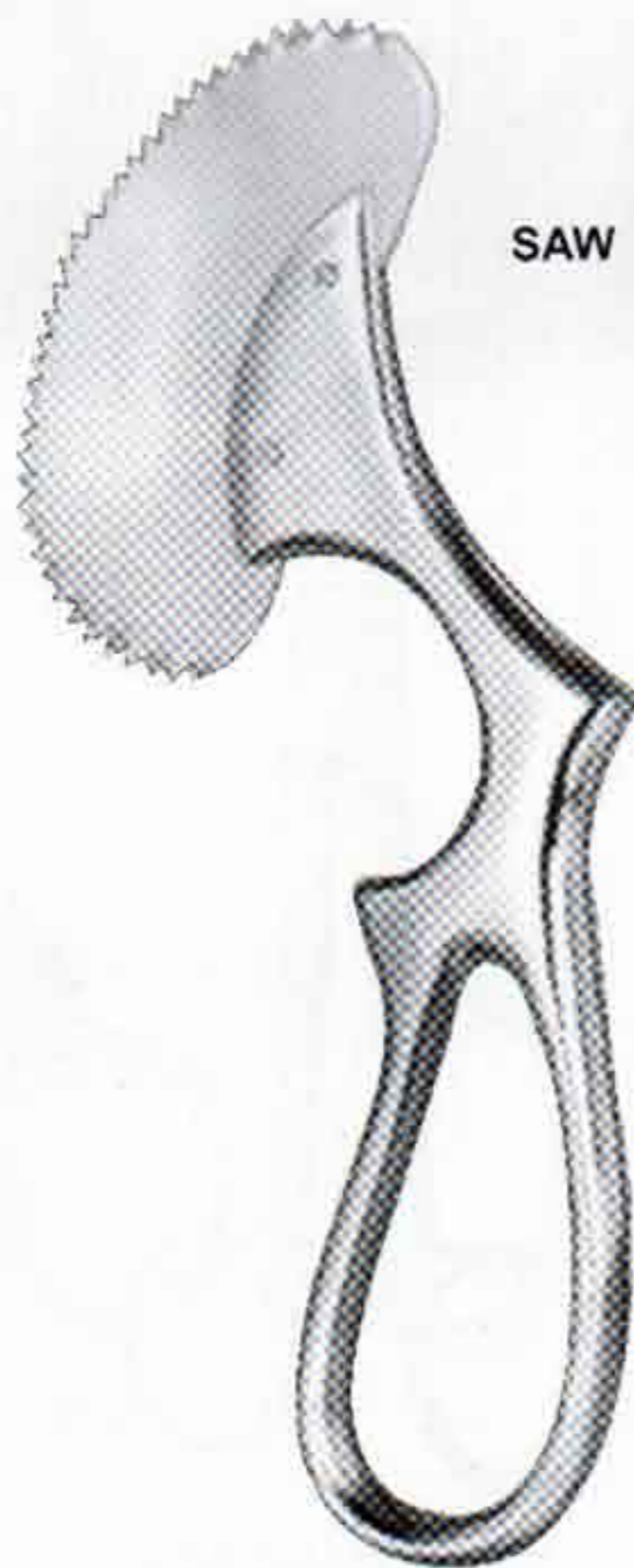

SAW

**ENGEL**  
03-1310



KNIFE

**REINER**  
03-1320  
18cm

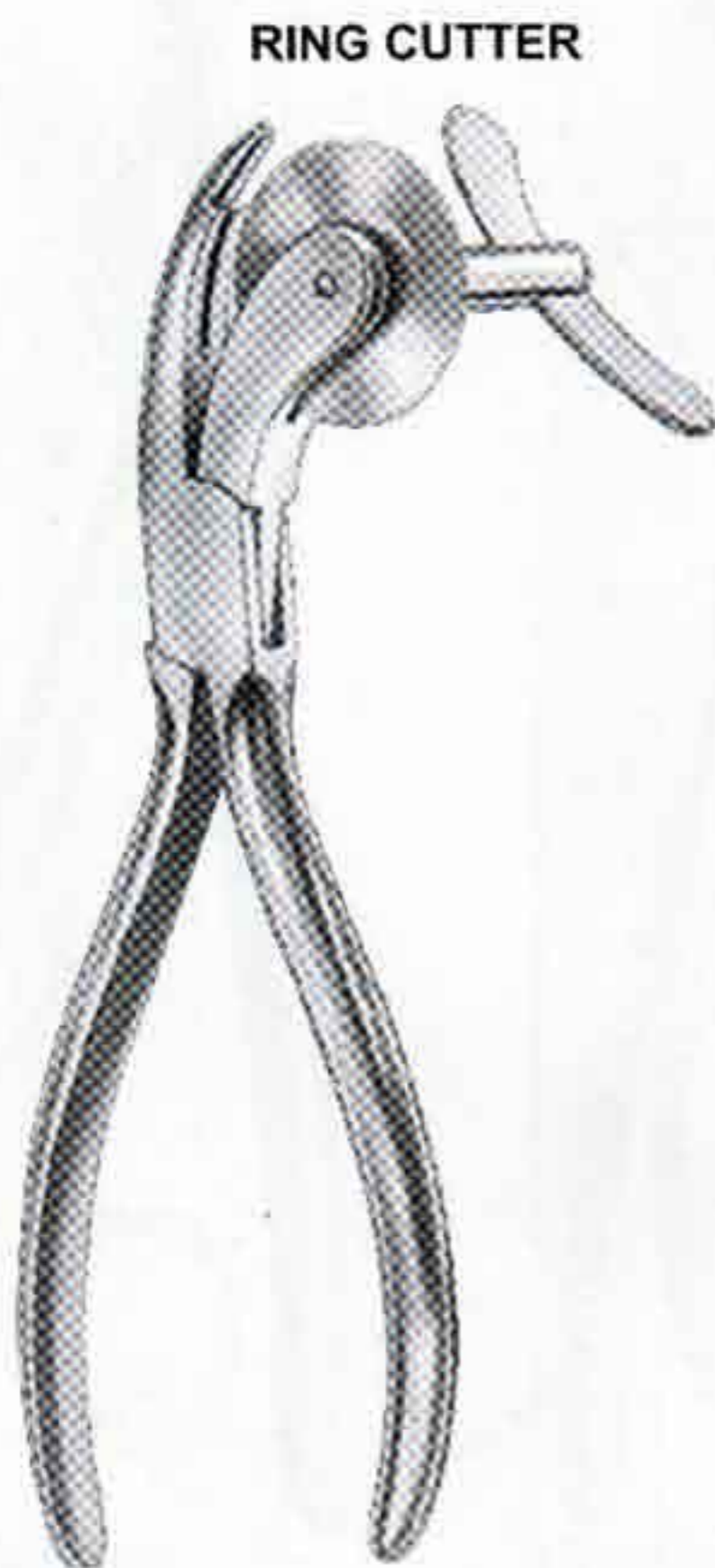

RING CUTTER

**FINGER**  
03-1330  
16cm

CAST BREAKER

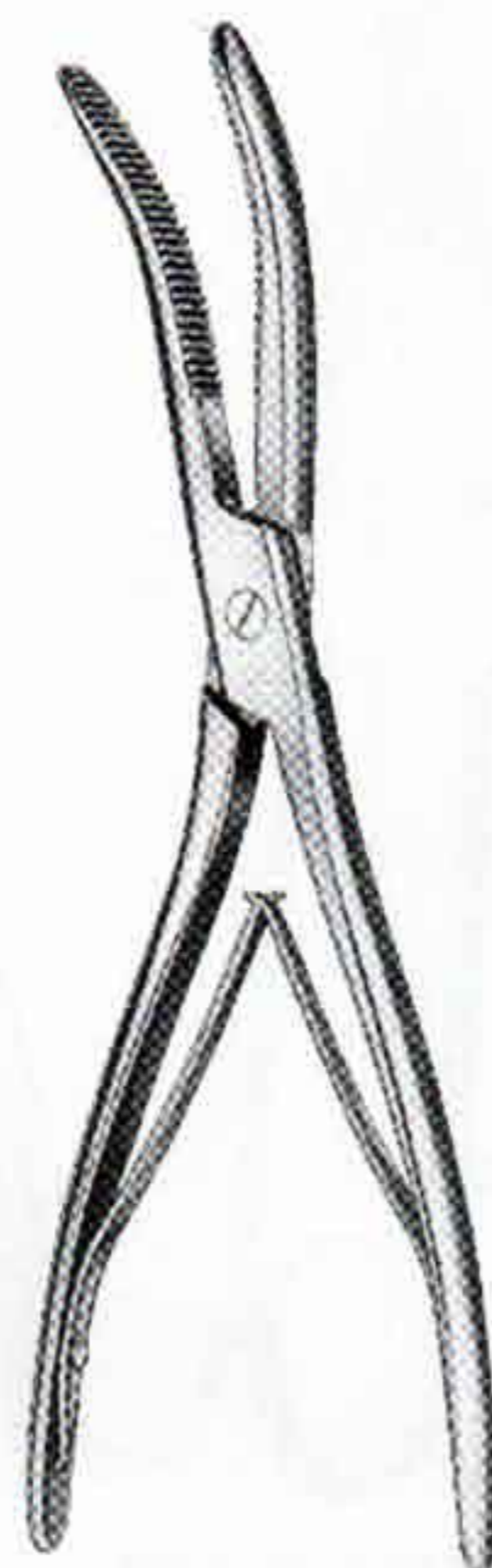

**WOLFF**  
03-1340 19cm  
03-1341 23cm  
03-1342 26cm

SPREADER



**HENING**  
03-1350  
28cm



**BEESON**  
03-1360  
30cm



# OPERATING SCISSORS T/C INSERTED

Chirurgische scheren  
Tijeras quirúrgicas

Ciseaux chirurgicaux  
Forbici per chirurgia



- 03-1370 14.5 cm, 5 3/4" Straight
- 03-1371 14.5 cm, 5 3/4" Curved
- 03-1372 16.5 cm, 6 1/2" Straight
- 03-1373 16.5 cm, 6 1/2" Curved
- 03-1374 18.5 cm, 7 1/4" Straight
- 03-1375 18.5 cm, 7 1/4" Curved

STANDARD

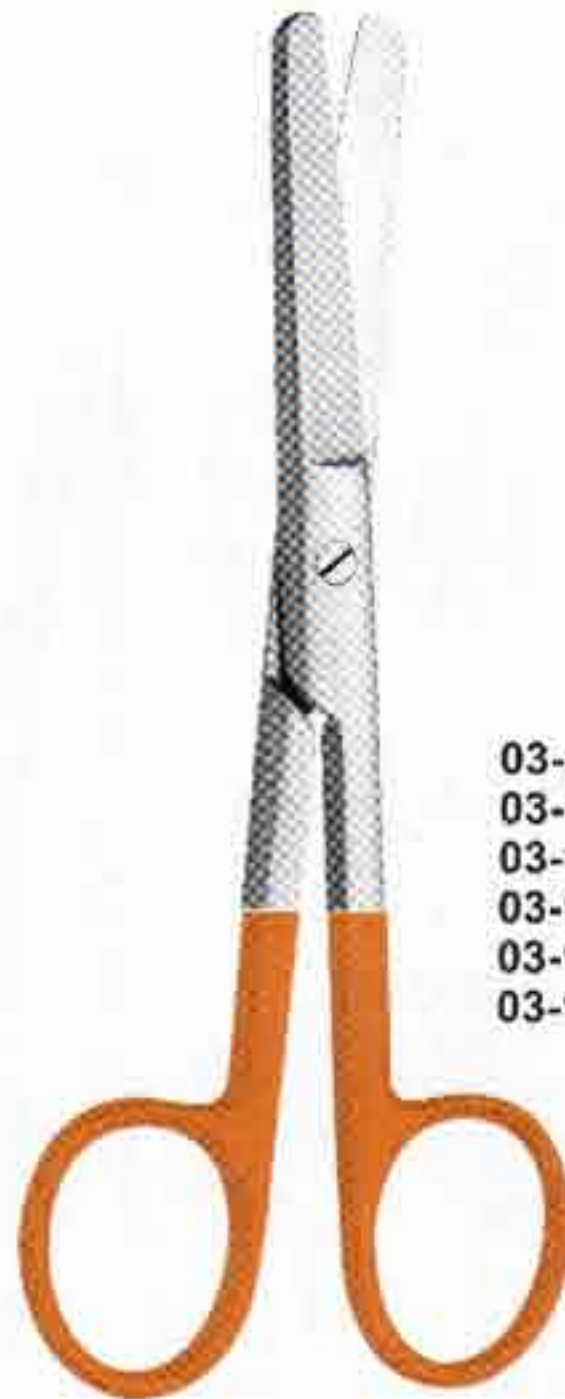

- 03-1390 14.5 cm, 5 3/4" Straight
- 03-1391 14.5 cm, 5 3/4" Curved
- 03-1392 16.5 cm, 6 1/2" Straight
- 03-1393 16.5 cm, 6 1/2" Curved
- 03-1394 18.5 cm, 7 1/4" Straight
- 03-1395 18.5 cm, 7 1/4" Curved

STANDARD



MAYO

- 03-1400 14 cm, 5 1/2" blunt/blunt
- 03-1401 17 cm, 6 3/4" blunt/blunt
- 03-1402 23 cm, 9" blunt/blunt

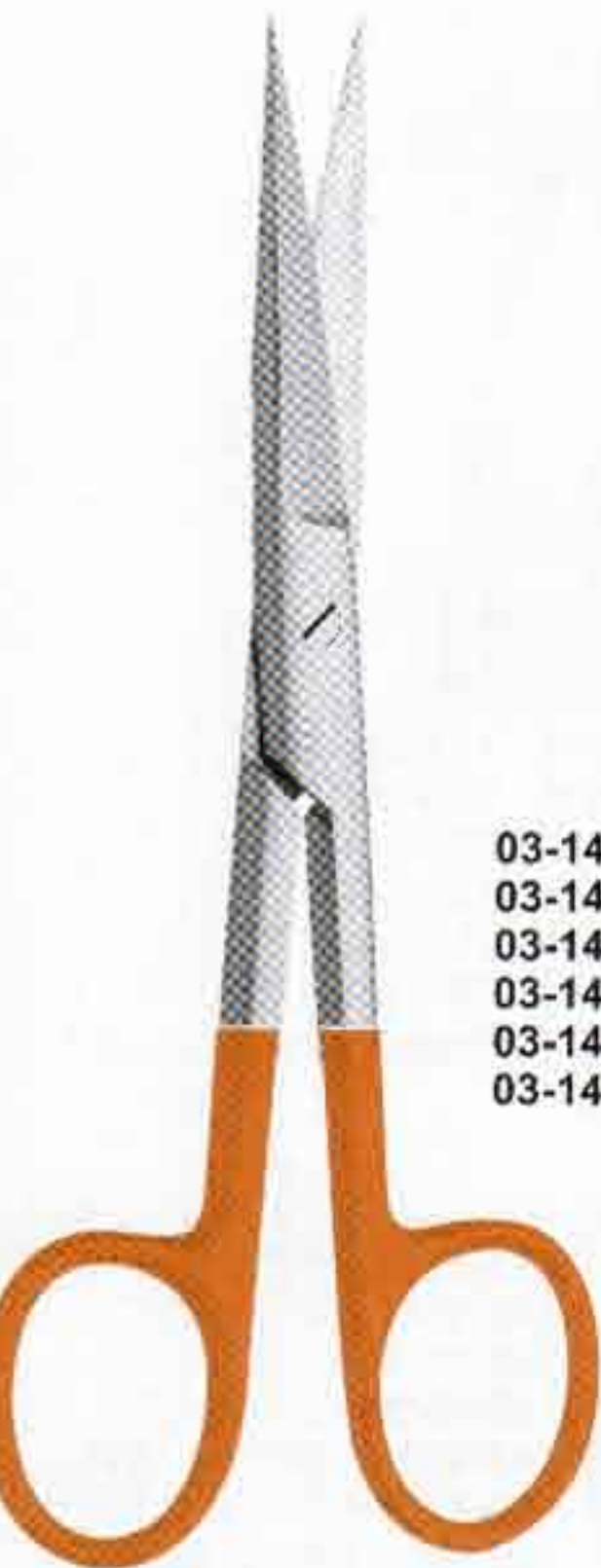

- 03-1410 14.5 cm, 5 3/4" Straight
- 03-1411 14.5 cm, 5 3/4" Curved
- 03-1412 16.5 cm, 6 1/2" Straight
- 03-1413 16.5 cm, 6 1/2" Curved
- 03-1414 18.5 cm, 7 1/4" Straight
- 03-1415 18.5 cm, 7 1/4" Curved

STANDARD



- 03-1432 15 cm, 6" blunt/blunt, Cvd.
- 03-1433 17 cm, 6 3/4" blunt/blunt, Cvd.

MAYO-STILLE

- 03-1430 15 cm, 6" blunt/blunt, Str.
- 03-1431 17 cm, 6 3/4" blunt/blunt, Str.

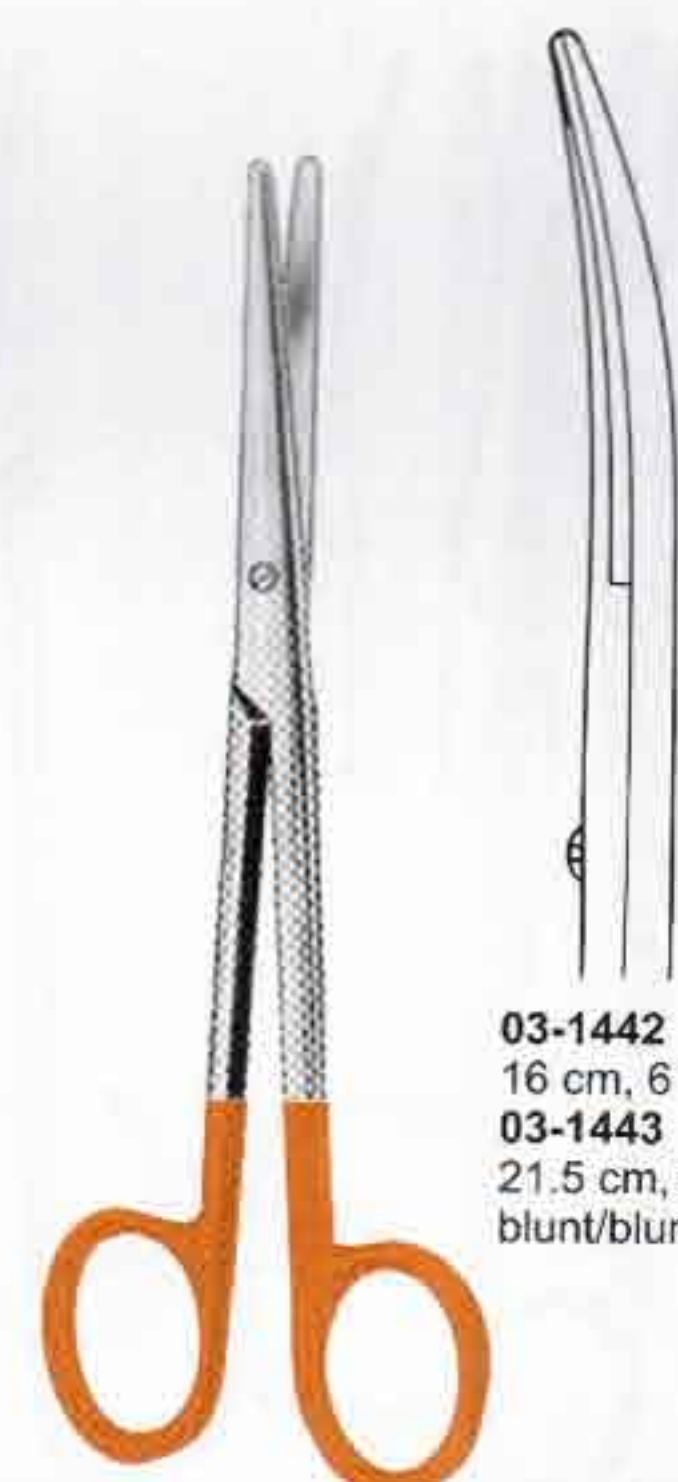

- 03-1442 16 cm, 6 1/4" blunt/blunt, Cvd.
- 03-1443 21.5 cm, 8 1/2" blunt/blunt, Cvd.

LEXER

- 03-1440 16 cm, 6 1/4" blunt/blunt, Str.
- 03-1441 21.5 cm, 8 1/2" blunt/blunt, Str.



# OPERATING & DISSECTING SCISSORS T/C INSERTED

Chirurgische scheren, Präparierscheren  
Tijeras quirúrgicas, Tijeras de disección

Ciseaux chirurgicaux, Ciseaux à dissection  
Forbici per chirurgia, Forbici per dissezione

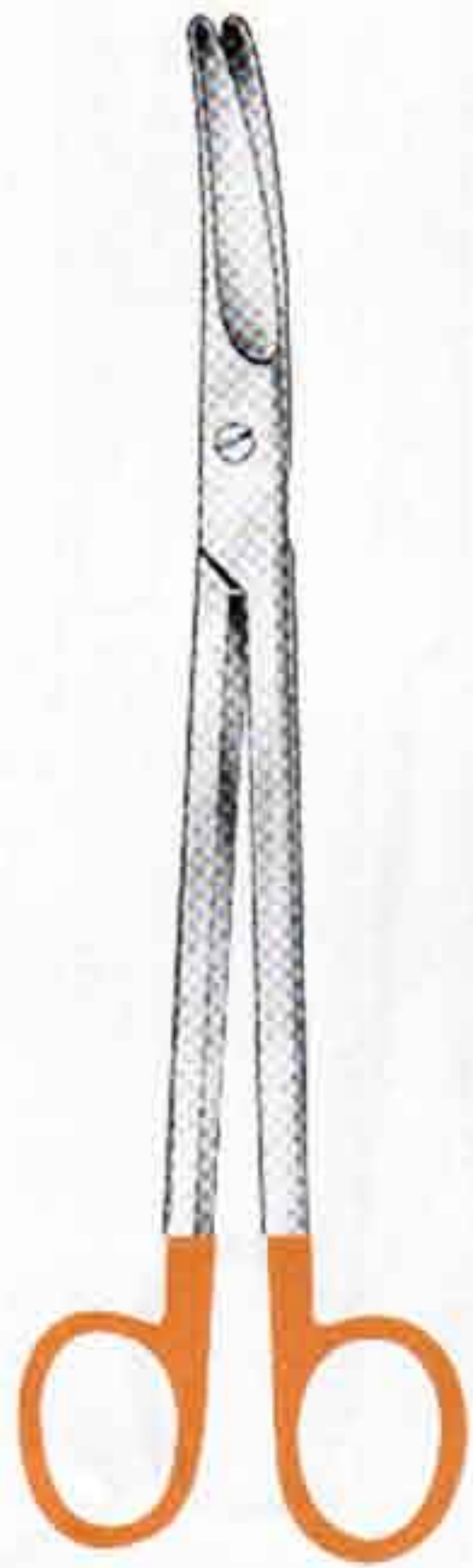

**PARAMETRIUM**  
23 cm, 9"



**03-1450**  
blunt/blunt  
Str.



**03-1451**  
blunt/blunt  
Cvd.

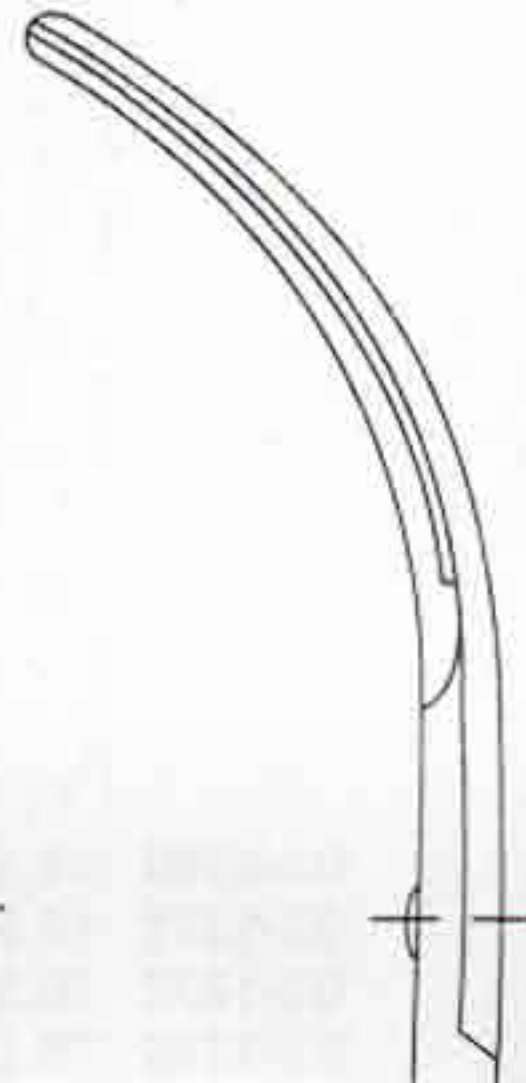

**03-1452**  
blunt/blunt  
Full Cvd.



**GOLDMAN-FOX**  
**03-1460**  
13.0 cm, 5"

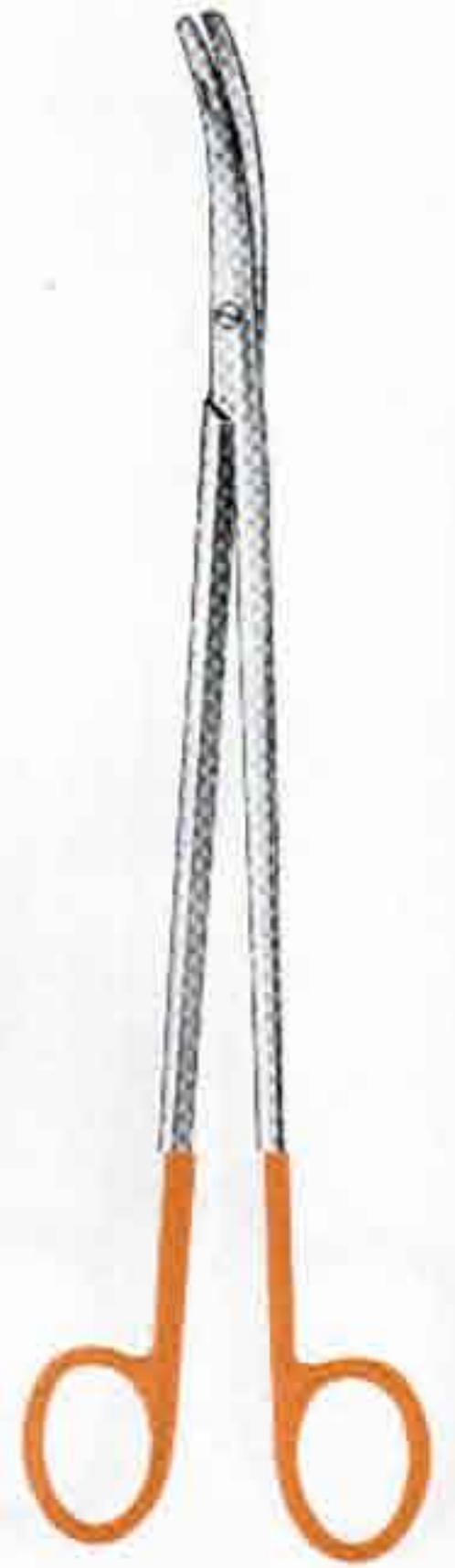

**CARDINALE**  
**03-1470**  
28.0 cm, 11"

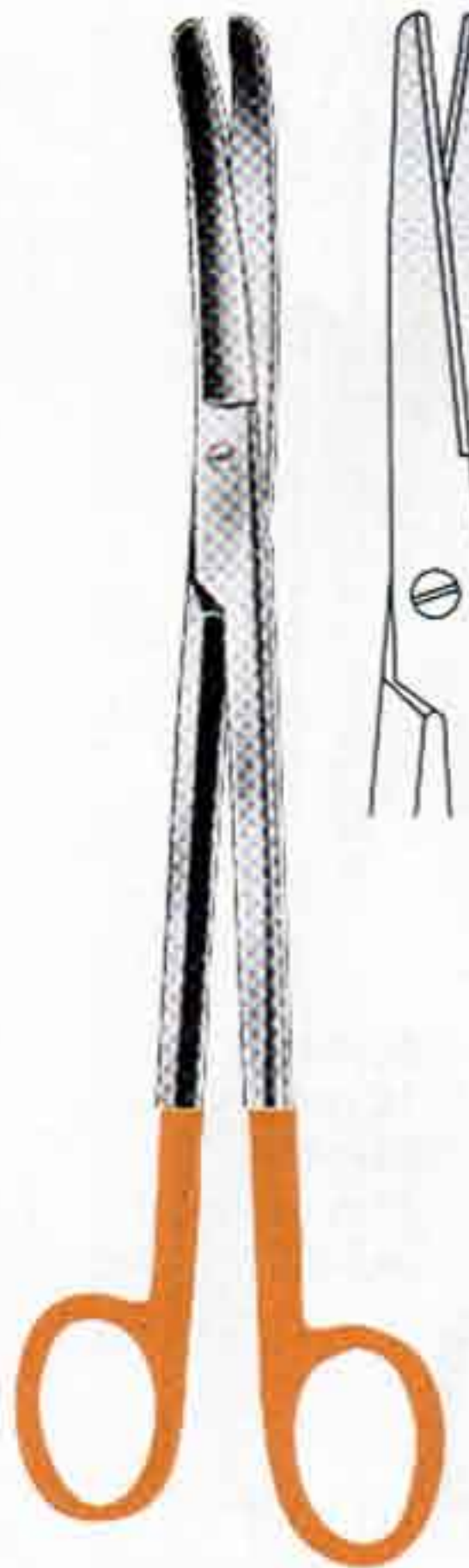

**SIMS**  
**03-1480**  
23.0 cm, 9"  
Curved

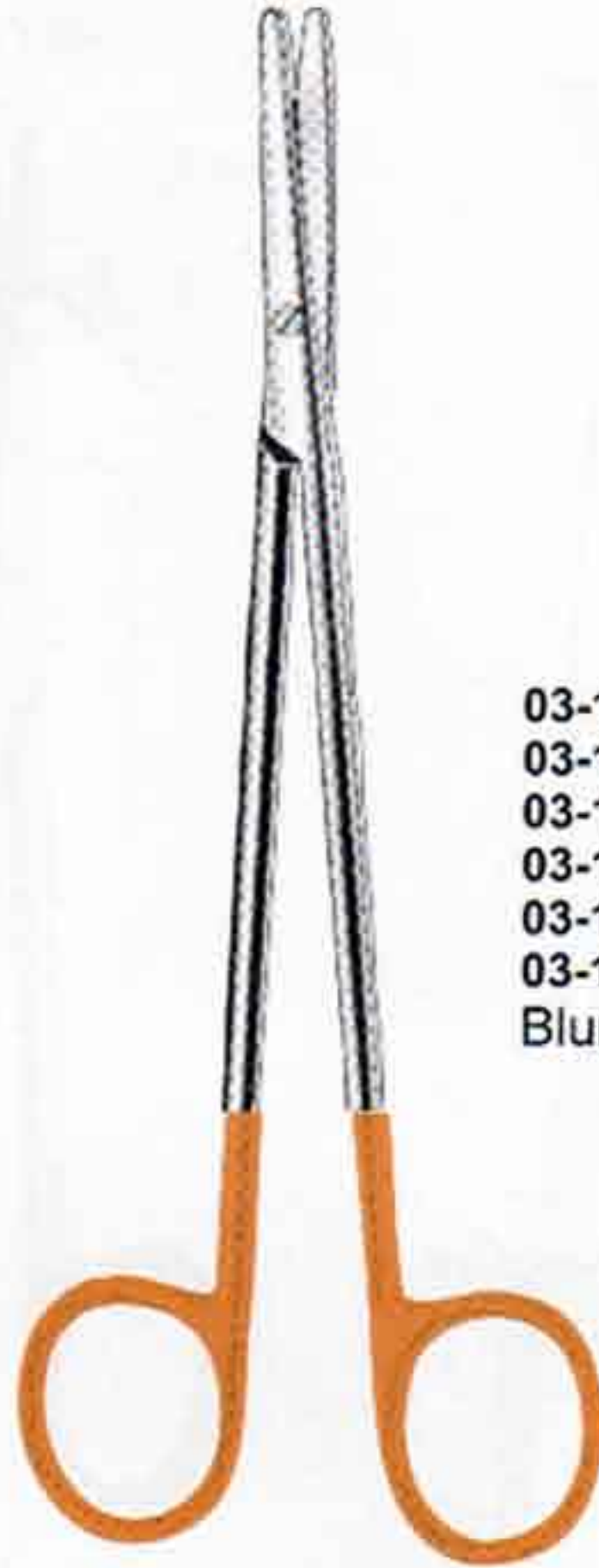
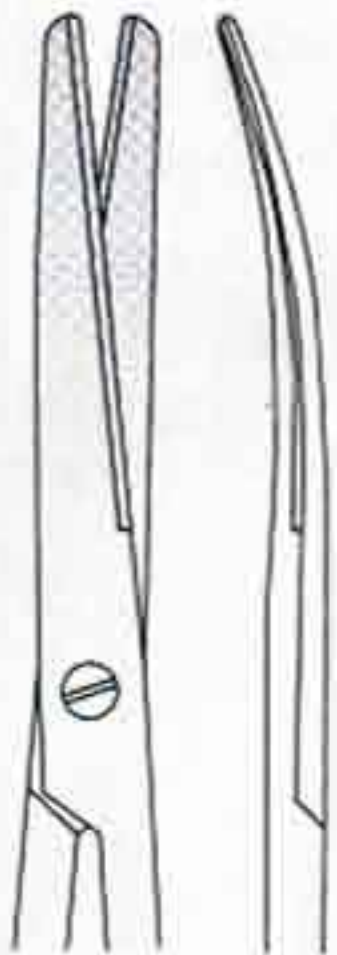

**METZENBAUM  
DELICATE**



**03-1490** 14.5 cm, 5 3/4"  
**03-1491** 18.0 cm, 7"  
**03-1492** 20.0 cm, 8"  
**03-1493** 23.0 cm, 9"  
**03-1494** 25.0 cm, 10"  
**03-1495** 28.0 cm, 11"  
Blunt / Blunt Curved

**03-1496** 14.5 cm, 5 3/4"  
**03-1497** 18.0 cm, 7"  
**03-1498** 20.0 cm, 8"  
**03-1499** 23.0 cm, 9"  
**03-1500** 25.0 cm, 10"  
**03-1501** 28.0 cm, 11"  
Blunt / Blunt Straight

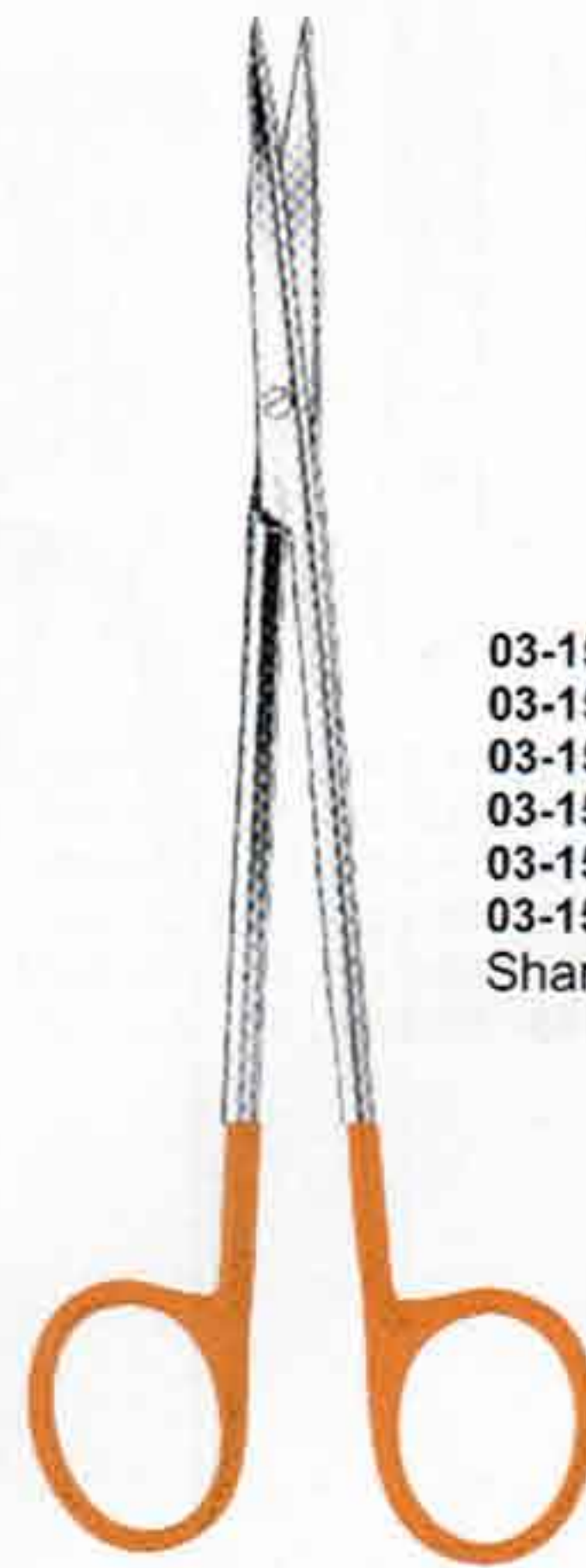

**METZENBAUM  
DELICATE**



**03-1510** 14.5 cm, 5 3/4"  
**03-1511** 18.0 cm, 7"  
**03-1512** 20.0 cm, 8"  
**03-1513** 23.0 cm, 9"  
**03-1514** 25.0 cm, 10"  
**03-1515** 28.0 cm, 11"  
Sharp / Sharp Curved

**03-1516** 14.5 cm, 5 3/4"  
**03-1517** 18.0 cm, 7"  
**03-1518** 20.0 cm, 8"  
**03-1519** 23.0 cm, 9"  
**03-1520** 25.0 cm, 10"  
**03-1521** 28.0 cm, 11"  
Sharp / Sharp Straight



# VASCULAR, DISSECTING & PLASTER SCISSORS T/C INSERTED

Gefäßscheren, Präparierscheren, Gipsschere  
 Tijeras vasculares, Tijeras de disección, Tijera para yeso

Ciseaux vasculaires, Ciseaux à dissection, Ciseaux pour plâtre  
 Forbici vascolari, Forbici per dissezione, Forbici per gesso

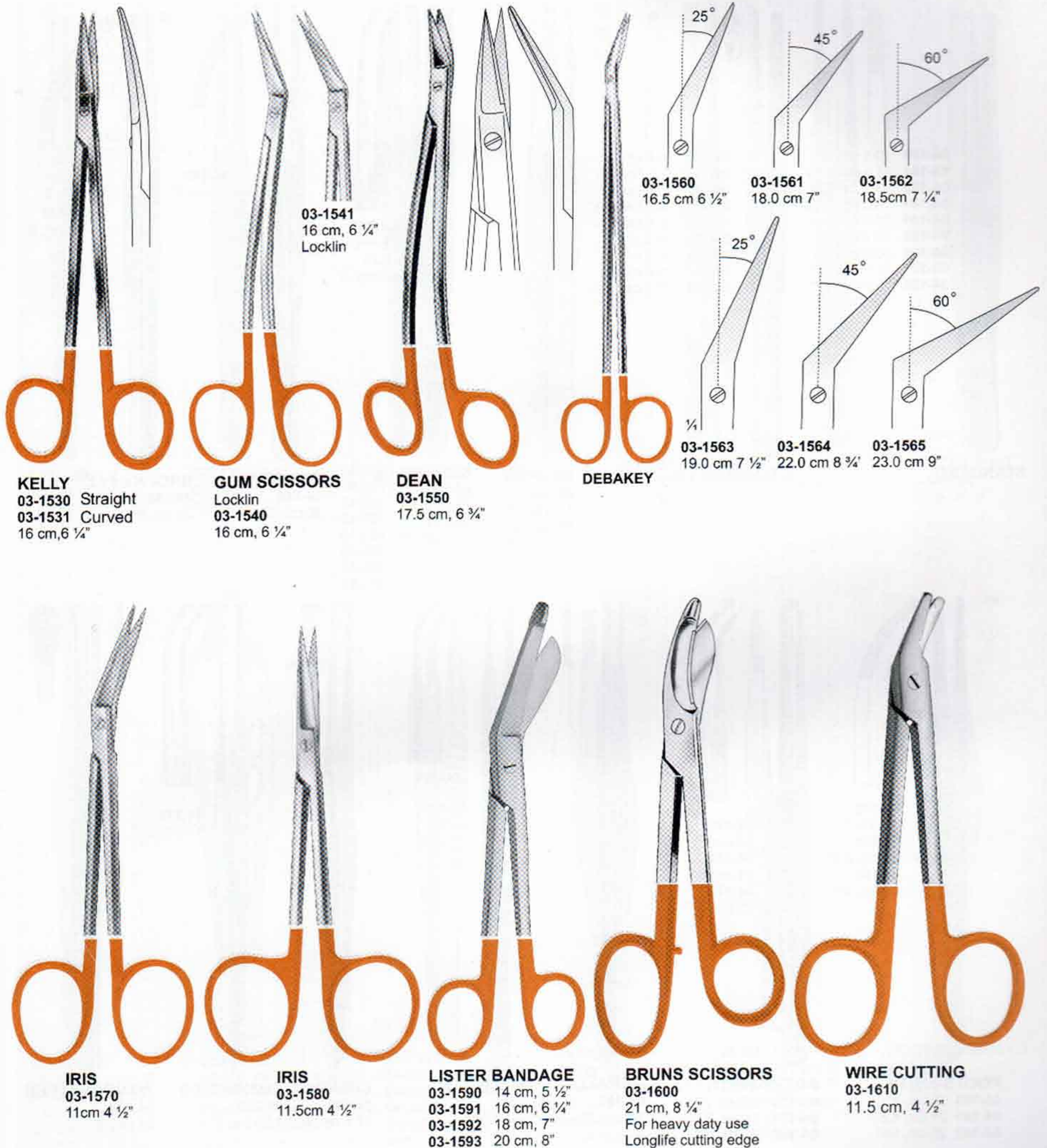

**KELLY**  
 03-1530 Straight  
 03-1531 Curved  
 16 cm, 6 1/4"

**GUM SCISSORS**  
 Locklin  
 03-1540  
 16 cm, 6 1/4"

**DEAN**  
 03-1550  
 17.5 cm, 6 3/4"

**DEBAKEY**

03-1560  
 16.5 cm 6 1/2"

03-1561  
 18.0 cm 7"

03-1562  
 18.5cm 7 1/4"

03-1563  
 19.0 cm 7 1/2"

03-1564  
 22.0 cm 8 3/4"

03-1565  
 23.0 cm 9"

**IRIS**  
 03-1570  
 11cm 4 1/2"

**IRIS**  
 03-1580  
 11.5cm 4 1/2"

**LISTER BANDAGE**  
 03-1590 14 cm, 5 1/2"  
 03-1591 16 cm, 6 1/4"  
 03-1592 18 cm, 7"  
 03-1593 20 cm, 8"

**BRUNS SCISSORS**  
 03-1600  
 21 cm, 8 1/4"  
 For heavy duty use  
 Longlife cutting edge

**WIRE CUTTING**  
 03-1610  
 11.5 cm, 4 1/2"



# DRESSING & TISSUE FORCEPS

Anatomische pinzetten, Pincas a tissu  
Pinzas de disección, Gewebe

Pincas à dissection, Pinzas para tejidos  
Pinze per dissezione, Pinze per tessuti

	<p><b>04-100</b> 10.5 cm, 4" <b>04-101</b> 11.5 cm, 4 1/2" <b>04-102</b> 12.5 cm, 5" <b>04-103</b> 14.0 cm, 5 1/2" <b>04-104</b> 16.0 cm 6 1/4" <b>04-105</b> 18.0 cm, 7" <b>04-106</b> 20.0 cm, 8" <b>04-107</b> 25.0 cm, 10" <b>04-108</b> 30.0 cm, 12"</p>		<p><b>04-110</b> 10.5 cm, 4" <b>04-111</b> 11.5 cm 4 1/2" <b>04-112</b> 12.5 cm 5" <b>04-113</b> 14.0 cm, 5 1/2" <b>04-114</b> 16.0 cm 6 1/4" <b>04-115</b> 18.0 cm, 7" <b>04-116</b> 20.0 cm, 8" <b>04-117</b> 25.0 cm. 10" <b>04-118</b> 30.0 cm, 12"</p>				<p><b>04-132</b> 12.5 cm, 5" <b>04-133</b> 15.0 cm, 6"</p>			<p><b>04-141</b> 20 cm, 8"</p>			<p><b>04-151</b> 20 cm, 8"</p>						
<b>STANDARD</b>		<b>STANDARD 1:2</b>		<b>SEMKEN</b>	<b>SEMKEN 1:2</b>		<b>BROPHY</b>	<b>BROPHY 1 : 2</b>											
				<p><b>04-120</b> 12.5 cm, 5" <b>04-121</b> 15.5 cm, 6"</p>	<p><b>04-130</b> 12.5 cm, 5" <b>04-131</b> 15.0 cm, 6"</p>		<p><b>04-140</b> 20 cm, 8"</p>	<p><b>04-150</b> 20 cm, 8"</p>											
		<p><b>04-163</b> 18 cm, 7" <b>04-164</b> 21 cm, 8.5" <b>04-165</b> 25 cm, 10"</p>			<p><b>04-173</b> 18 cm, 7" <b>04-174</b> 21 cm, 8" <b>04-175</b> 25 cm, 10"</p>					<p><b>04-191</b> 17 cm, 6.75"</p>					<p><b>04-211</b> 17.5 cm, 7"</p>			<p><b>WANGENSTEEN</b> <b>04-220</b> 23 cm, 9"</p>	
<p><b>POOTS-SMITH</b> <b>04-160</b> 18 cm, 7" <b>04-161</b> 21 cm, 8.5" <b>04-162</b> 25 cm, 10"</p>		<p><b>POTTS-SMITH 1 : 2</b> <b>04-170</b> 18 cm, 7" <b>04-171</b> 21 cm, 8" <b>04-172</b> 25 cm, 10"</p>		<p><b>GERALD</b> <b>04-180</b> 18 cm, 7"</p>	<p><b>GERALD 1 : 2</b> <b>04-190</b> 17 cm, 6.75"</p>		<p><b>CUSHING</b> <b>04-200</b> 17.5 cm, 7"</p>	<p><b>CUSHING 1:2</b> <b>04-210</b> 17.5 cm, 7"</p>											



# TISSUE & DRESSING FORCEPS

Pincas a tissu, Anatomische pinzetten  
Gewebe, Pinzas de disección

Pinzas para tejidos, Pincas à dissection  
Pinze per tessuti, Pinze per dissezione



04-231  
17.5 cm, 7"

**TAYLOR 1:2**  
04-230  
17.5 cm, 7"



**GILLIES 1:2**  
04-240  
15 cm, 6"



04-250 11.5 cm 4 1/2"  
04-251 13.0 cm 5"  
04-252 14.5 cm 5 1/2"  
04-253 16.0 cm 6 1/4"  
04-254 18.0 cm 7"  
04-255 20.0 cm 8"  
04-256 25.0 cm 10"  
04-257 30.0 cm 12"



04-260 13 cm, 5"  
04-261 14.5 cm, 5 1/2"  
04-262 16 cm, 6 1/4"



04-270 13 cm, 5"  
04-271 14.5 cm, 5 1/2"  
04-272 16 cm, 6 1/4"



**STILLE 1:2**  
04-280  
15 cm, 6"



**STILLE 2:3**  
04-290  
15 cm, 6"



**MCINDOE**  
04-300 15.0 cm, 6"  
Dissecting Forceps  
non-toothed,  
serrated jaws.

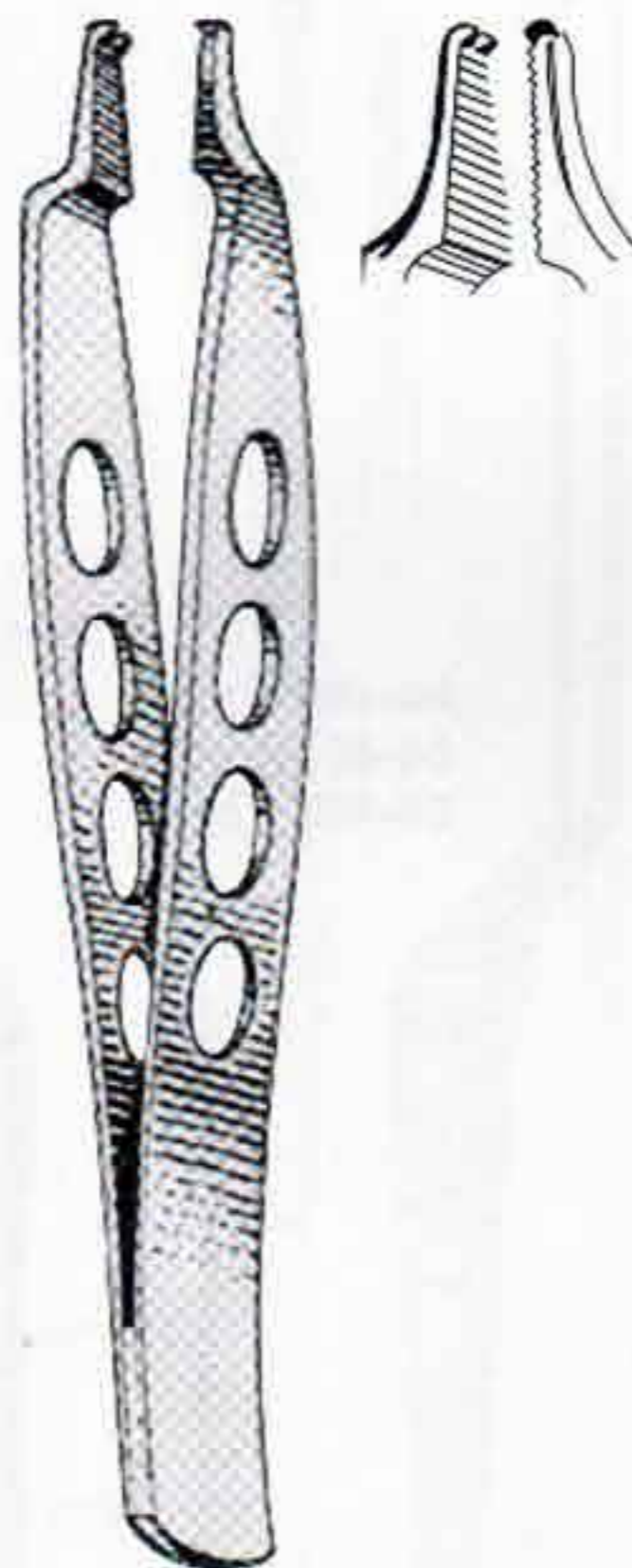

**JEAN 1:2**  
04-310 14.0 cm, 5 1/2"  
04-311 18.0 cm, 7"  
Dissecting Forceps  
one into two teeth on  
serrated jaws.



**TREVES 1:2**  
04-320 12.5 cm, 5"  
04-321 15.0 cm, 6"  
04-322 18.0 cm, 7"  
Dissecting Forceps  
teeth, on smooth jaws.

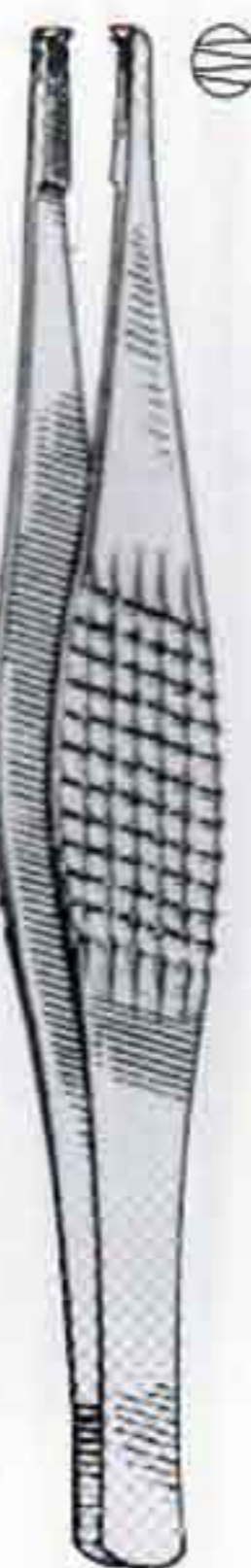

**RAMSAY 1:2**  
04-330 18.0 cm, 7"  
Dissecting Forceps  
one into teeth on  
serrated jaws.  
As above but into  
three teeth.



04-340 12.5 cm, 5"  
04-341 15.0 cm, 6"  
04-342 18.0 cm, 7"  
Dissecting Forceps  
turn over end,  
serrated jaws.



**FERRIS-SMITH 1:2**  
04-350  
18 cm, 7"



# TISSUE & DRESSING FORCEPS

Pinces a tissu, Anatomische pinzetten  
Gewebe, Pinzas de disección

Pinzas para tejidos, Pinces à dissection  
Pinze per tessuti, Pinze per dissezione



04-361  
18 cm, 7"



**LANE 1:2**  
04-370 12.5cm, 5 1/2"  
04-371 15 cm, 6"  
04-372 17 cm, 6 3/4"  
04-373 18 cm, 7"  
04-374 20 cm, 8"

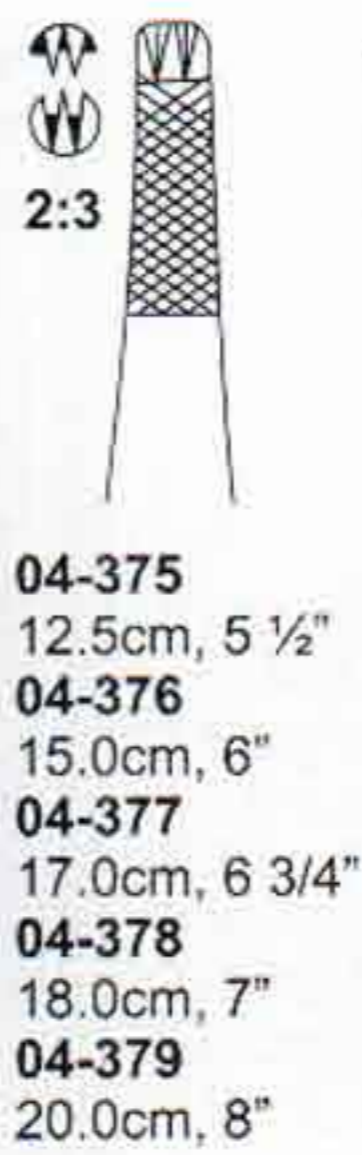

**BONNEY 1:2**  
04-390  
18 cm, 7"

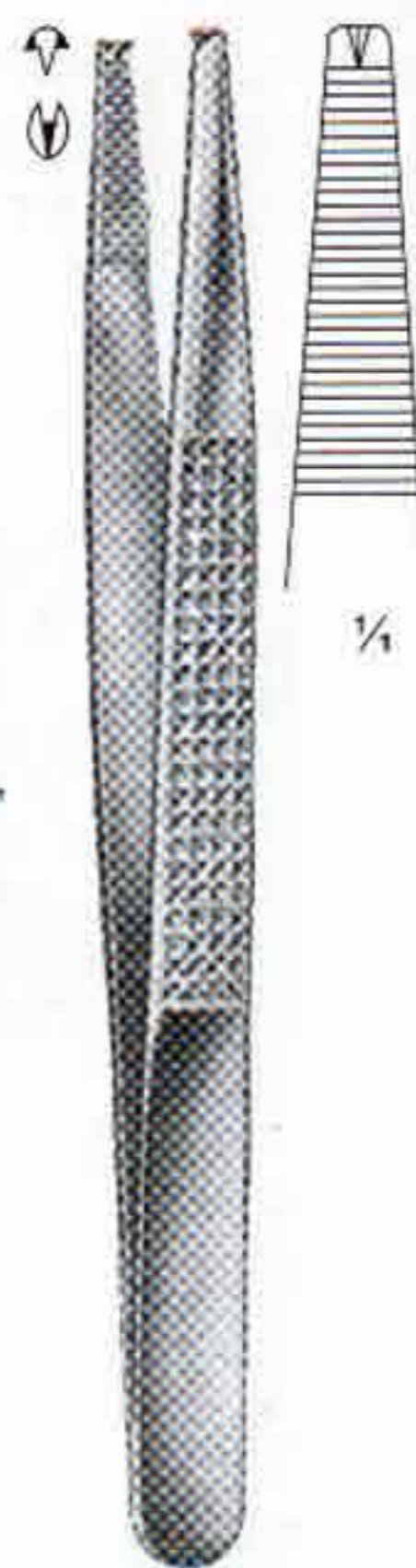

**RUSSIAN-MODELL**  
04-400 15 cm, 5 3/4"  
04-401 20 cm, 8"  
04-402 25 cm, 10"



Grasping,  
Serrated



**DUEHRSEN**

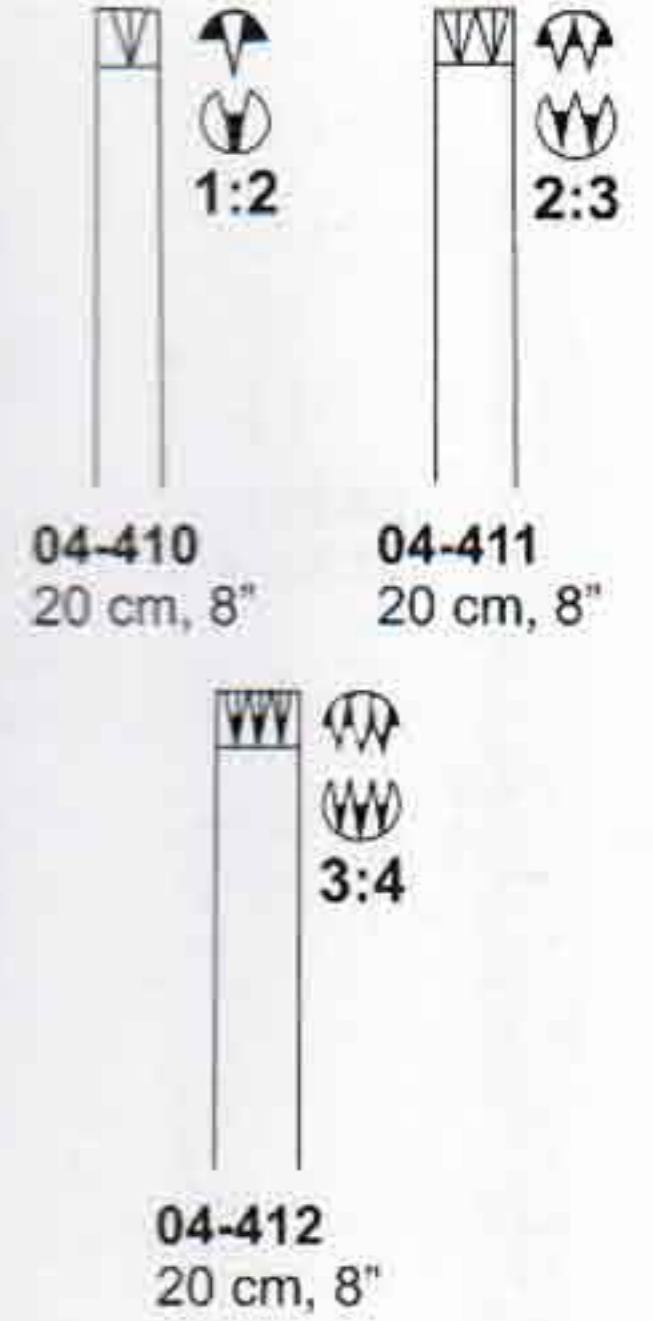

**FERRIS-SMITH 1:2**  
04-360  
18 cm, 7"



**DUEHRSEN**  
04-420  
20 cm, 8"



**MAYO-RUSSIAN**  
04-430  
15.5cm, 6"  
04-431  
23.0cm, 9"



Grasping,  
serrated



**DAVIS**  
04-440  
25 cm, 10"



**COLLIN-DUVAL**



04-450  
20 cm, 8"



04-451  
20 cm, 8"



04-452  
20 cm, 8"



**YASARGIL-SAMI**  
Jaws Spoon-Shaped  
24 cm, 9 1/4"



04-460 3mm  
04-461 5mm  
04-462 7mm



**LUCAE / ENT**



04-470  
14 cm, 5 1/2"  
Dressing,  
Serrated  
04-471  
16 cm, 6 1/2"  
Dressing,  
Serrated



# TISSUE & DRESSING FORCEPS

Pinces a tissu, Anatomische pinzetten  
Gewebe, Pinzas de disección

Pinzas para tejidos, Pinces à dissection  
Pinze per tessuti, Pinze per dissezione

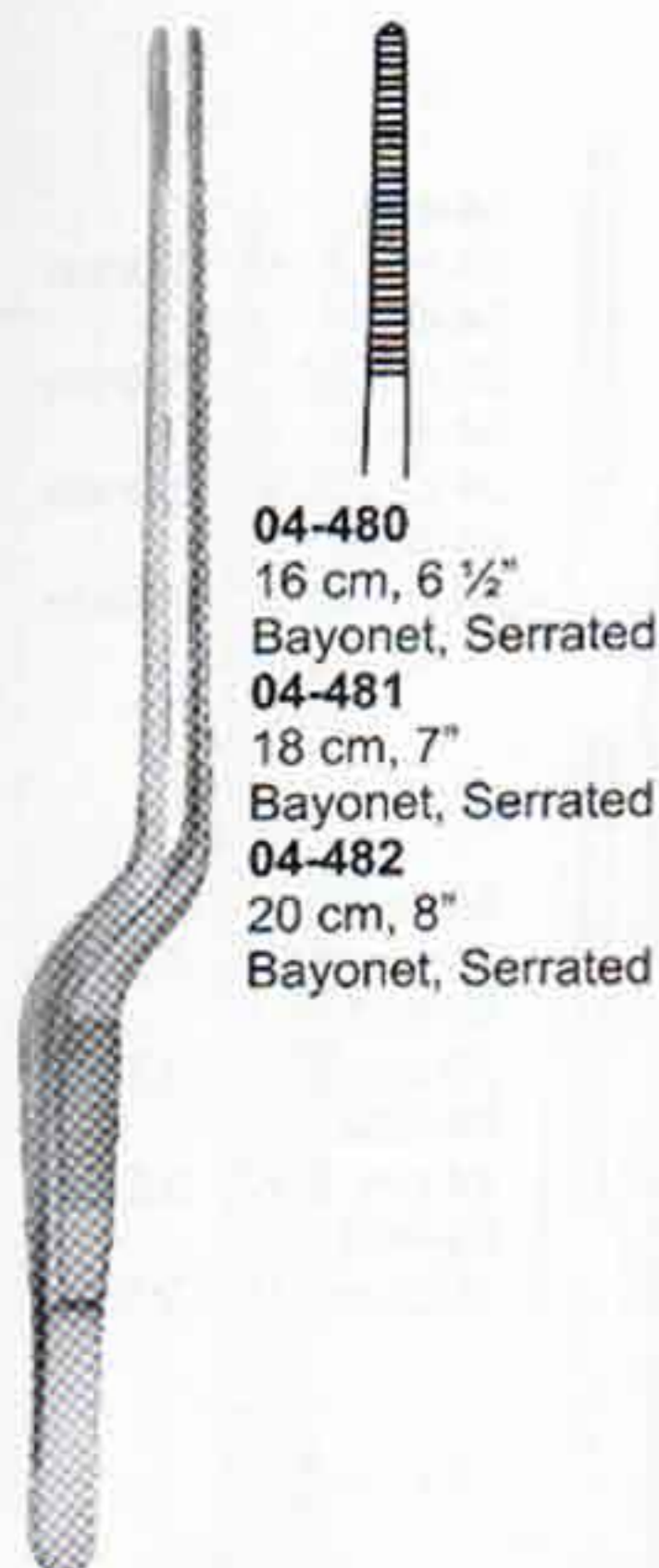

**04-480**  
16 cm, 6 1/2"  
Bayonet, Serrated  
**04-481**  
18 cm, 7"  
Bayonet, Serrated  
**04-482**  
20 cm, 8"  
Bayonet, Serrated

**JANSEN-GRUENWALD**



**04-490**  
12 cm, 5"  
Tissue, 7:7 Teeth  
**04-491**  
12 cm, 5"  
Tissue, 9:9 Teeth

**ADSON-BROWN**



9:9

**ADSON-BROWN**  
**04-500**  
12 cm, 5"



**04-510**  
15 cm, 6"  
Straight, 9:9  
Teeth

**BROWN**



**ADSON / MICRO-ADSON**



**04-520** 12 cm, 5"  
Dressing, serrated  
**04-521** 12 cm, 5"  
Dressing, Micro serrated  
**04-522** 12 cm, 5"  
Dressing, serrated  
tungsten carbide



**04-525** 12 cm, 5"  
Tissue, 1:2 Teeth  
**04-526** 12 cm, 5"  
Tissue, Micro 1:2 Teeth  
**04-527** 12 cm, 5"  
Tissue, 2:3 Teeth

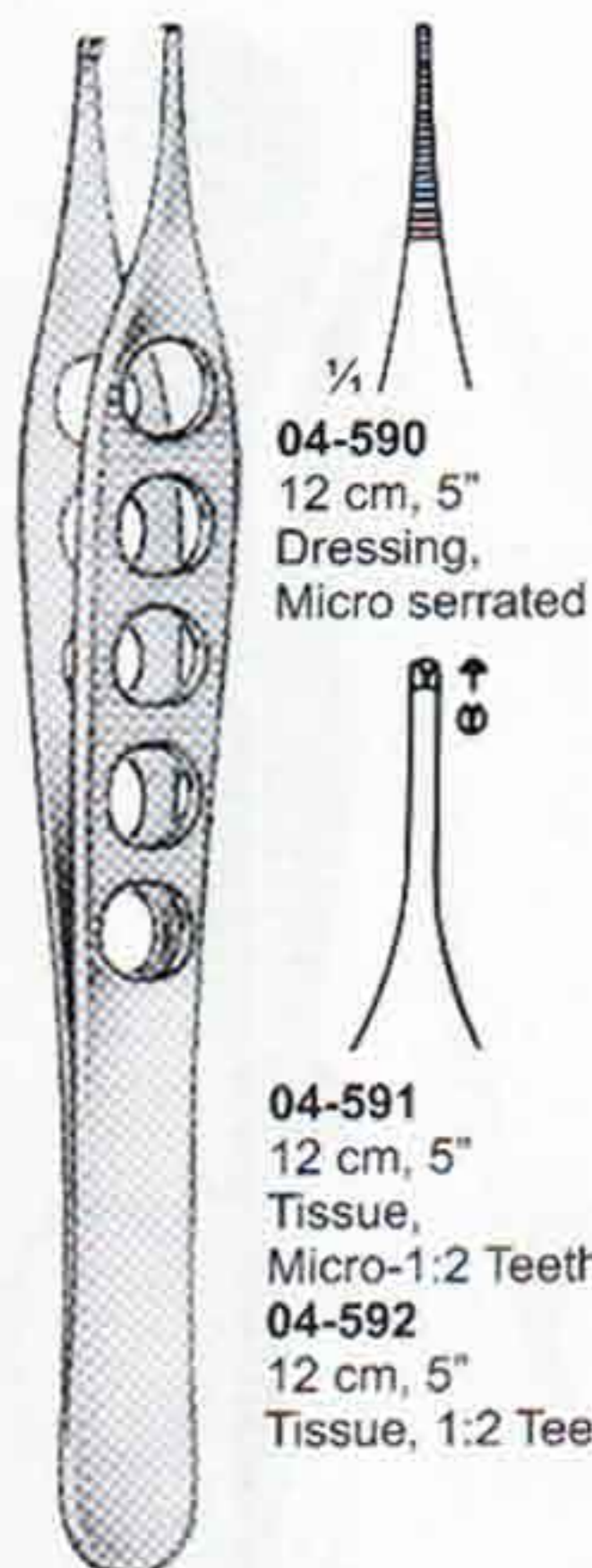

**04-590**  
12 cm, 5"  
Dressing, Micro serrated  
**04-591**  
12 cm, 5"  
Tissue, Micro-1:2 Teeth  
**04-592**  
12 cm, 5"  
Tissue, 1:2 Teeth

**LIGHTWEIGHT-ADSON**



**DE BAKAY / LIGHTWEIGHT**  
**04-600**  
16 cm, 6 1/2"



**DE BAKAY**



**04-610** 1.5mm  
**04-611** 2.0mm  
16 cm, 6 1/2"  
**04-612** 2.0mm  
16 cm, 6 1/2"

**MODELL USA**

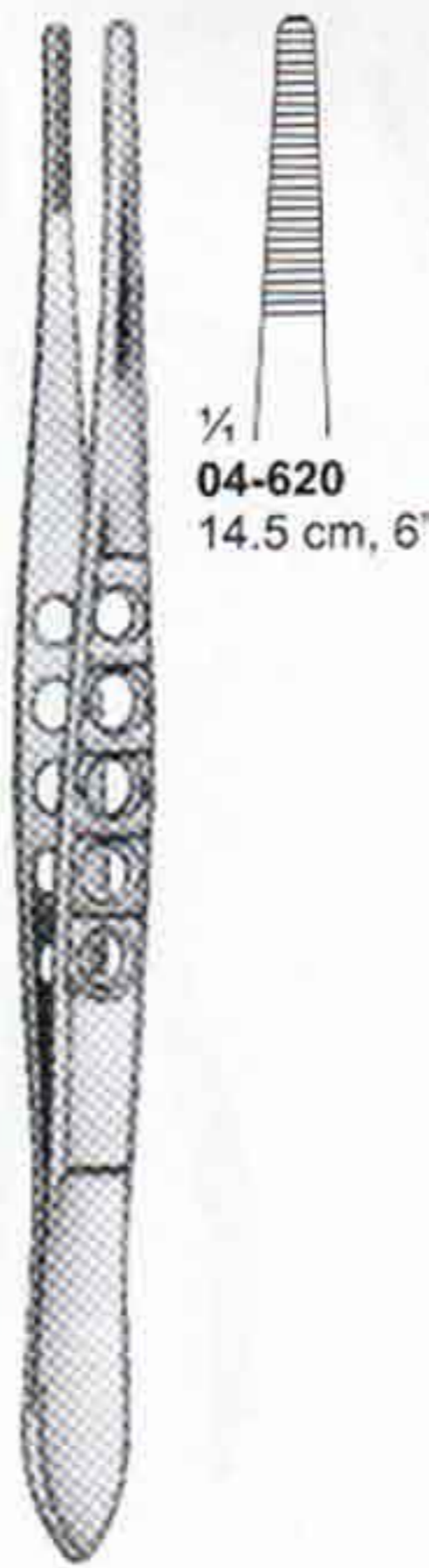

**04-620**  
14.5 cm, 6"

**MODELL USA**



**04-630**  
14.5 cm, 6"  
1:2 teeth



**MCINDOE**  
**04-640**  
15 cm, 6"

**GILLIES**  
**04-645**  
15 cm, 6"  
1:2 teeth



# ATRAUMATIC DRESSING, CILIA, SPLINTER FORCEPS

Atraumatische Pinzette, Cilienpinzetten, Splitterpinzetten  
 Pinza de disección atraumática, Pinzas depilatorias, Pinzas Para espigas

Pince atraumatique à dissection, Pincés à épiler les cils, Pincés à échardes  
 Pinza atraumatica, Pinze depilatoria, Pinze per scheggie

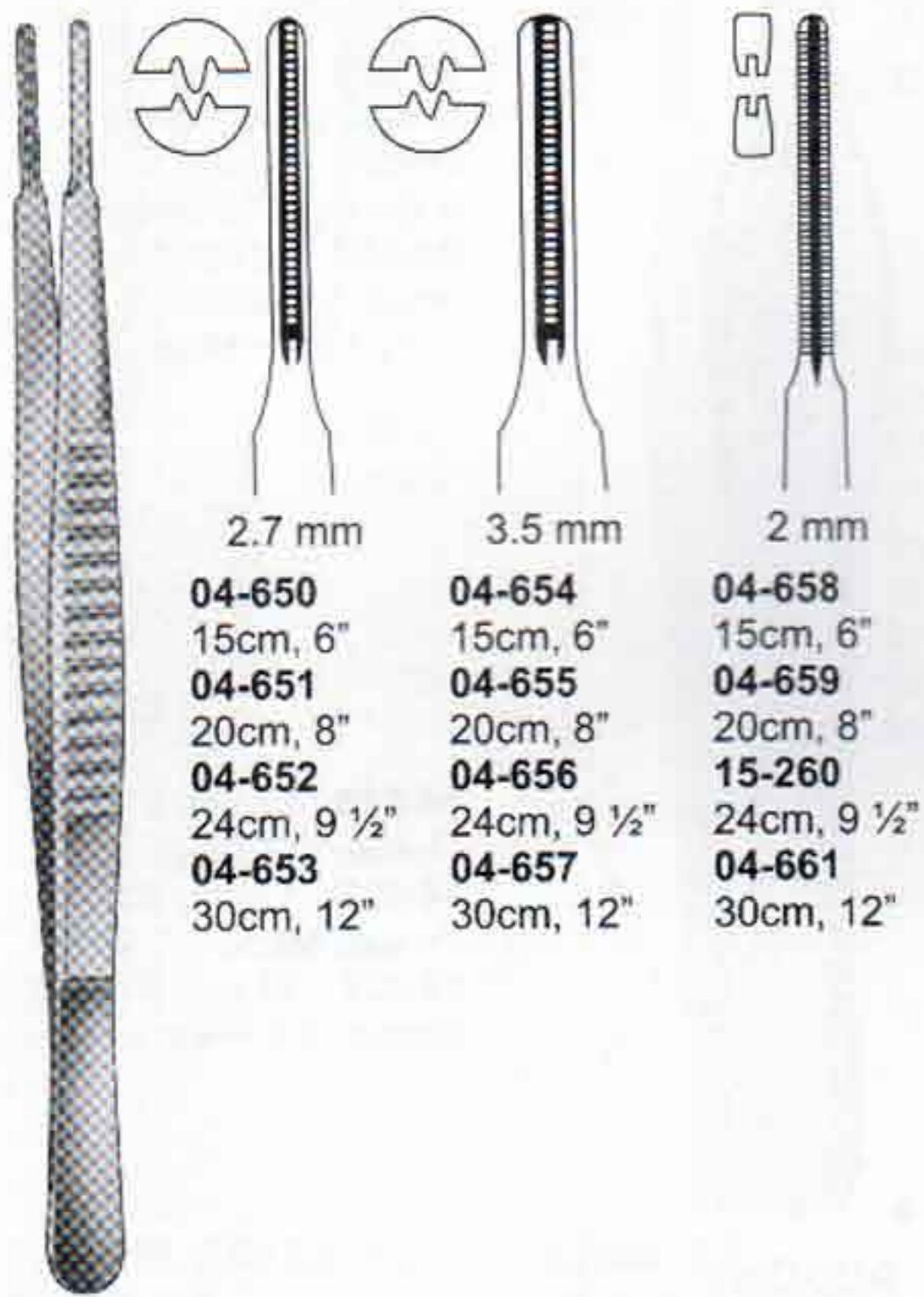

- |                               |                               |                               |
|-------------------------------|-------------------------------|-------------------------------|
| <b>04-650</b><br>15cm, 6"     | <b>04-654</b><br>15cm, 6"     | <b>04-658</b><br>15cm, 6"     |
| <b>04-651</b><br>20cm, 8"     | <b>04-655</b><br>20cm, 8"     | <b>04-659</b><br>20cm, 8"     |
| <b>04-652</b><br>24cm, 9 1/2" | <b>04-656</b><br>24cm, 9 1/2" | <b>15-260</b><br>24cm, 9 1/2" |
| <b>04-653</b><br>30cm, 12"    | <b>04-657</b><br>30cm, 12"    | <b>04-661</b><br>30cm, 12"    |



- 1.2 mm
- 04-670**  
18 cm, 7"
- 04-671**  
21 cm, 8 1/4"



- 2 mm
- 04-672**  
18 cm, 7"
- 04-673**  
21 cm, 8 1/4"

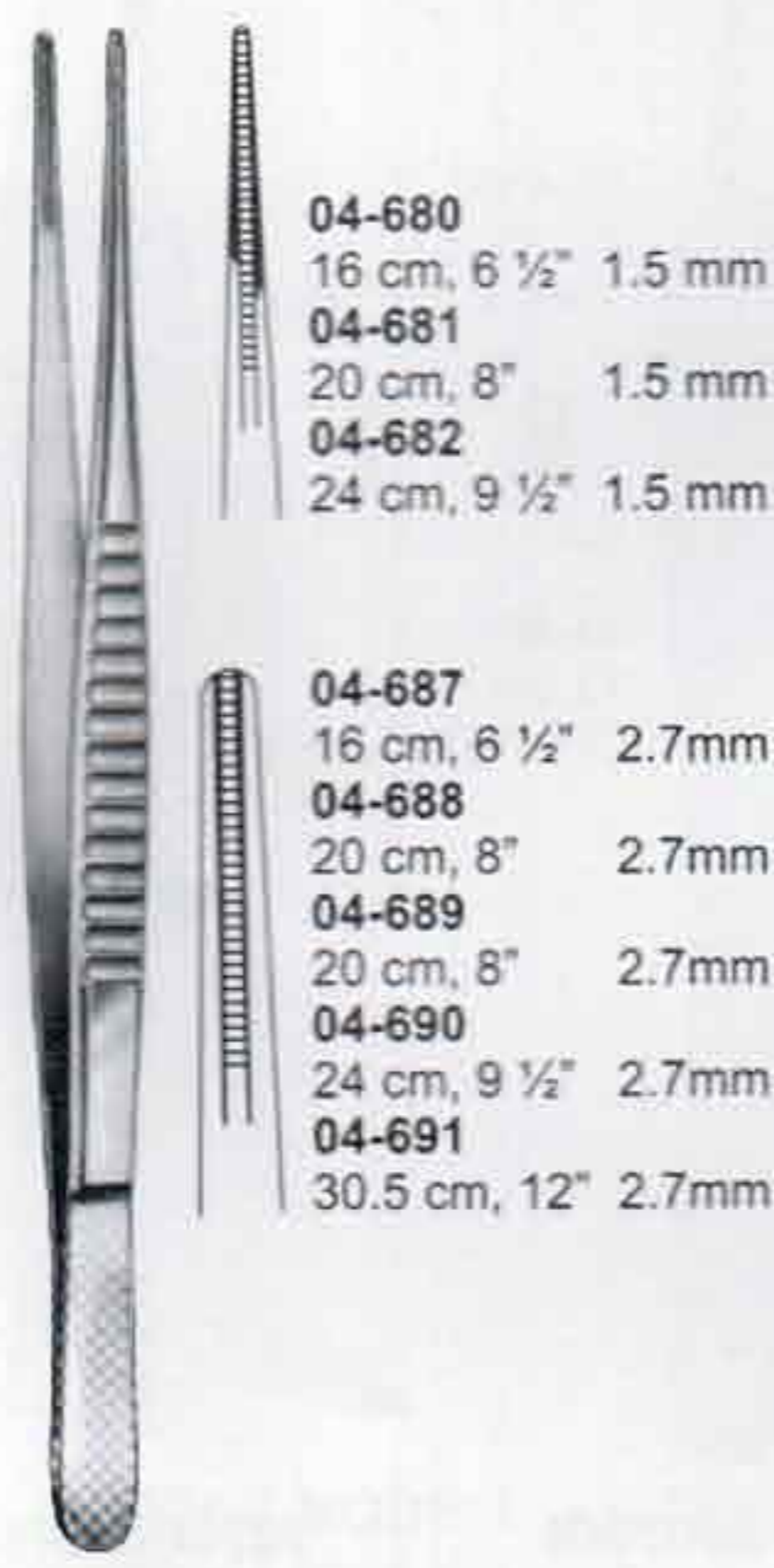

- 04-680**  
16 cm, 6 1/2" 1.5 mm
- 04-681**  
20 cm, 8" 1.5 mm
- 04-682**  
24 cm, 9 1/2" 1.5 mm



- 04-687**  
16 cm, 6 1/2" 2.7mm
- 04-688**  
20 cm, 8" 2.7mm
- 04-689**  
20 cm, 8" 2.7mm Heavy
- 04-690**  
24 cm, 9 1/2" 2.7mm
- 04-691**  
30.5 cm, 12" 2.7mm

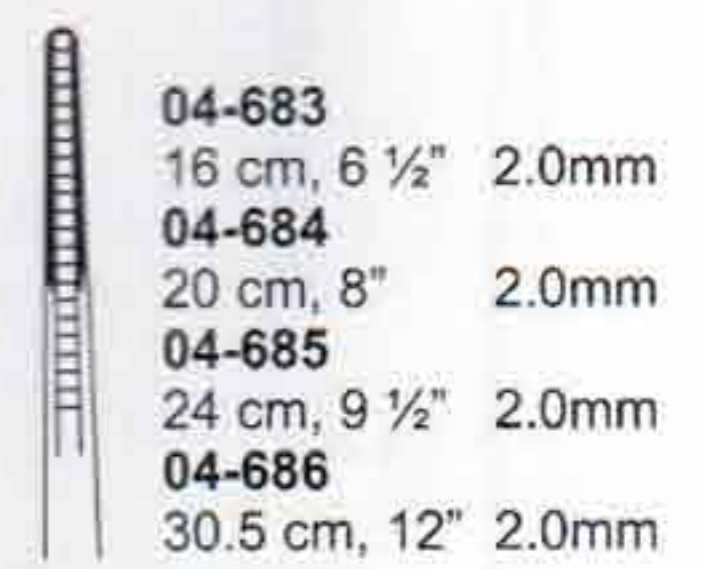

- 04-683**  
16 cm, 6 1/2" 2.0mm
- 04-684**  
20 cm, 8" 2.0mm
- 04-685**  
24 cm, 9 1/2" 2.0mm
- 04-686**  
30.5 cm, 12" 2.0mm

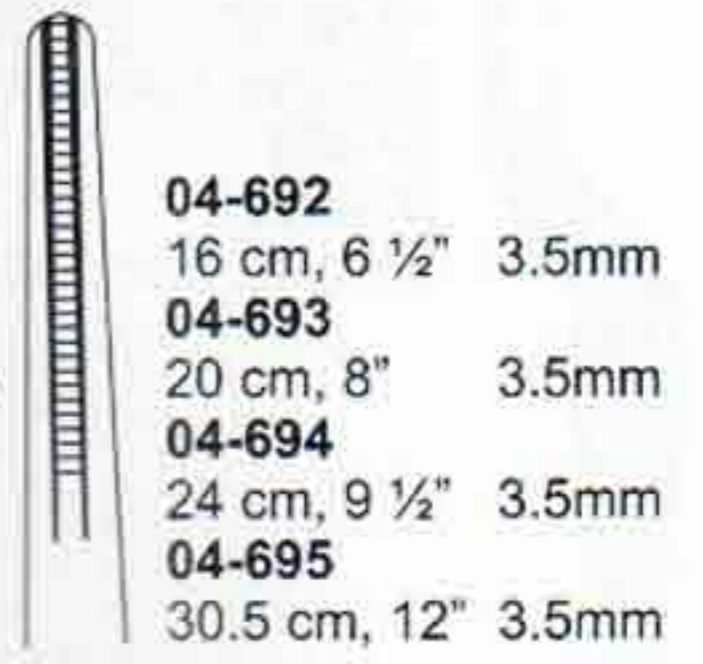

- 04-692**  
16 cm, 6 1/2" 3.5mm
- 04-693**  
20 cm, 8" 3.5mm
- 04-694**  
24 cm, 9 1/2" 3.5mm
- 04-695**  
30.5 cm, 12" 3.5mm

DEBAKEY

DEBAKEY

DEBAKEY



- 2.0mm
- 04-700**  
16 cm, 6 1/2"
- 04-701**  
20 cm, 8"
- 04-702**  
24 cm, 9 1/2"
- 04-703**  
30 cm, 12"

DE BAKEY



- 04-711**  
10.5cm, 4"

KUEHNE  
04-710  
10.5cm, 4"



- 04-720**  
7.5 cm, 3"
- 04-721**  
9 cm, 3 1/2"
- 04-722**  
11 cm, 4"  
Straight

FEILCHENFELD



- 04-731**  
10.5 cm, 4"  
Curved

HUNTER  
04-730  
10.5 cm, 4"  
Straight



STIEGLITZ  
FORCEPS  
04-740  
12.5 cm, 5"



# JEWELER TYPE & SPLINTER FORCEPS

Splitterpinzetten  
Pinzas Para espinas

Pinces à échardes  
Pinze per scheggie

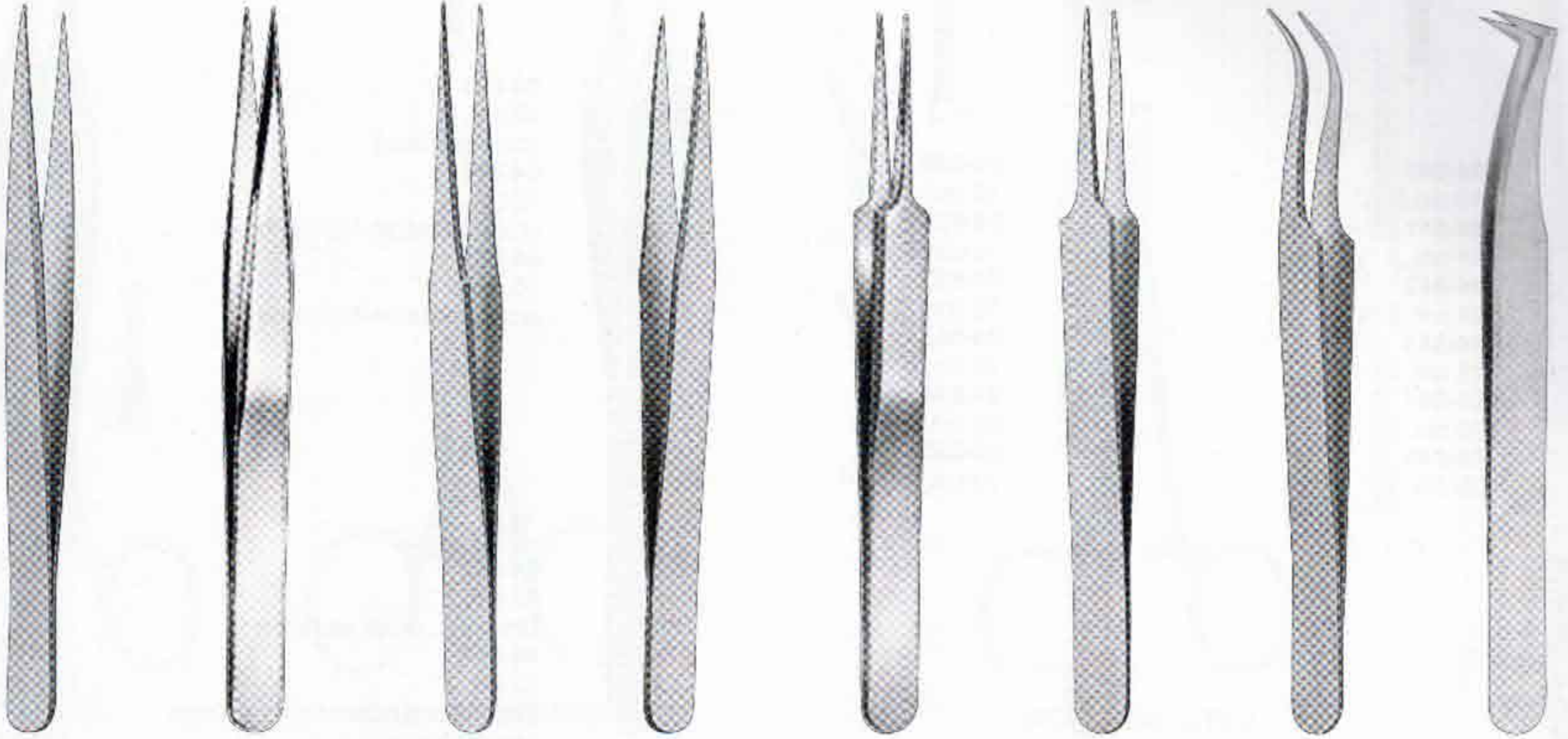

Jewelers Forceps   Jewelers Forceps   Jewelers Forceps   Jewelers Forceps   Jewelers Forceps   Jewelers Forceps   Jewelers Forceps   Jewelers Forceps

04-750   04-755   04-760   04-765   04-770   04-775   04-780   04-785

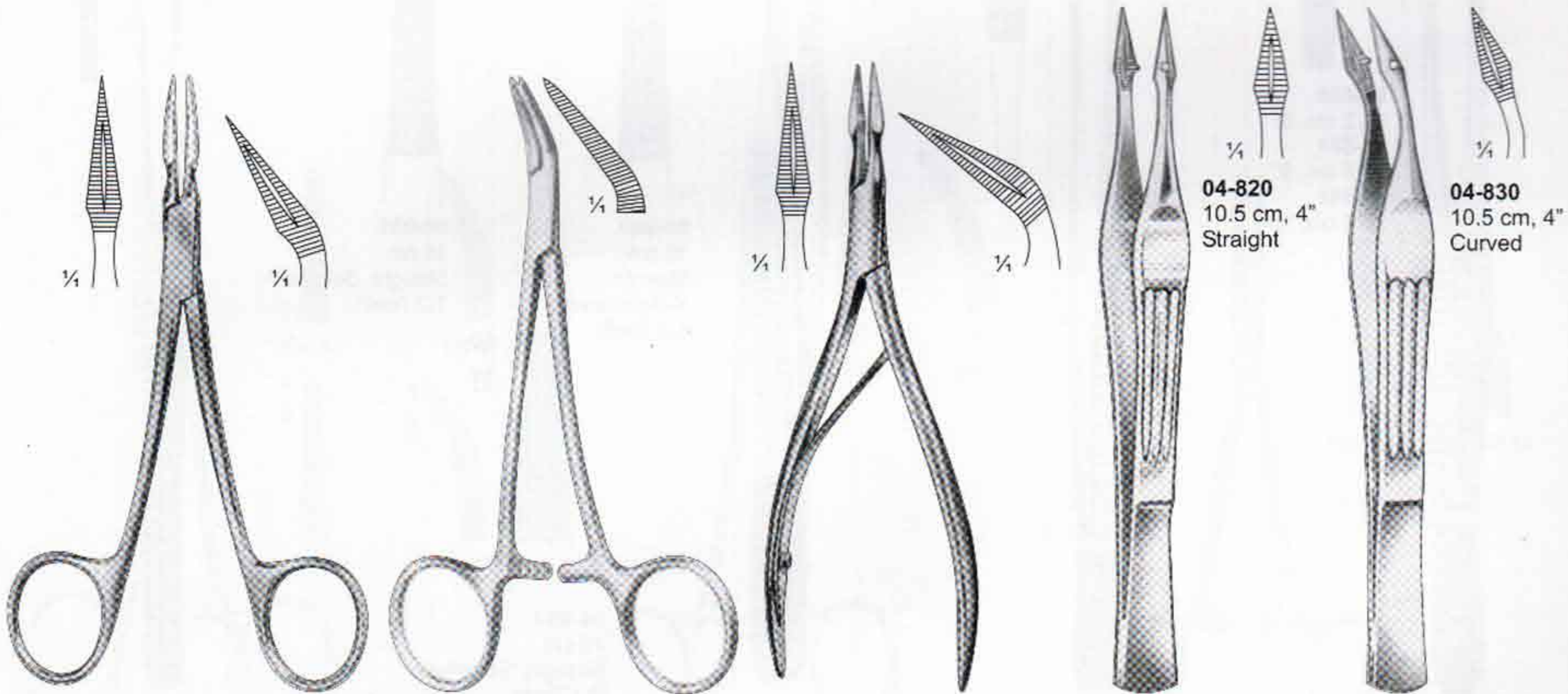

**STIEGLITZ**  
04-790 14 cm, 5 1/2" Str.  
04-791 14 cm, 5 1/2" Cvd.

**PEET**  
04-800  
11.5 cm, 4 1/2"

**RALK**  
04-810 15 cm, 6" Str.  
04-811 15 cm, 6" Cvd.

**CARMALT**

**CARMALT**

04-820  
10.5 cm, 4"  
Straight

04-830  
10.5 cm, 4"  
Curved



# TISSUE & DRESSING FORCEPS T.C

Pinces a tissu, Anatomische pinzetten  
Gewebe, Pinzas de disección

Pinzas para tejidos, Pinces à dissection  
Pinze per tessuti, Pinze per dissezione



- 04-840 13 cm, 5 1/4"
- 04-841 14 cm, 5 1/2"
- 04-842 16 cm, 6 1/4"
- 04-843 18 cm, 7"
- 04-844 20 cm, 8"
- 04-845 25 cm, 10"

**STANDARD**



- 04-850 14 cm, 5 1/2"
- 04-851 16 cm, 6 1/4"
- 04-852 18 cm, 7"
- 04-853 20 cm, 8"
- 04-854 25 cm, 20"
- 04-855 30 cm, 12"

**STANDARD**



- 04-860 12 cm, 5" cross serration
- 04-861 12 cm, 5" cross serration-1:2 Teeth
- 04-862 15.0 cm, 6" cross serration-1:2 Teeth



- 04-863 12 cm, 5" Dressing, cross serration
- 04-864 12 cm, 5" Tissue, cross serration-1:2 Teeth

**ADSON**



**ADSON**  
04-870 12 cm, 5"



- 04-880 15.2 cm, 6"
- 04-881 22.9 cm, 9"
- 04-882 25.4 cm, 10"

**WANGENSTEEN**  
TISSUE FORCEPS



- 04-890 15 cm, 6"
- 04-891 23 cm, 9"
- 04-892 25 cm, 10"

**WANGENSTEEN**



**BONNEY**  
DISSECTING

- 04-900 18 cm Straight X-Serrations 1:2 Teeth

- 04-901 18 cm Straight, Serrated-1:2 Teeth

- 04-902 18 cm Straight, Serrated-2:3 Teeth



- 04-910 15 cm, 6"
- 04-911 18 cm, 7"
- 04-912 20 cm, 8"
- 04-913 23 cm, 9"
- 04-914 25 cm, 10"

**POTTS-SMITH**  
FORCEPS



# HAEMOSTATIC FORCEPS

Arterienklemmen  
Pinzas hemostaticas

Pinces hemostatiques  
Pinze emostatiche

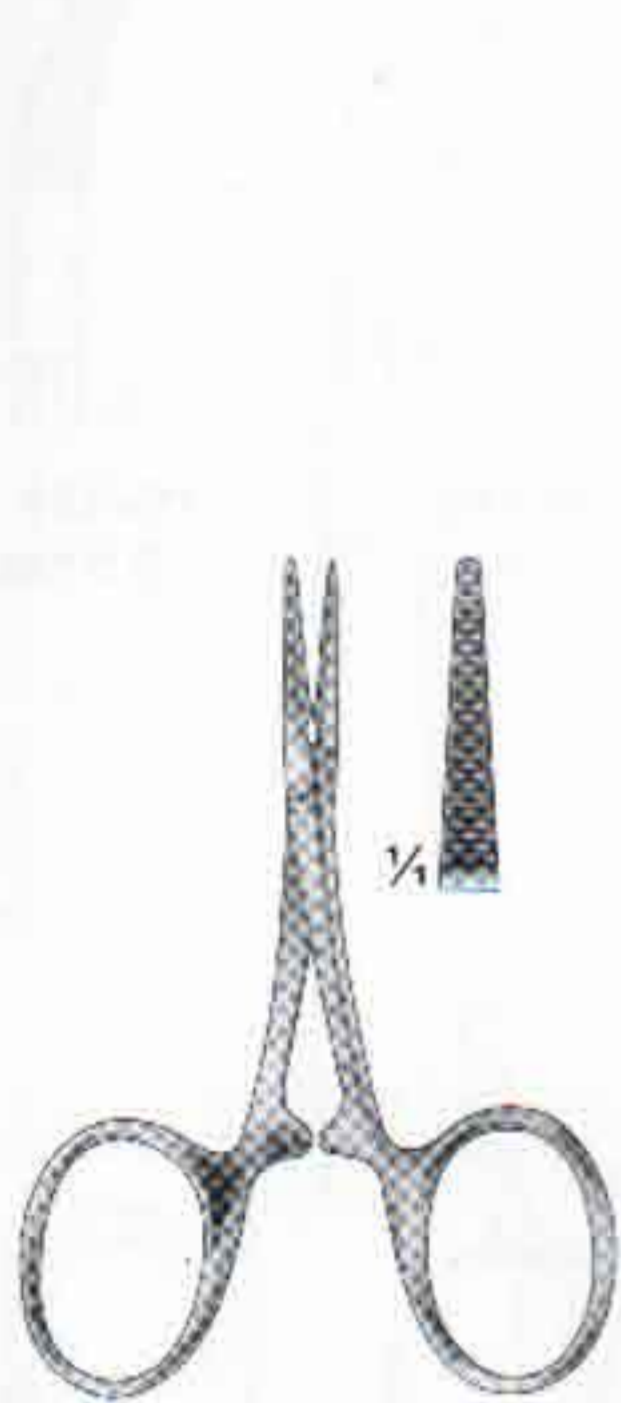

**CARREL**  
05-100  
8.5 cm, 3 1/4"

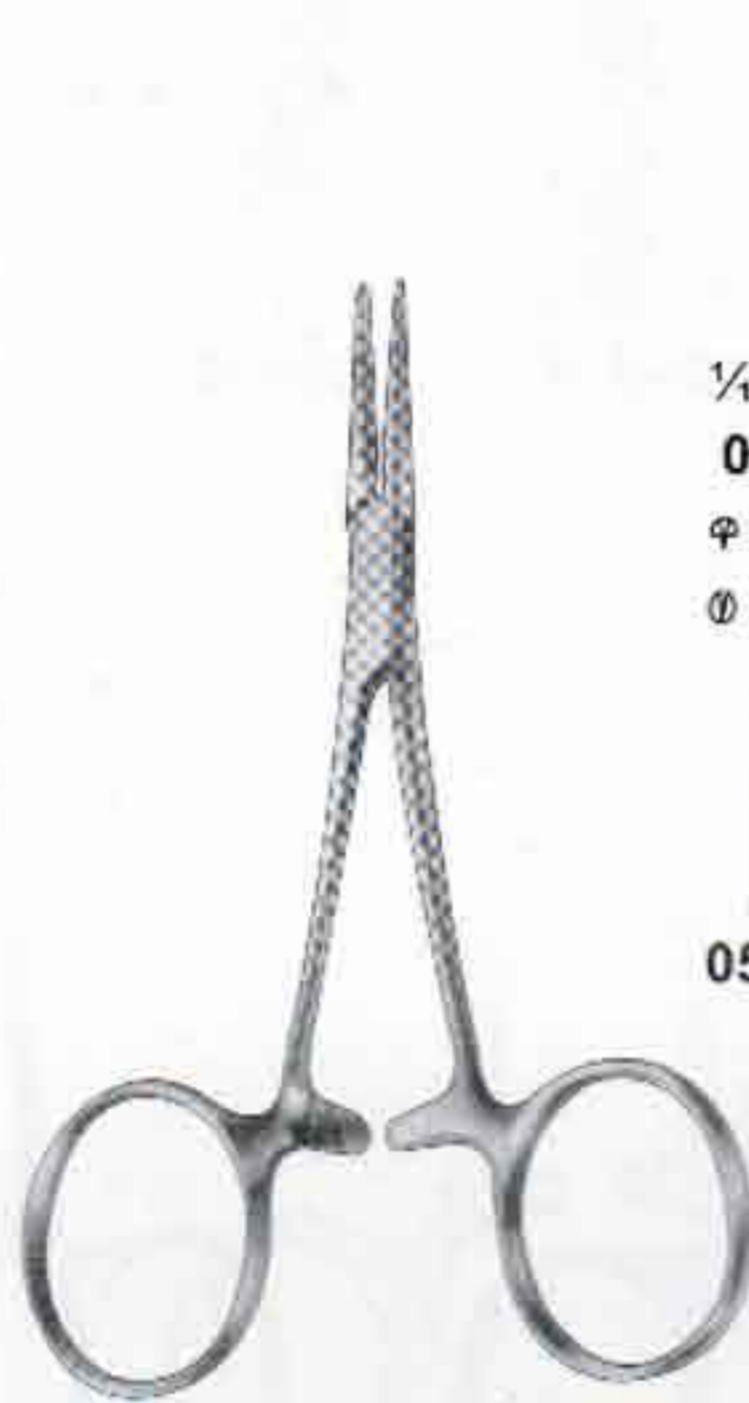

**BABY-MOSQUITO  
(HARTMANN)**  
05-110  
10.0 cm, 4"

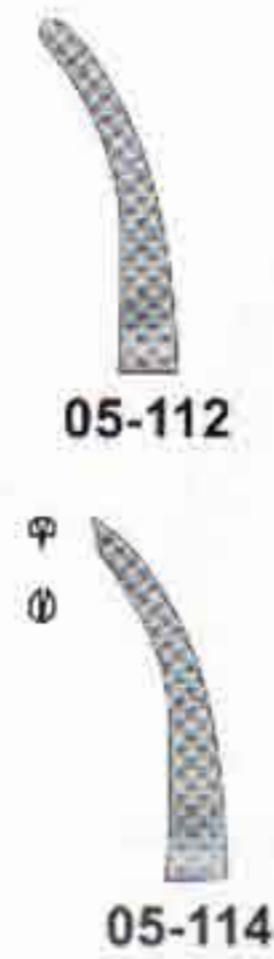

**MICRO-HALSTED**  
05-120  
12.5 cm, 5"

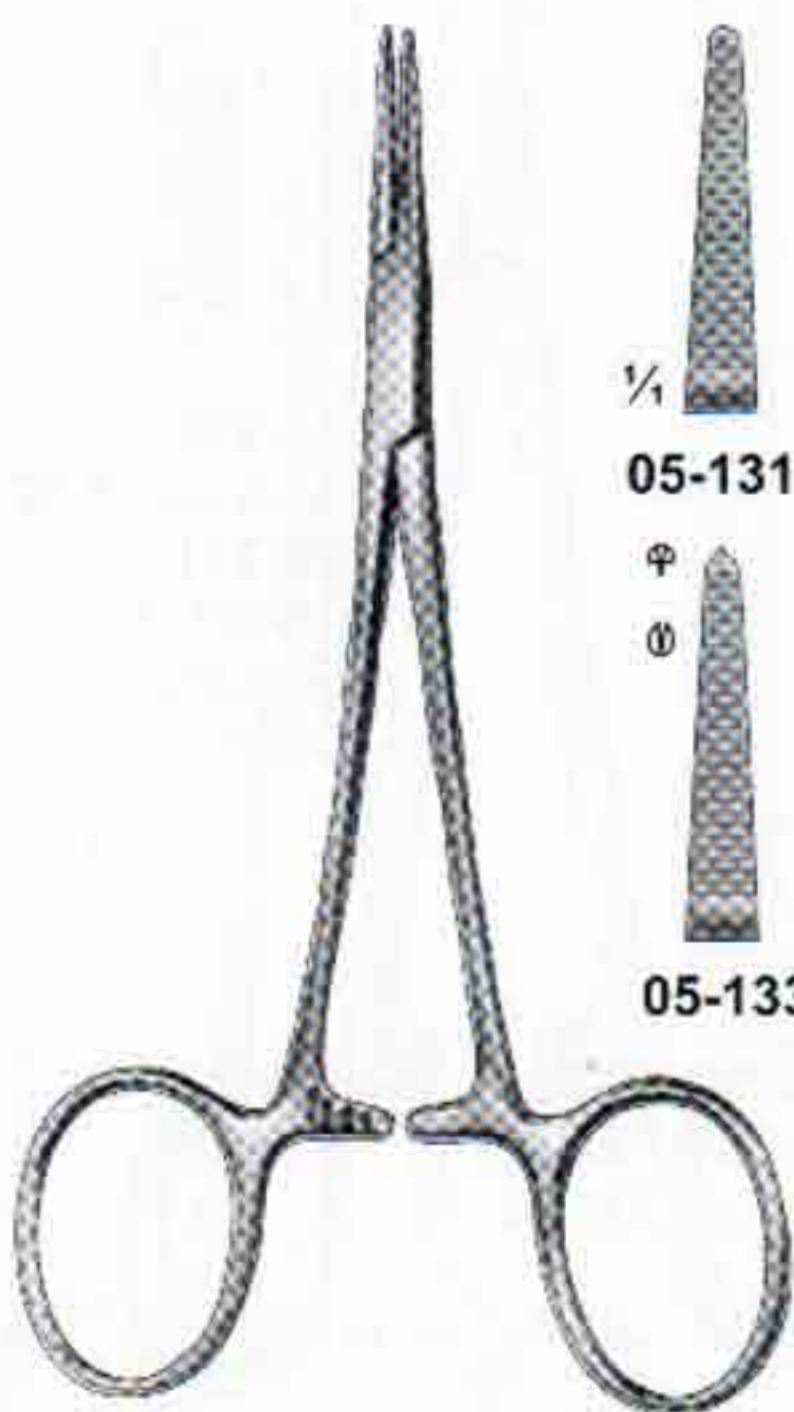
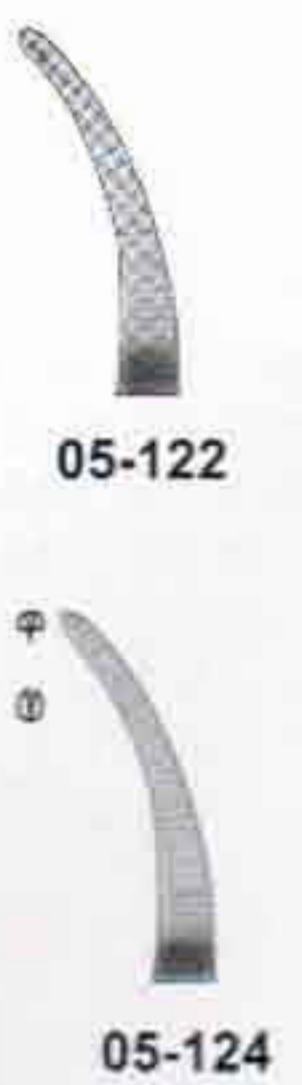

**HALSTED-MOSQUITO**  
05-130  
12.5 cm, 5"

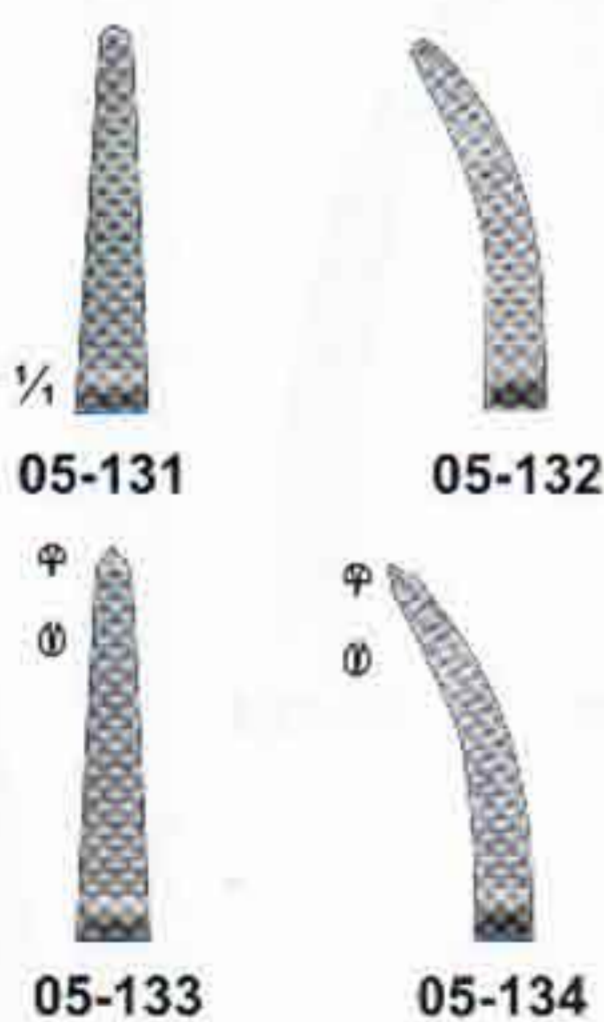

**PROVIDENCE-HOSPITAL**  
05-140  
14.0 cm, 5 1/2"

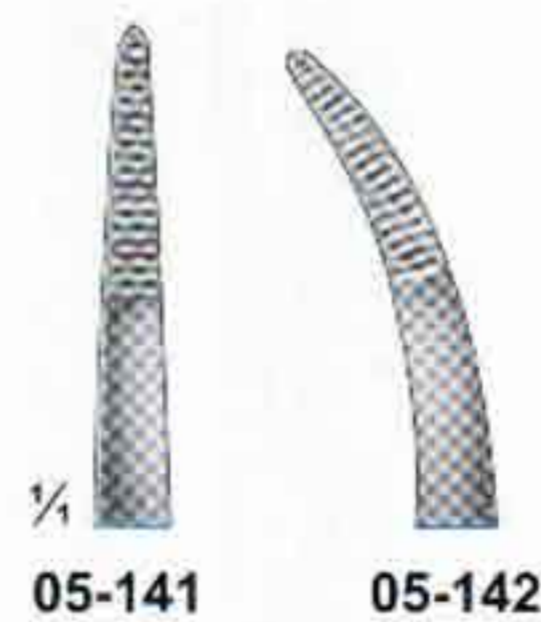

**KELLY**  
05-150  
14.0 cm, 5 1/2"

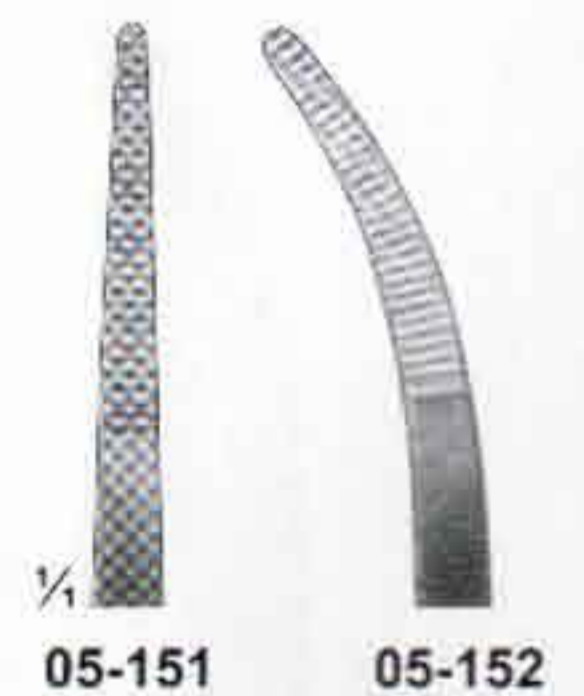



# HAEMOSTATIC FORCEPS

Arterienklemmen  
Pinzas hemostaticas

Pinces hemostatiques  
Pinze emostatiche

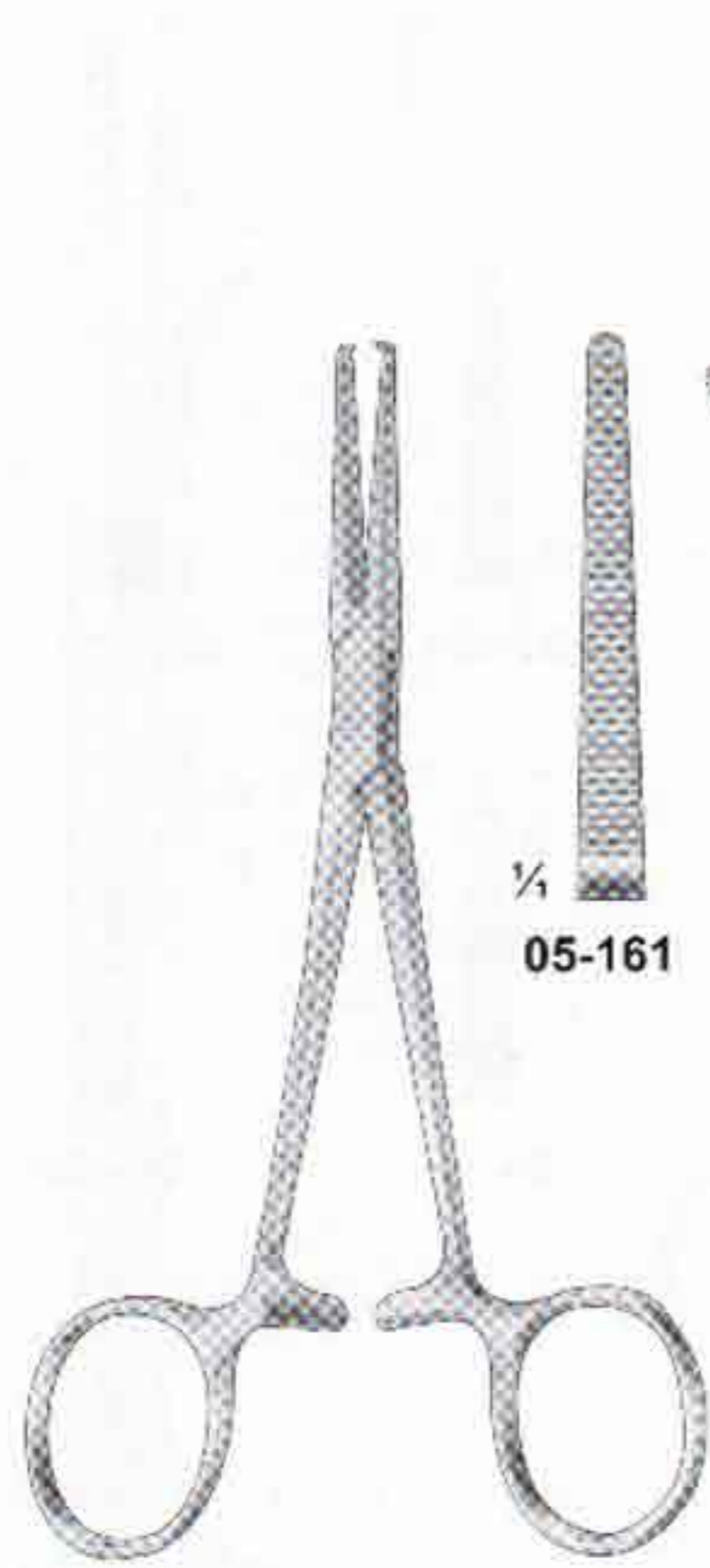

**CRILE**  
05-160  
14.0 cm, 5 1/2"



05-161



05-162



05-163



05-164

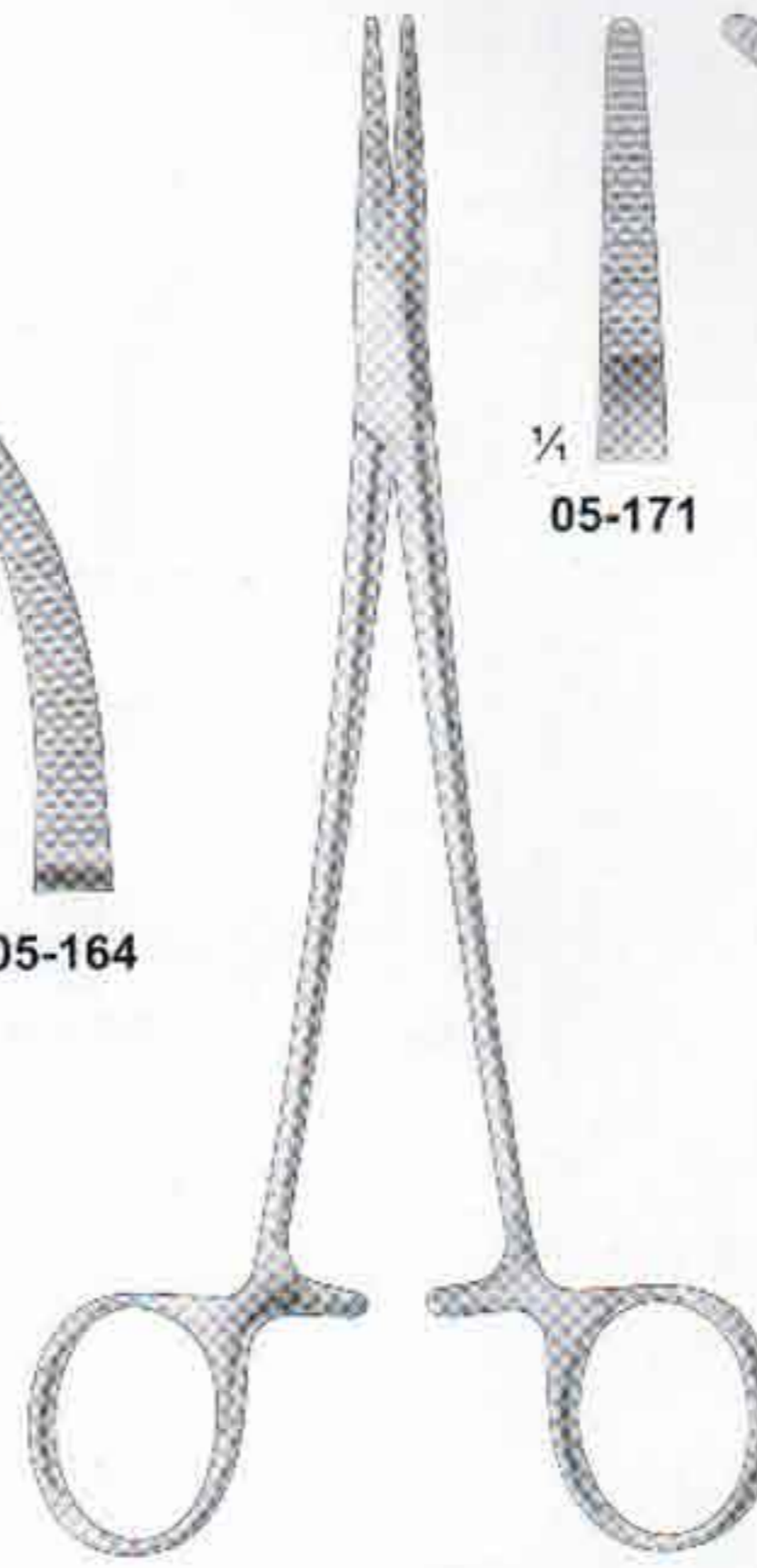

**ADSON**  
05-170  
18.5 cm, 7 1/4"



05-171



05-172

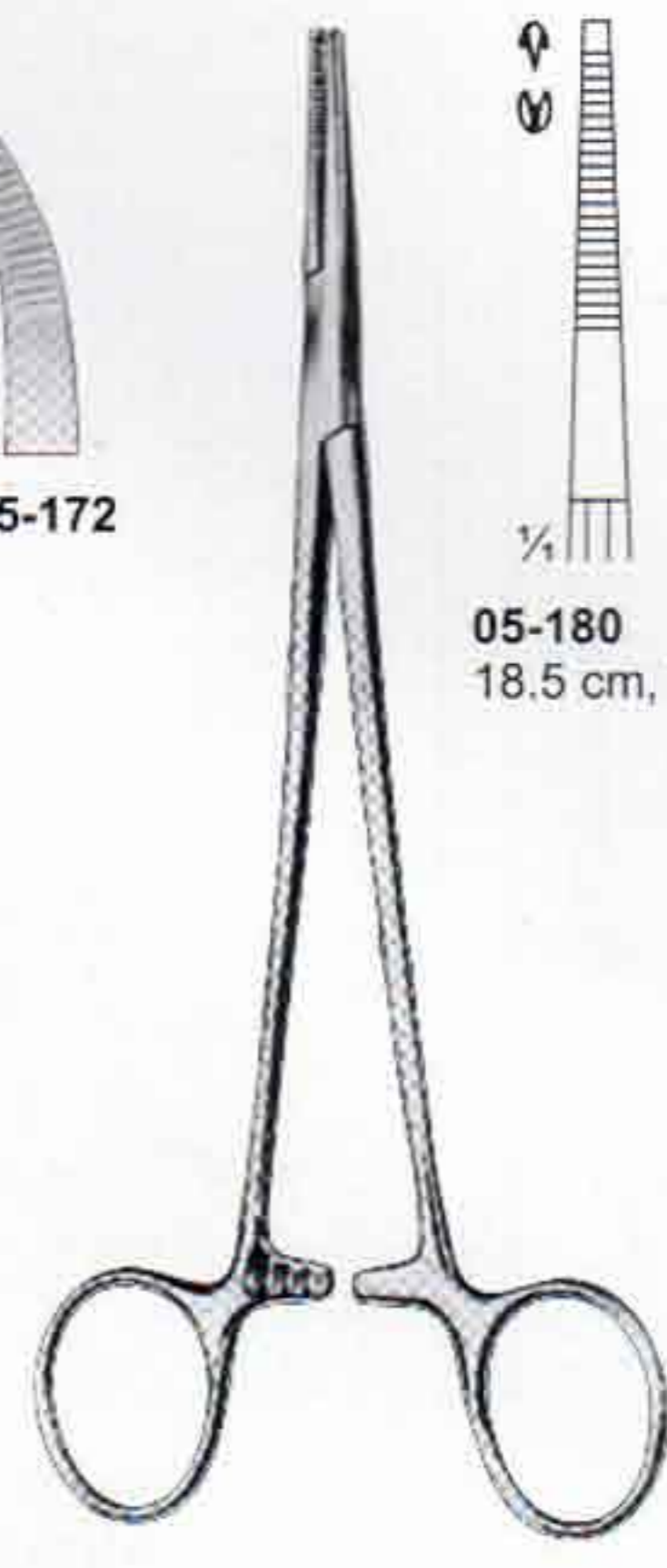

**ADSON 1:2**



05-180  
18.5 cm, 7 1/4"

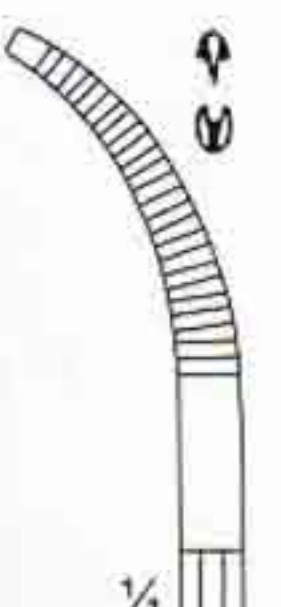

05-181  
18.5 cm, 7 1/4"

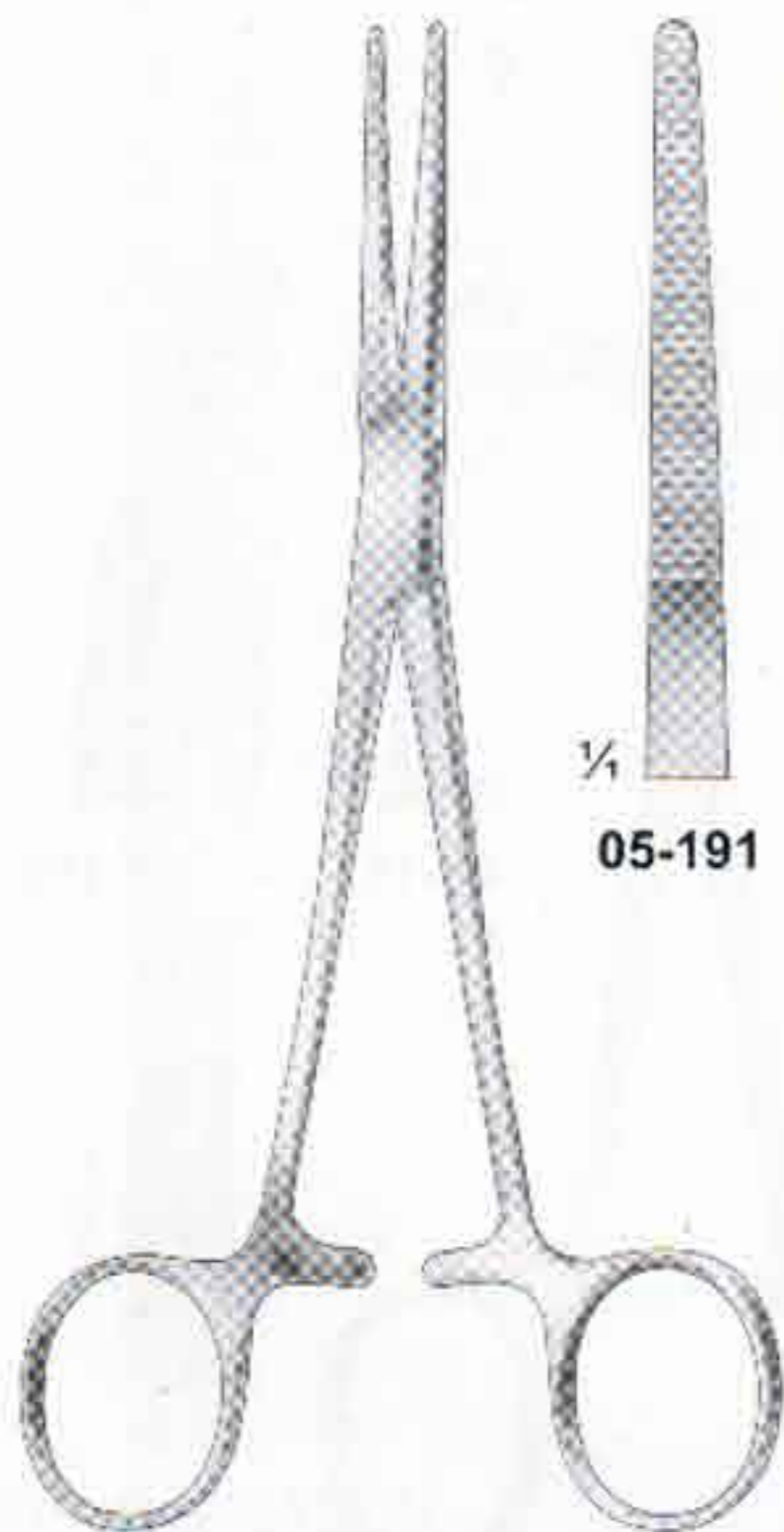

**RANKIN**  
05-190  
16.0 cm, 6 1/4"



05-191



05-192

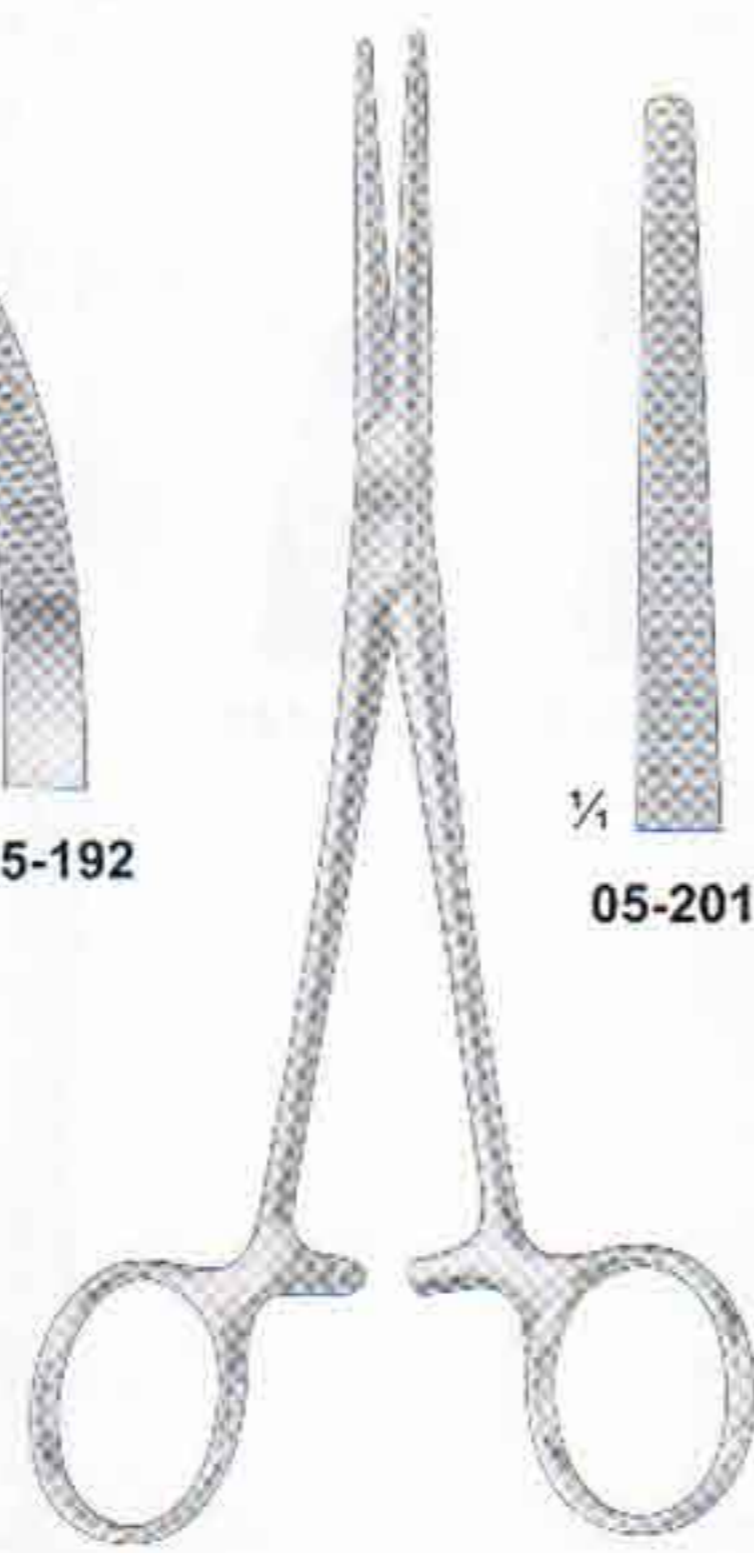

**RANKIN**  
05-200  
16.0 cm



05-201

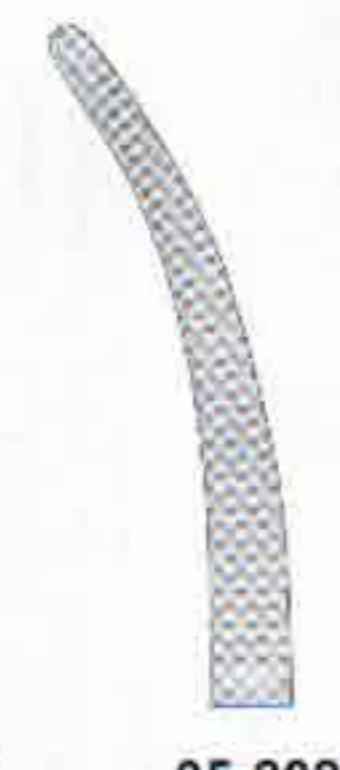

05-202



05-203



05-204

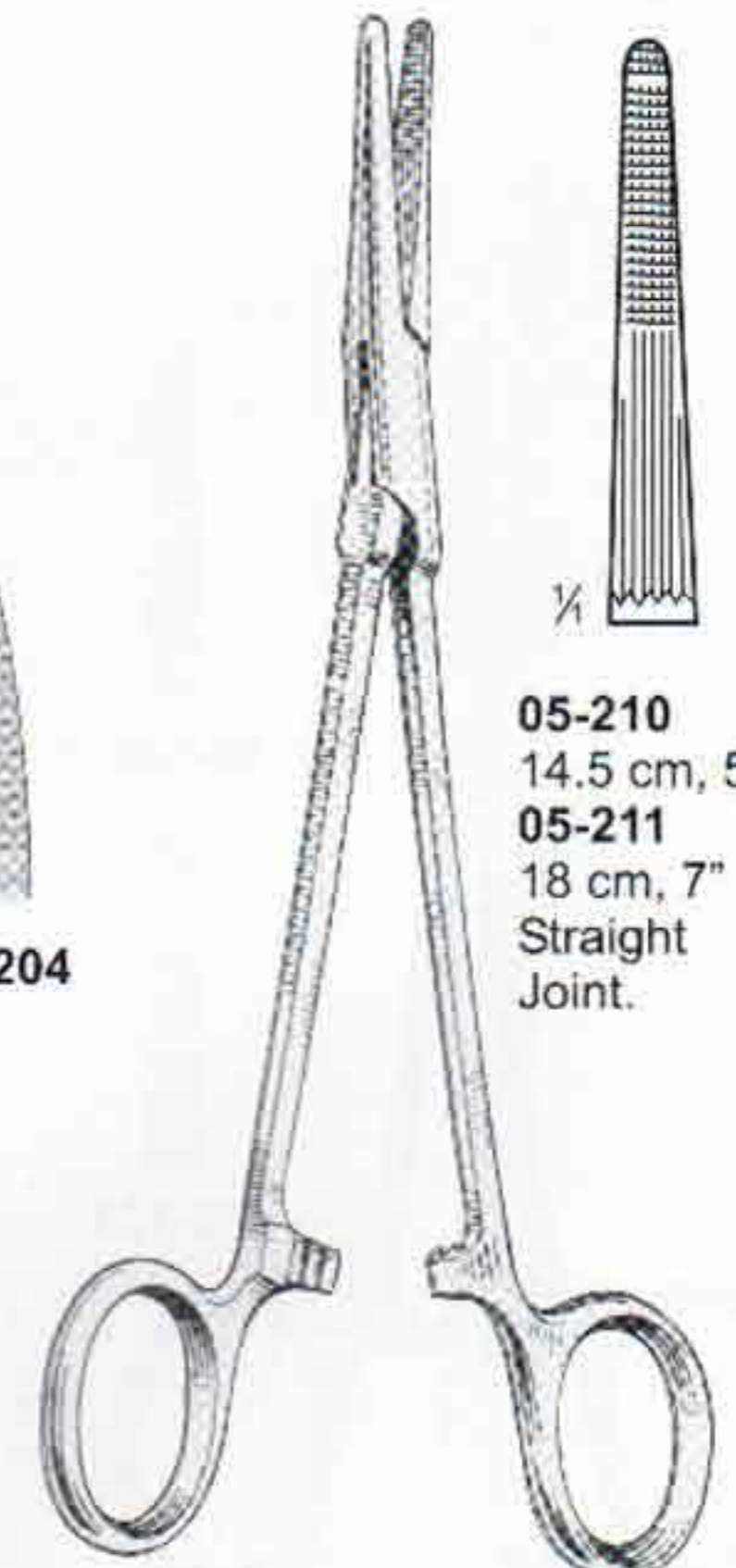

**GREY TURNER**



05-210  
14.5 cm, 5 3/4"  
05-211  
18 cm, 7"  
Straight  
Joint.



# HAEMOSTATIC FORCEPS

Arterienklemmen  
Pinzas hemostaticas

Pinces hemostatiques  
Pinze emostatiche

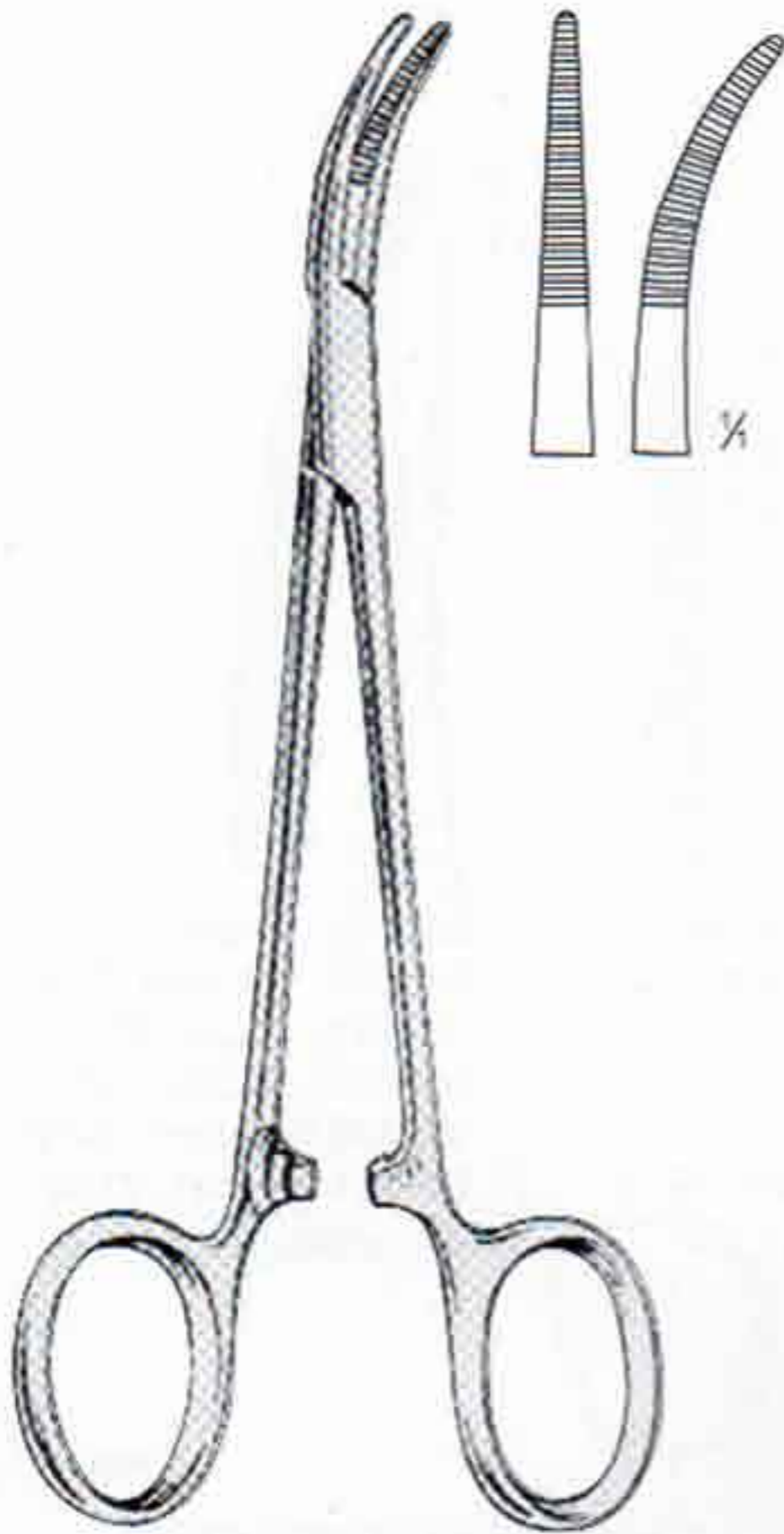

**CAIRNS**  
05-220  
14.5 cm, 5 3/4"  
Straight, box joint, as above but curved on flat.

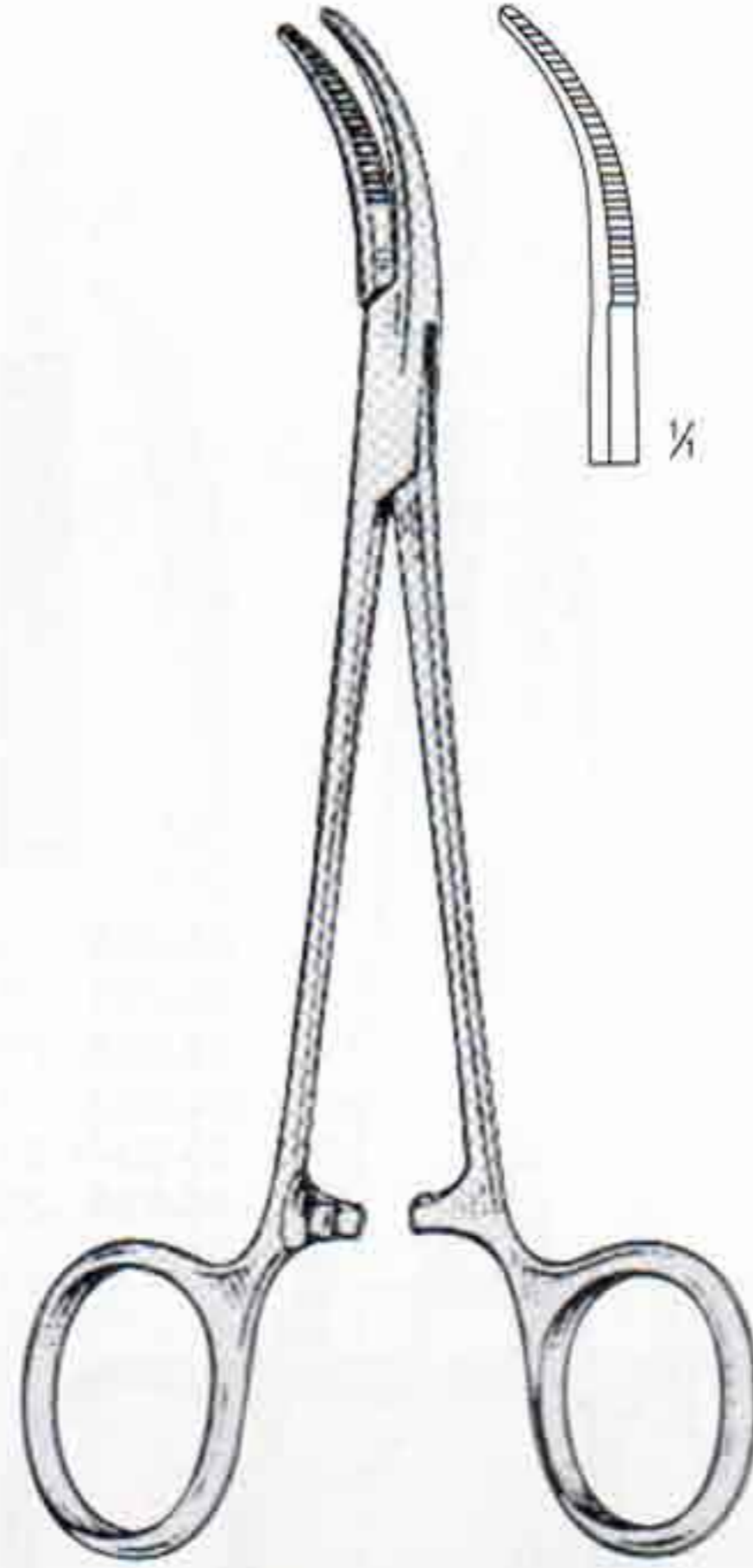

**CAIRNS**  
05-230  
14.5 cm, 5 3/4"  
curved laterally, joint



**SPENCER-WELLS**  
Slender Type

	1/4		
05-240	13.0 cm	05-244	13.0 cm
05-241	15.0 cm	05-245	15.0 cm
05-242	17.5 cm	05-246	17.5 cm
05-243	20 cm	05-247	20 cm

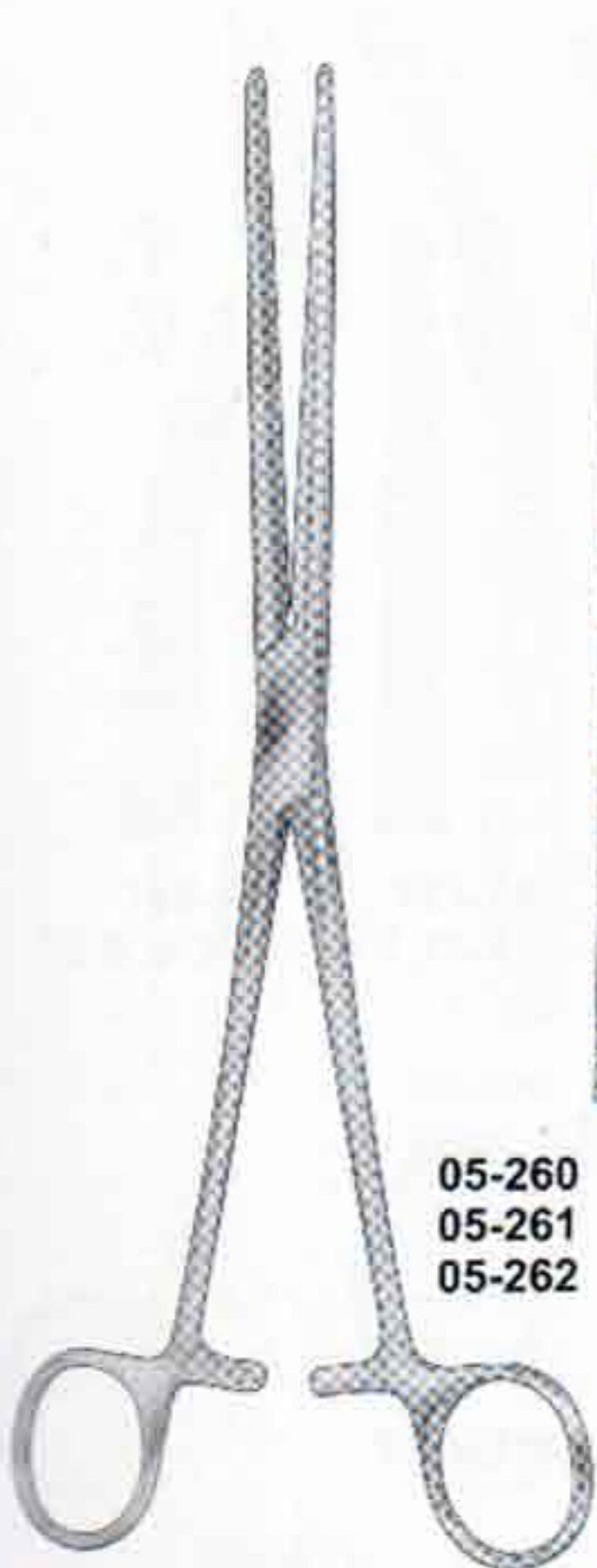

**PEAN**

05-260	24cm, 9 3/4"	05-263	24cm, 9 3/4"
05-261	26cm, 10 1/4"	05-264	26cm, 10 1/4"
05-262	28cm, 11"	05-265	28cm, 11"

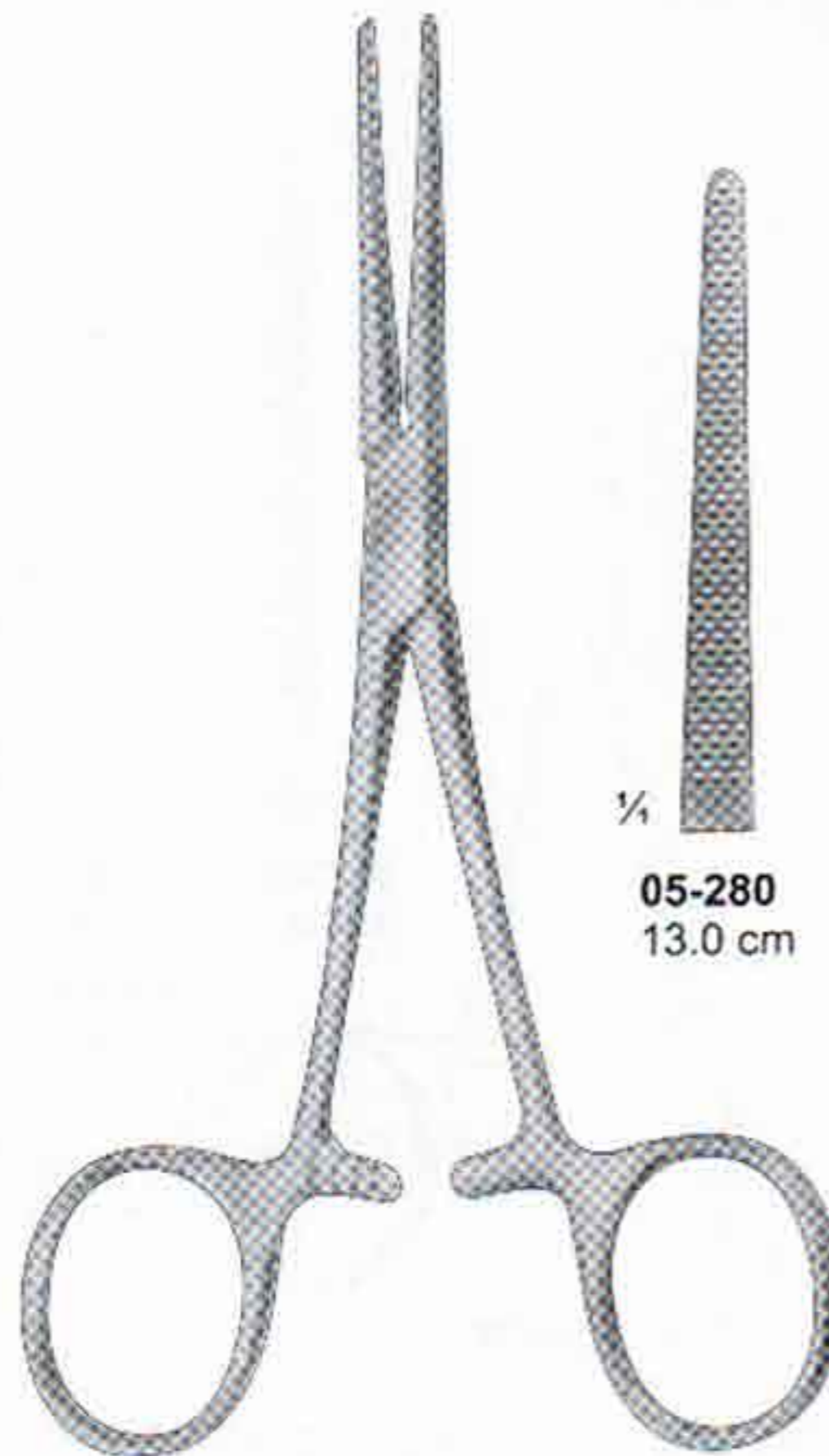

**PEAN**  
Slender Type

	1/4				
05-280	13.0 cm	05-281	14.0 cm	05-282	13.0 cm
				05-283	14.0 cm



# HAEMOSTATIC FORCEPS

Arterienklemmen  
Pinzas hemostaticas

Pinces hemostatiques  
Pinze emostatiche

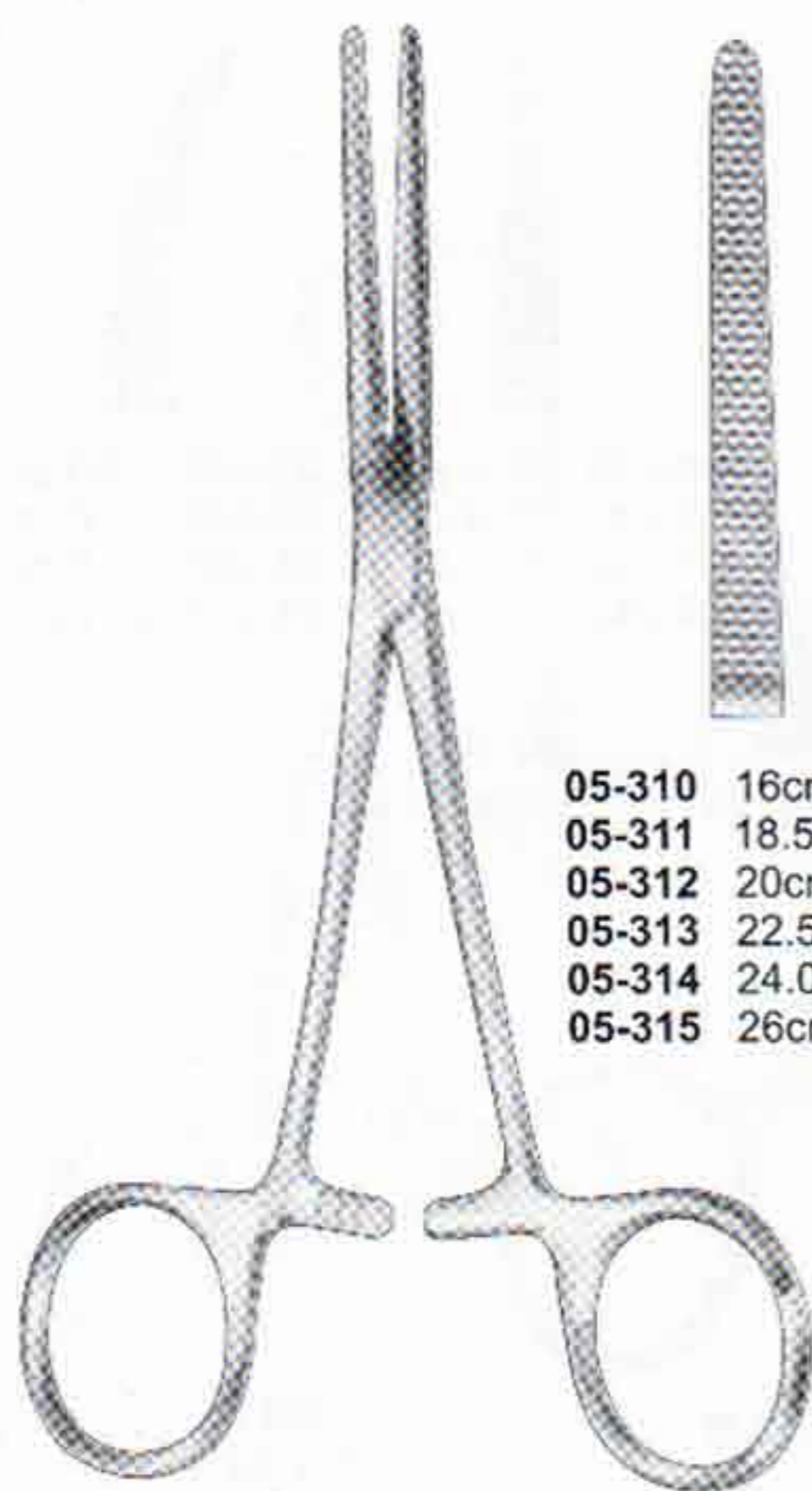

**ROCHESTER-PEAN**

05-310 16cm, 6 1/4"  
05-311 18.5cm, 7 1/4"  
05-312 20cm, 8"  
05-313 22.5cm, 9"  
05-314 24.0cm, 9 3/4"  
05-315 26cm, 10 1/4"

05-316 16cm, 6 1/4"  
05-317 18.5cm, 7 1/4"  
05-318 20cm, 8"  
05-319 22.5cm, 9"  
05-320 24.0cm, 9 3/4"  
05-321 26cm, 10 1/4"

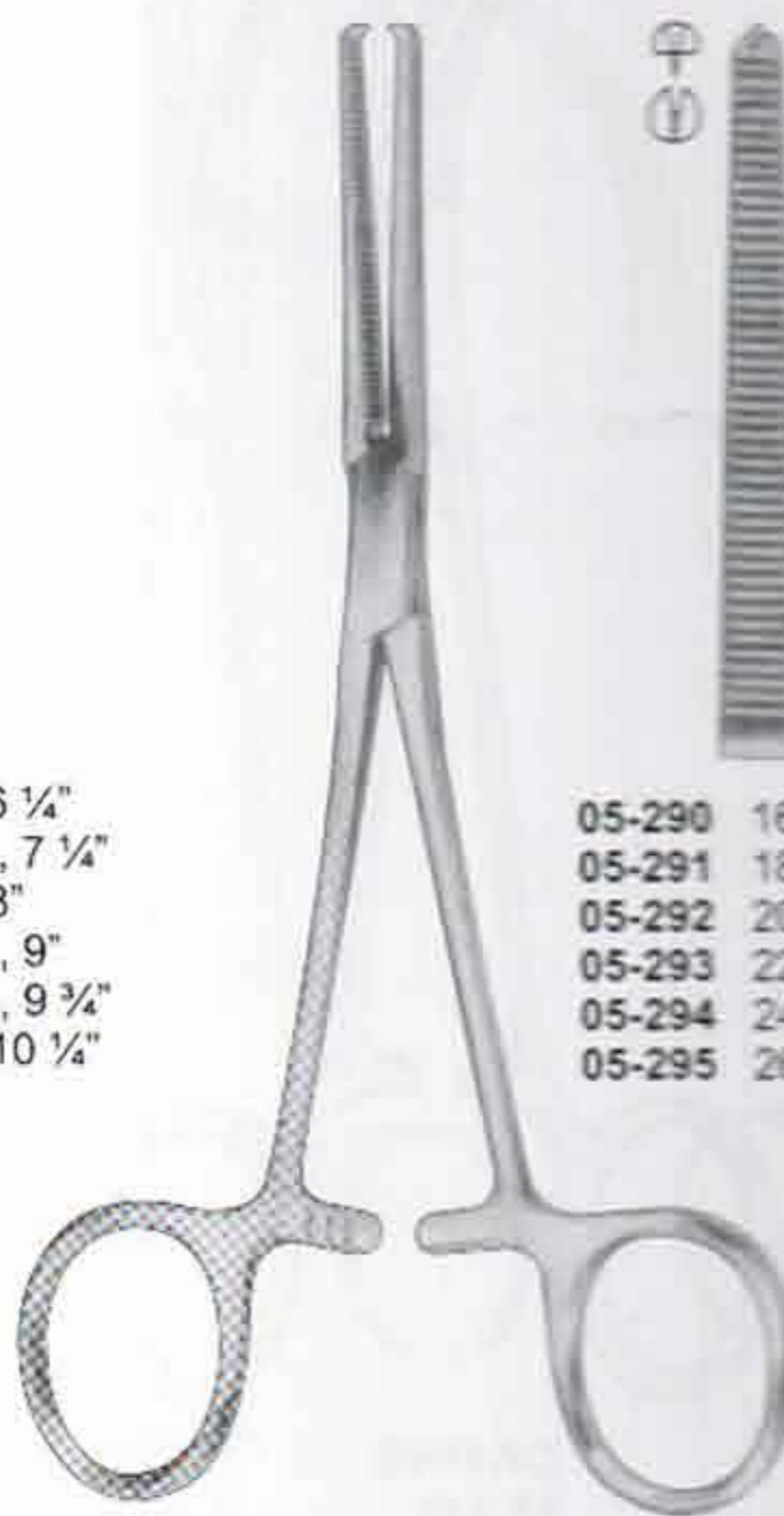

**KOCHER-OCHSNER**

05-290 16cm, 6 1/4"  
05-291 18.5cm, 7 1/4"  
05-292 20cm, 8"  
05-293 22.5cm, 9"  
05-294 24.0cm, 9 3/4"  
05-295 26cm, 10 1/4"

05-296 16cm, 6 1/4"  
05-297 18.5cm, 7 1/4"  
05-298 20cm, 8"  
05-299 22.5cm, 9"  
05-300 24.0cm, 9 3/4"  
05-301 26cm, 10 1/4"

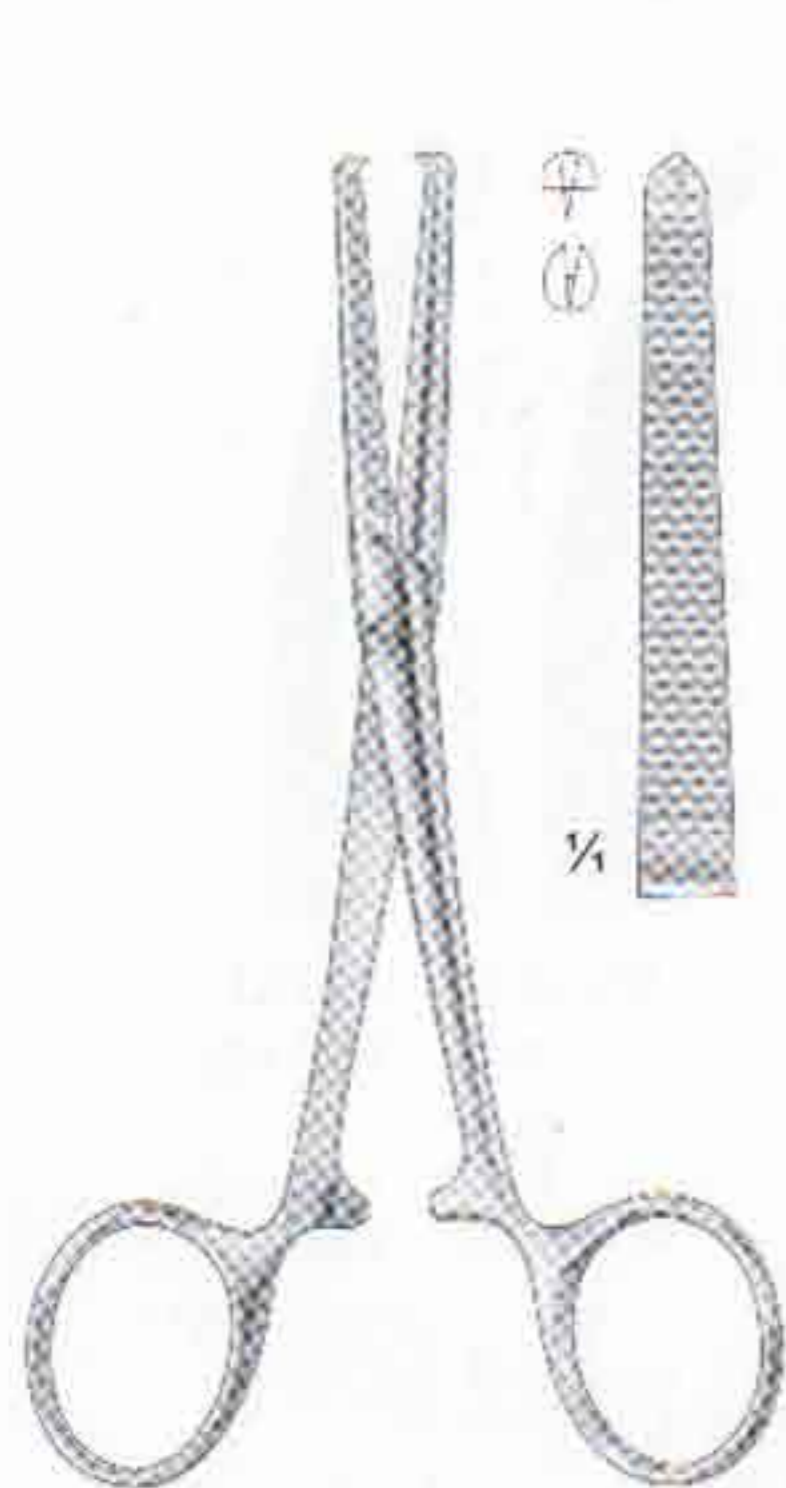

**KOCHER**  
Strong Pattern  
05-330  
14.5cm, 5 3/4"

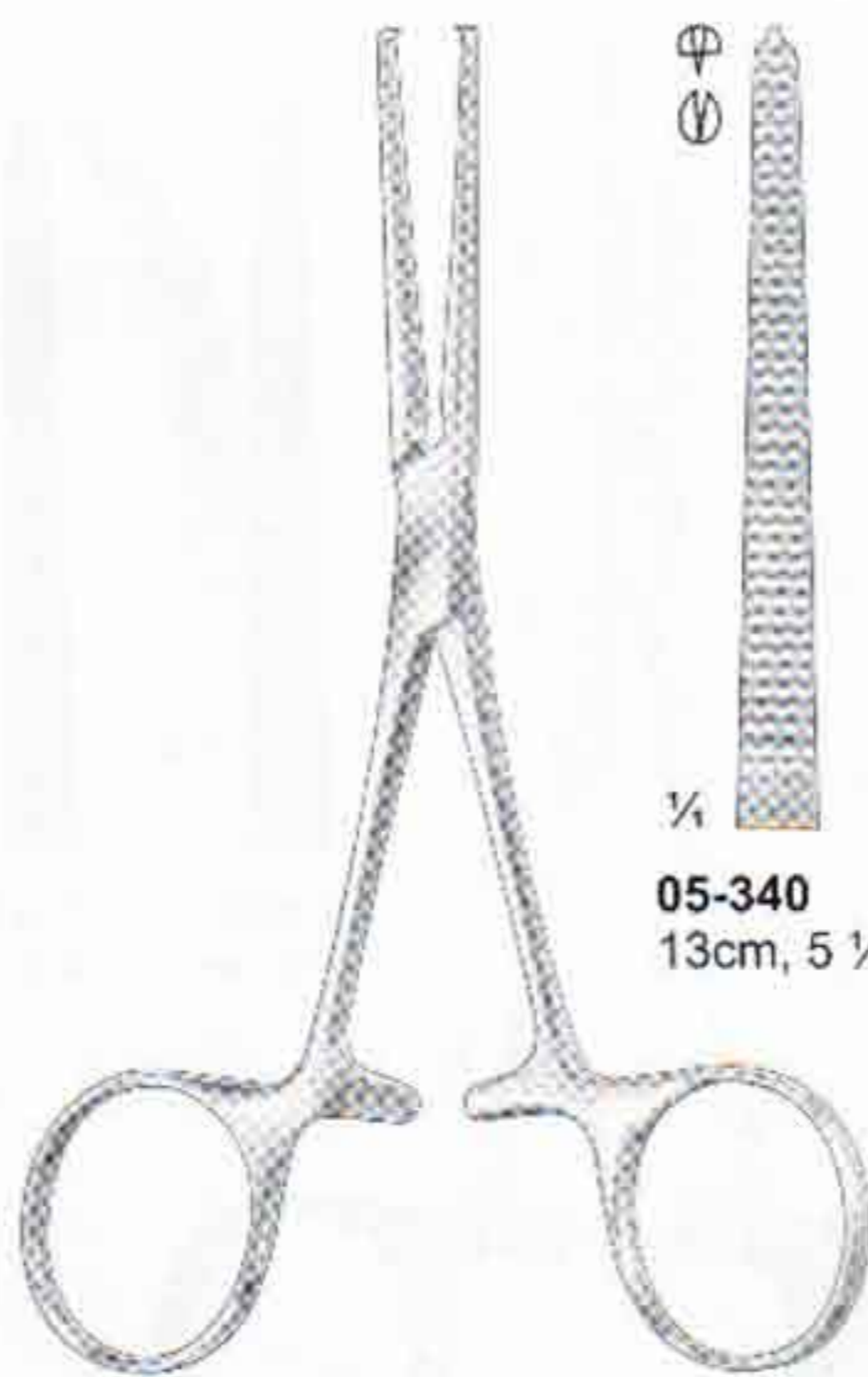

**KOCHER**

05-340  
13cm, 5 1/4"

05-341  
14cm, 5 1/2"

05-342  
14cm, 5 1/2"



**ROCHESTER-OCHSNER**

05-350  
14cm, 5 1/2"

05-351  
14cm, 5 1/2"



# HAEMOSTATIC FORCEPS

Arterienklemmen  
Pinzas hemostaticas

Pinces hemostatiques  
Pinze emostatiche

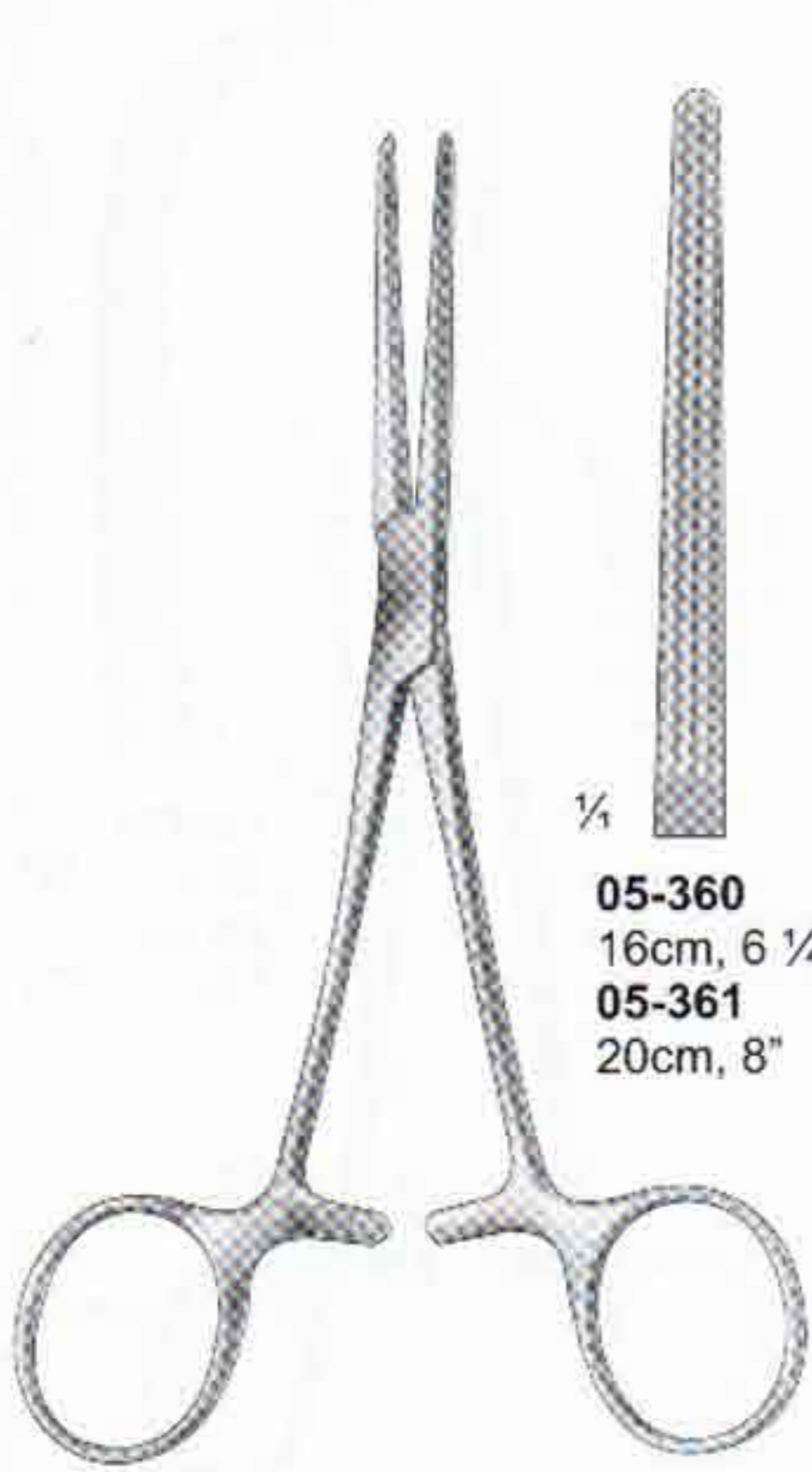

1/4  
**05-360**  
16cm, 6 1/4"  
**05-361**  
20cm, 8"



**05-362**  
16cm, 6 1/4"  
**05-363**  
20cm, 8"

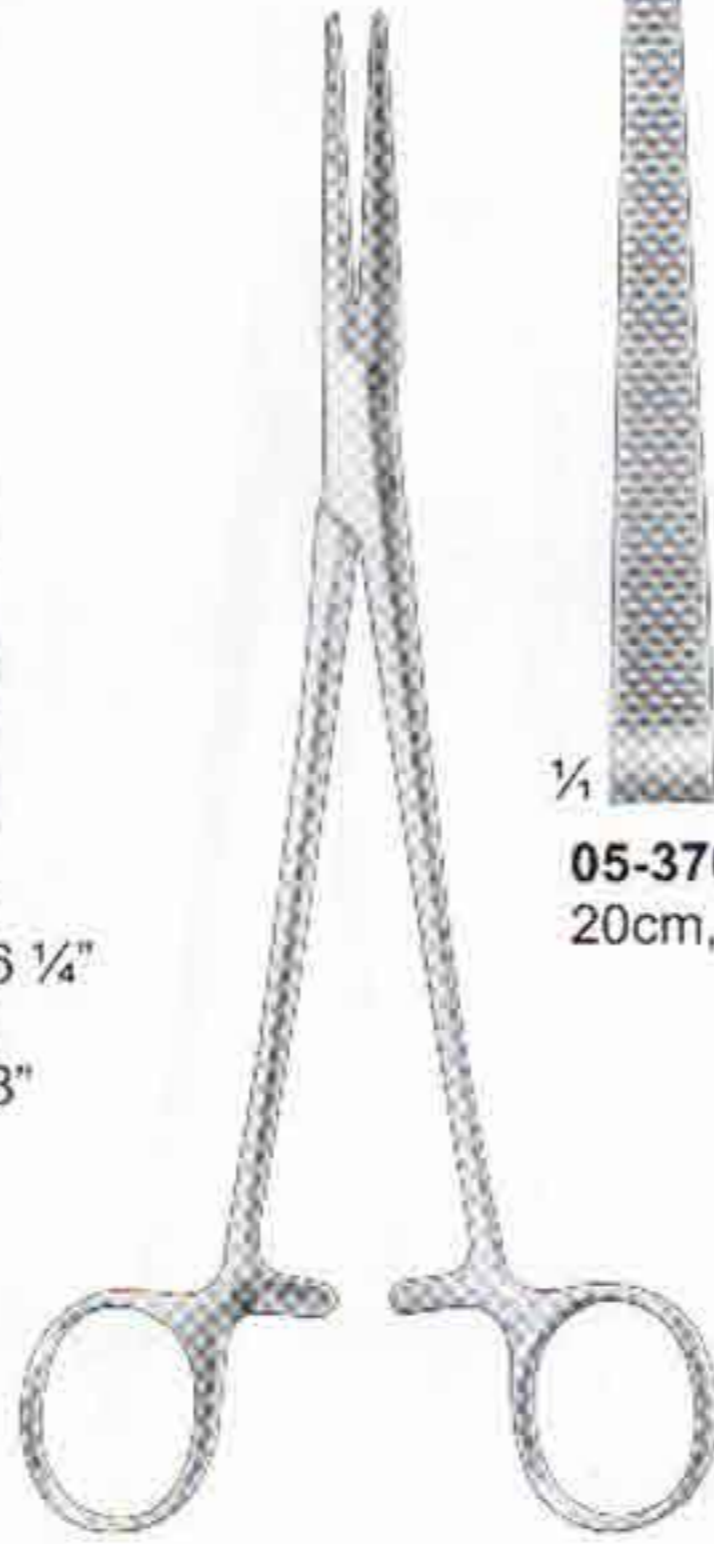

1/4  
**05-370**  
20cm, 8"



**05-371**  
20cm, 8"



**05-372**  
20cm, 8"

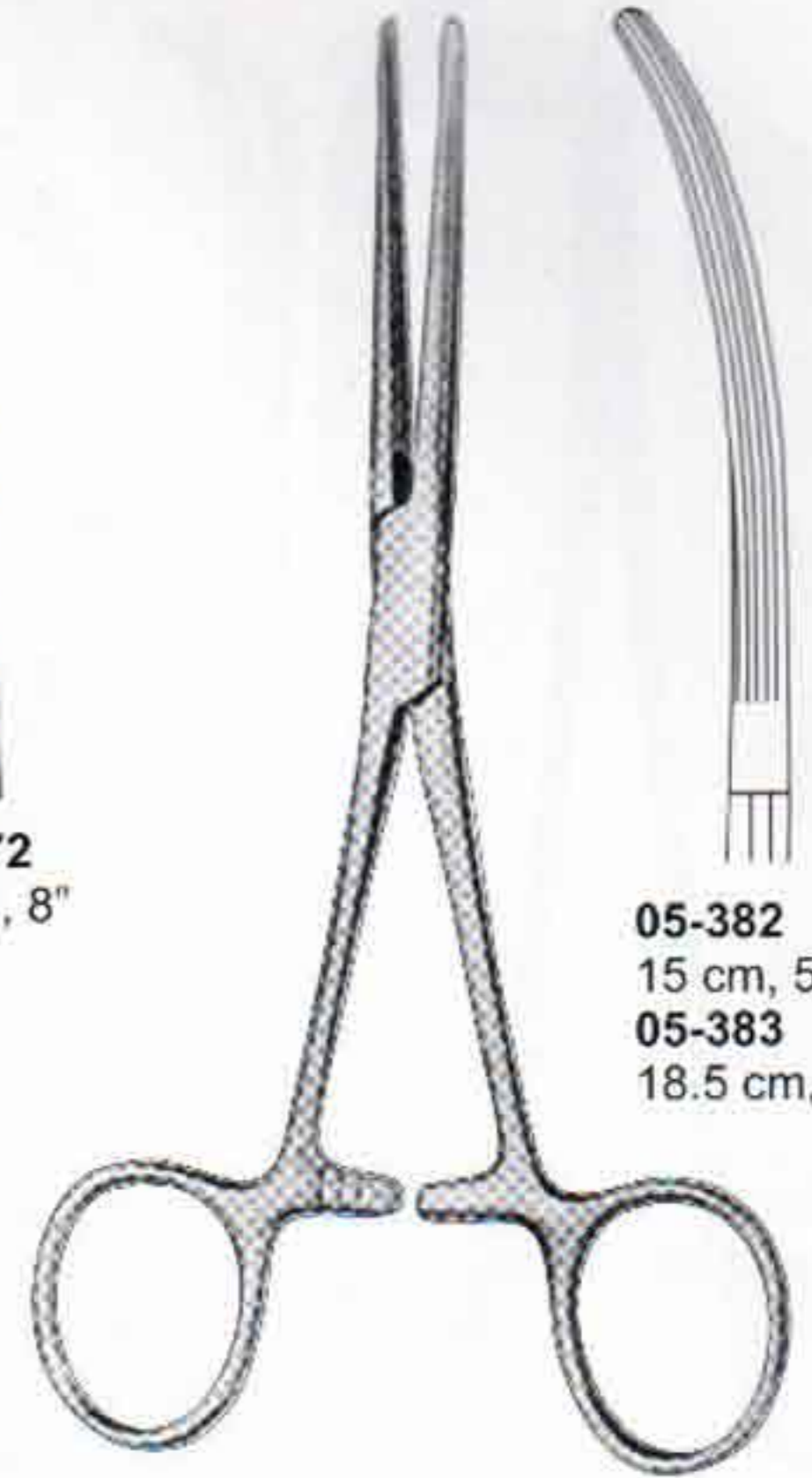

**05-382**  
15 cm, 5 3/4"  
**05-383**  
18.5 cm, 7 1/4"

**ROCHESTER-CARMALT**

**HEISS**

**BAINBRIDGE**

**05-380** 15 cm, 5 3/4"  
**05-381** 18.5 cm, 7 1/4"

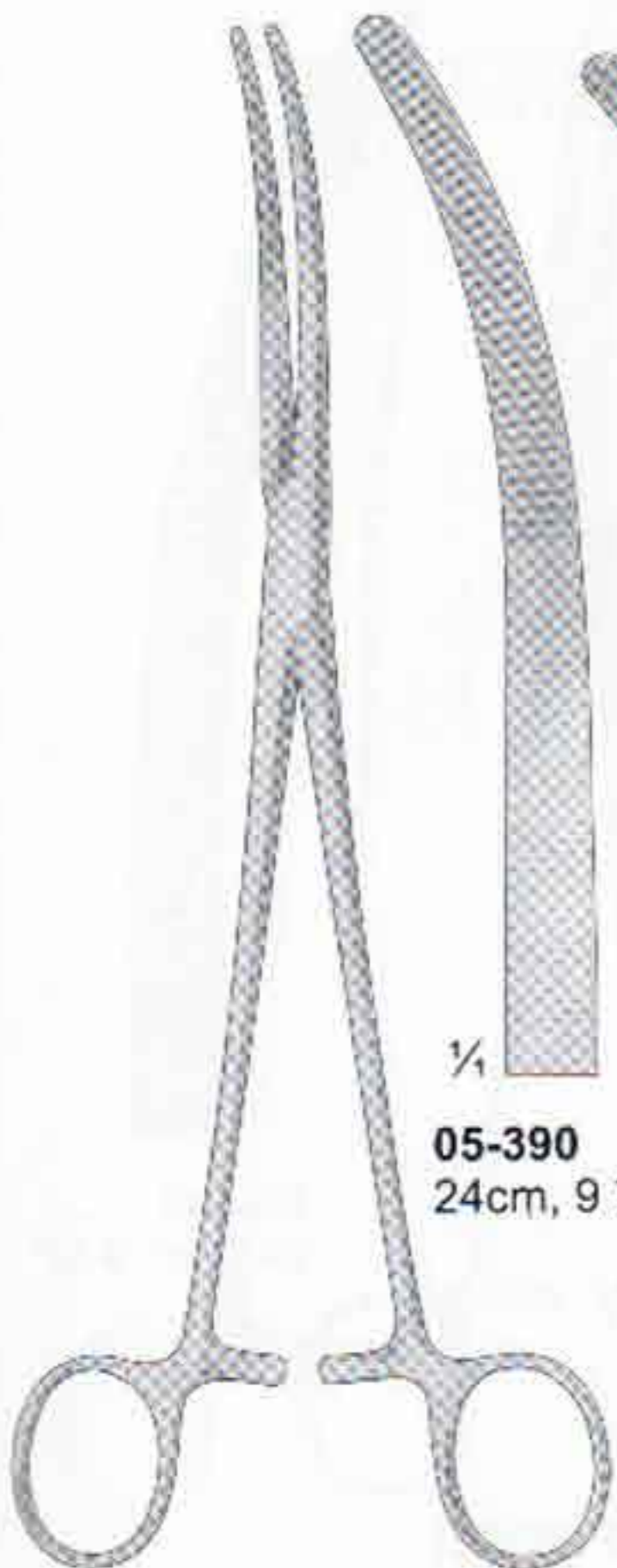

1/4  
**05-390**  
24cm, 9 1/2"



**05-391**  
24cm, 9 1/2"



**05-392**  
24cm, 9 1/2"



**05-393**  
24cm, 9 1/2"



**05-394**  
24cm, 9 1/2"

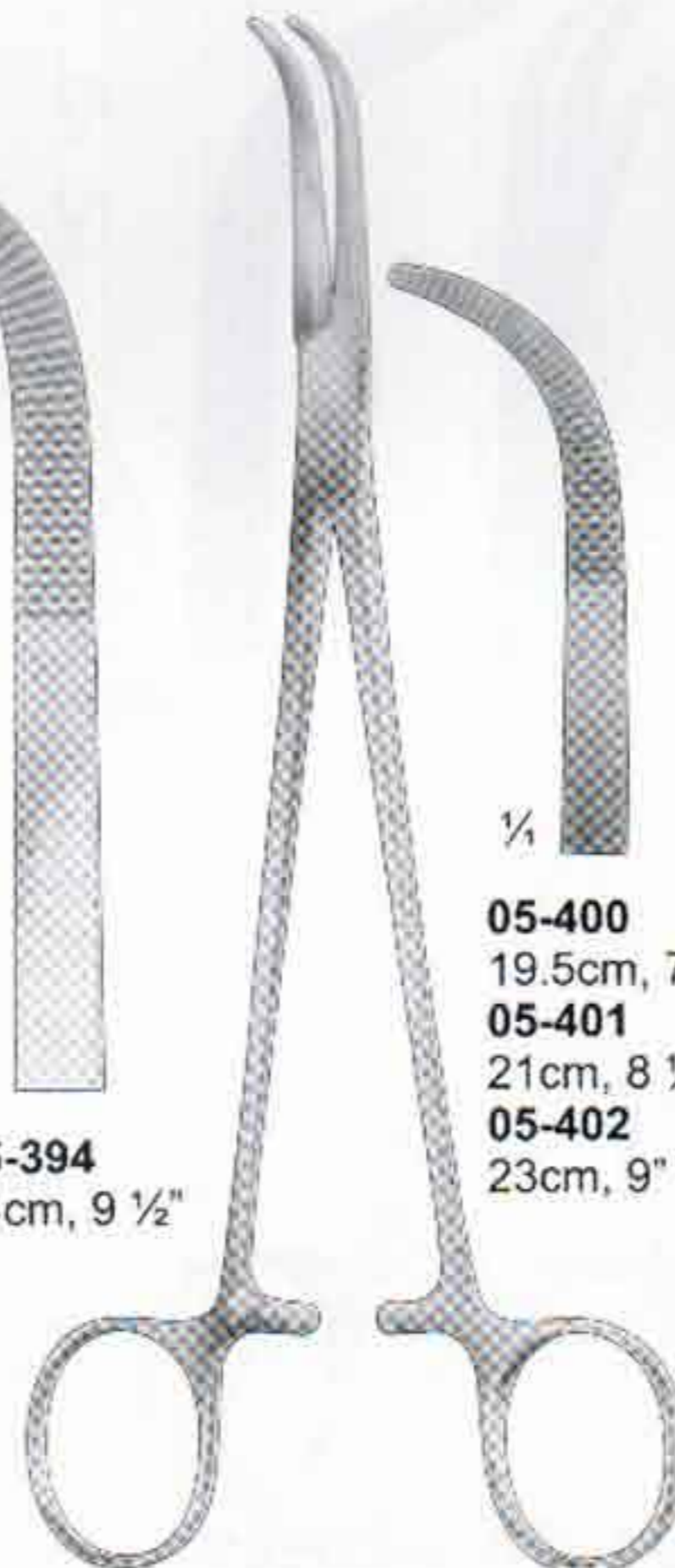

1/4  
**05-400**  
19.5cm, 7 3/4"  
**05-401**  
21cm, 8 1/4"  
**05-402**  
23cm, 9"



**05-403**  
21cm, 8 1/4"  
**05-404**  
22cm, 8 3/4"



**05-405**  
22.5cm, 9"



**05-406**  
22.5cm, 9"  
**05-407**  
26cm, 10 1/4"  
**05-408**  
27cm, 10 3/4"  
**05-409**  
27.5cm, 10 3/4"  
**05-410**  
27cm, 10 3/4"  
**05-411**  
28cm, 11"

**RUMEL**

**OVERHOLT-GEISSENDOERFER**



# HAEMOSTATIC FORCEPS

Arterienklemmen  
Pinzas hemostaticas

Pinces hemostatiques  
Pinze emostatiche



**MIXTER**  
05-420  
23cm, 9"



05-430  
18cm, 7"

**LOWER**

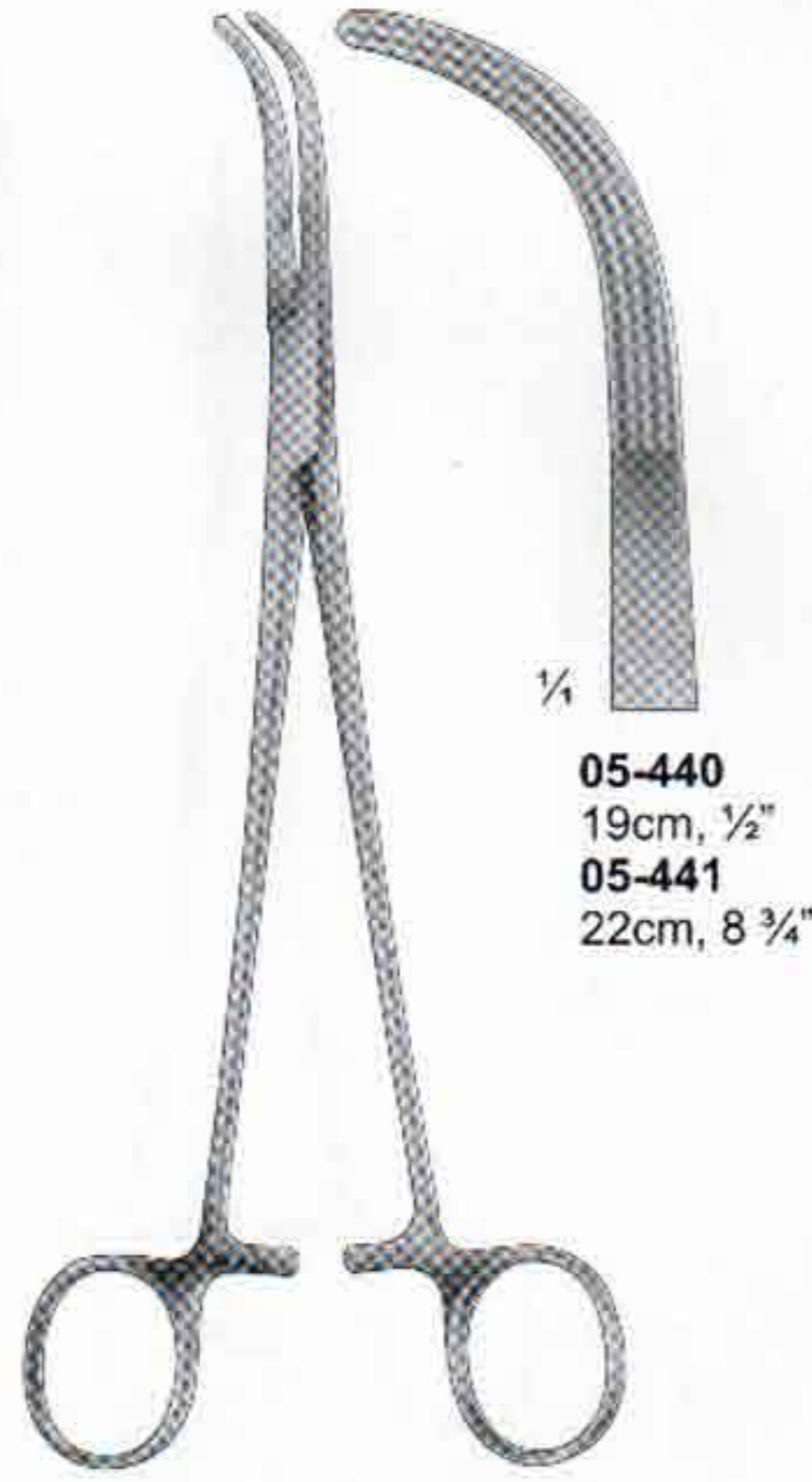

1/4  
05-440  
19cm, 1/2"  
05-441  
22cm, 8 3/4"

**LAHEY (SWEET)**

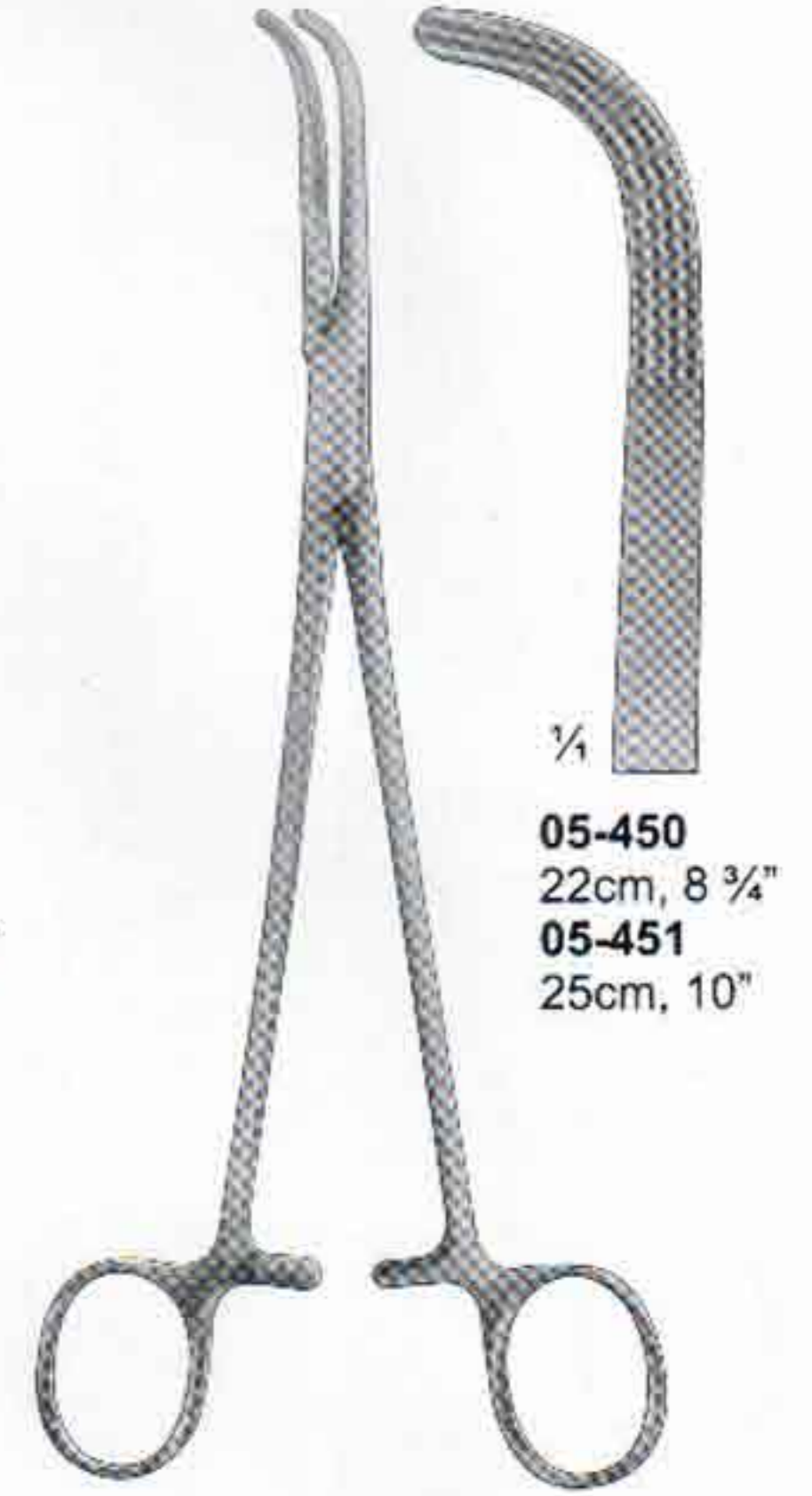

1/4  
05-450  
22cm, 8 3/4"  
05-451  
25cm, 10"

**MIXTER**



1/4  
05-460  
22cm, 8 3/4"

**DESJARDINS**

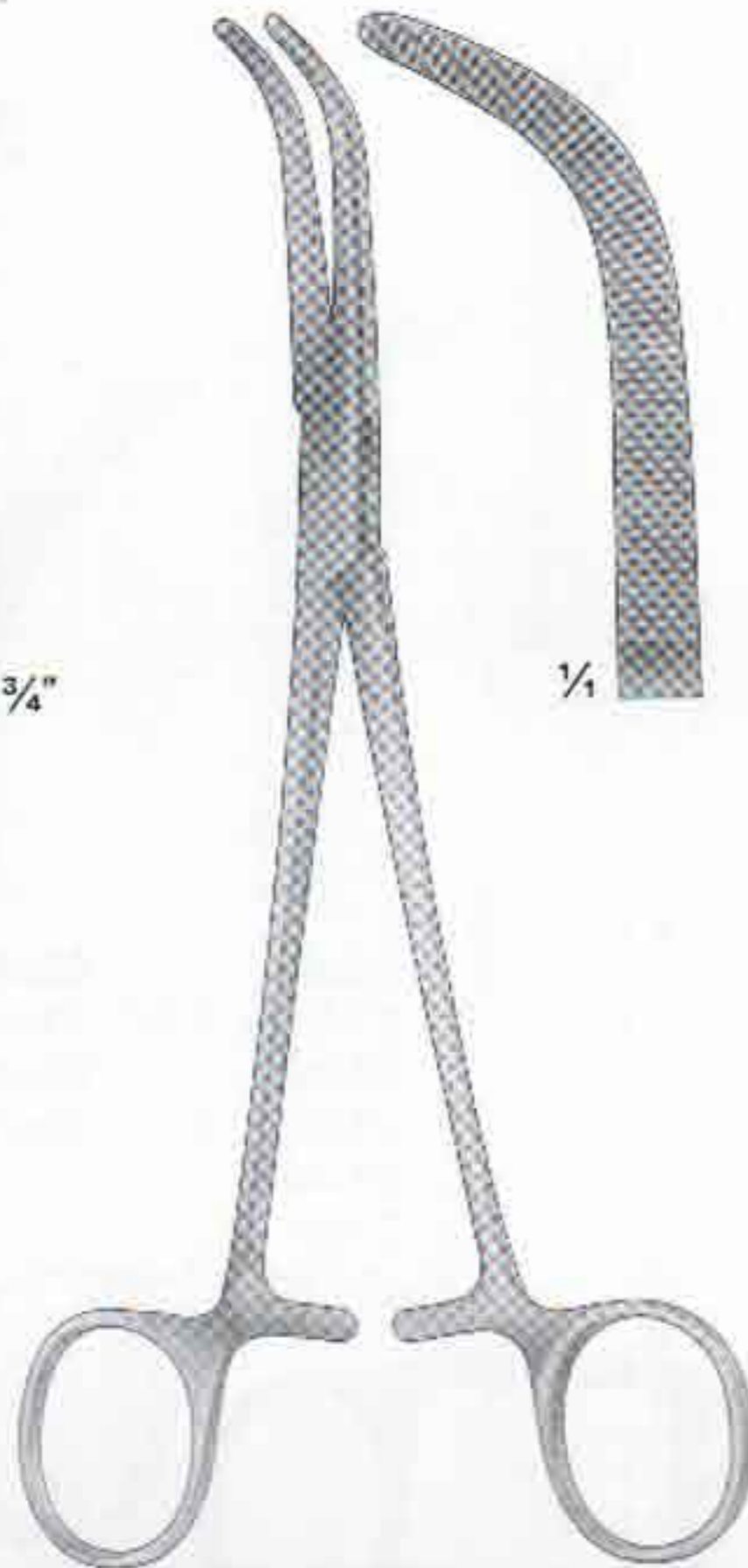

1/4

**MIXTER-O'SHAUGHNESSY**  
05-470  
19cm, 7 1/2"

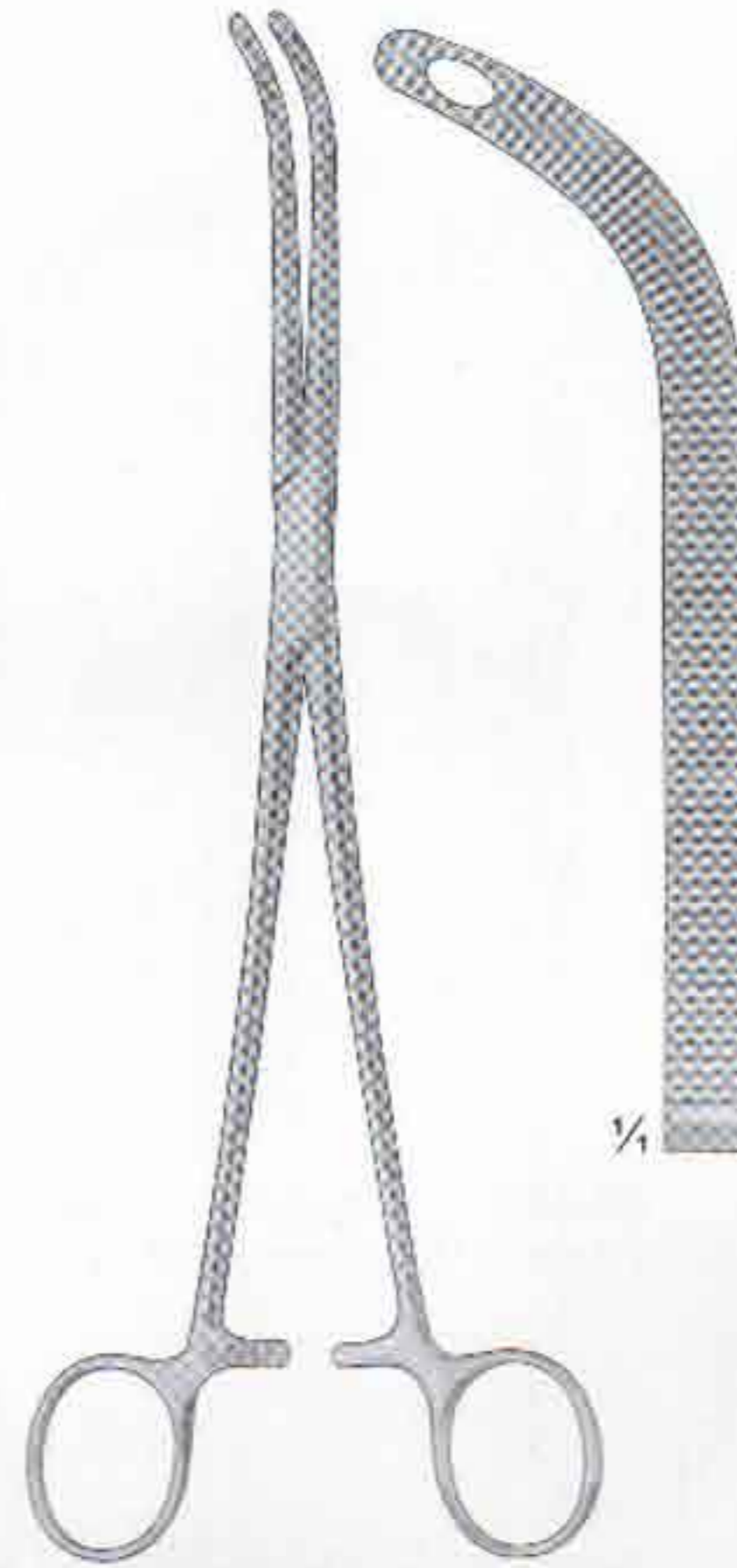

1/4

**FINOCHIETTO**  
05-480  
24.5cm, 9 1/2"



1/4

05-490  
24.5cm, 9 3/4"

**CRAFOORD**



# HAEMOSTATIC FORCEPS

Arterienklemmen  
Pinzas hemostaticas

Pinces hemostatiques  
Pinze emostatiche



¼  
05-500  
14.0 cm  
05-501  
18.0 cm

05-510  
23 cm, 9"

05-530  
23 cm, 9"

**BABY-MIXTER**

**STILLE**

**MAYO-GUYON**

**GUYON**

05-520 23 cm, 9"  
05-521 24 cm, 9 ½"

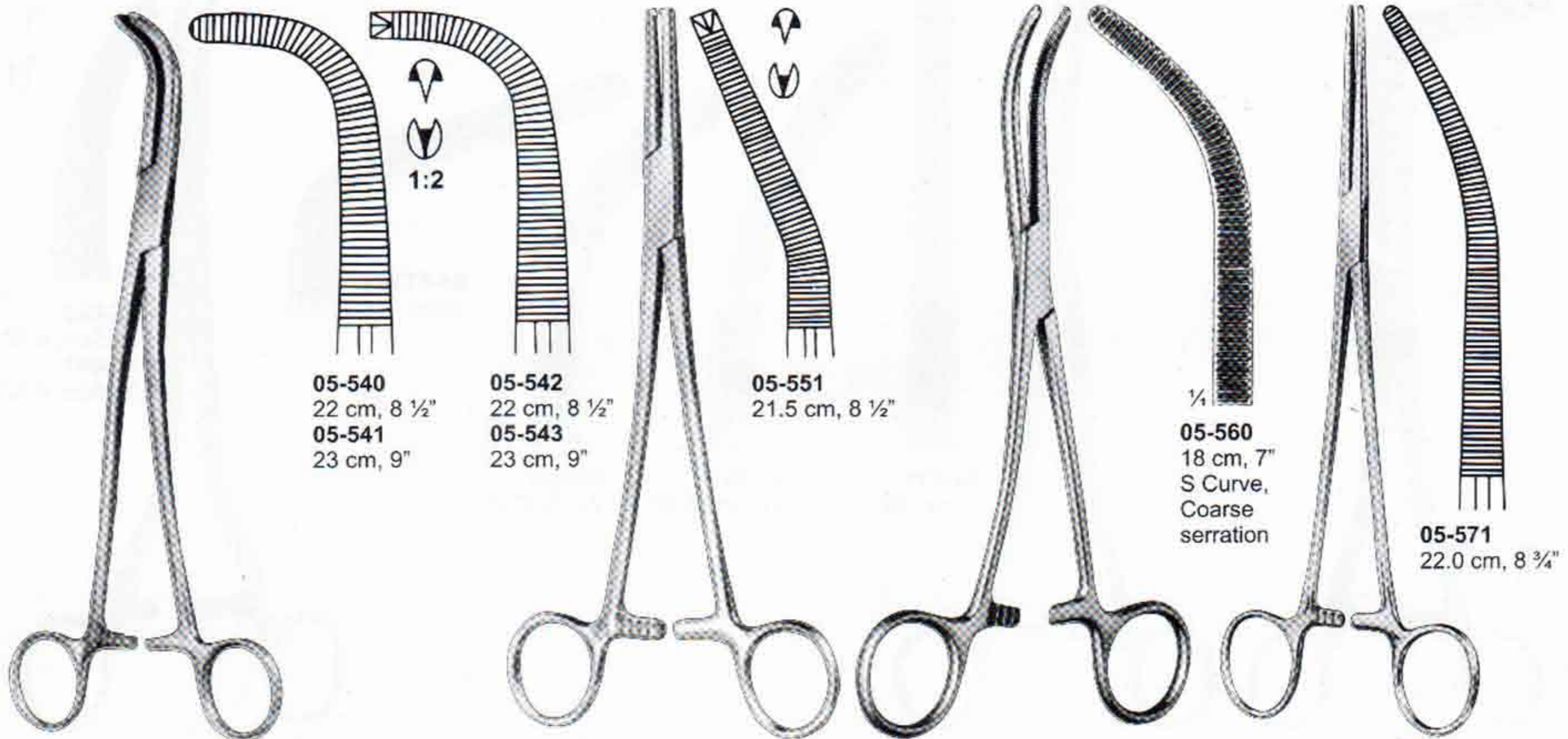

05-540  
22 cm, 8 ½"  
05-541  
23 cm, 9"

05-542  
22 cm, 8 ½"  
05-543  
23 cm, 9"

05-551  
21.5 cm, 8 ½"

¼  
05-560  
18 cm, 7"  
S Curve,  
Coarse  
serration

05-571  
22.0 cm, 8 ¾"

**GRAY**

**PHANEUF 1:2**

**DEAN-SHALLCROSS**

**ROBERTS**

05-550  
21.5 cm, 8 ½"

05-570  
22.0 cm, 8 ¾"



# HAEMOSTATIC FORCEPS

Arterienklemmen  
Pinzas hemostaticas

Pinces hemostatiques  
Pinze emostatiche

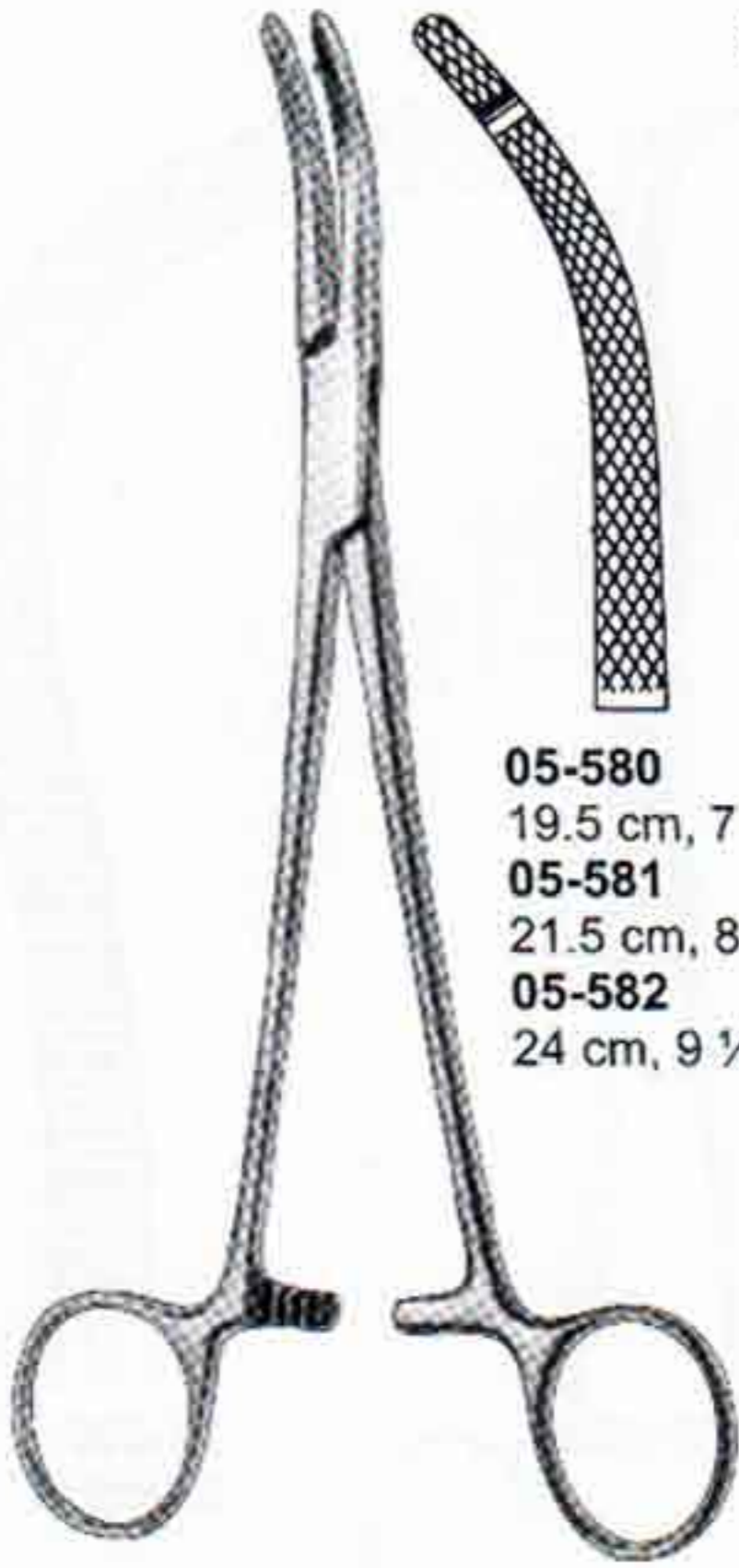

**05-580**  
19.5 cm, 7 1/2"  
**05-581**  
21.5 cm, 8 1/2"  
**05-582**  
24 cm, 9 1/2"

**HEANEY**



**05-583**  
19.5 cm, 7 1/2"  
**05-584**  
21.5 cm, 8 1/2"  
**05-585**  
24 cm, 9 1/2"

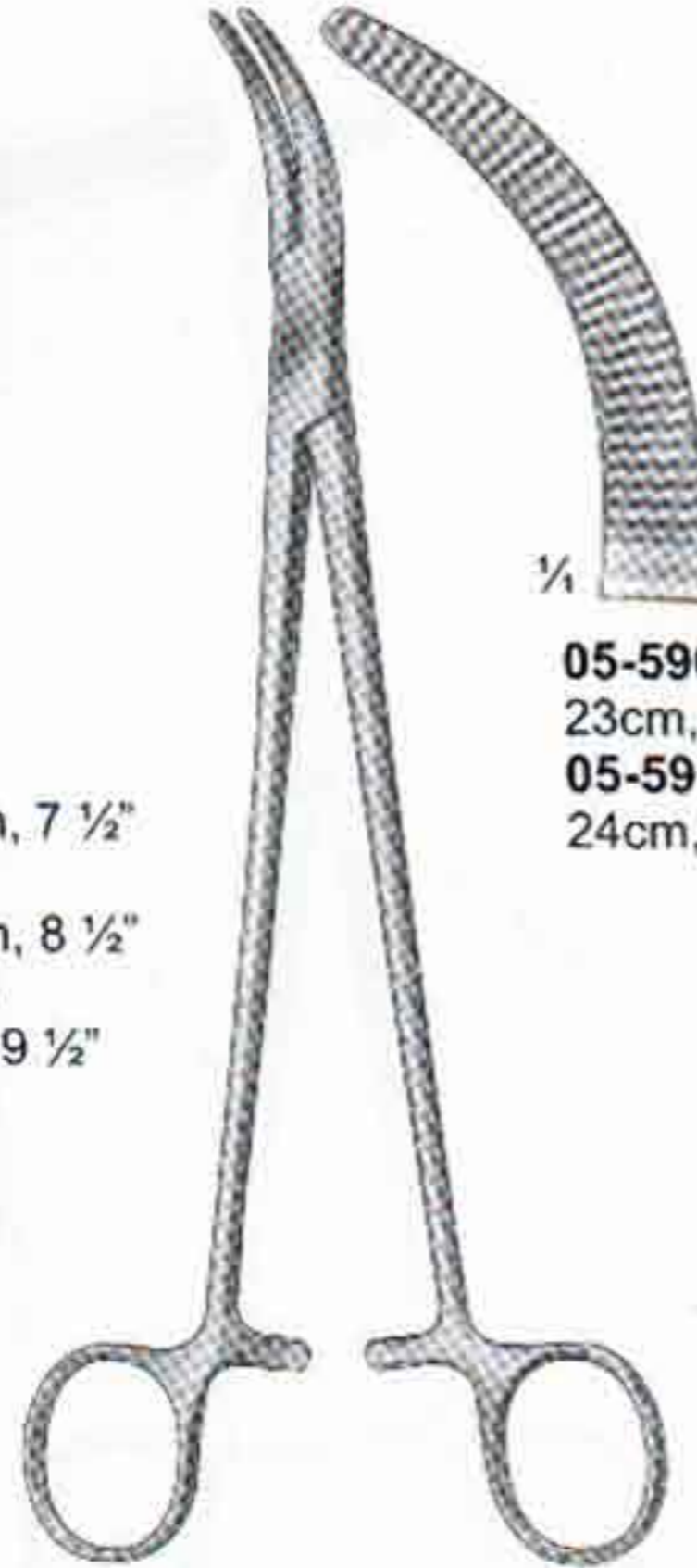

**MOYNIHAN**

1/4  
**05-590**  
23cm, 9"  
**05-591**  
24cm, 9 3/4"

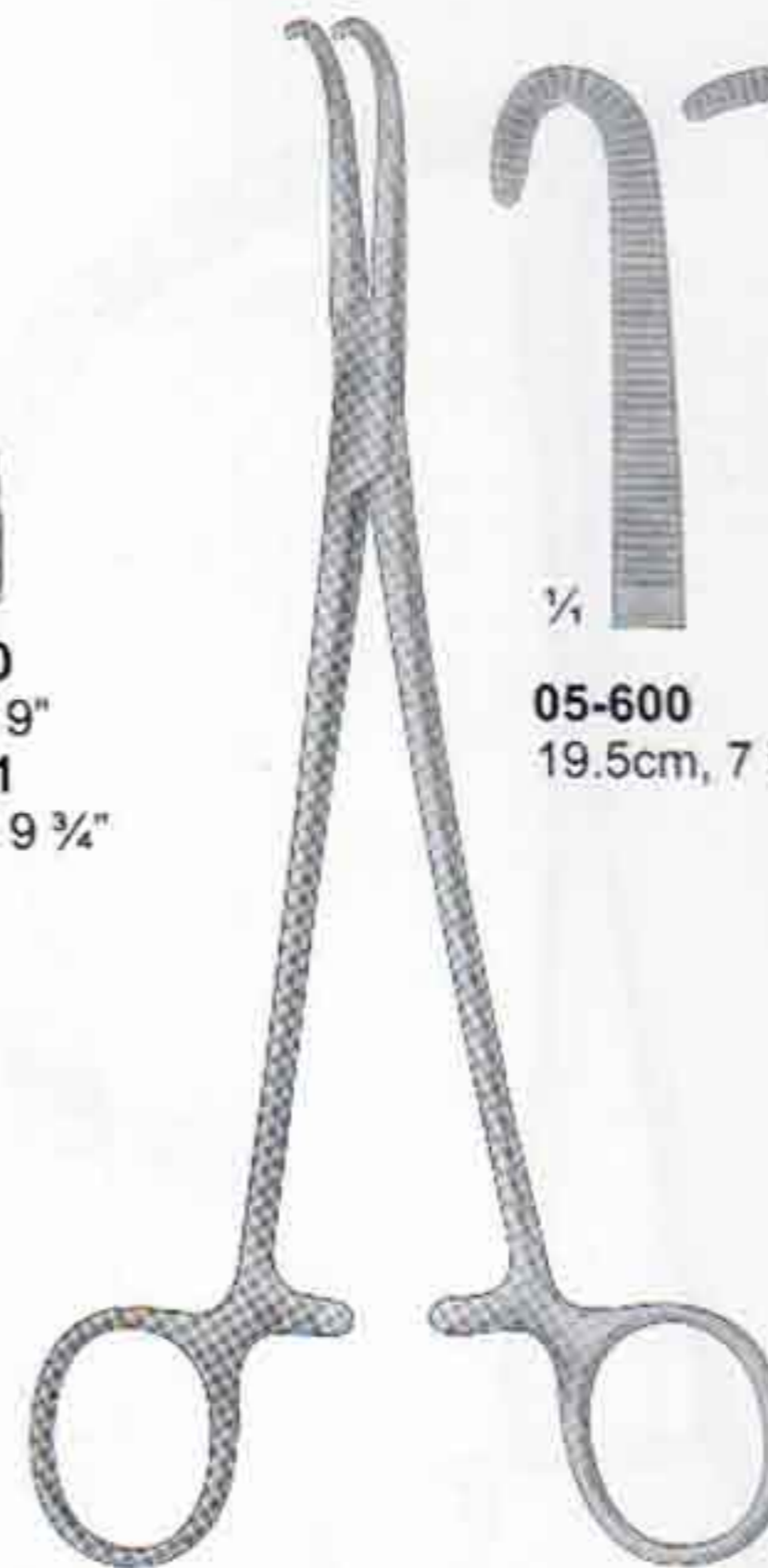

**NEGUS**

1/4  
**05-600**  
19.5cm, 7 3/4"  
**05-601**  
19.5cm, 7 3/4"



**WERTHEIM-CULLEN**  
**05-610** 60mm  
**05-611** 80mm  
23cm, 9"

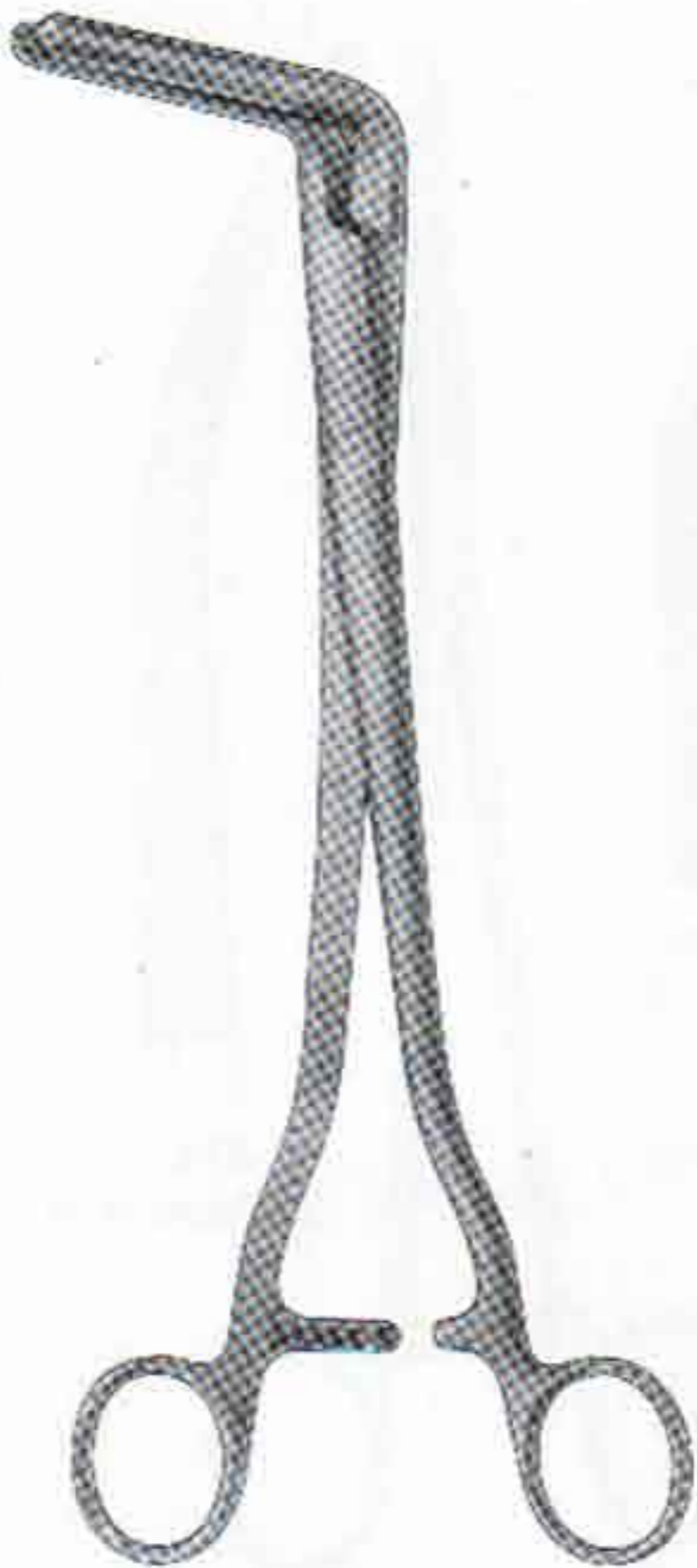

**WERTHEIM**  
**05-620**  
25cm, 10"

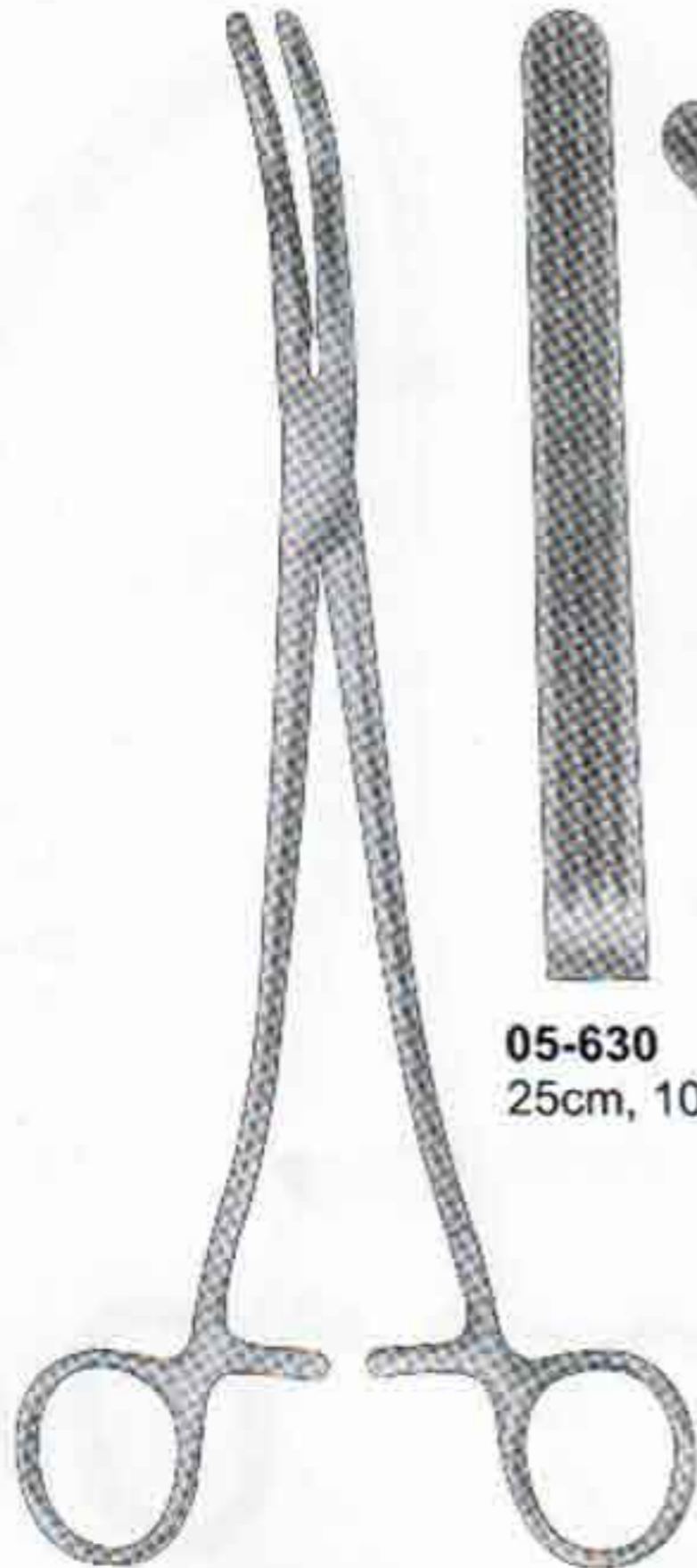

**WERTHEIM**  
Parametrium Clamps

**05-630**  
25cm, 10"

**05-631**  
24.5cm, 9 3/4"

**05-632**  
24cm, 9 1/2"



**05-633**  
22cm, 8 3/4"

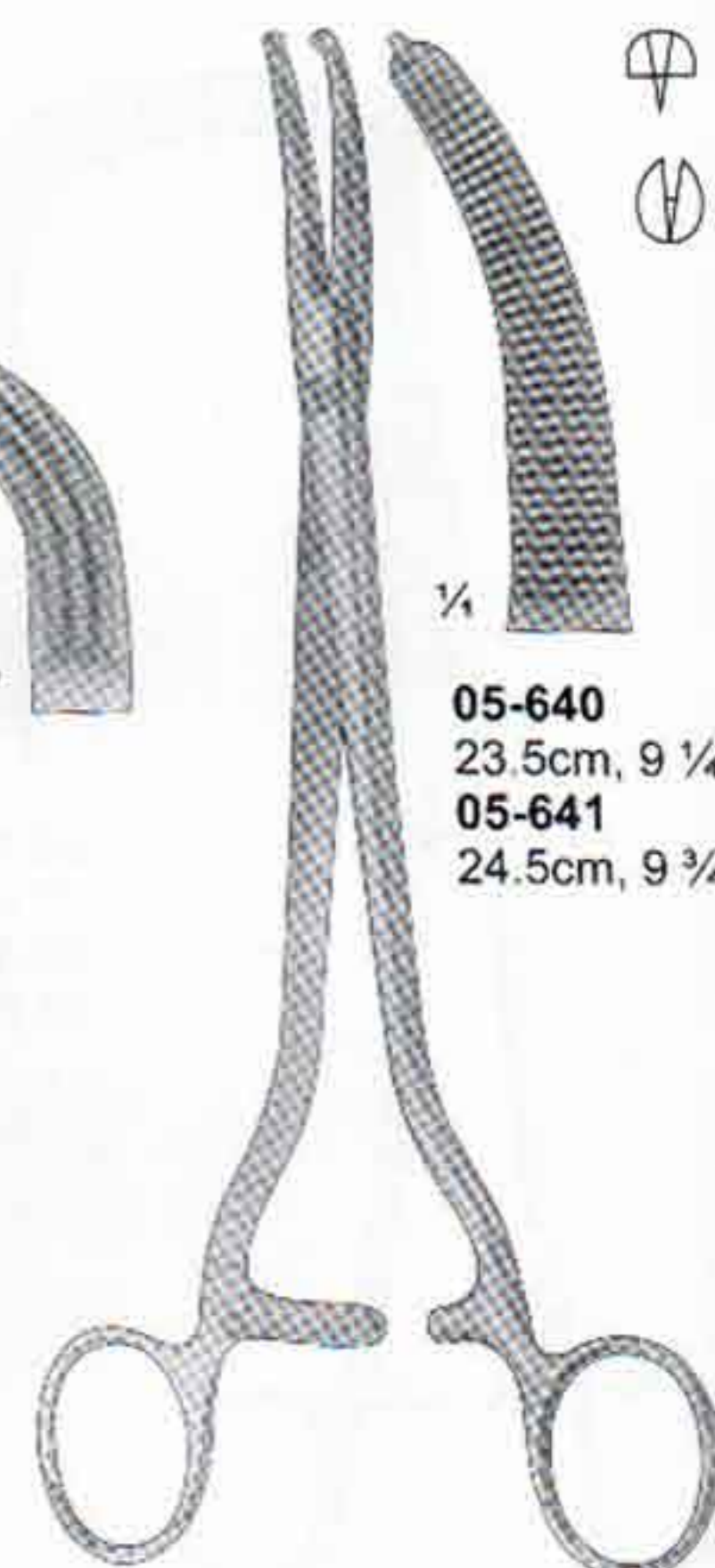

**WERTHEIM**

1/4  
**05-640**  
23.5cm, 9 1/4"  
**05-641**  
24.5cm, 9 3/4"



# HAEMOSTATIC FORCEPS, TUBING CLAMPS

Arterienklemmen, Schlauchklemmen  
Pinzas hemostaticas, Pinzas para tubos

Pinces hemostatiques, Pinces presse-Tubes  
Pinze emostatiche, Pinze serratubi

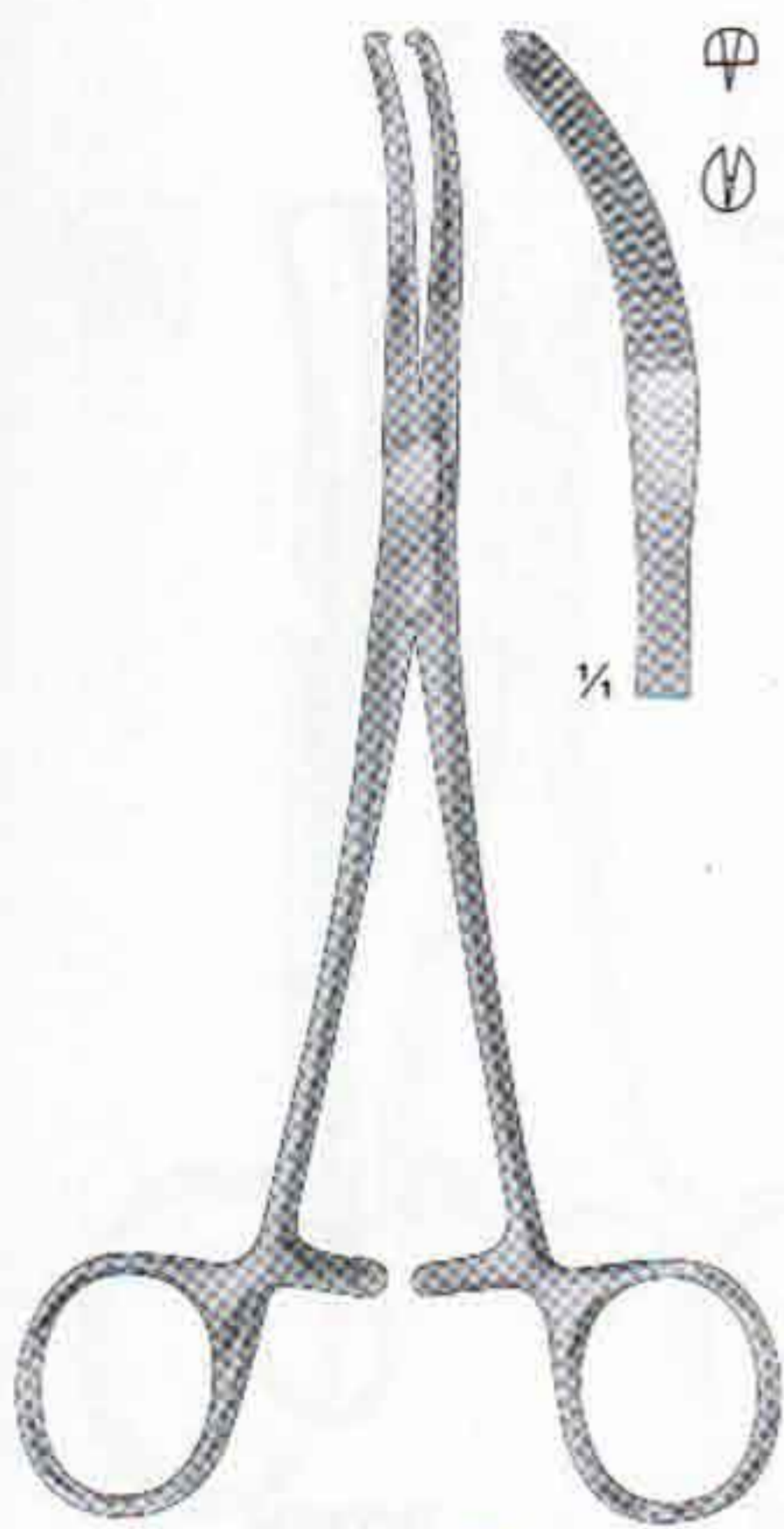

**MIKULICZ**  
**05-650**  
18.5cm, 7 1/4"

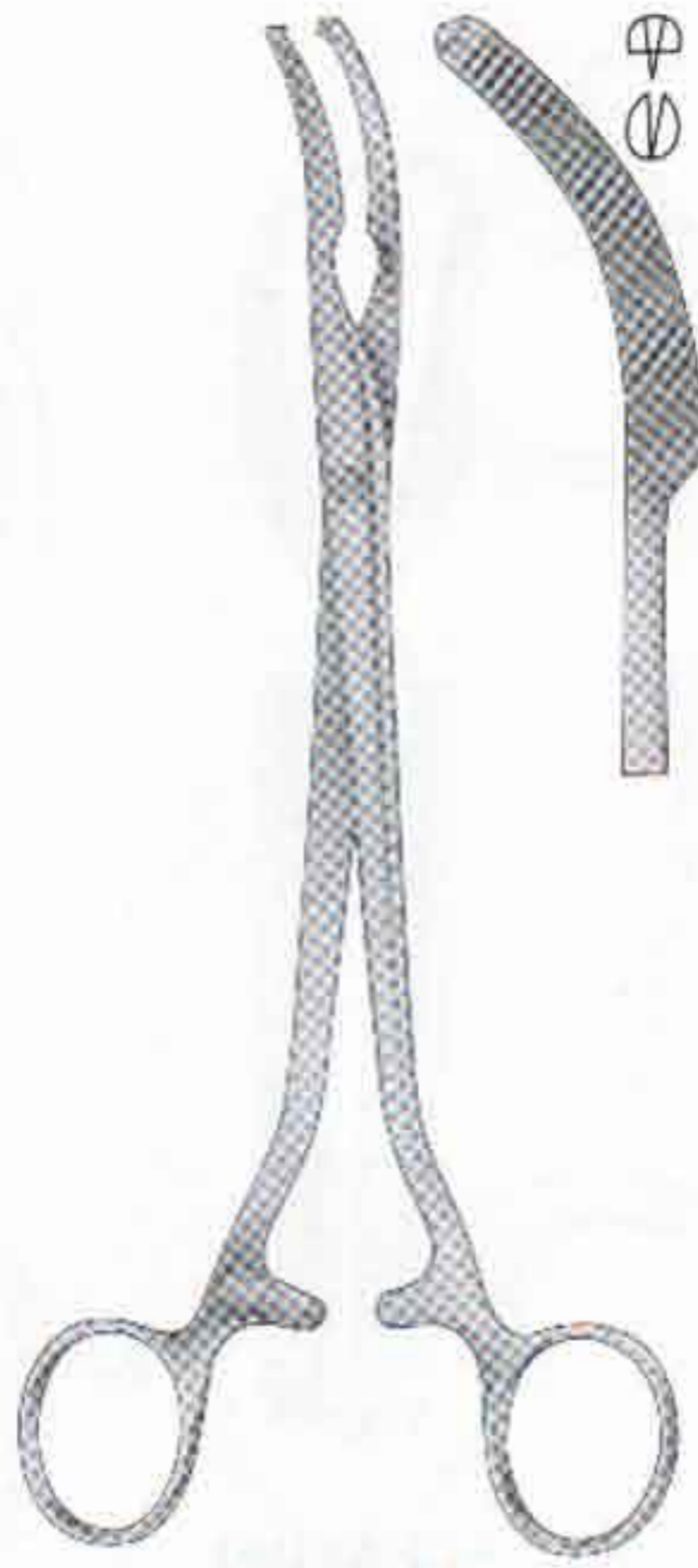

**MIKULICZ**  
**05-660**  
20.5cm, 8"

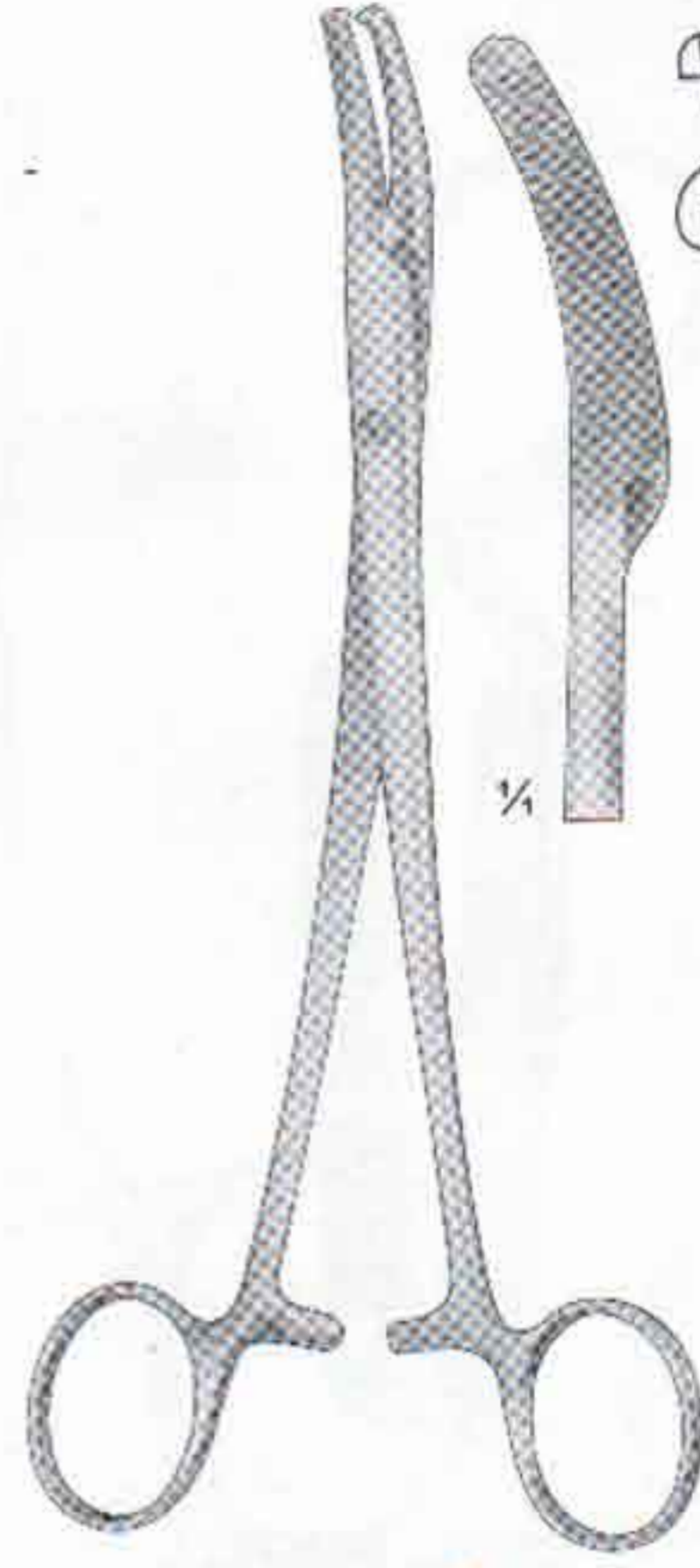

**MIKULICZ**  
**05-670**  
20cm, 8"

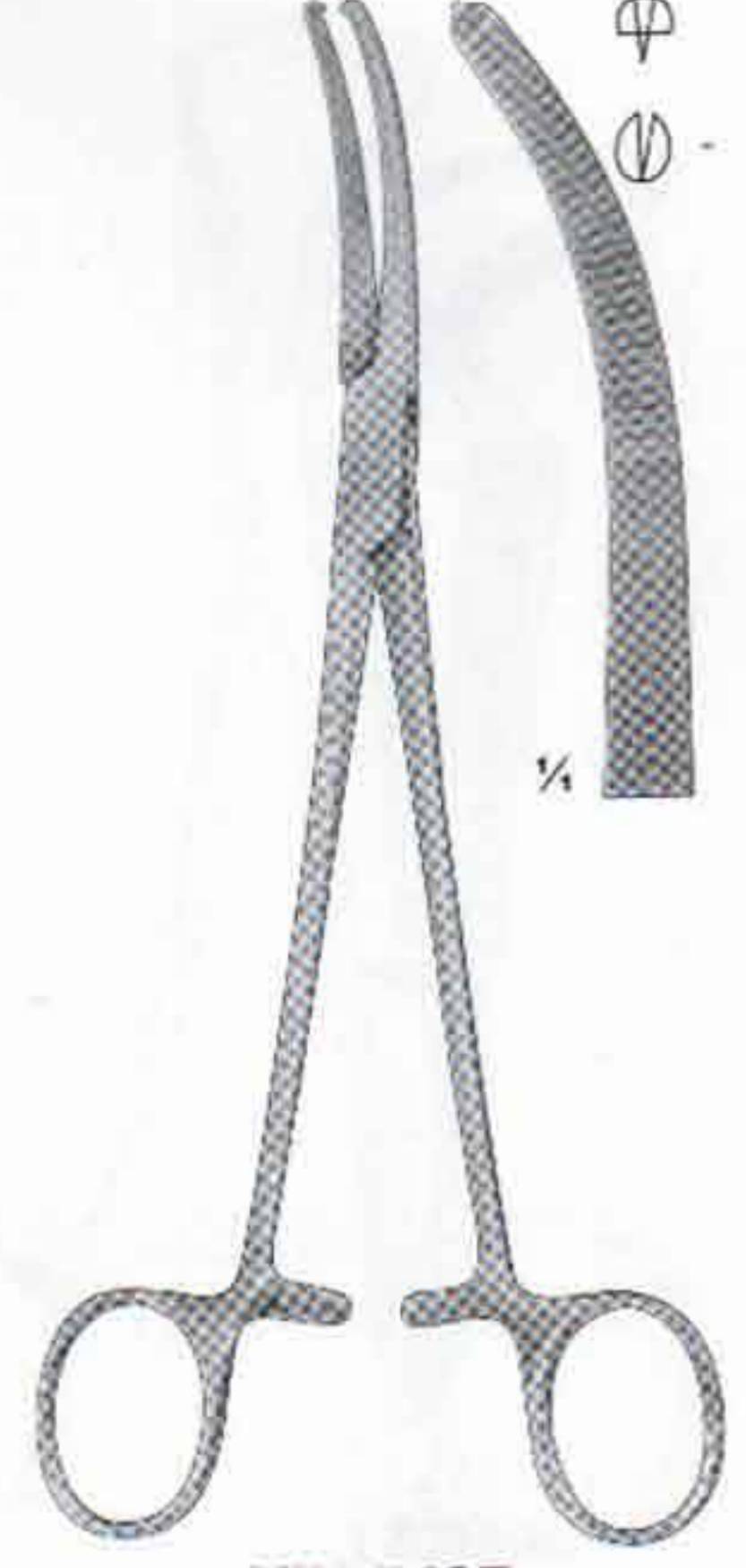

**MIKULICZ**  
**05-680**  
20.5cm, 8"

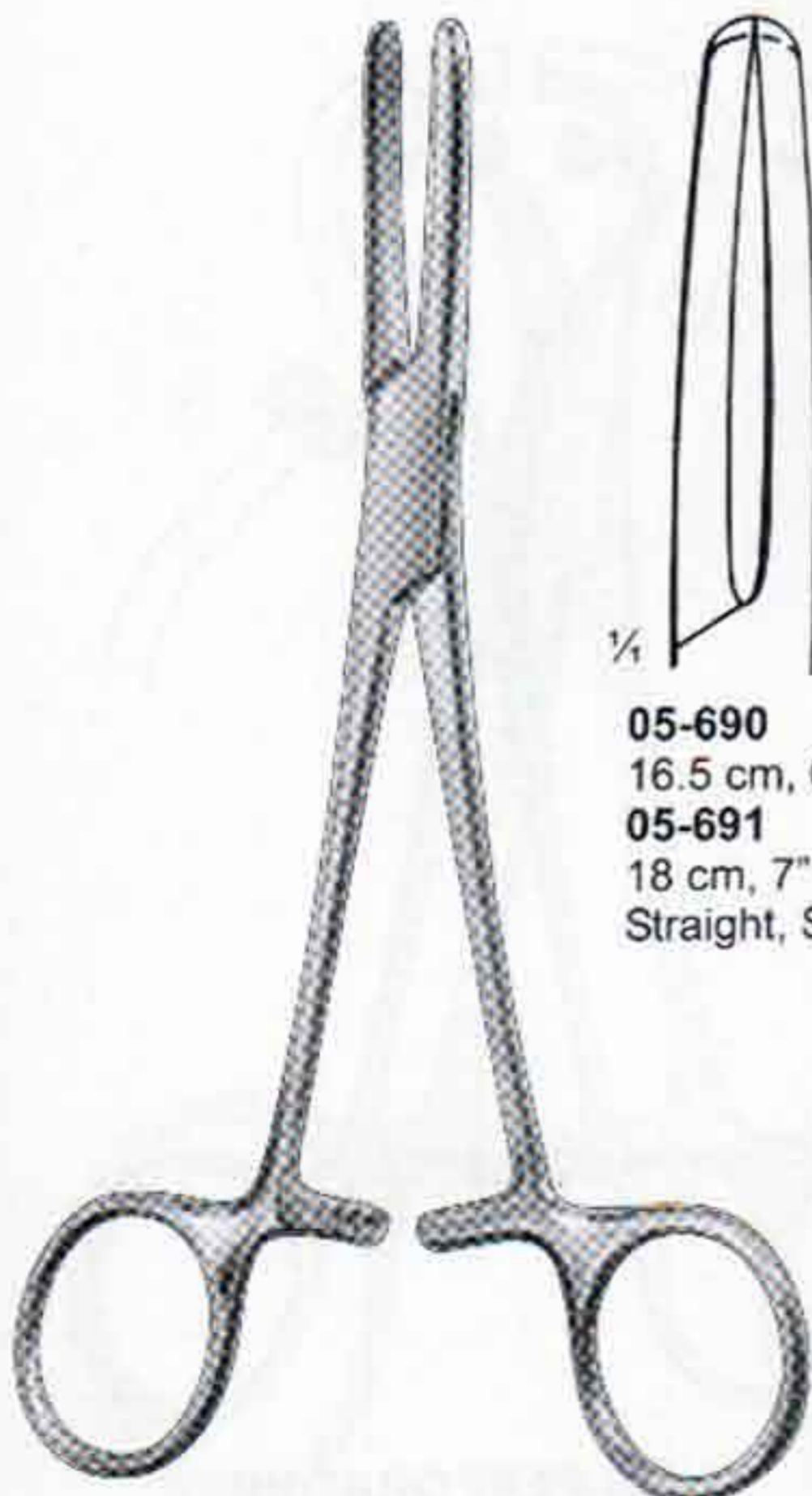

**05-690**  
16.5 cm, 6 1/2"  
**05-691**  
18 cm, 7"  
Straight, Smooth

**PRESBYTERIAN**

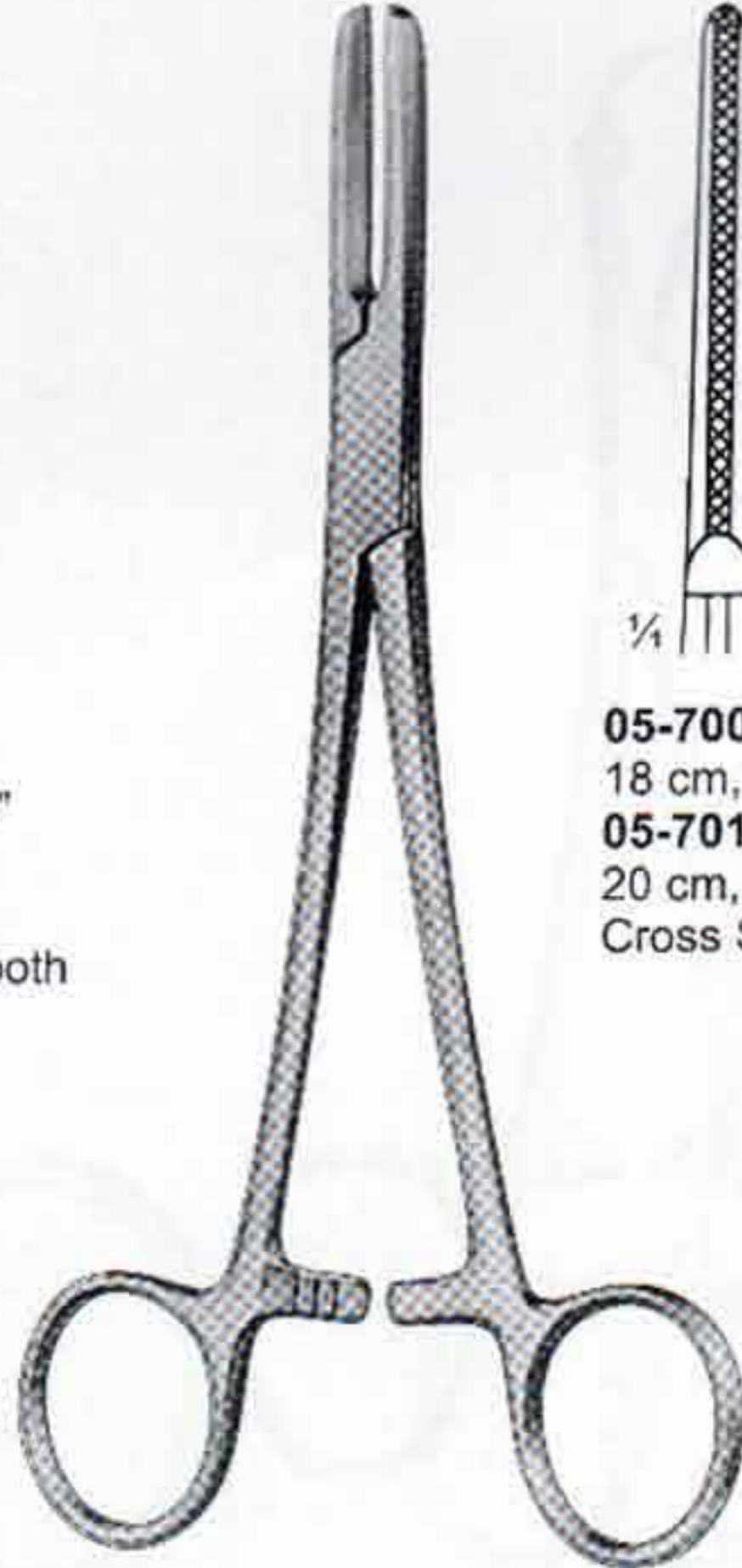

**05-700**  
18 cm, 7"  
**05-701**  
20 cm, 8"  
Cross Serrated

**TUBING**

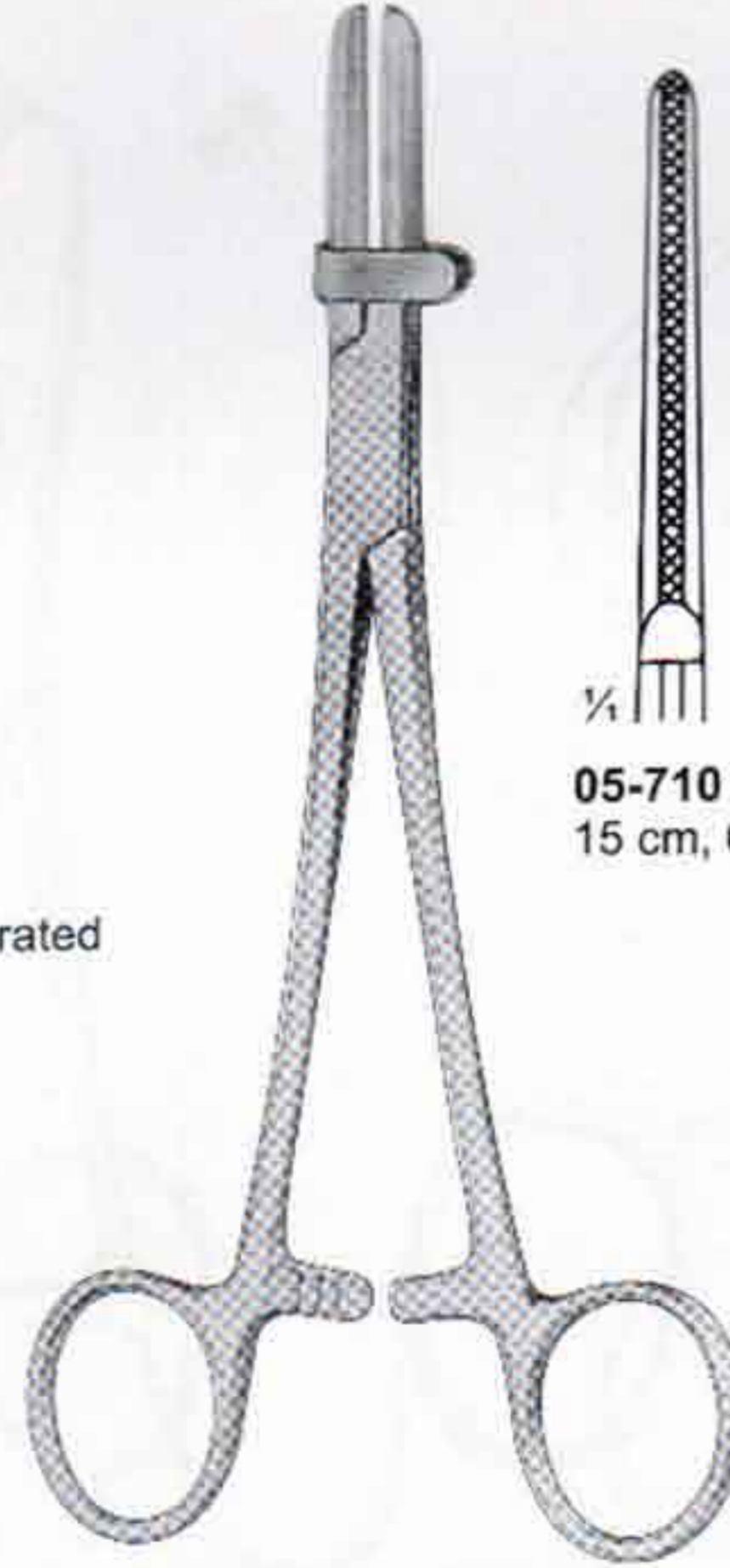

**05-710**  
15 cm, 6"

**05-711**  
18 cm, 7"

**05-712**  
20 cm, 8"

**TUBING CLUMP**  
with Protector,  
Cross Serrated



# TOWEL FORCEPS

Tuchklemmen  
Pinzas de campo

Pinces à champs  
Pinze fissatele



**JONES /  
PERFORATING**  
05-720  
9 cm, 3 1/2"  
Slight Curve



**ENGL. MODELL**  
05-730  
9 cm, 3 1/2"



**SCHAEDEL**  
05-740  
9 cm, 3 1/2"



**DOYEN**  
05-750  
18 cm, 7"

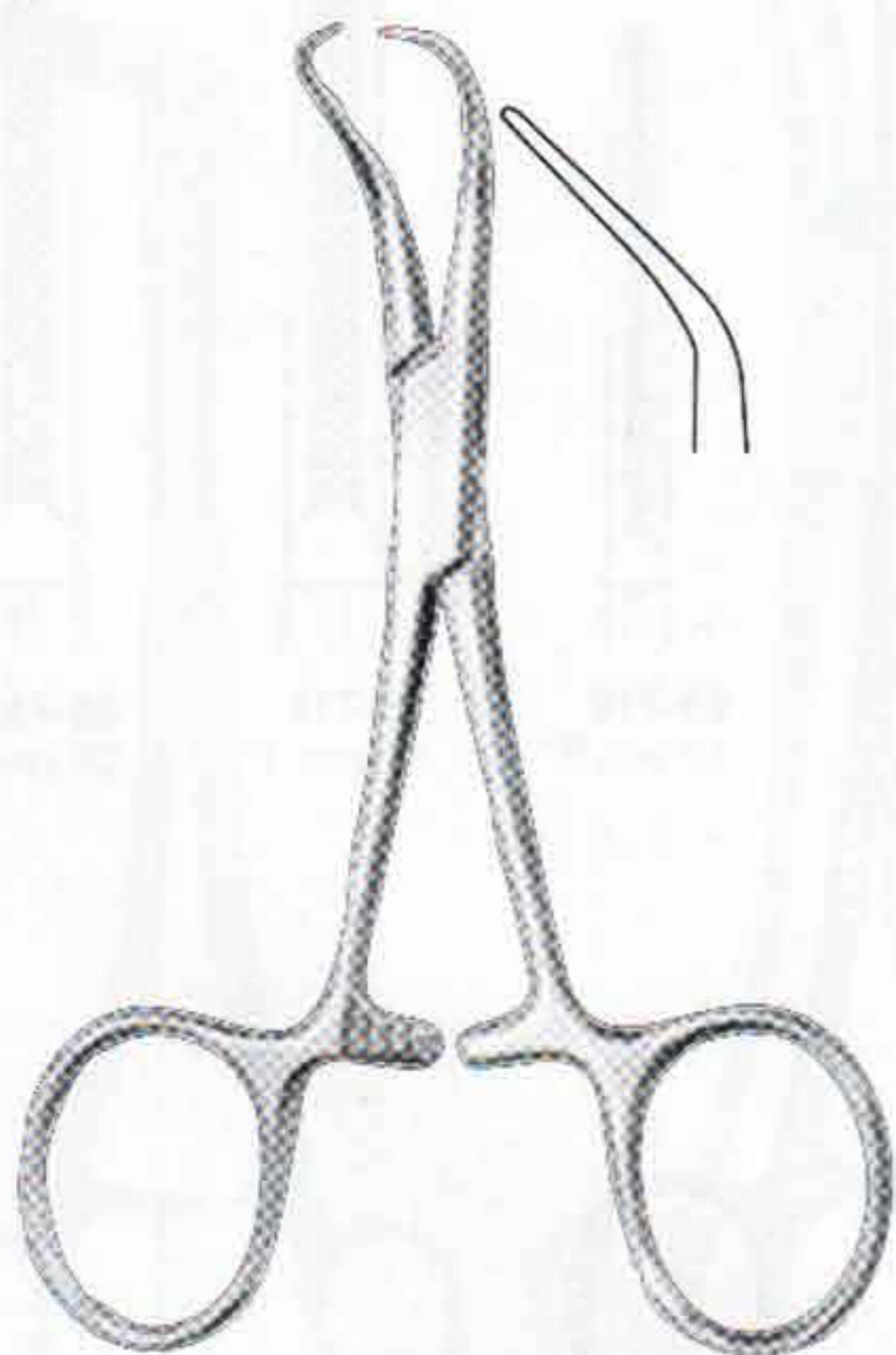

**BACKHAUS**  
05-760 8 cm, 3"  
05-761 11 cm, 4 1/2"  
05-762 13 cm, 5"  
05-763 15 cm, 5 3/4"  
Curved

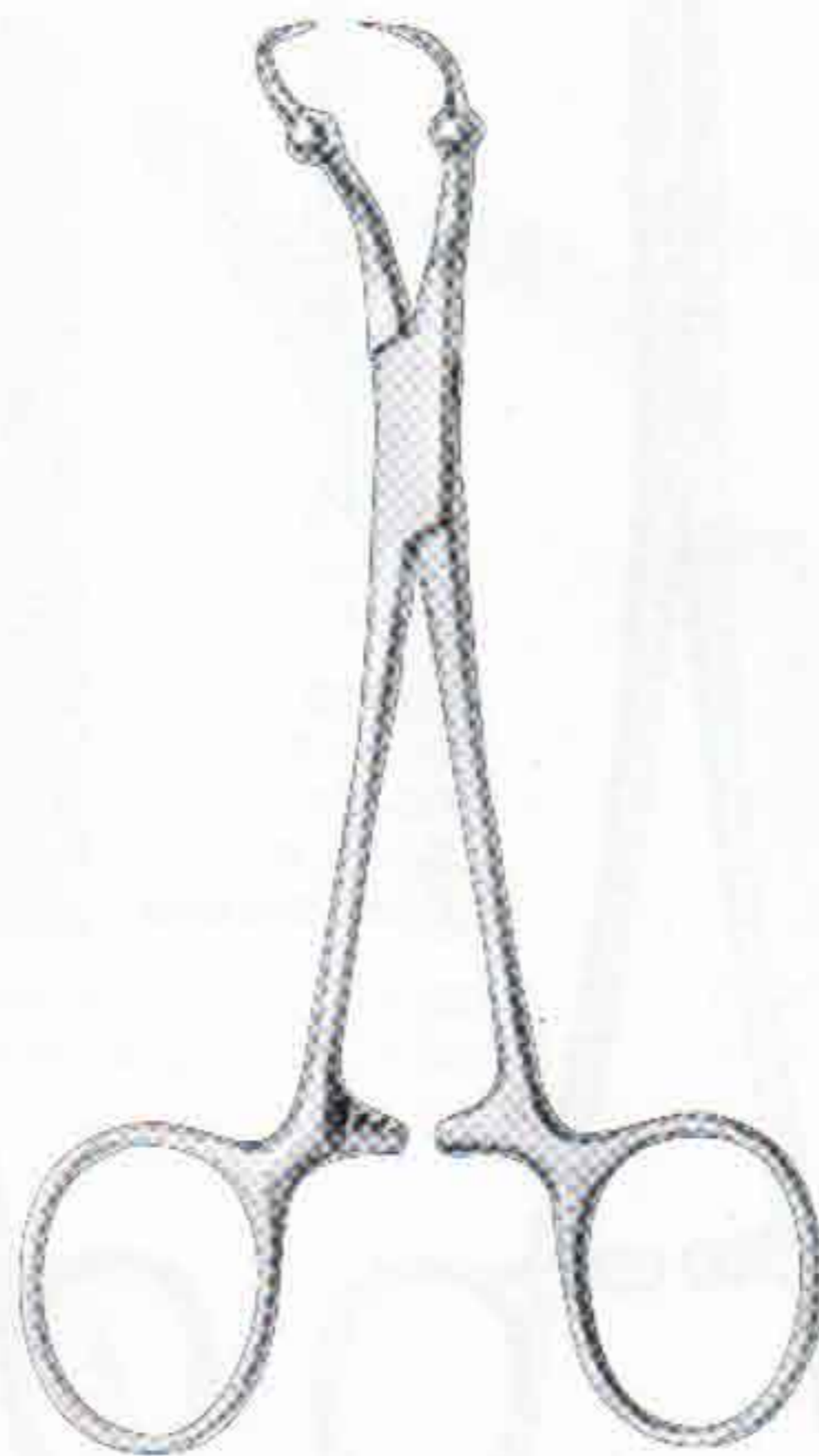

**ROEDER**  
05-770 13 cm, 5"  
05-771 15 cm, 6"  
Curved, Serrated

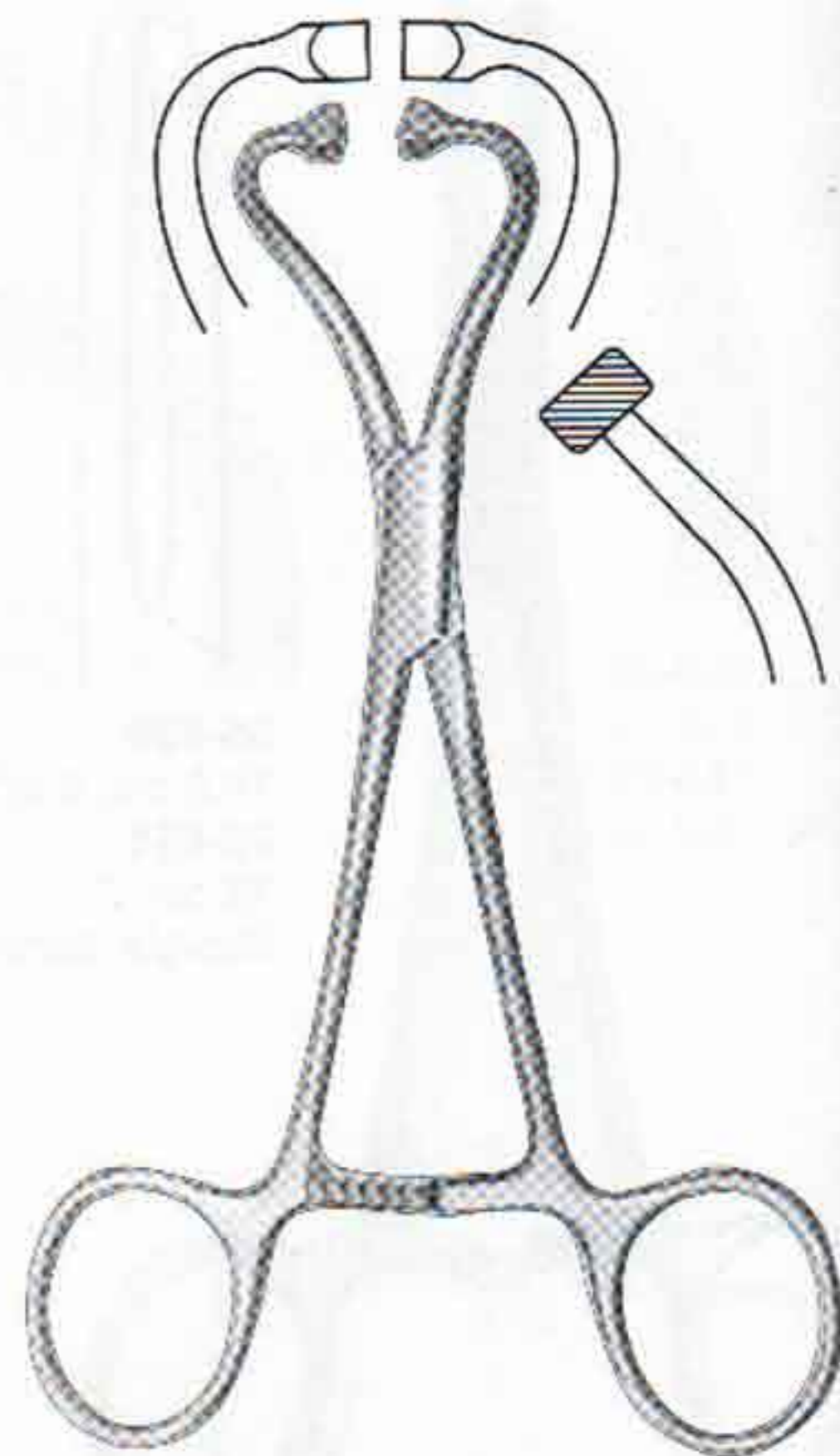

**NON-PERFORATING**  
05-780 11 cm, 4 1/2"  
05-781 13 cm, 5"



# TOWEL FORCEPS

Tuchklemmen  
Pinzas de campo

Pinces à champs  
Pinze fissatele

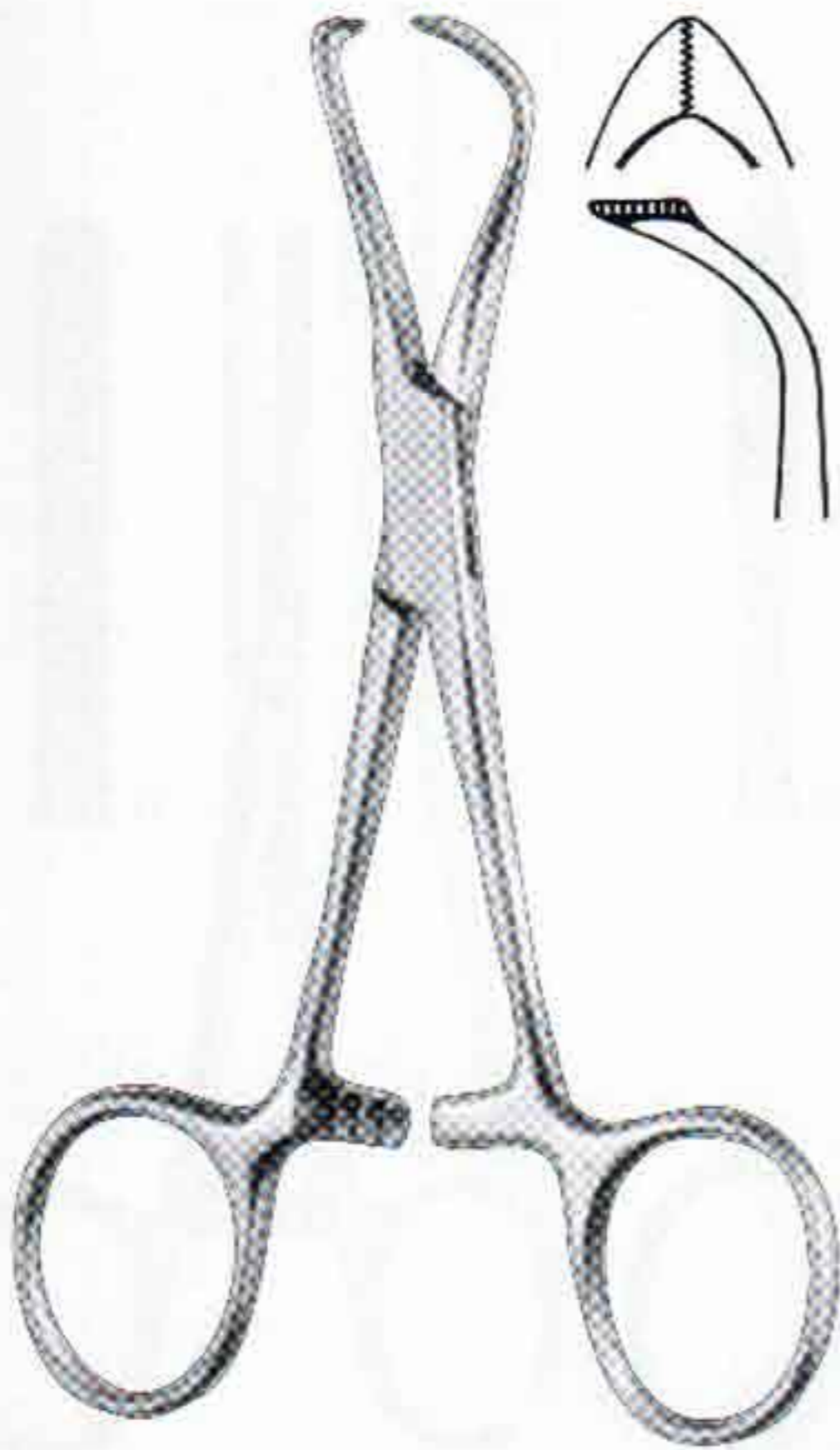

**LORNA**  
05-790 10 cm, 4"  
05-791 11 cm, 4 ½"  
05-792 13 cm, 5"



**BACKHAUS CLIP**  
05-800 11 cm, 4 ½"  
with clip for tubing or  
cable



**BALL & SOCKET**  
05-810 13 cm, 5"  
Non-perforating

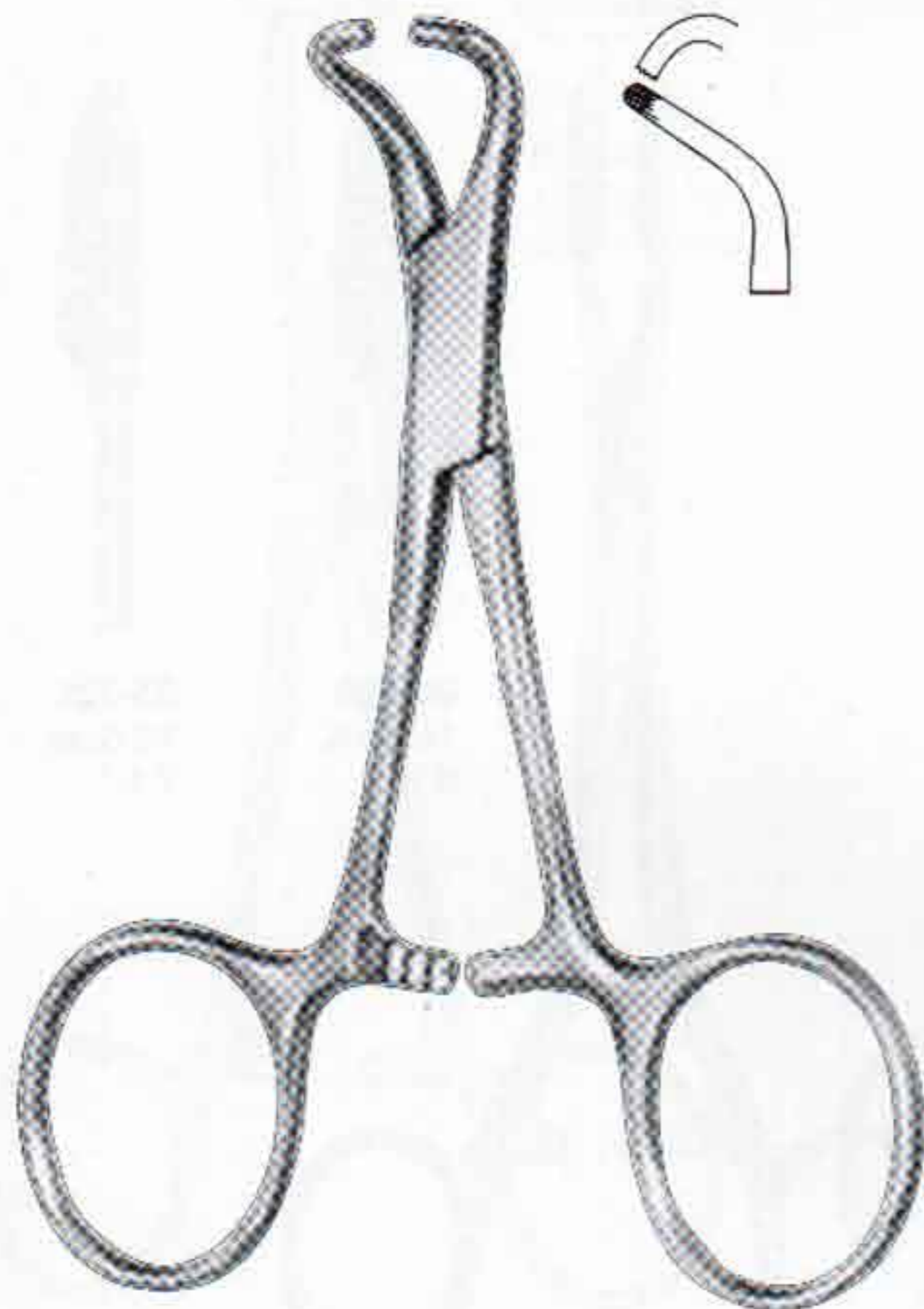

**TOHOKU**  
05-820 10cm, 4"  
05-821 13cm, 5"  
Non-Perforating

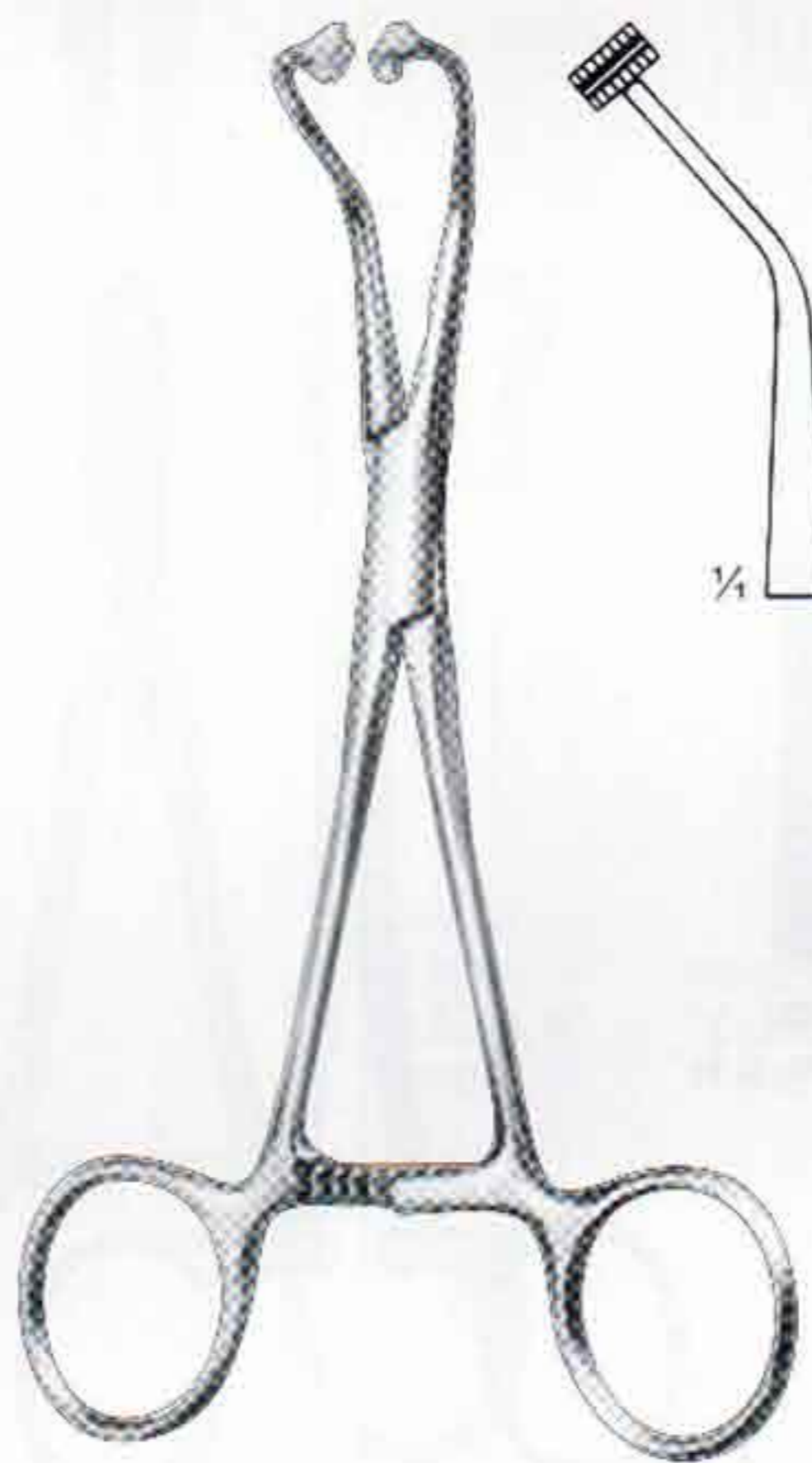

**PEERS-BERTMAN**  
05-830  
14.5 cm, 5 ¾"  
Serrated

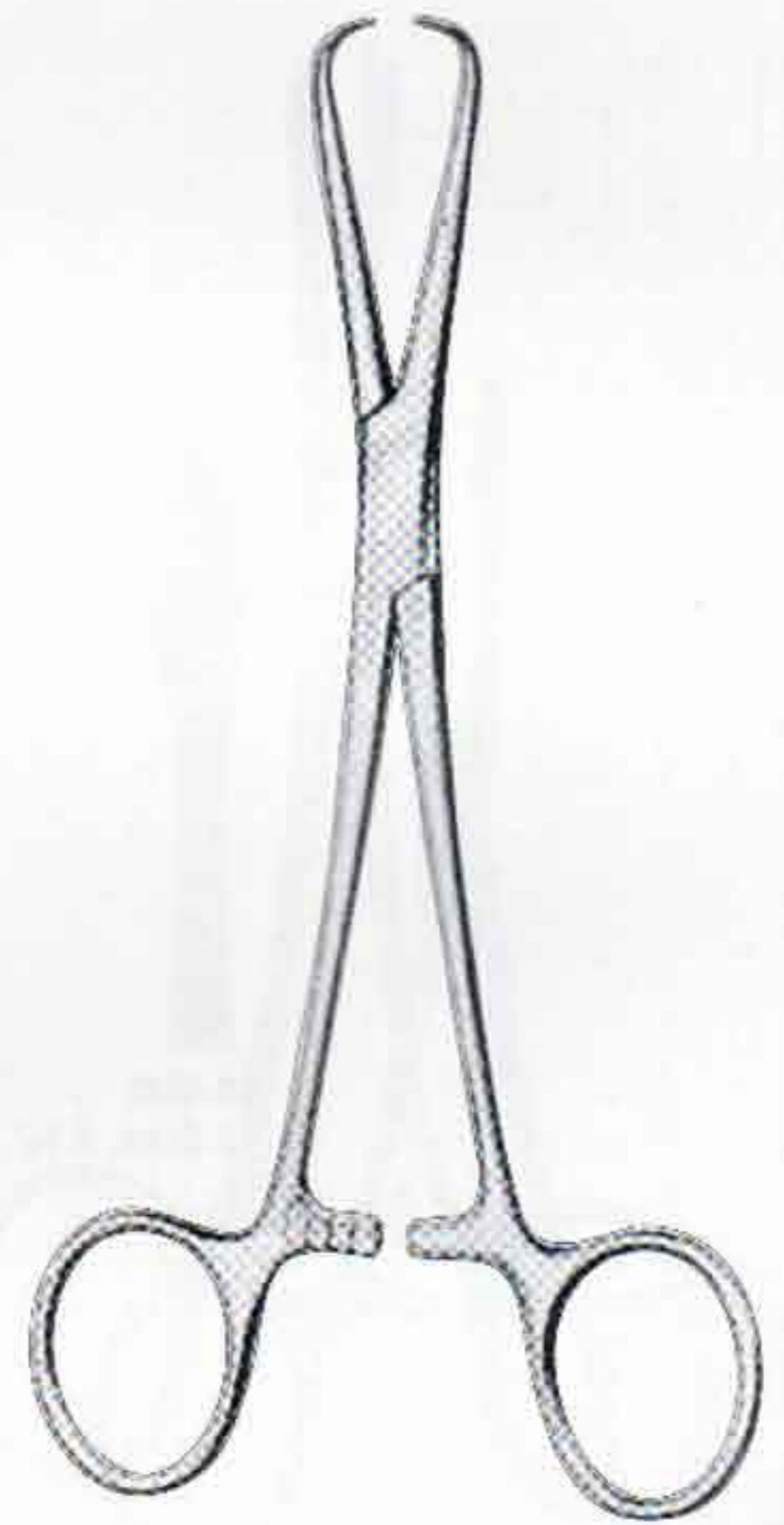

**BERNHARD**  
05-840  
16.5 cm, 6 ½"



# HAEMOSTATIC FORCEPS

Arterienklemmen  
Pinzas hemostaticas

Pinces hemostatiques  
Pinze emostatiche



<b>05-870</b>	<b>05-871</b>	<b>05-872</b>
13cm	15.5cm	17.5cm
5 1/4"	6"	7"

**FRICKE**  
Artery Forceps  
**05-850**  
13cm, 5 1/4"

**BRYANT**  
**05-860**  
13cm, 5 1/4"

**LISTER**  
Sinus Forceps

**KRONLENIN**  
**05-880**  
13cm, 5 1/4"

**PEAN**  
**05-890**  
12.5cm, 4 3/4"

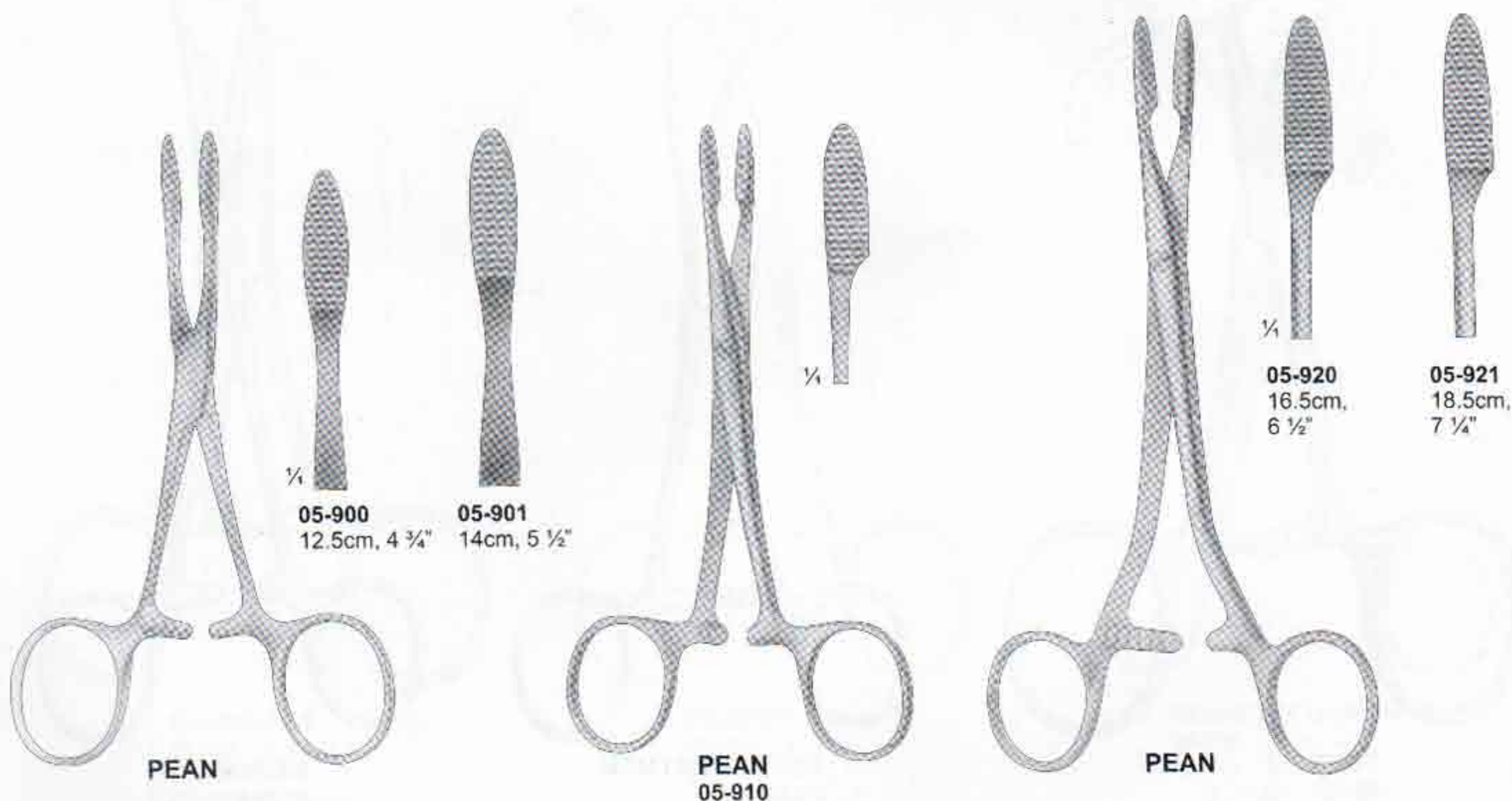

**05-900**  
12.5cm, 4 3/4"

**05-901**  
14cm, 5 1/2"

**PEAN**  
**05-910**

**05-920**  
16.5cm,  
6 1/2"

**05-921**  
18.5cm,  
7 1/4"

**PEAN**

**PEAN**



# HAEMOSTATIC FORCEPS

Arterienklemmen  
Pinzas hemostaticas

Pinces hemostatiques  
Pinze emostatiche

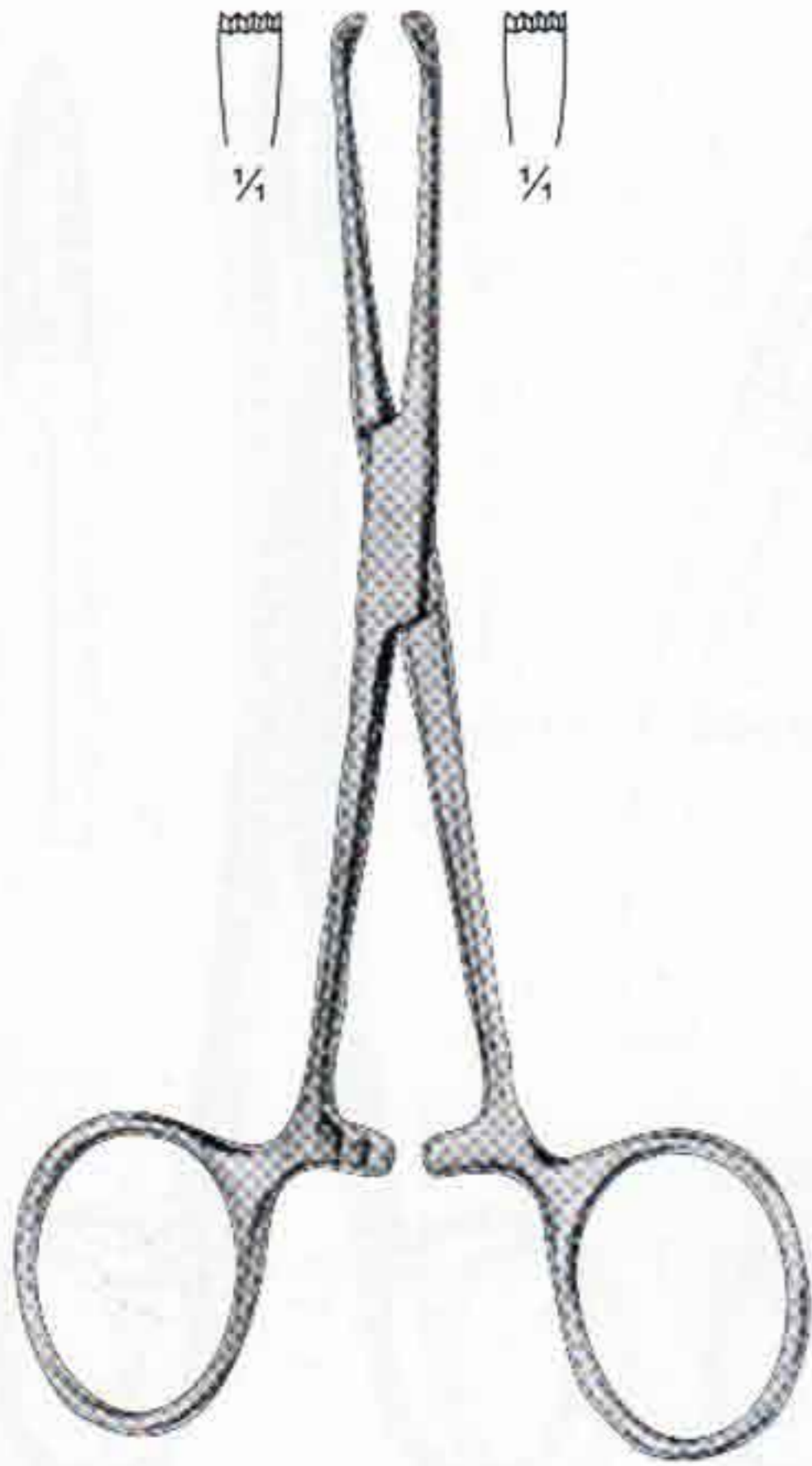

**TUFFIER**  
05-930  
13.0 cm, 5"

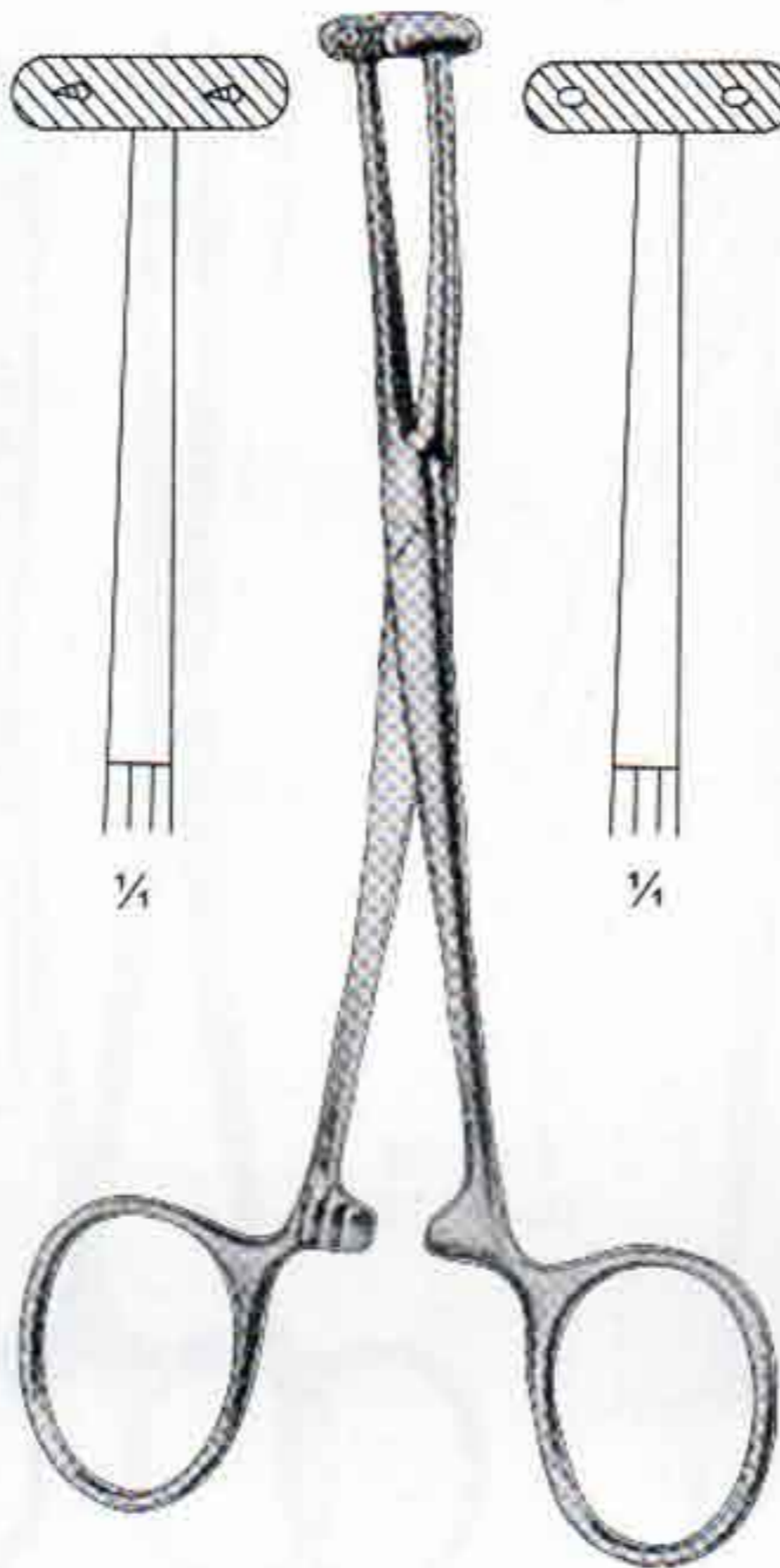

**MARTEL**  
05-940  
14.0 cm, 5 1/2"

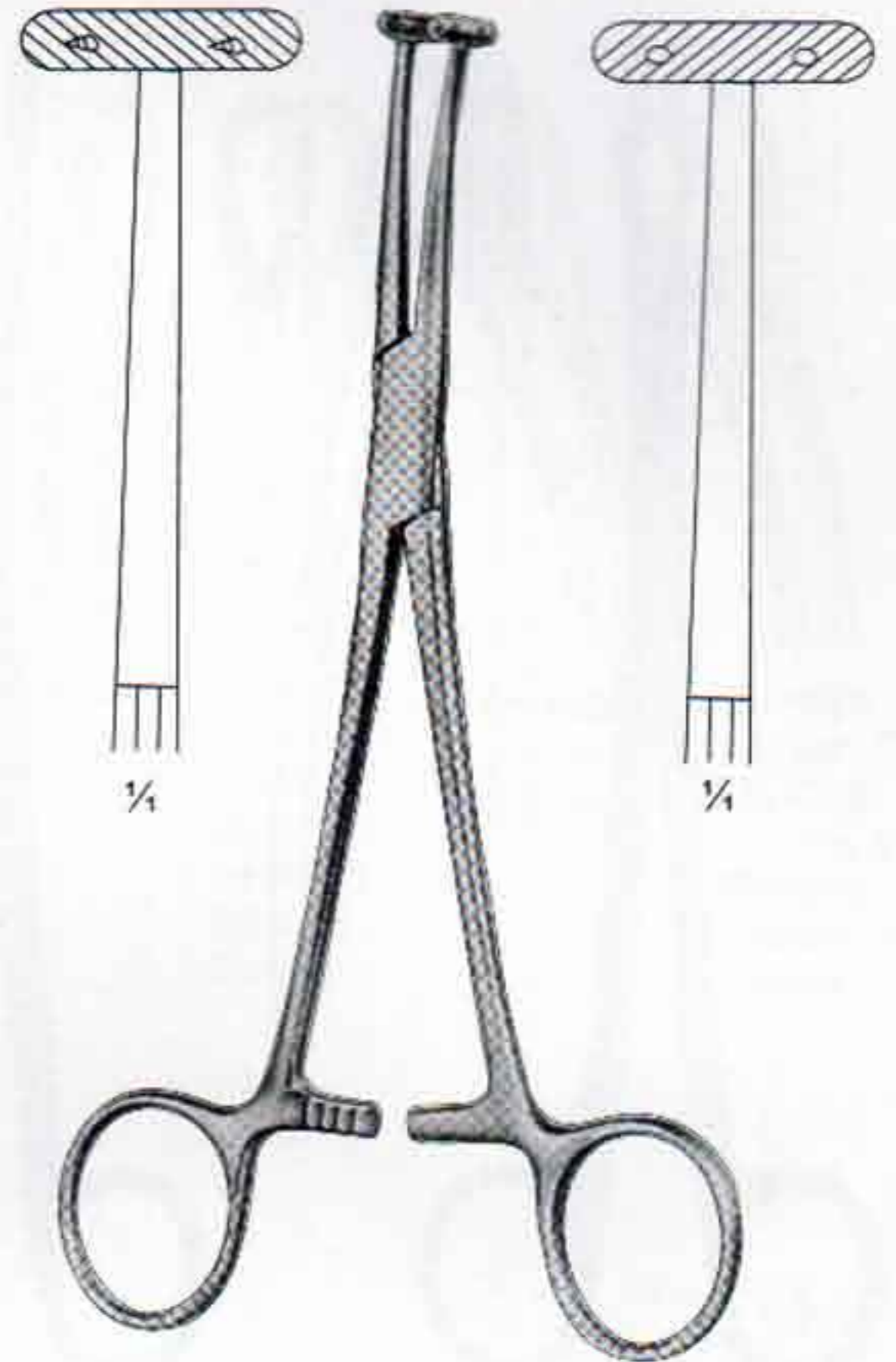

**WILLET-MARTEL**  
05-950  
19.0 cm, 7 1/2"



**PRATT**



**PENNINGTON / SIEZING**



**CHAPUT**  
05-980  
13.0 cm, 5"



# DRESSING FORCEPS

Schwammzange  
Pinza para tapones

Pince pour éponges  
Pinza per tamponi e sponge

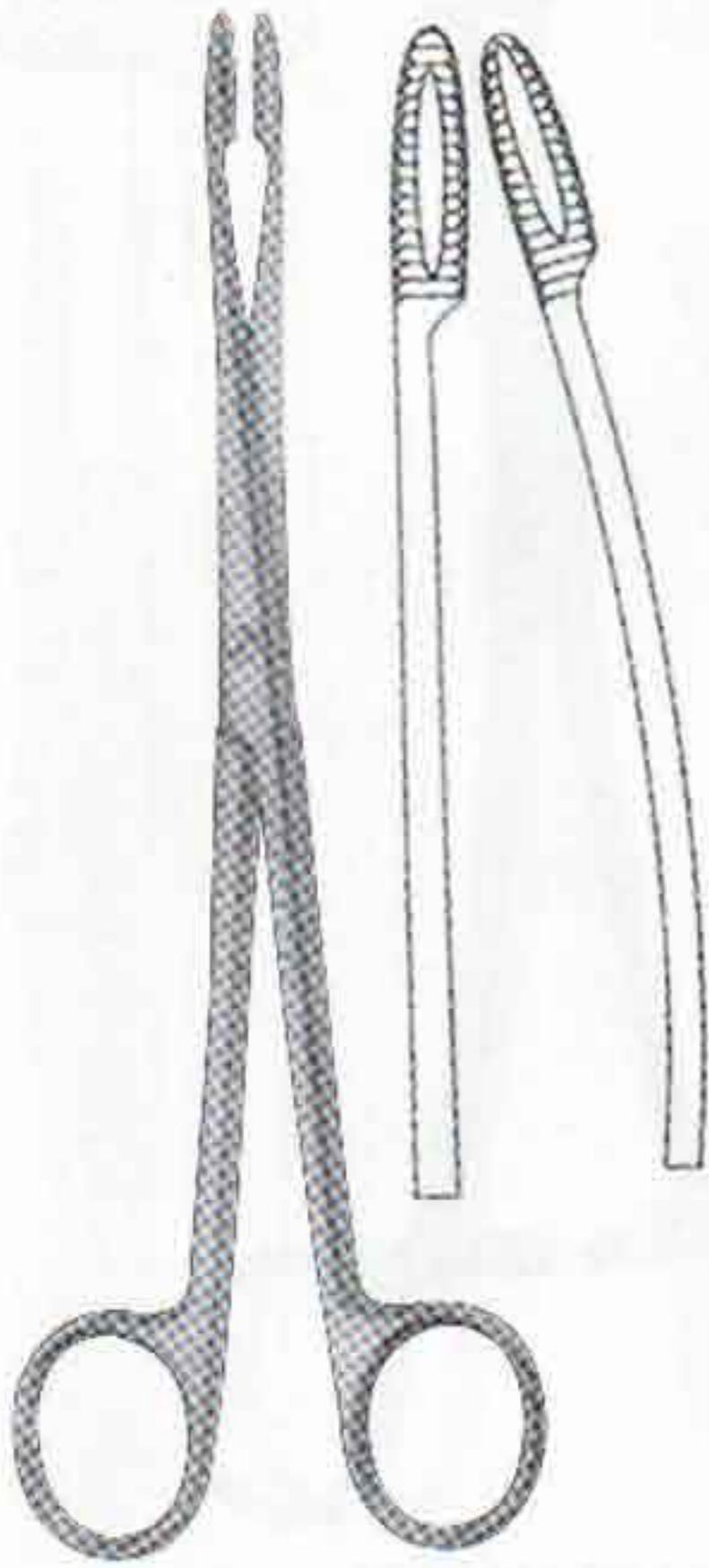

**GROSS**  
05-990 18cm, 7"  
05-991 20cm, 8"  
With Ratchet

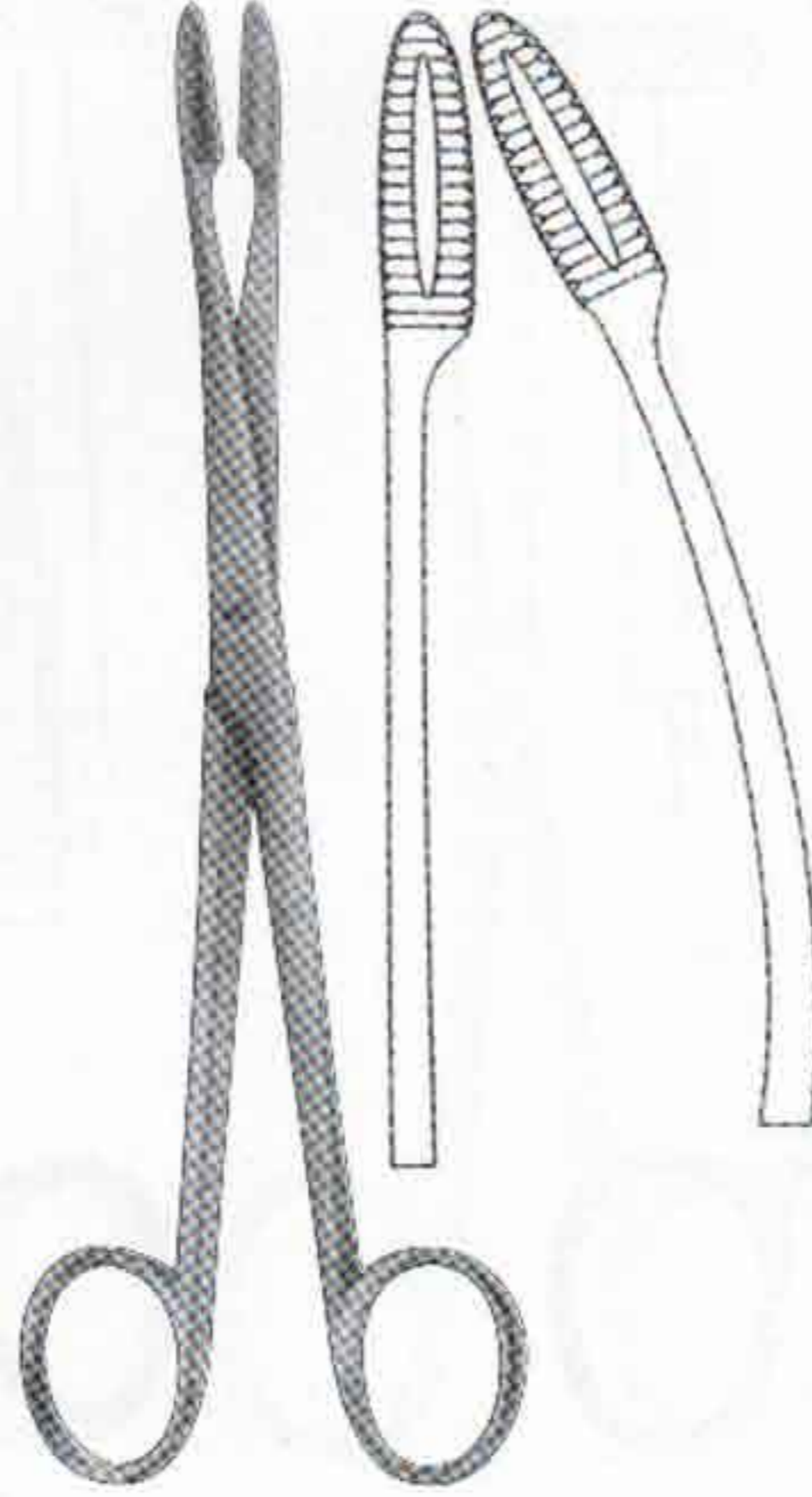

**GROSS**  
Without Ratchet  
05-1000  
20cm, 8"

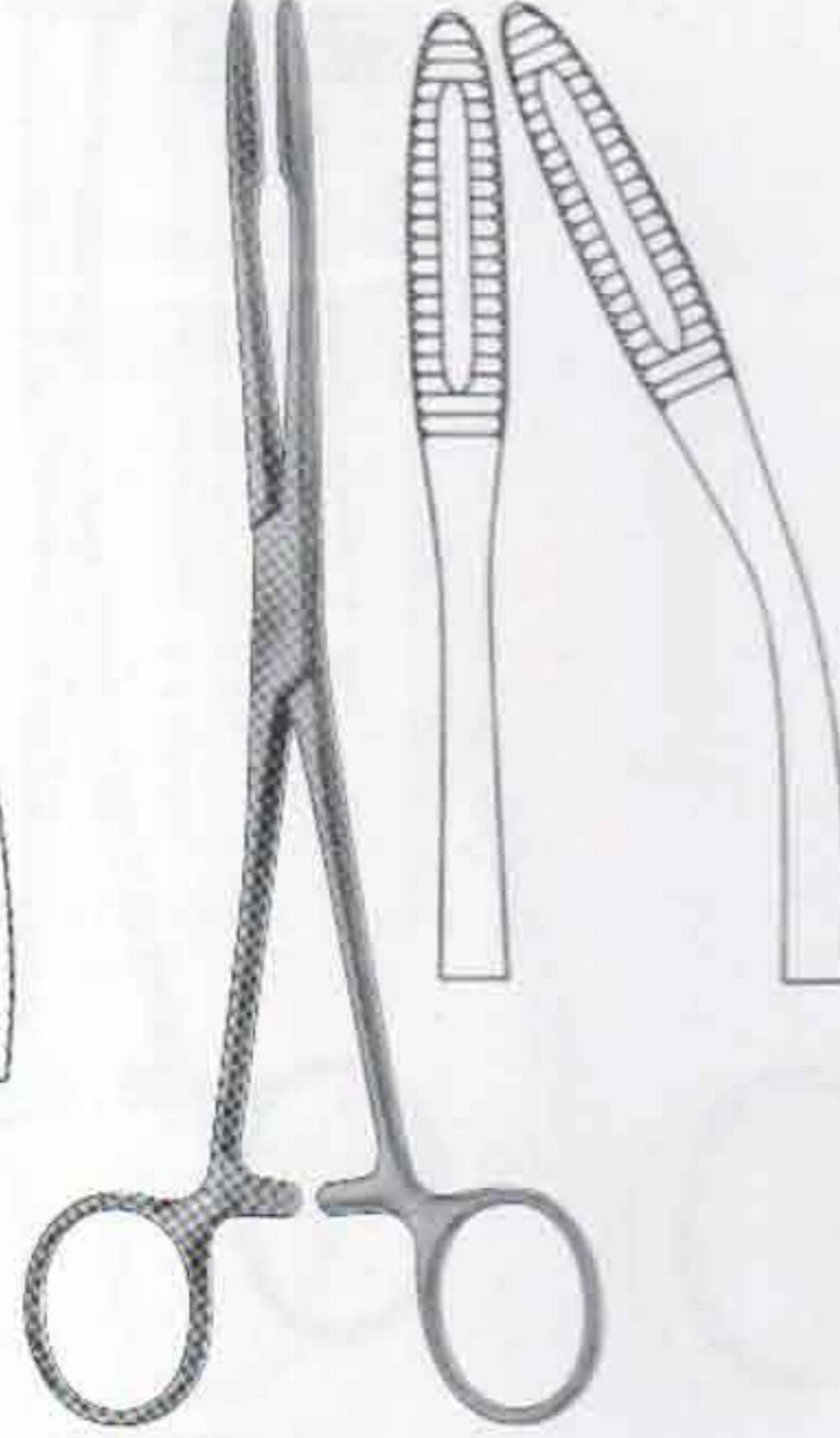

**GROSS**  
With Ratchet  
05-1010  
20cm, 8"

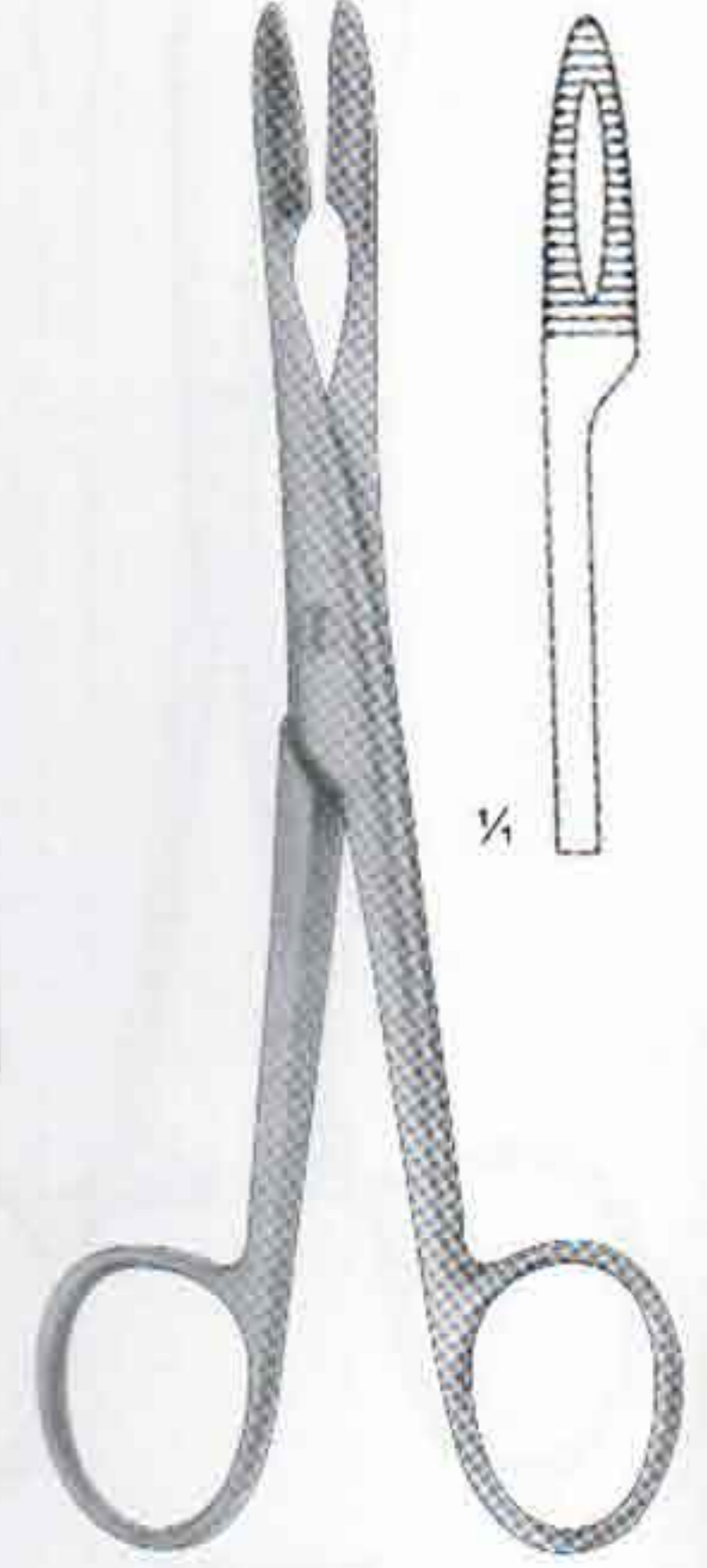

With Ratchet  
05-1020  
14.5cm, 5 3/4"

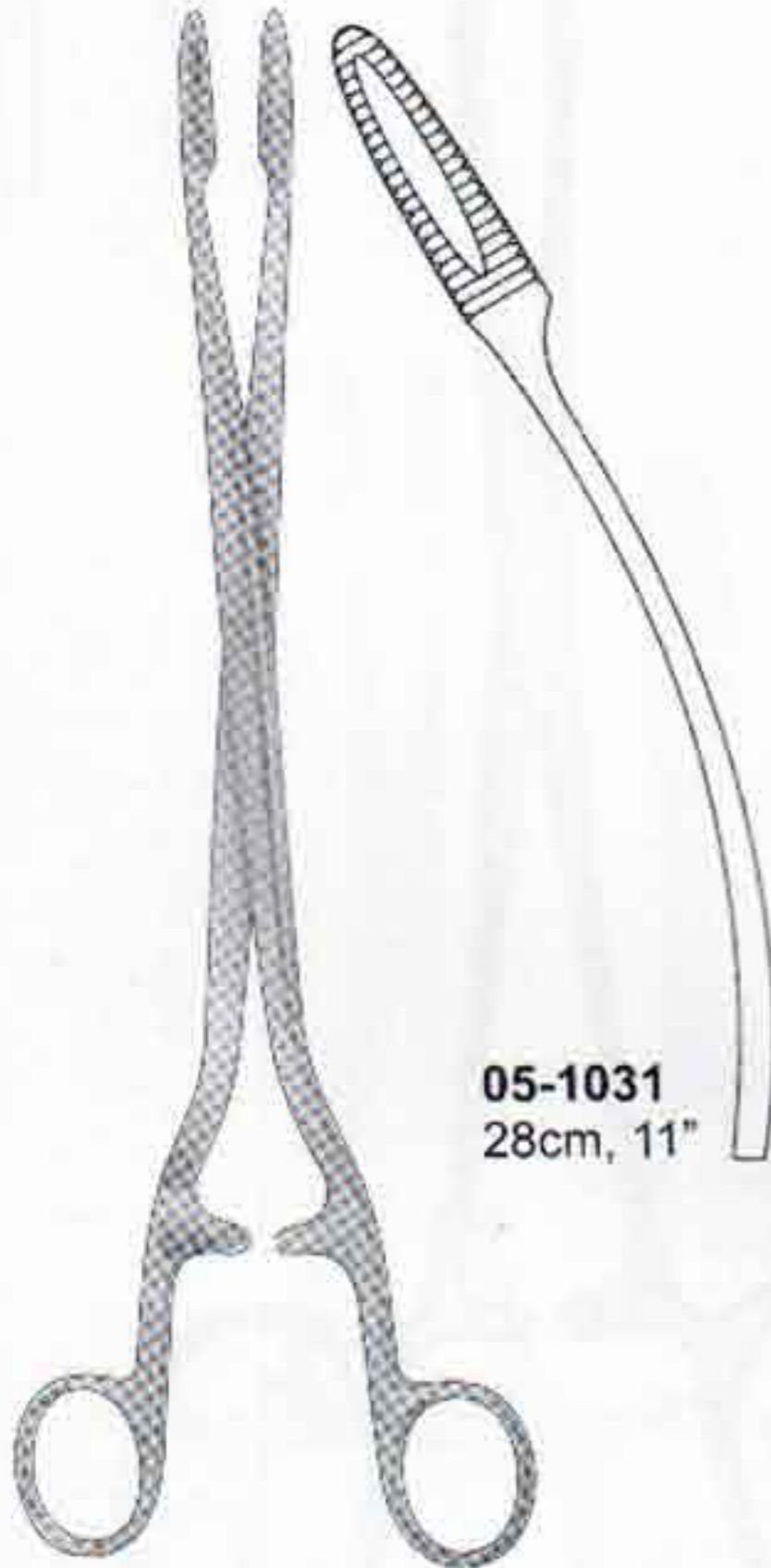

05-1031  
28cm, 11"

**SIMS-MAIER**  
05-1030  
28cm, 11"

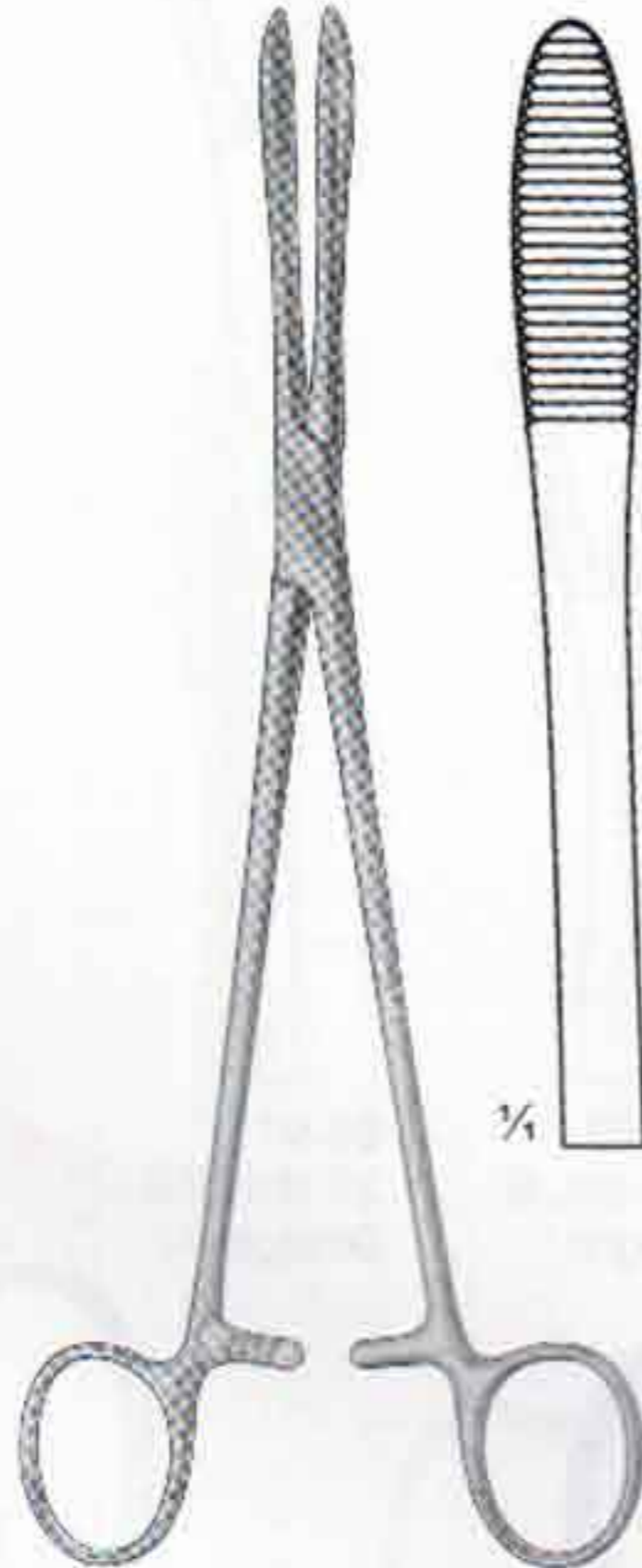

1/4"

**COLLIN**  
05-1040  
24cm, 9 1/2"

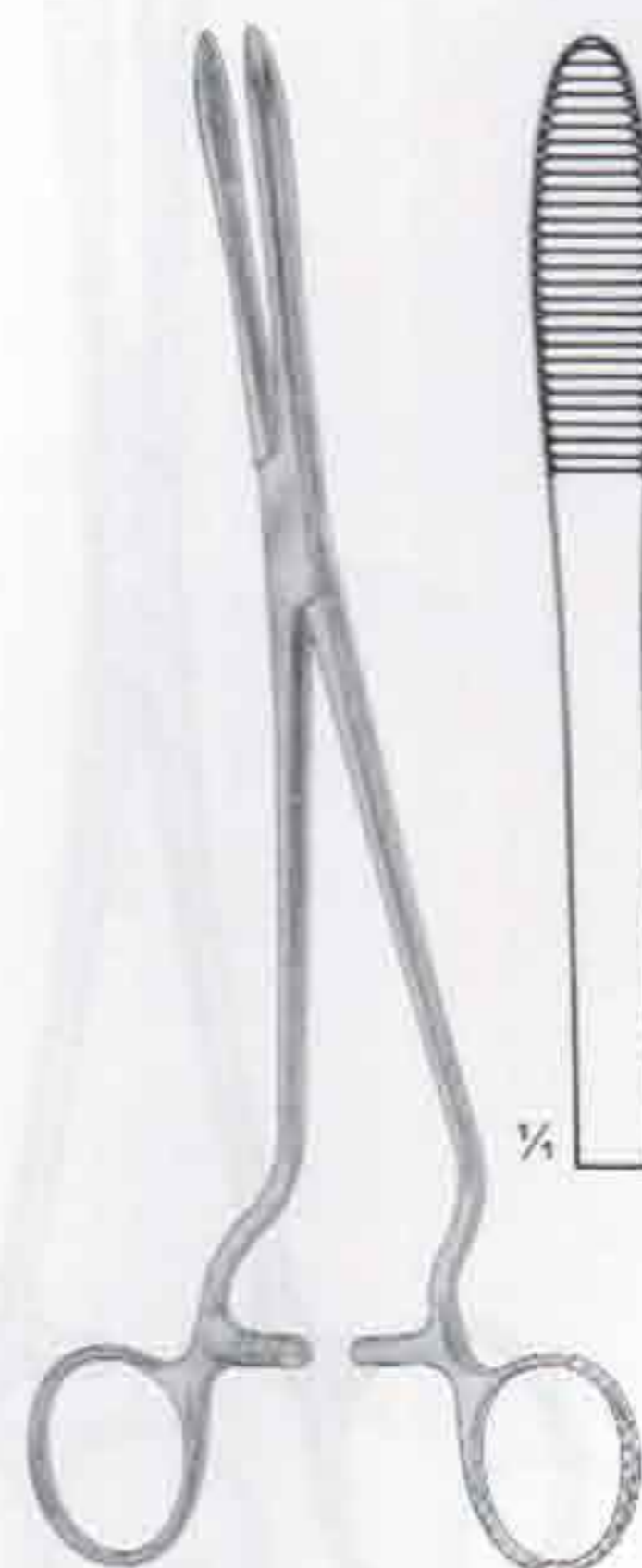

1/4"

**CHERON**  
Handles Laterally Angled  
05-1050  
24cm, 9 1/2"

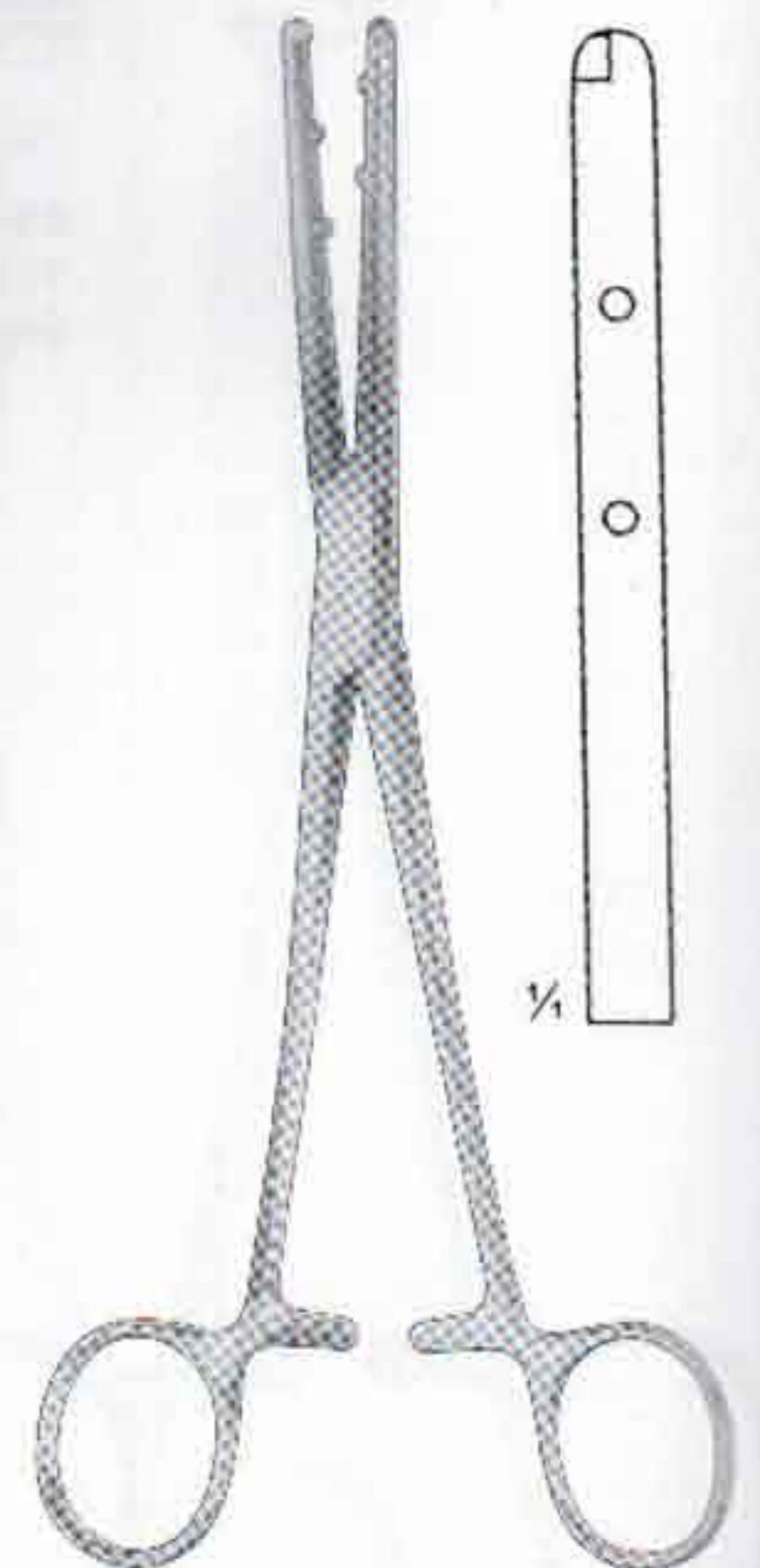

1/4"

**EMMET**  
05-1060  
21cm, 8 1/4"



# SPONGE FORCEPS

Schwammzange  
Pinza para tapones

Pince pour éponges  
Pinza per tamponi e spunge

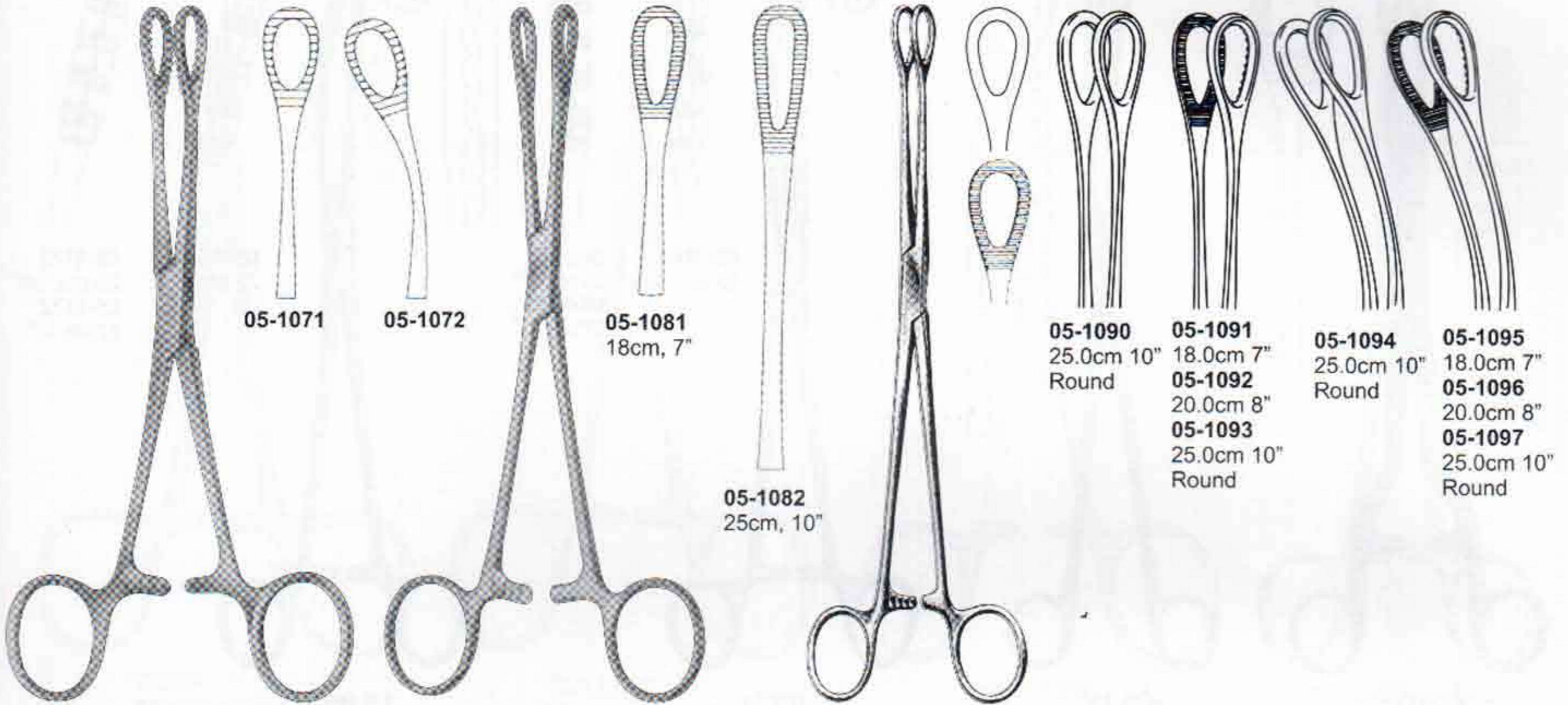

05-1071

05-1072

05-1081  
18cm, 7"

05-1082  
25cm, 10"

05-1090  
25.0cm 10"  
Round

05-1091  
18.0cm 7"

05-1092  
20.0cm 8"

05-1093  
25.0cm 10"  
Round

05-1094  
25.0cm 10"  
Round

05-1095  
18.0cm 7"

05-1096  
20.0cm 8"

05-1097  
25.0cm 10"  
Round

**FOERSTER-BALLENGER**  
05-1070  
18cm, 7"

**RAMPLEY**  
05-1080

**FOERSTER**

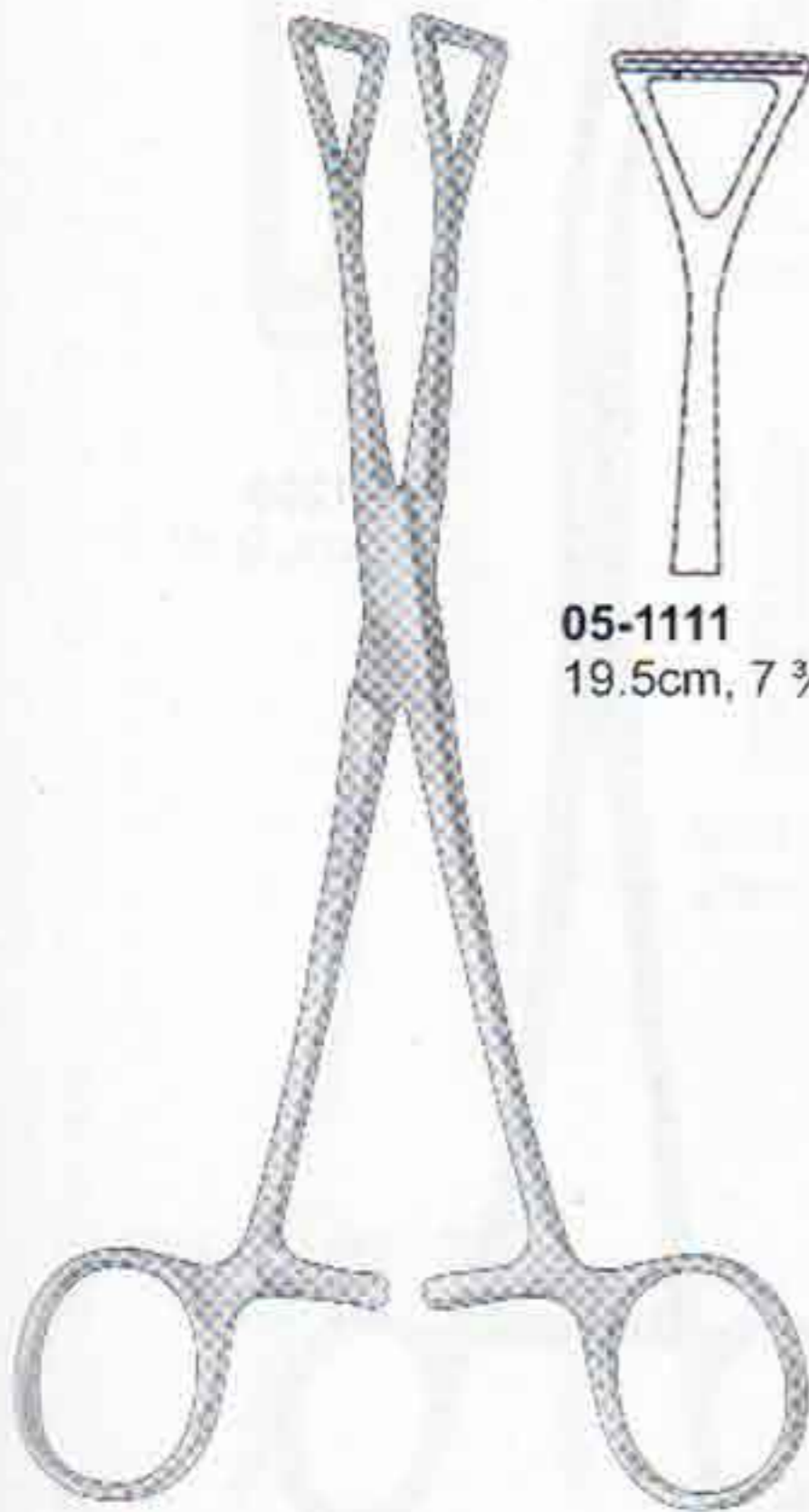

**COLLIN**  
05-1110

05-1111  
19.5cm, 7 3/4"

05-1112  
23cm, 9"

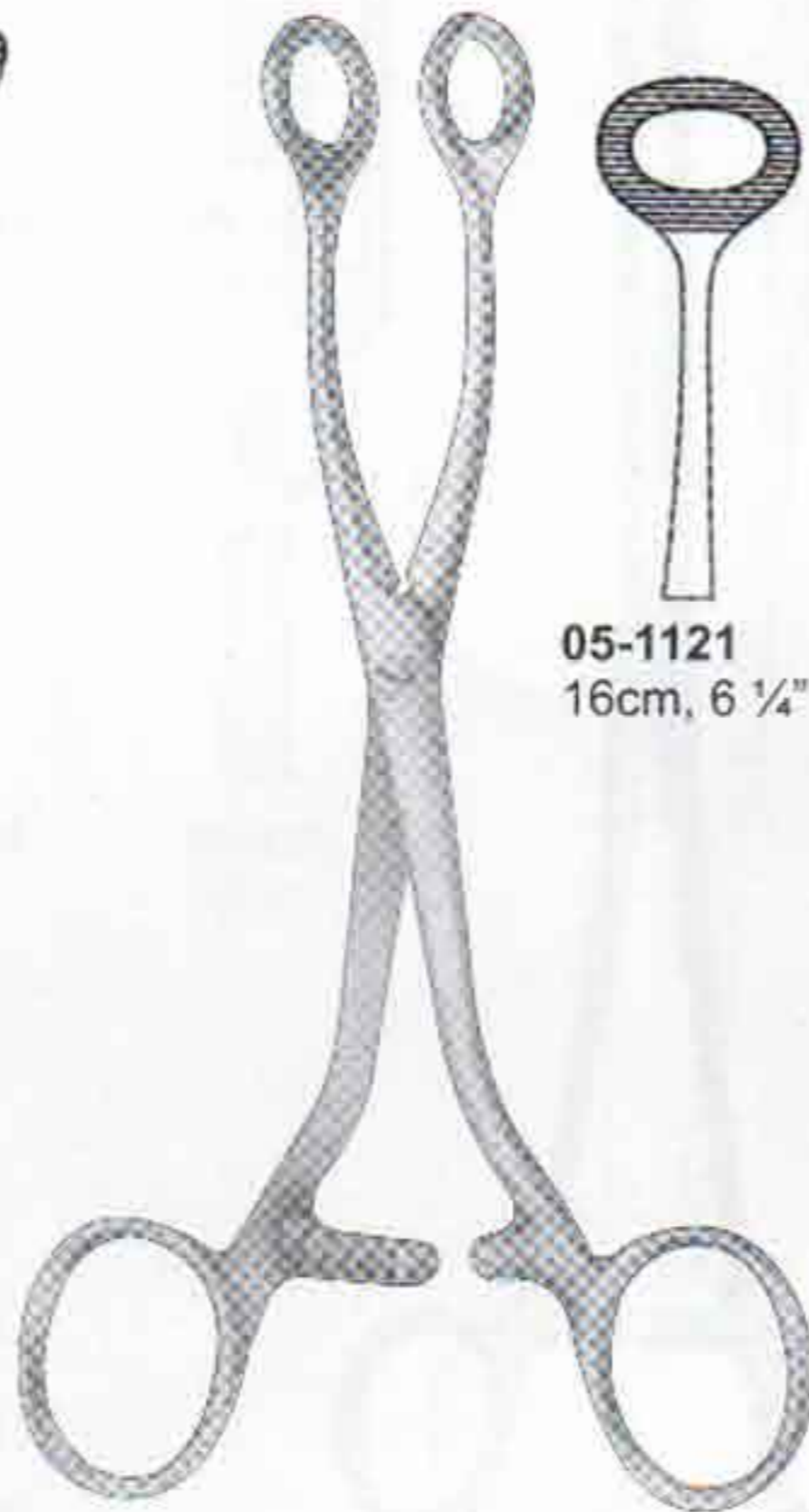

**COLLIN**  
05-1120

05-1121  
16cm, 6 1/4"

05-1122  
16cm, 6 1/4"

05-1123  
17cm, 6 3/4"

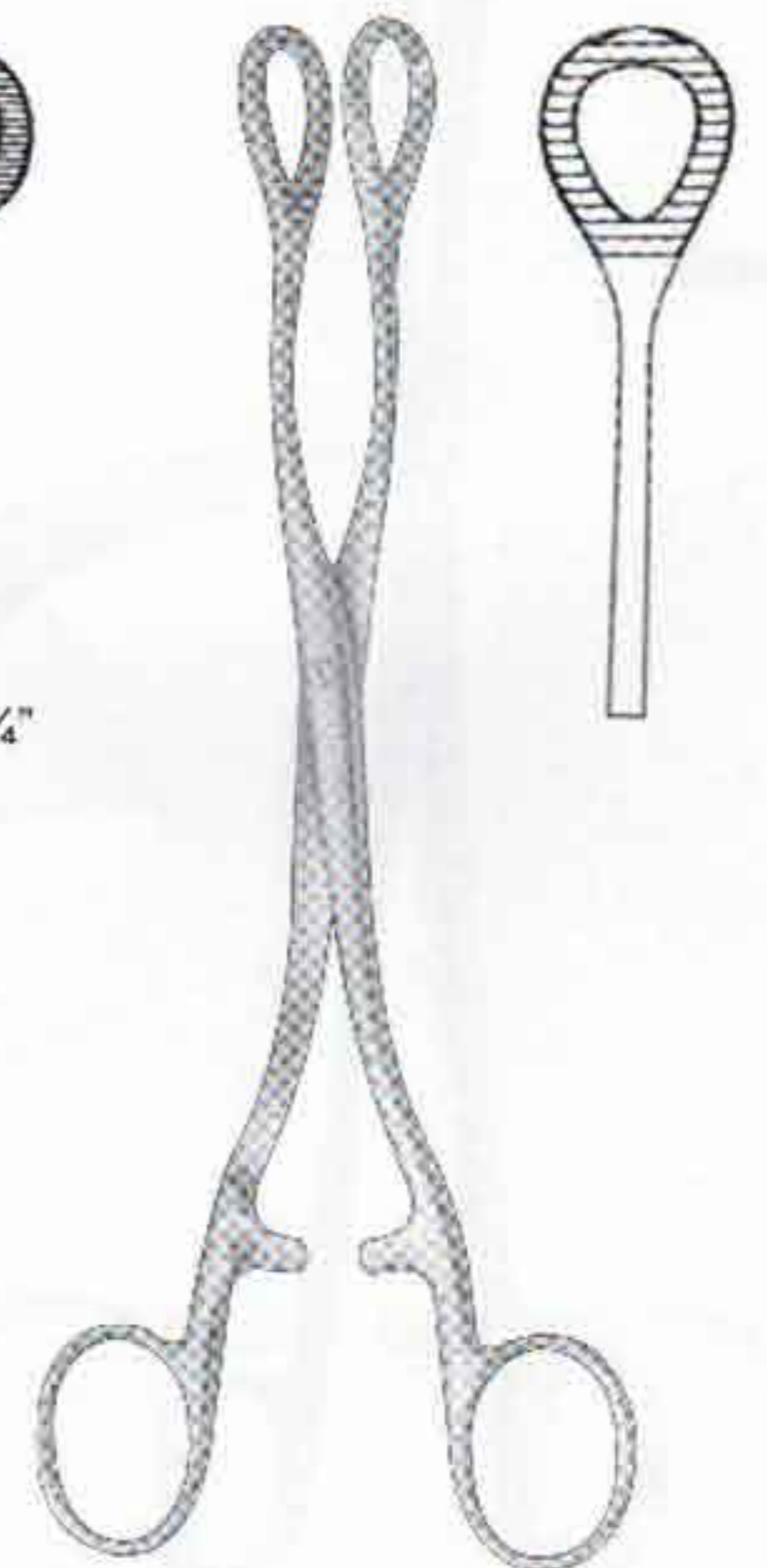

**HEYWOOD-SMITH**  
05-1130  
20cm, 8"



# SPONGE & DRESSING FORCEPS

Anatomische pinzetten, Schwammzange  
Pinzas de disección, Pinza para tapones

Marteaux-percuteurs, Pince pour éponges  
Pinze per dissezione, Pinza per tamponi e sponge

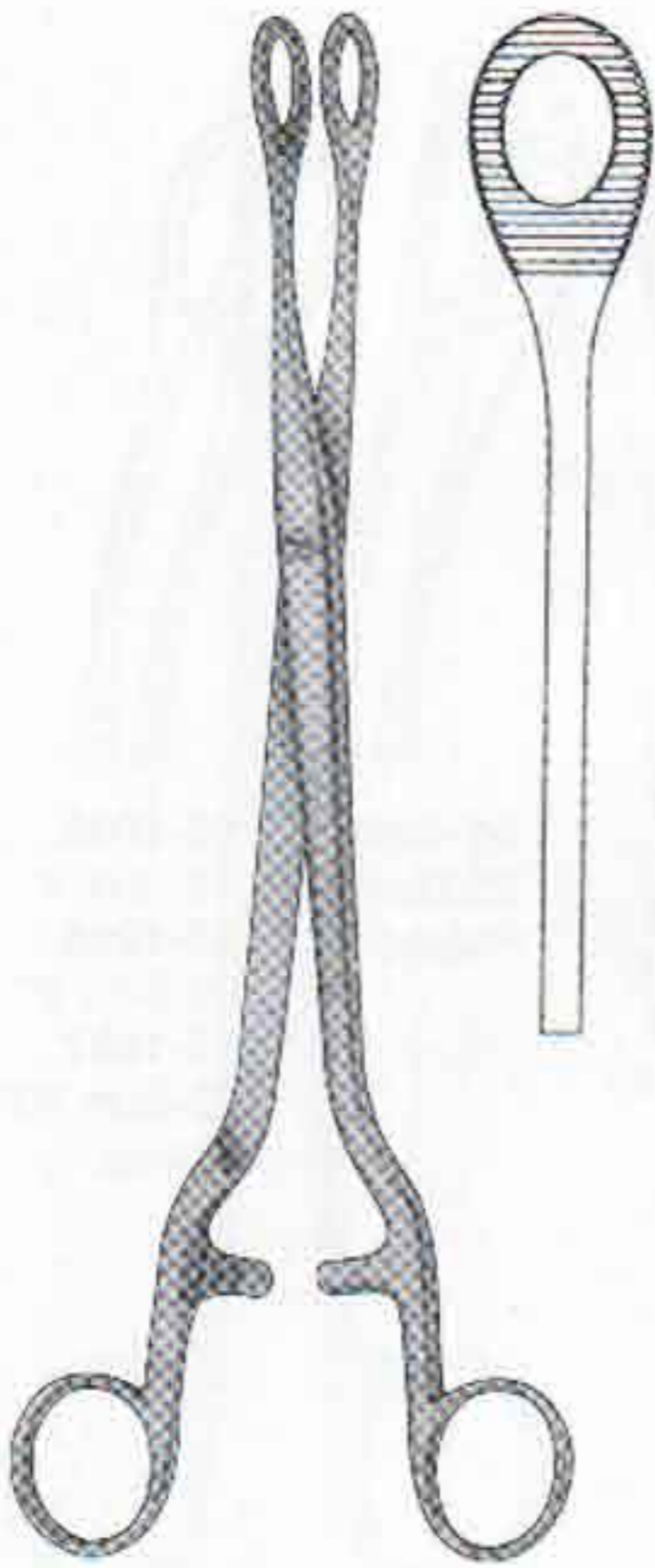

**NOTO**  
05-1140  
28cm, 11"

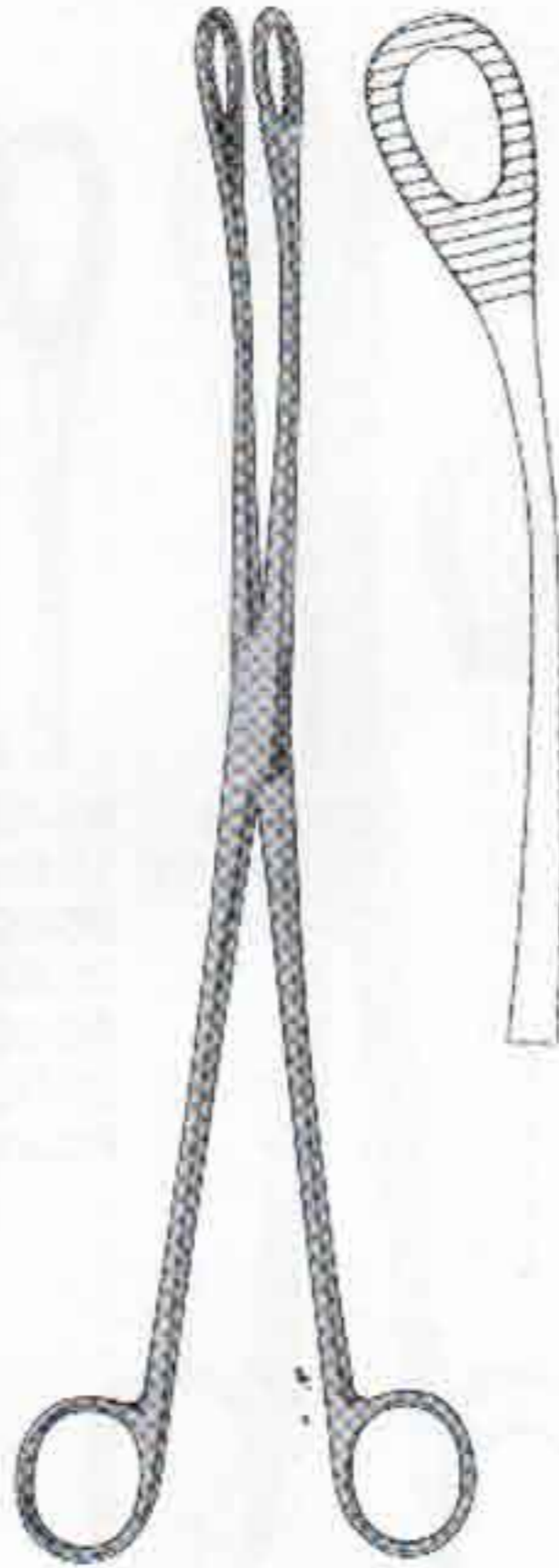

**KELLY**  
05-1150  
32Cm, 12 1/2"

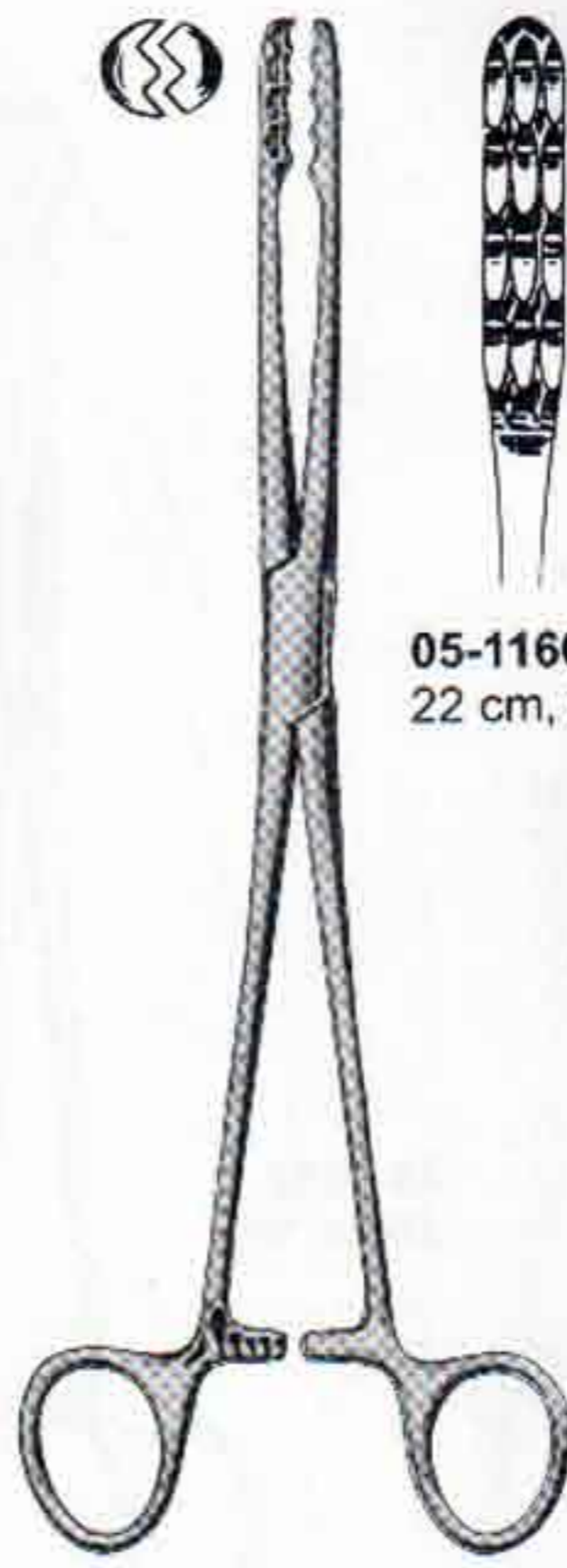

**ULRICH**

05-1160  
22 cm, 8 3/4"

05-1161  
25 cm, 10"  
05-1162  
27 cm, 11"



**ULRICH**

05-1170  
22 cm, 8 3/4"

05-1171  
25 cm, 10"  
05-1172  
27 cm, 11"



**HEYWOOD SMITH**  
05-1180  
25 cm, 10"



**FLETCHER**

05-1190  
24 cm, 9 1/2"



**FLETCHER**

05-1200  
24 cm, 9 1/2"



# NEEDLE HOLDERS

Nadelhalter  
Porta-agujas

Porte-agujas  
Portaghi

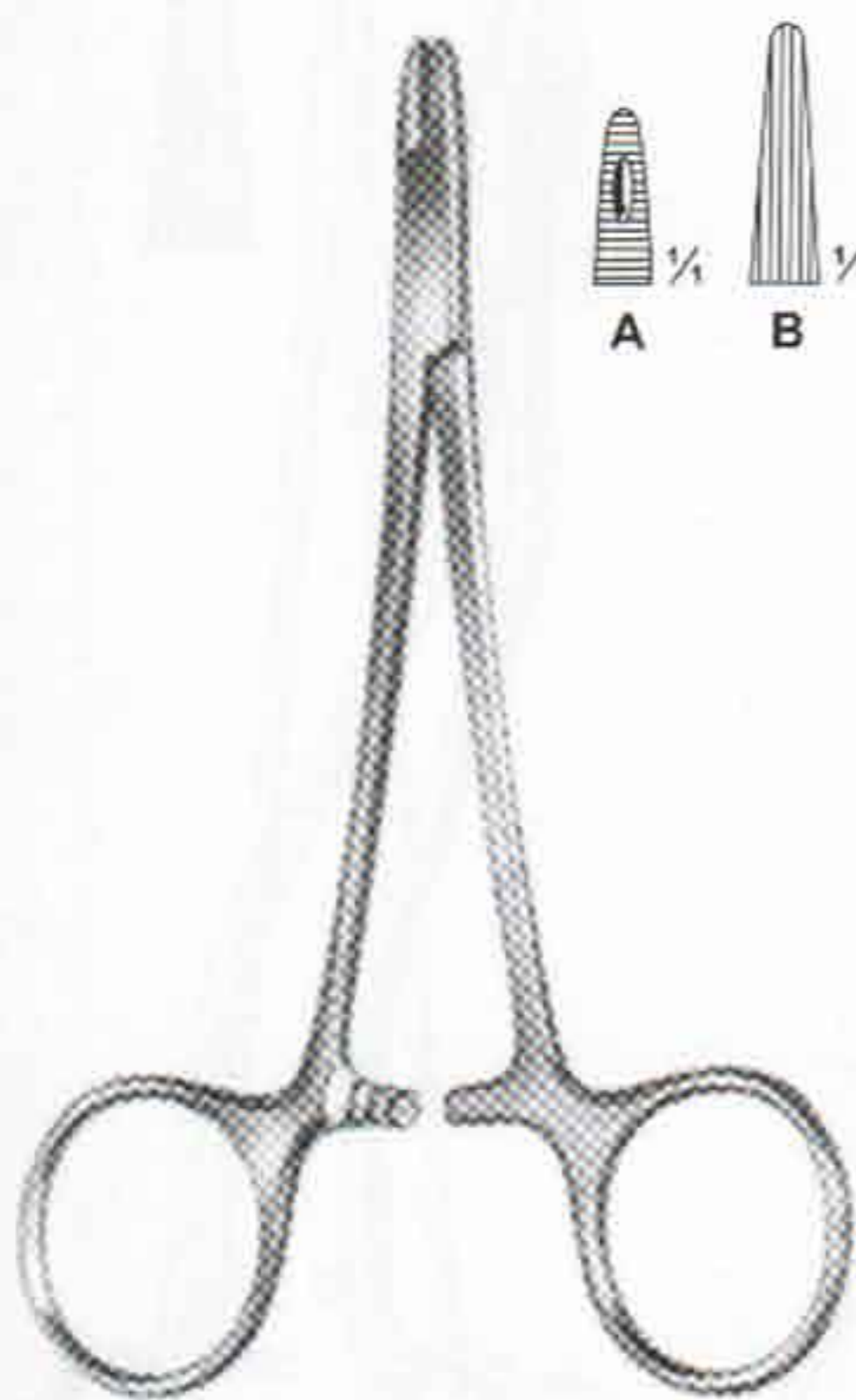

**DERF**  
06-100 12 cm, 5" A  
06-101 12 cm, 5" B



**COLLIER**  
06-110 12.5 cm



**WEBSTER**  
06-120 13cm



**M.G. HOSPITAL**

06-125  
17.5 cm  
Heavy  
pattern

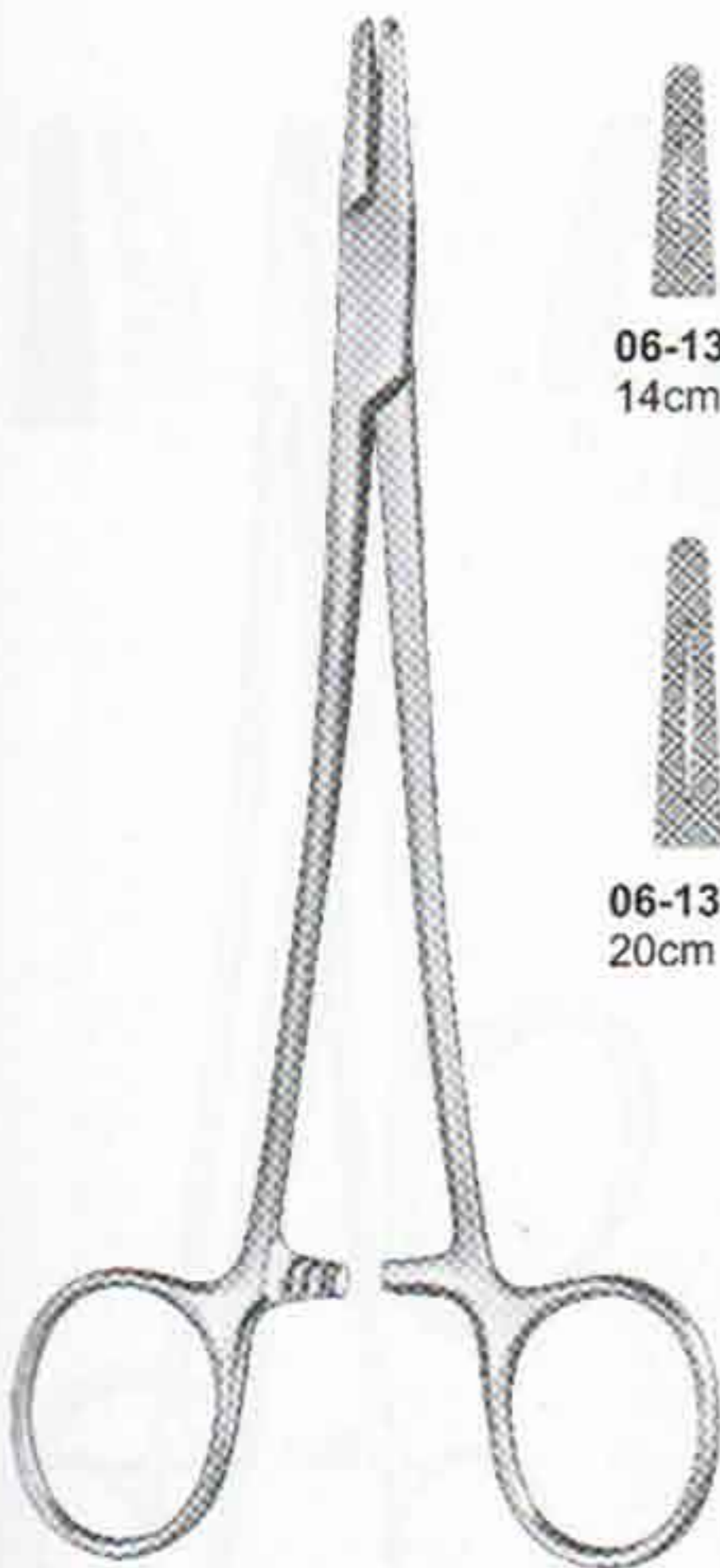

**MAYO-HEGAR**

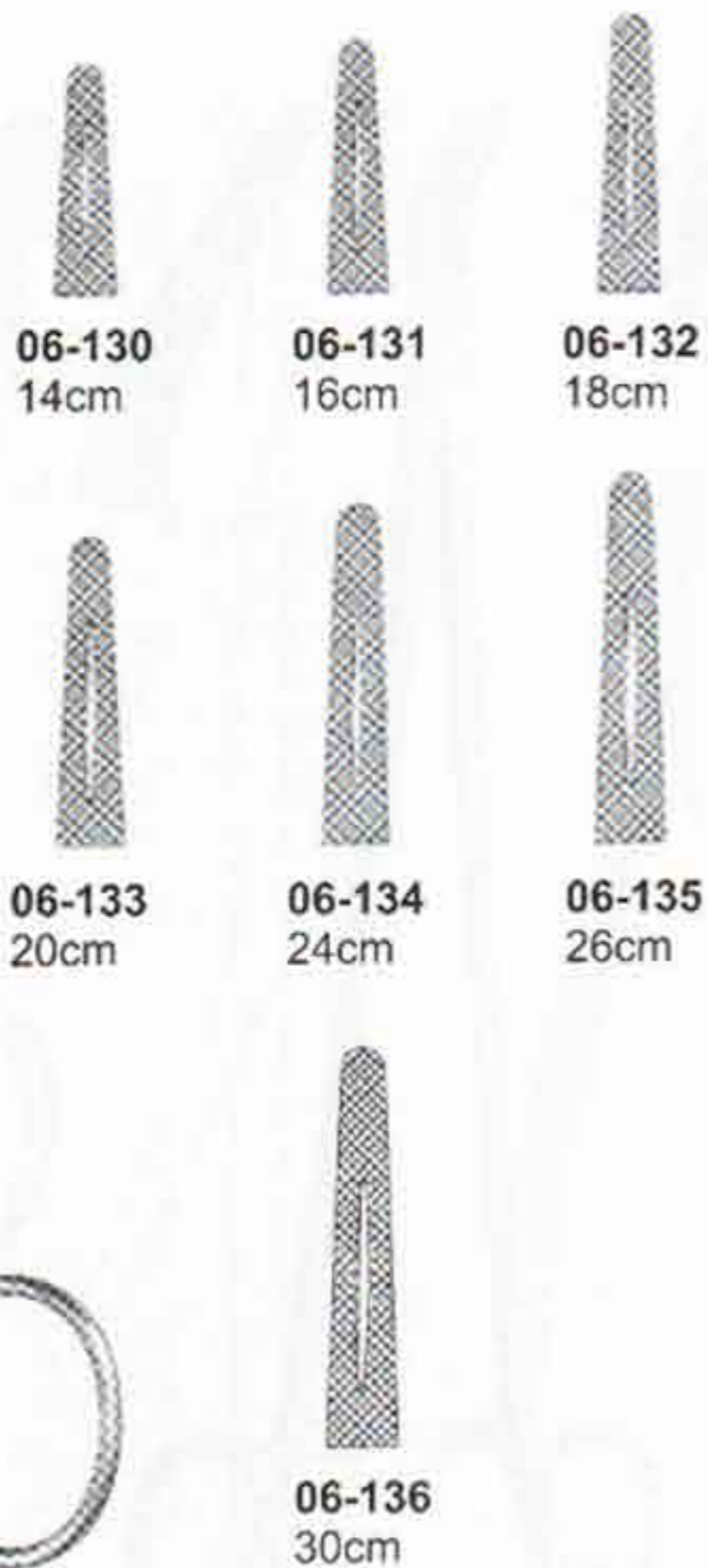

**CRILE-WOOD**  
06-140 150cm



**CRILE-MURRAY**  
06-150 15 cm

1/4  
Slender pattern



# NEEDLE HOLDERS

Nadelhalter  
Porta-agujas

Porte-agujas  
Portaghi

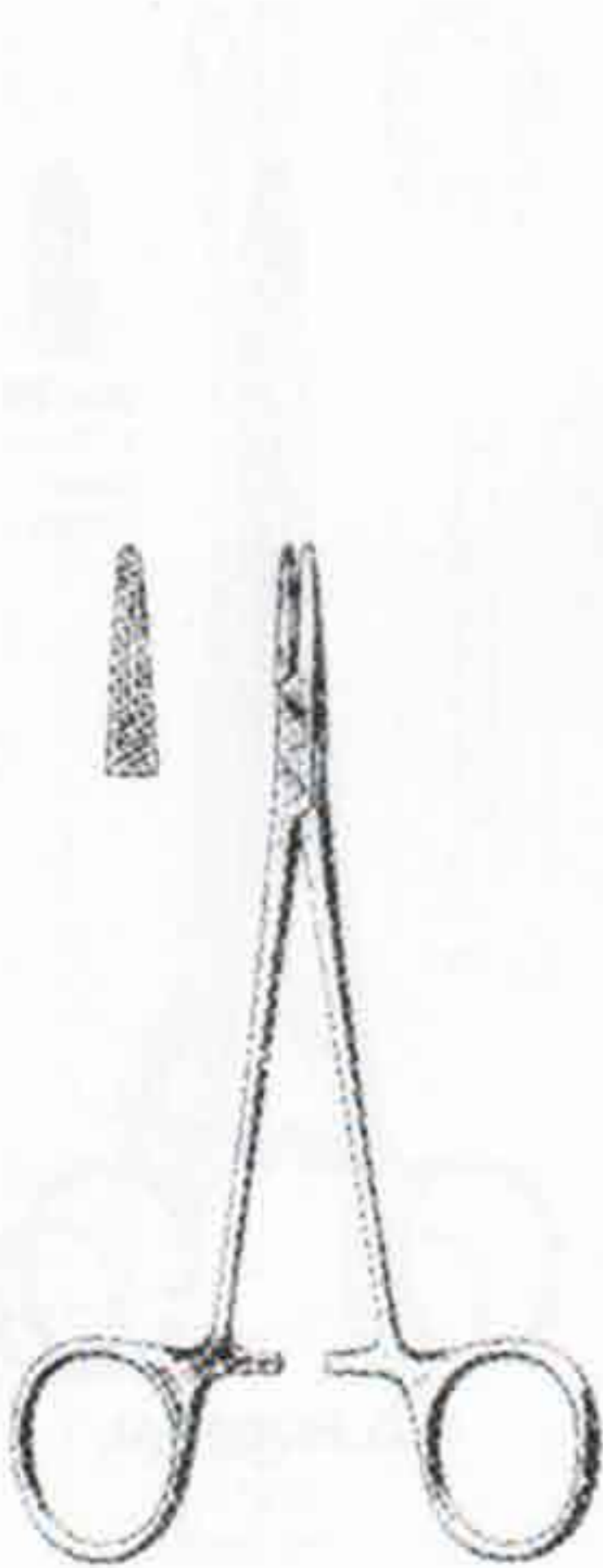

**WRIGHT**  
06-160 13cm

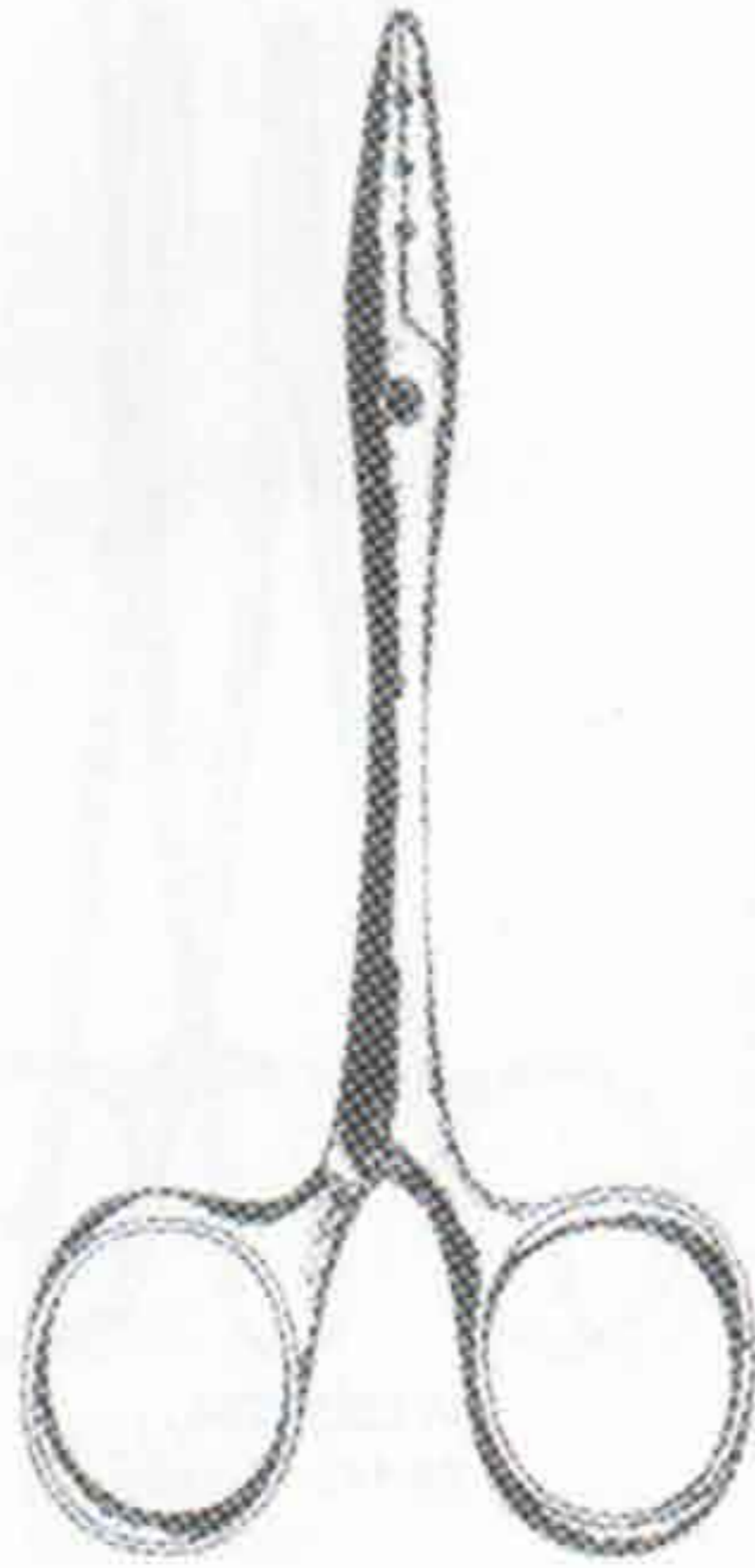

**BRUCE-CLARKE**  
06-170 12.5cm

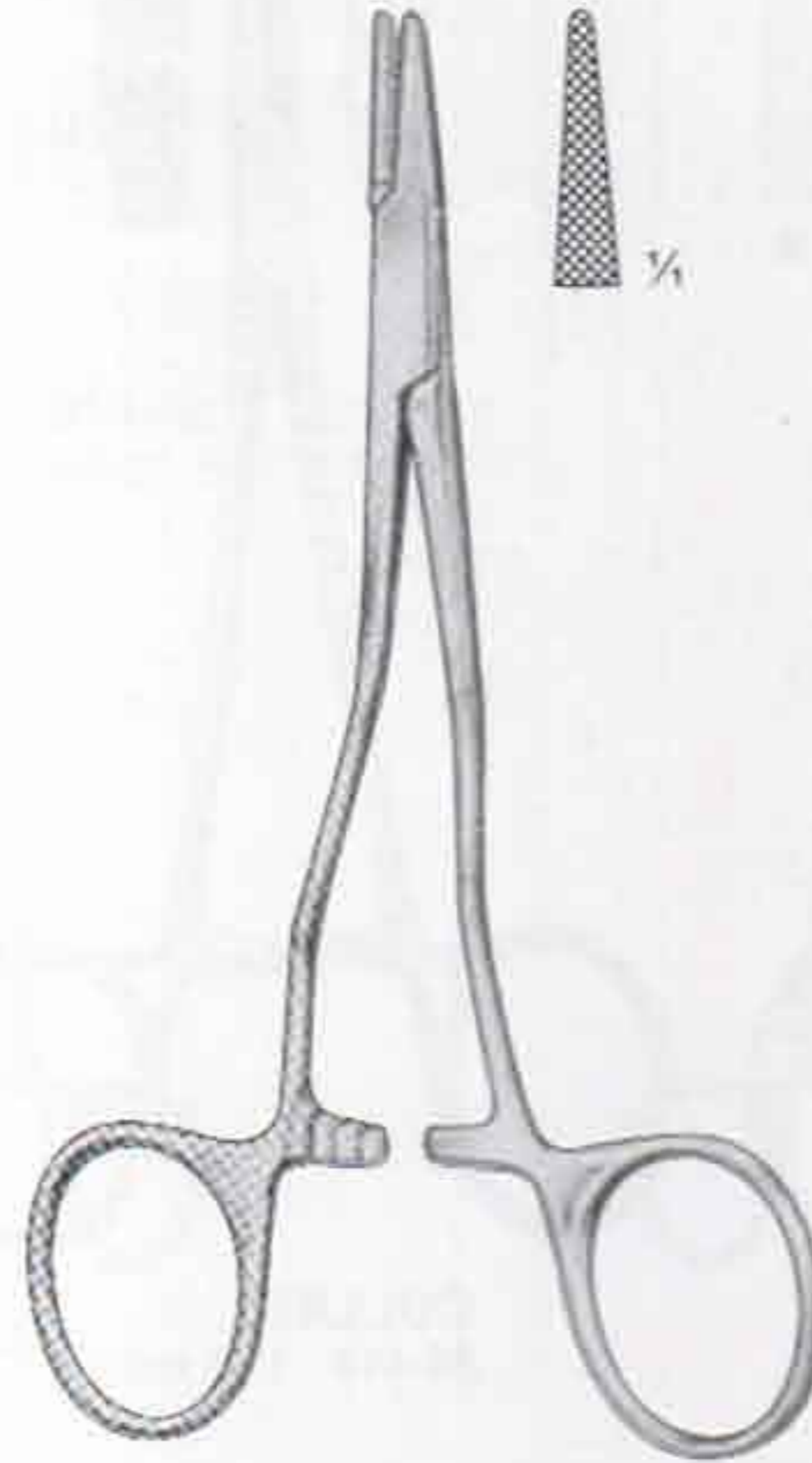

**KILNER**  
06-180 13.5 cm

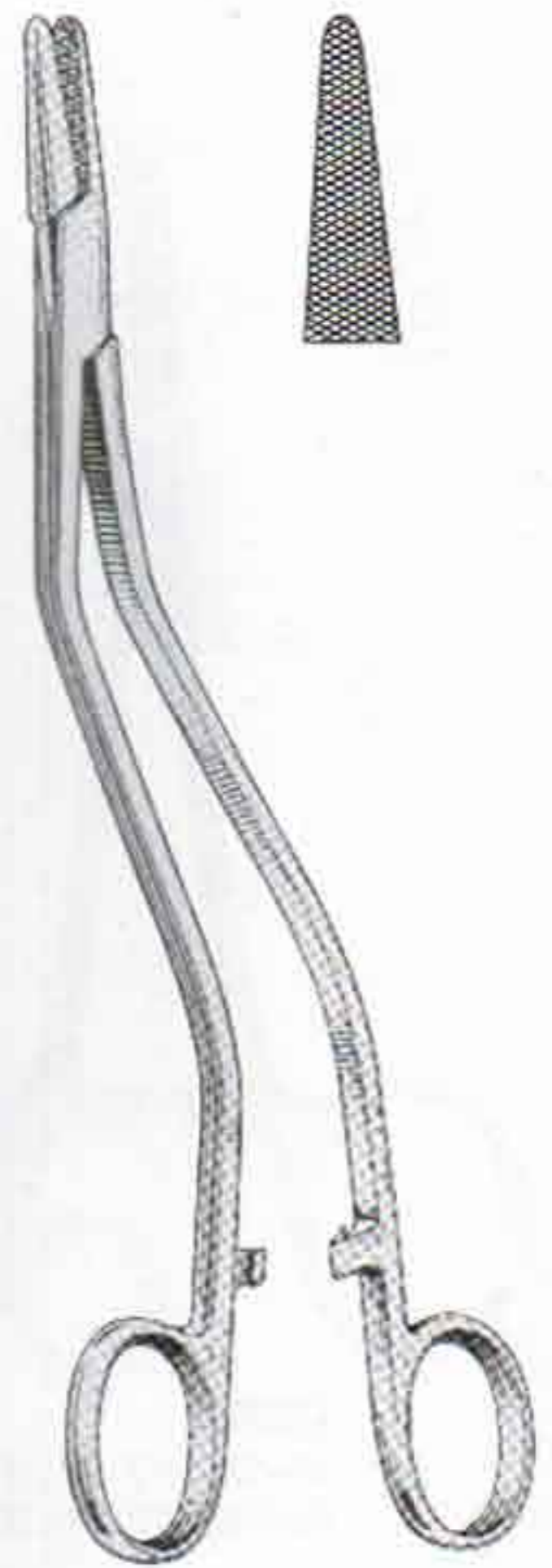

**THOMSON WALKER**  
06-190 20cm

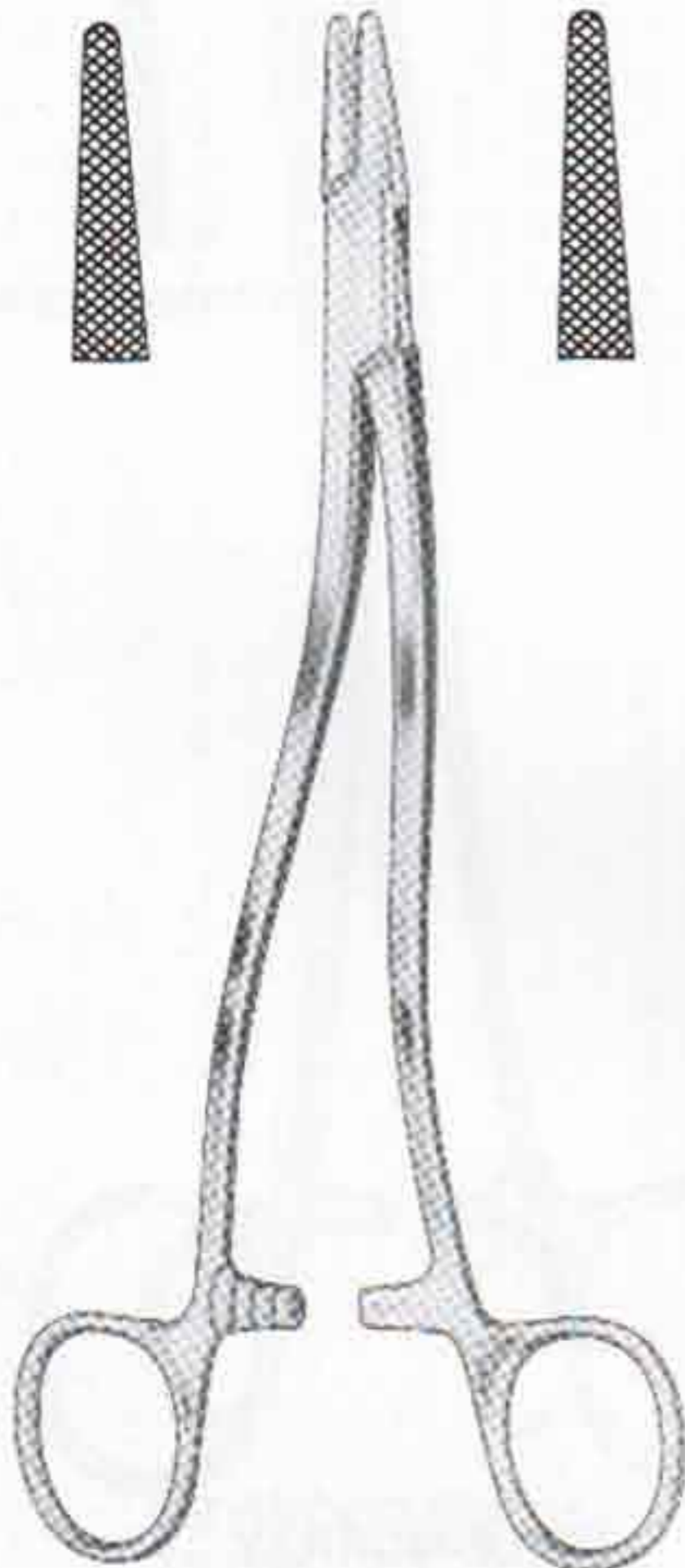

**BOZEMANN**  
06-200 20cm



**METZENBAUM**  
06-210 18cm



**FINOCCHIETTO**  
06-220 27cm



**WANGENSTEEN**  
06-230 27cm



# NEEDLE HOLDERS

Nadelhalter  
Porta-agujas

Porte-agujas  
Portaghi



**MASSON**  
06-240  
27 cm, 10 3/4"



**SAROT**  
06-250  
27cm



**OLSEN**

06-260 14cm 06-261 16.5 cm

06-262 19 cm

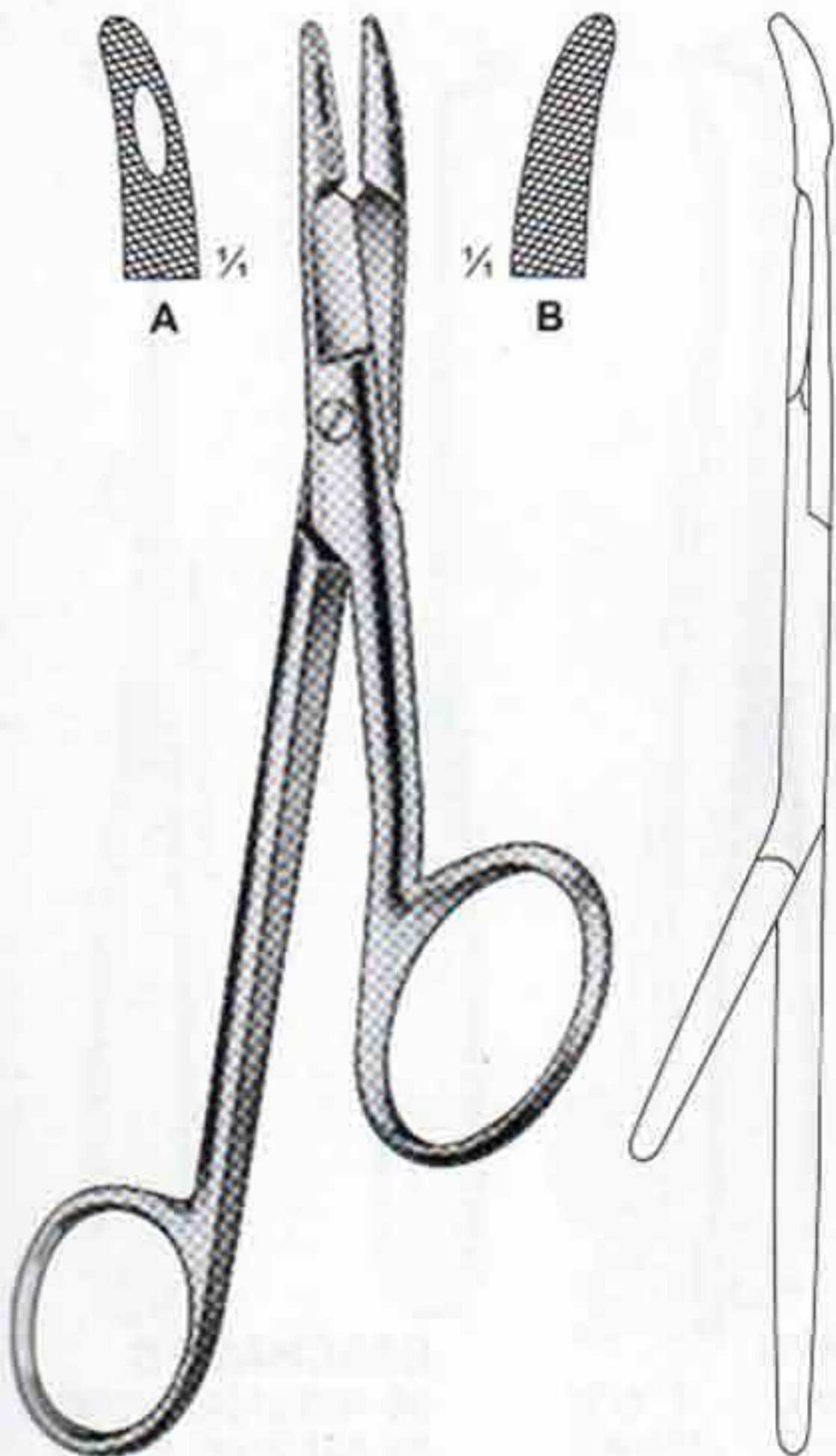

**GILLIES**  
06-270 16 cm



**MATHIEU**

06-280 11cm  
06-281 14cm  
06-282 17cm



**MATHIEU**

06-290 14cm  
06-291 17cm  
06-292 20cm  
06-293 24cm

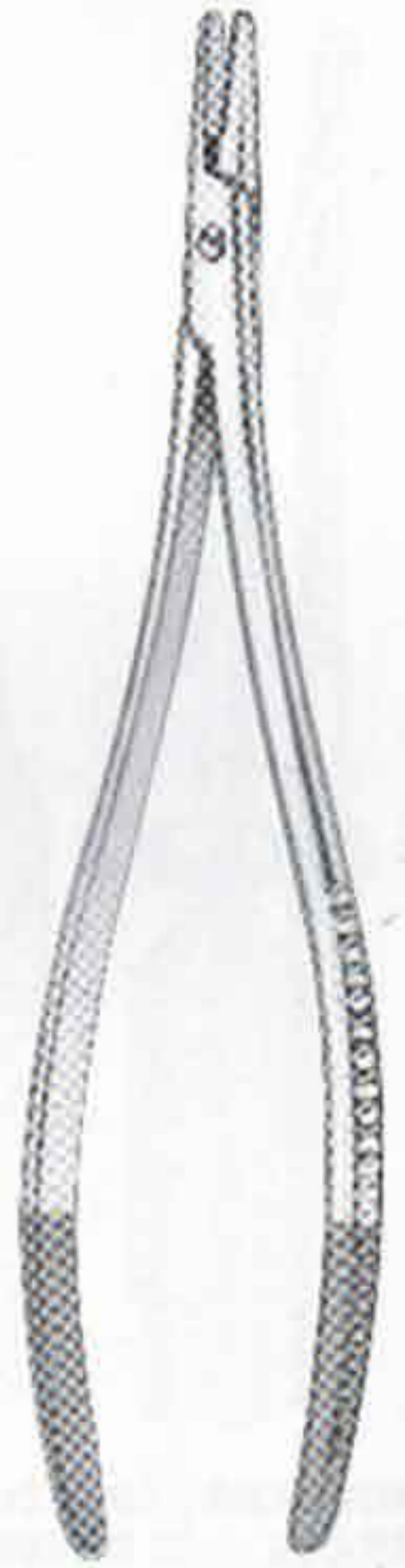

**LANGENBECK**  
06-300 18.5cm



# NEEDLE HOLDERS & LIGATURE NEEDLES

Nadelhalter, Unterbindungsnadeln  
Porta-agujas, agujas para ligaduras

Porte-agujas, Aiguilles à ligatures  
Portaghi, aghi di legatura



**CRILE**  
06-310  
15 cm, 6"

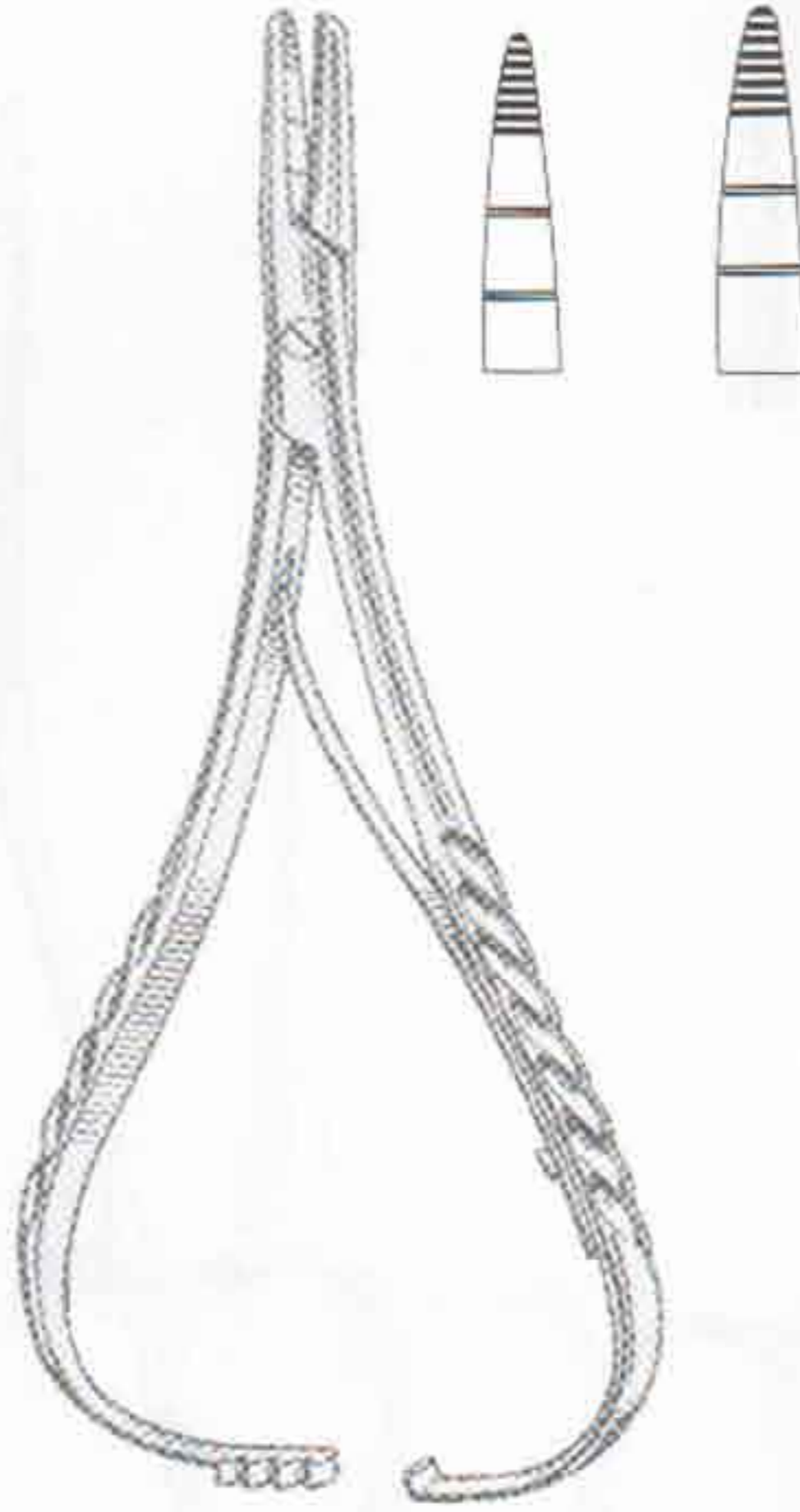

**MACPHAIL**  
06-320 14 cm  
06-321 16 cm  
06-322 18 cm  
06-323 20 cm

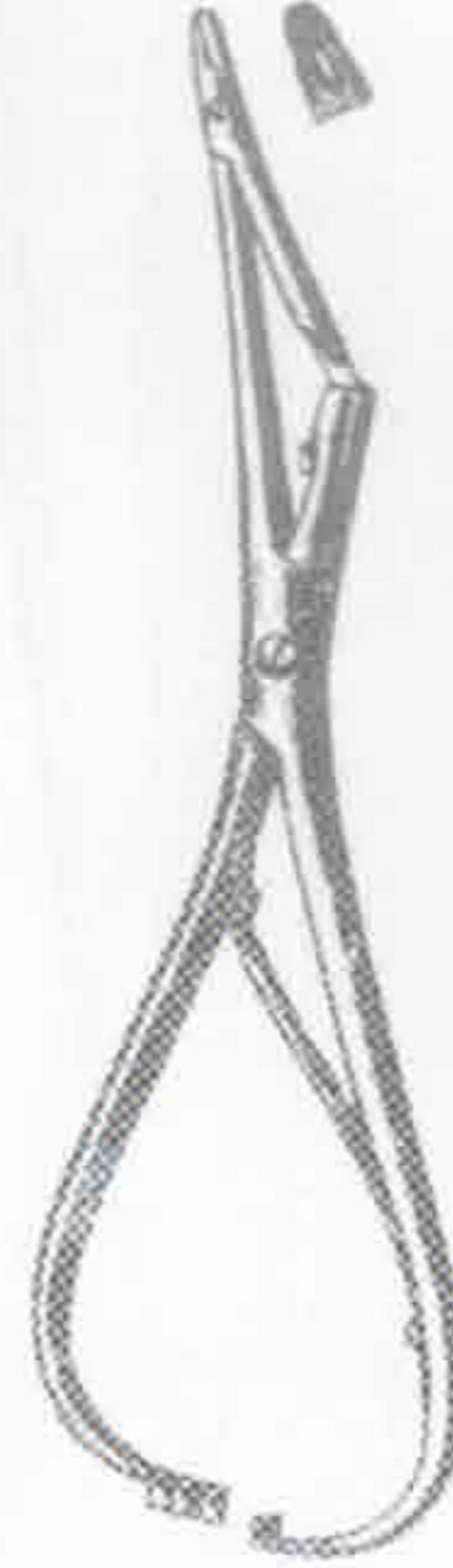

**HALSTEAD**  
06-330 16.5cm  
06-331 21cm  
06-332 24cm

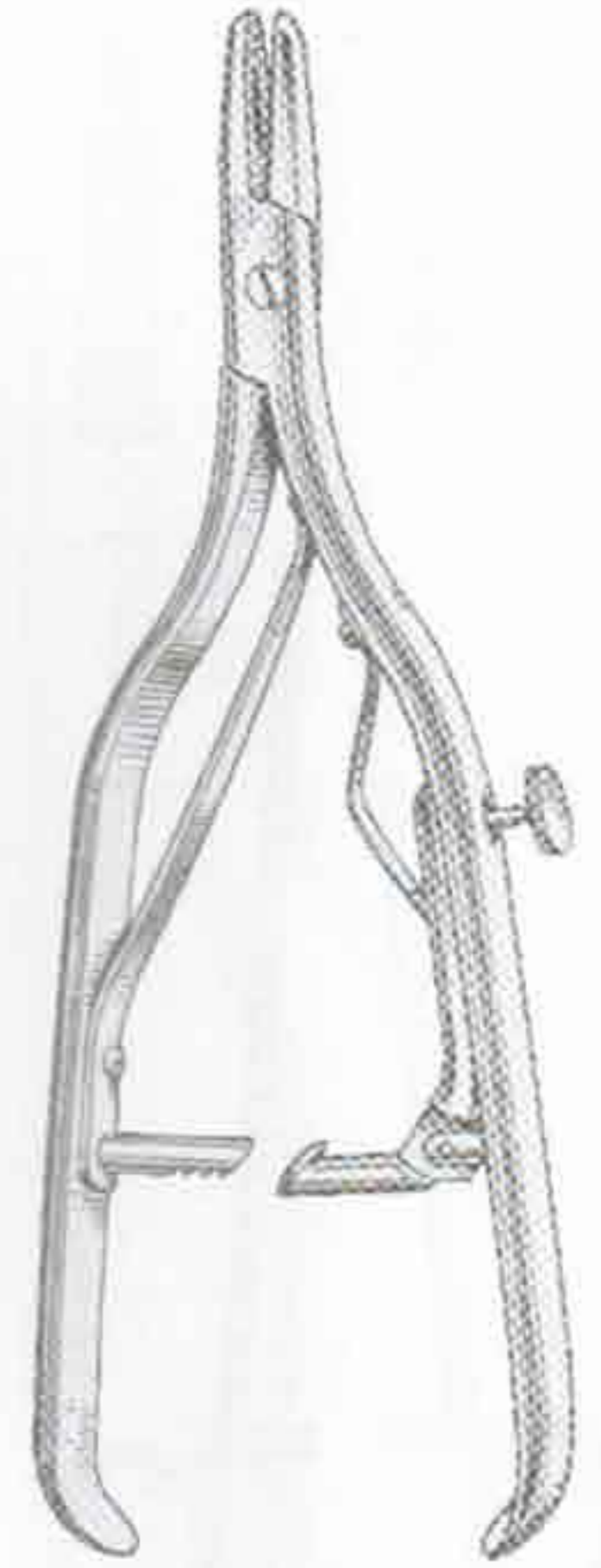

**ROCHESTER-MAYO**  
06-340 18 cm, 8"  
06-341 23 cm, 9"  
button release, screw joint.



**STEVENS**  
06-350  
13cm

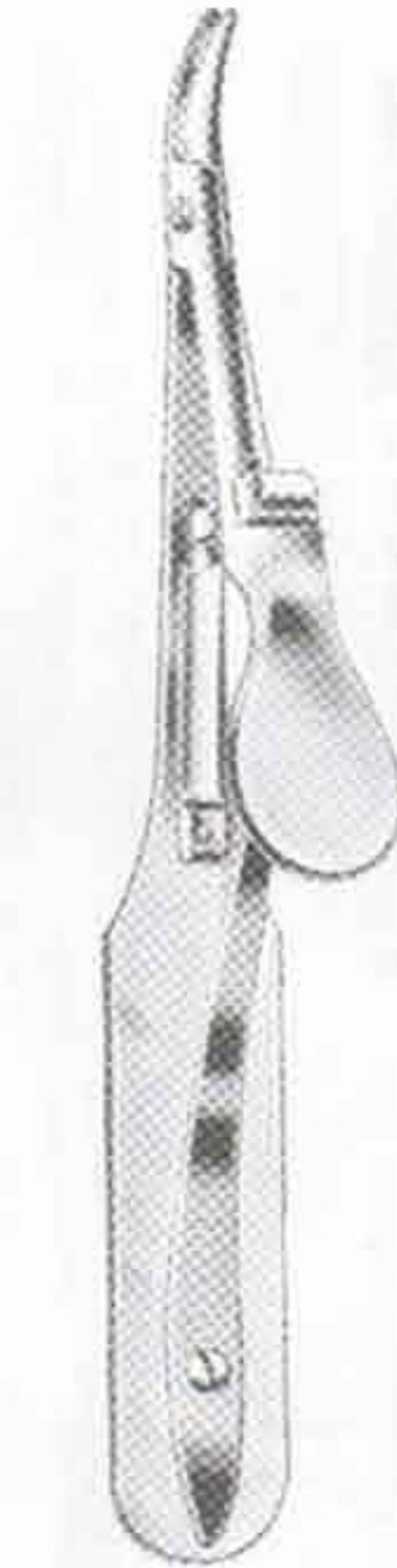

**KALT-ARRUGA**  
06-360 14cm



**KALT**  
06-370 14cm



**CASTROVIEJO**  
06-380 14cm

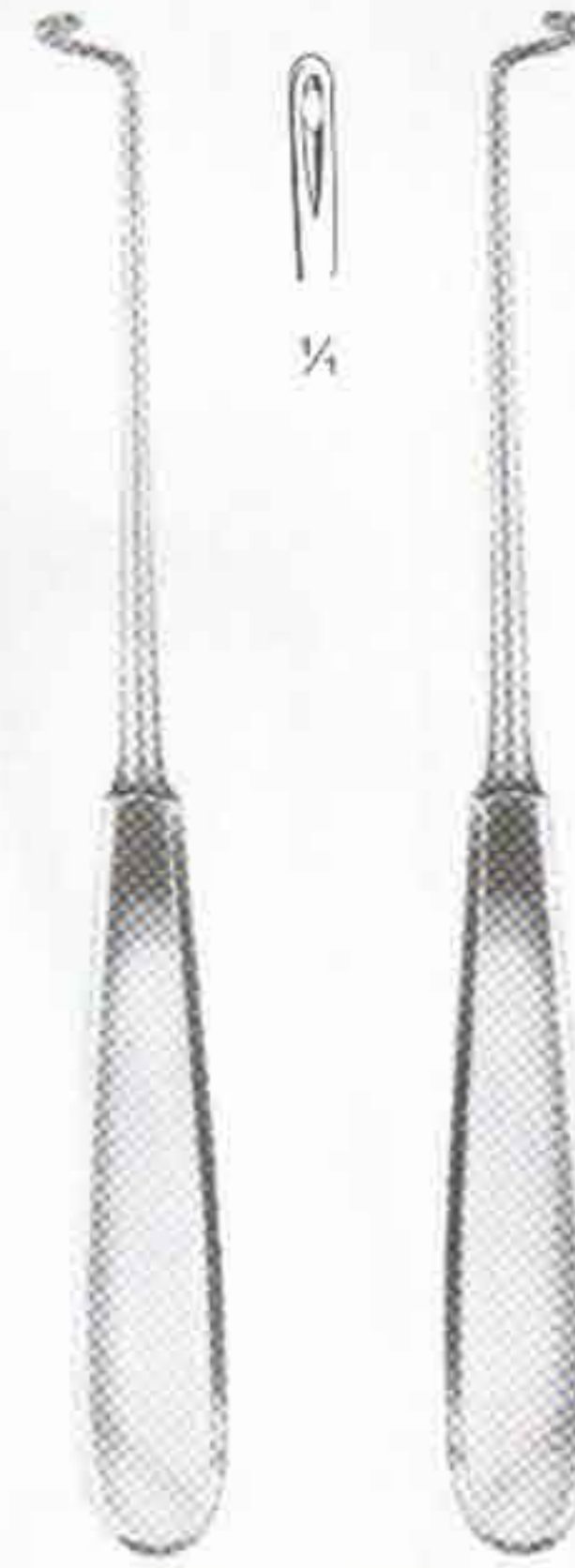

**DESCHAMPS**  
06-390 21cm L  
06-391 21cm R



**DESCHAMPS**  
06-400 21cm L  
06-401 21cm R



# REVERDIN NEEDLES

Reverdin nadeln  
aguja de reverdin

Aguilles de reverdin  
aghi di reverdin

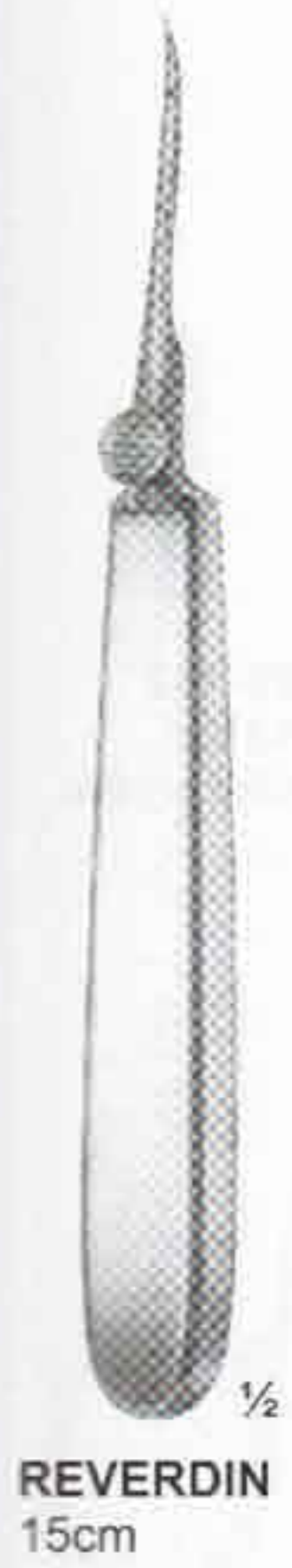

Fig. 1  
06-410 14.5cm

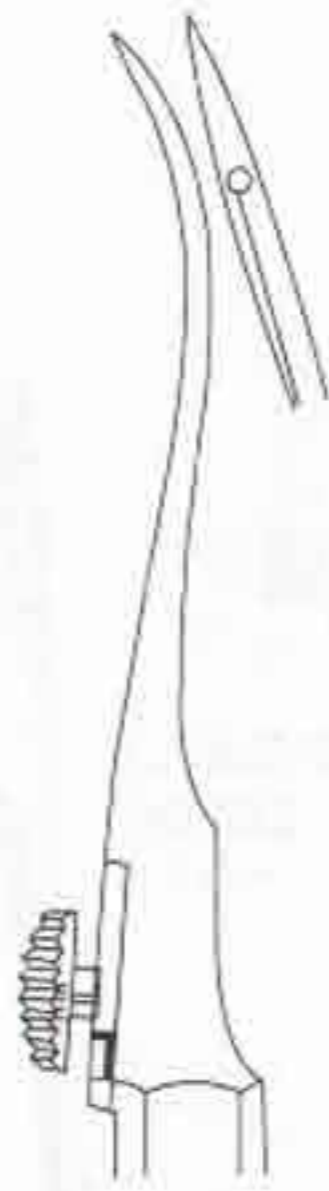

Fig. 2  
06-411 14.5cm

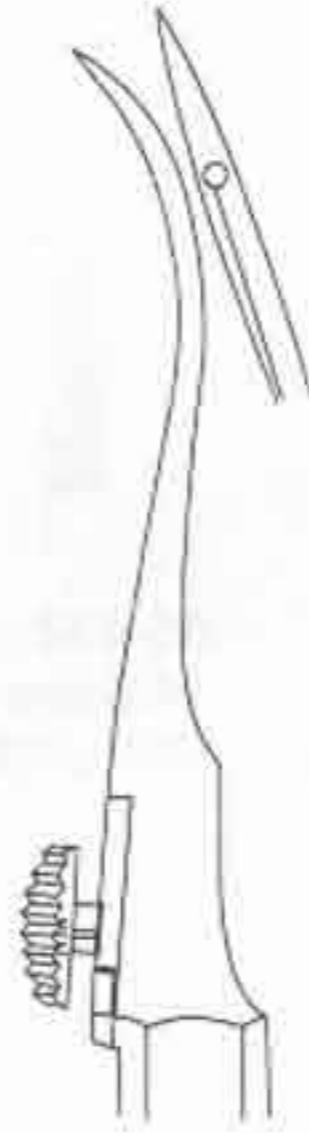

Fig. 3  
06-412 14.5cm

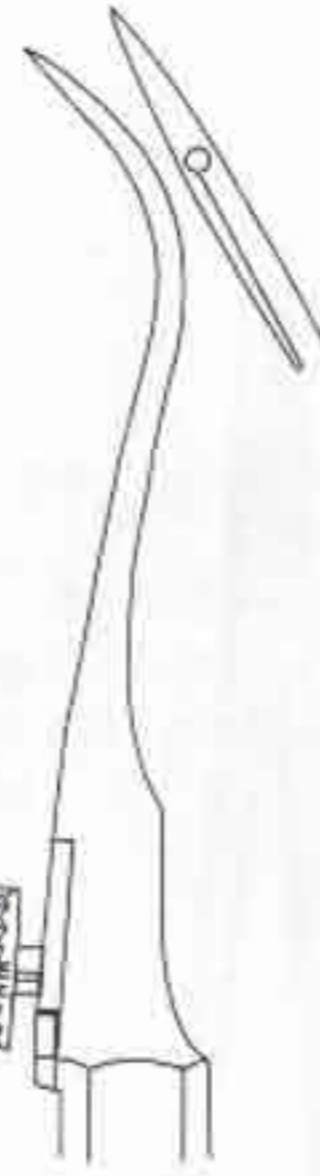
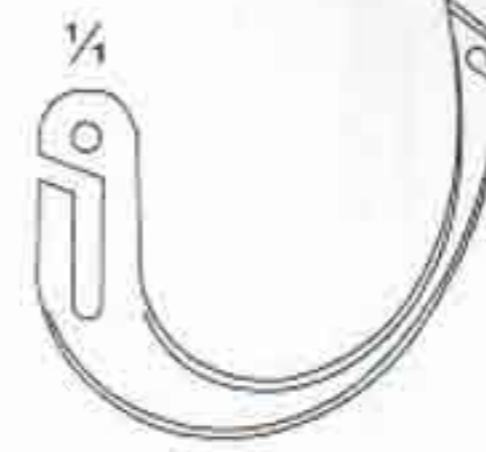

Fig. 4  
06-413 14.5cm



06-414



06-415

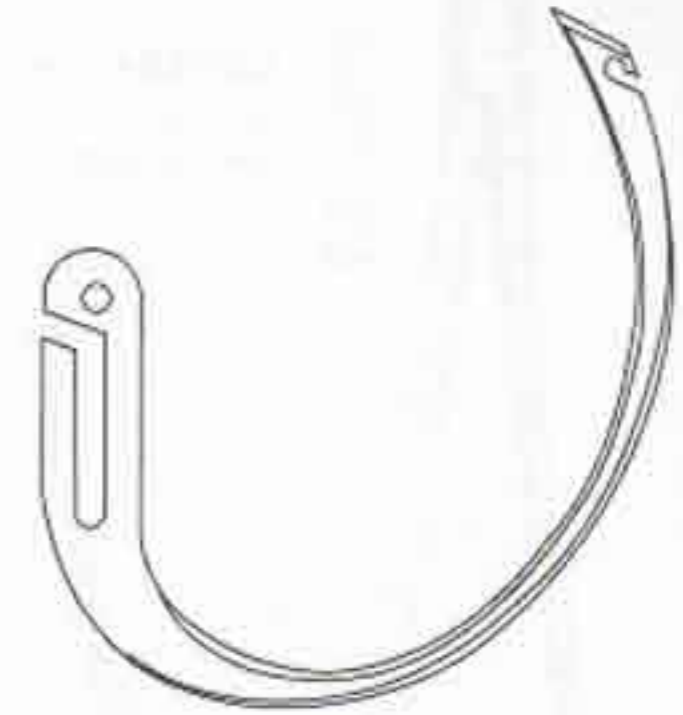

06-416



Fig. 1  
06-420



Fig. 2  
06-421



Fig. 3  
06-422



Fig. 4  
06-423







**06-440**  
12 cm  
Mini profile

**DERF**



**06-451**  
13 cm  
Mini profile

**06-452**  
14.5 cm  
Mini profile

**HEGAR-BAUMGARTNER**  
06-450



**06-461**  
13 cm  
Smooth jaw

**06-462**  
13 cm  
Mini profile

**HALSEY**  
06-460



**06-470**  
12 cm, 13 cm  
Two Sizes  
Smooth jaw

**WEBSTER**



**06-480**  
15 cm  
Mini profile

**CRILE-WOOD**



**06-490**  
13 cm  
Mini profile

**KILNER**



# NEEDLE HOLDERS T.C.

Nadelhalter  
Porta-agujas

Porte-agujas  
Portaghi



**WEBSTER**  
**06-501**  
13 cm  
Mini profile

06-500



**CRILE-WOOD**  
**06-502**  
15 cm

CRILE-WOOD



**06-510**  
20.5 cm  
Mini profile

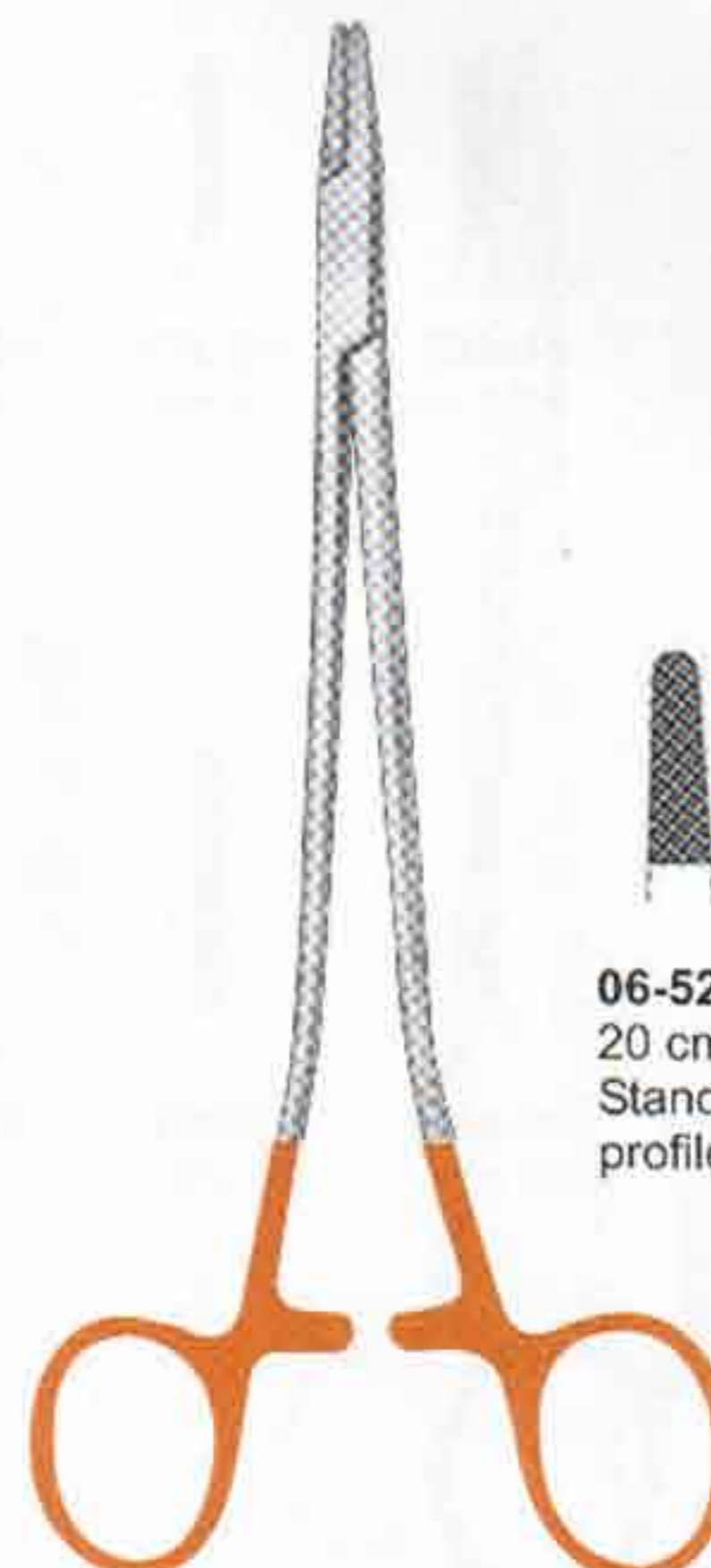

**SAROT**  
**06-520**



**06-521**  
18 cm  
Standard profile



**06-522**  
20 cm  
Standard profile



**06-523**  
26 cm  
Standard profile

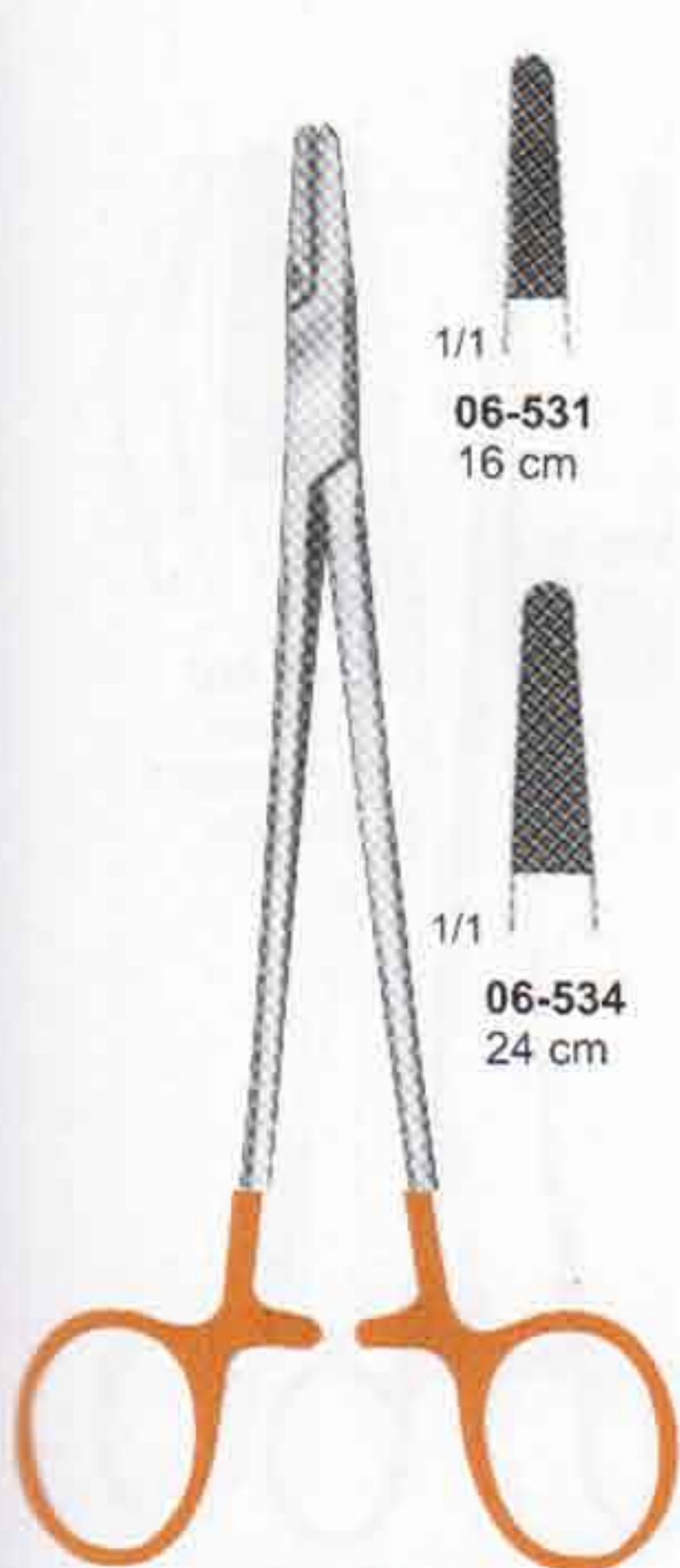

**MAYO-HEGAR**  
**06-530**  
Standard profile



**06-531**  
16 cm



**06-532**  
18 cm



**06-533**  
20 cm



**06-534**  
24 cm



**06-535**  
26 cm



**06-536**  
30 cm

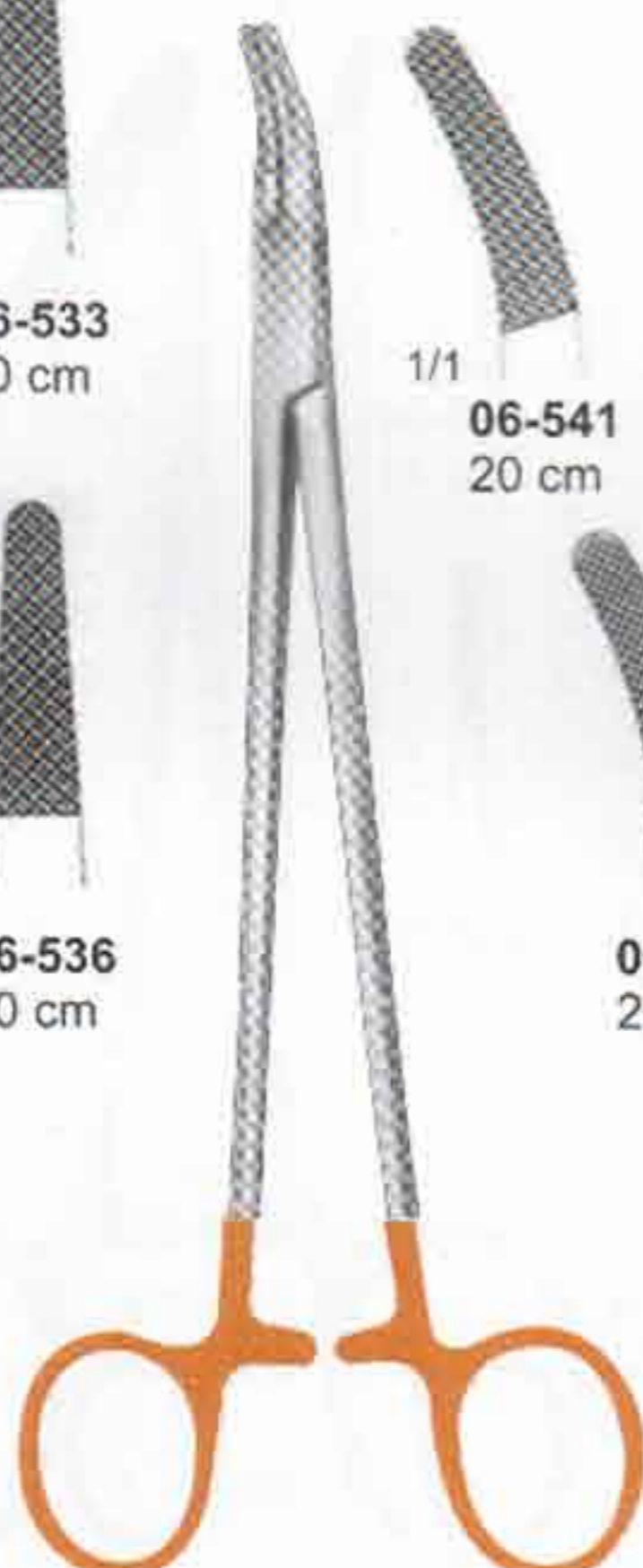

**HEANEY**  
**06-540**  
Standard profile



**06-541**  
20 cm



**06-542**  
24 cm



**06-543**  
26 cm

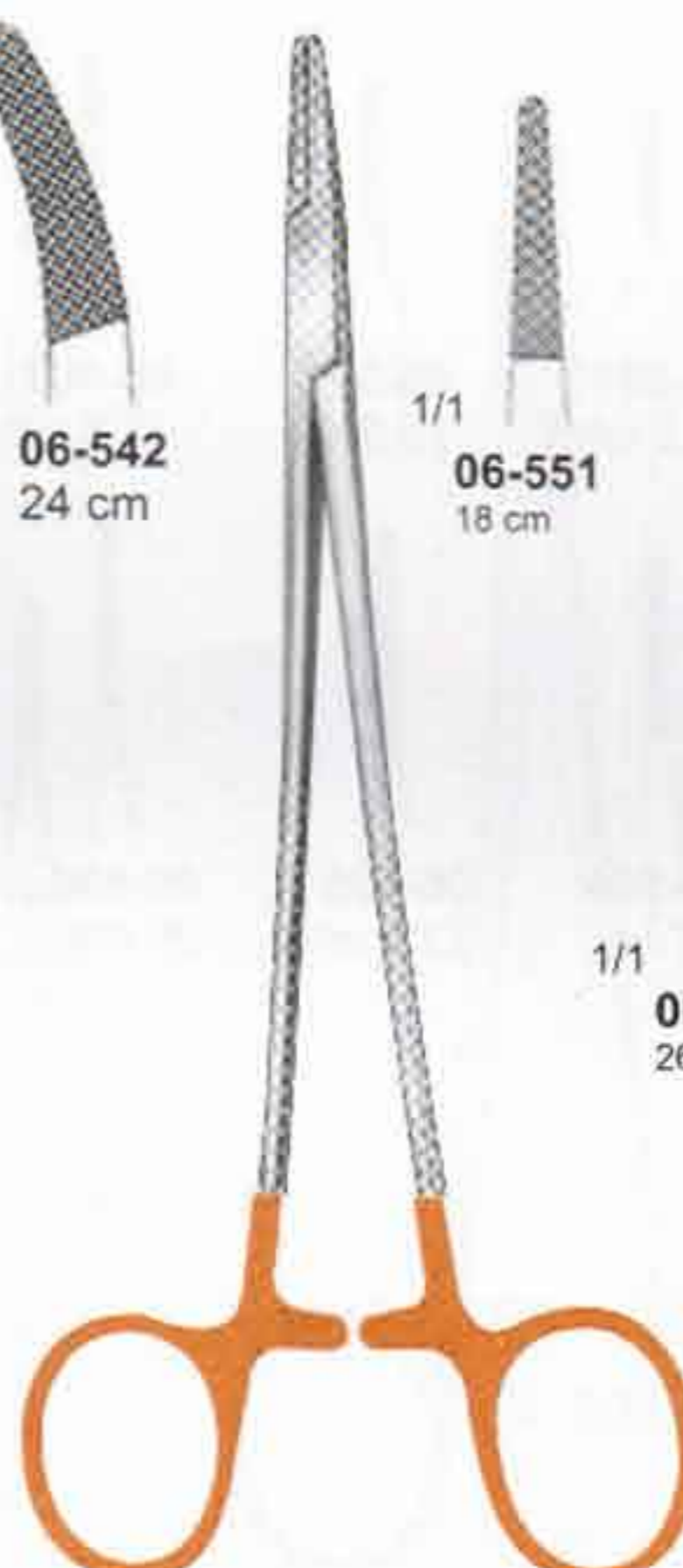

**DeBAKEY**  
**06-550**  
Delicate pattern  
mini profile



**06-551**  
18 cm



**06-552**  
20 cm



**06-553**  
23 cm



**06-554**  
26 cm



**06-555**  
31 cm



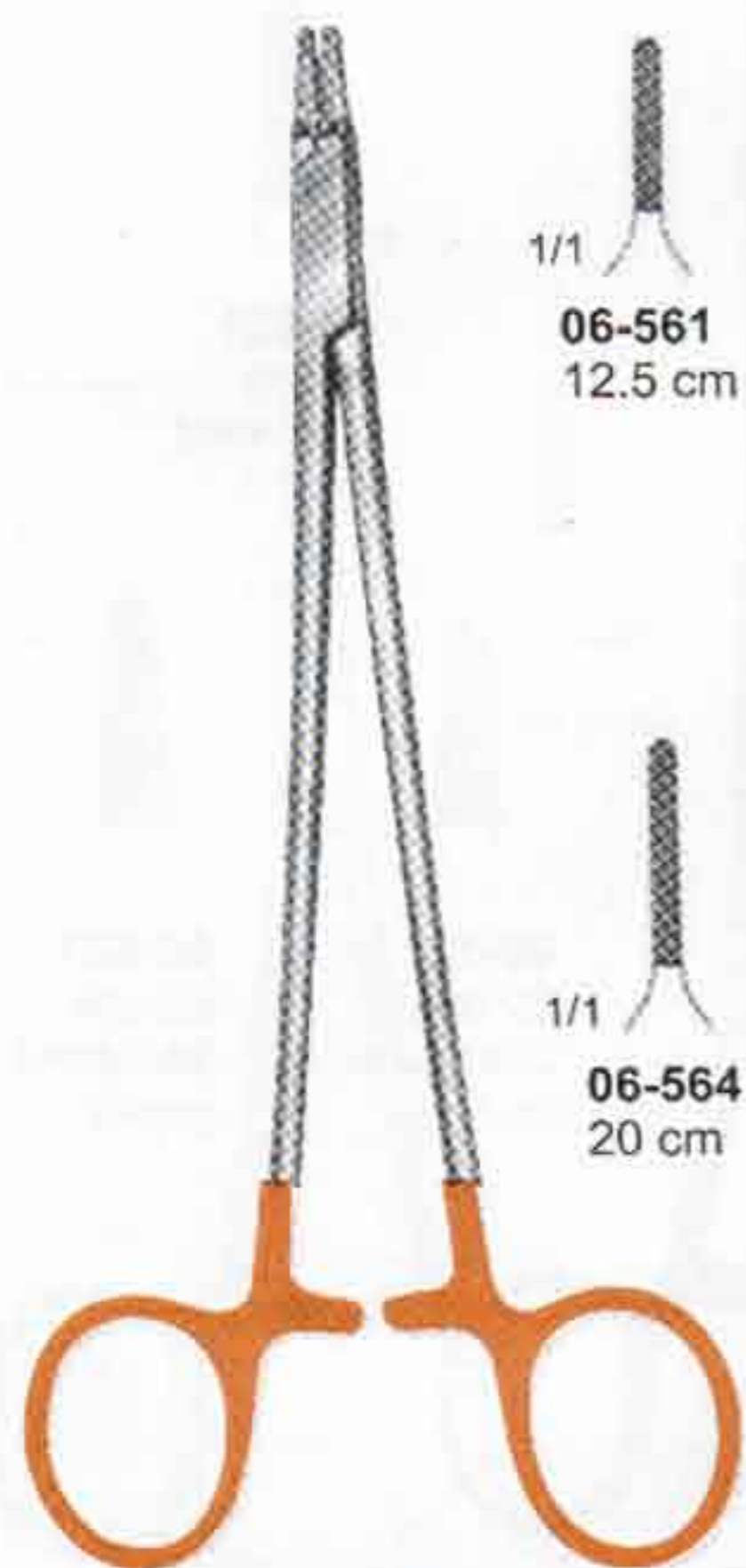

**RAYDER**  
**06-560**  
Mini profile

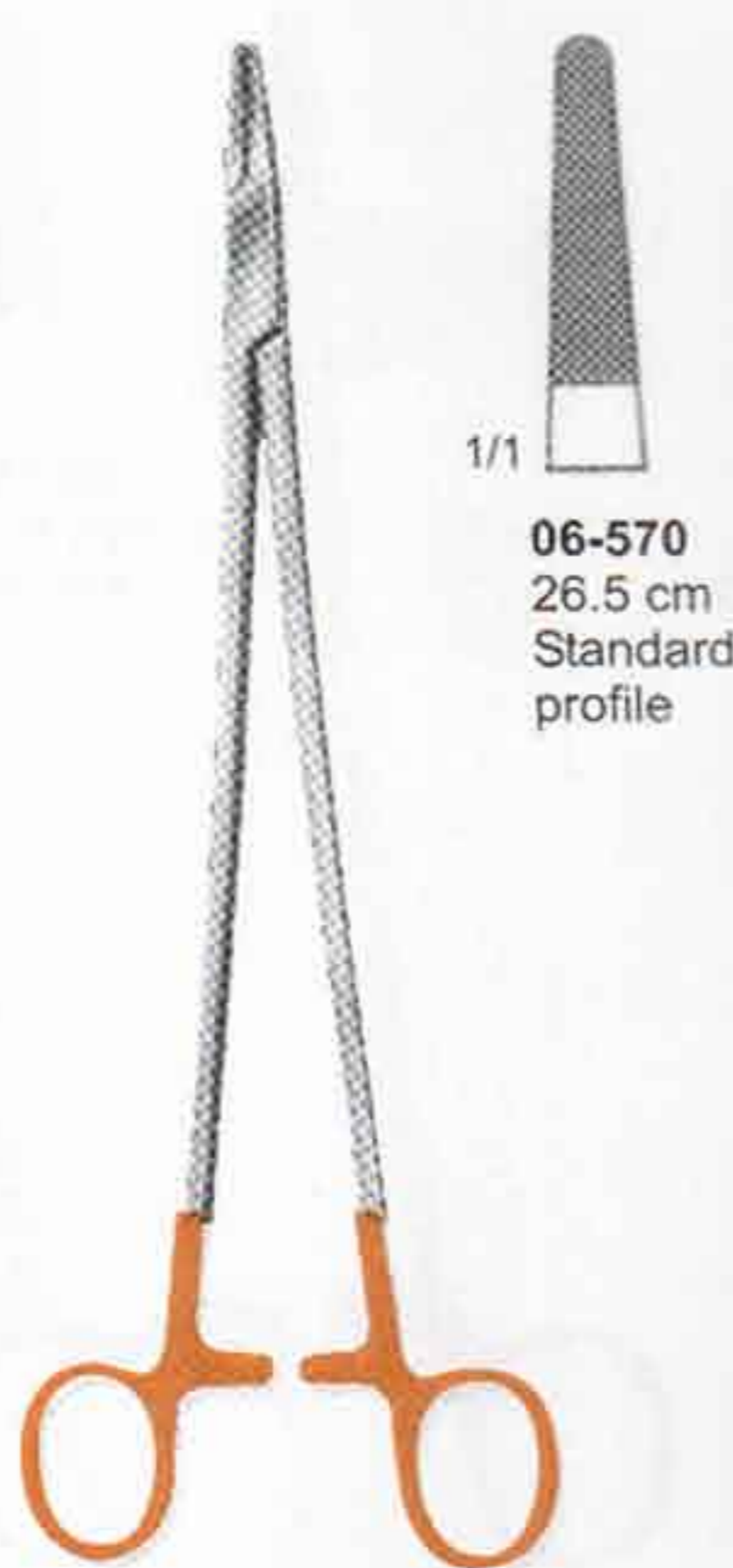
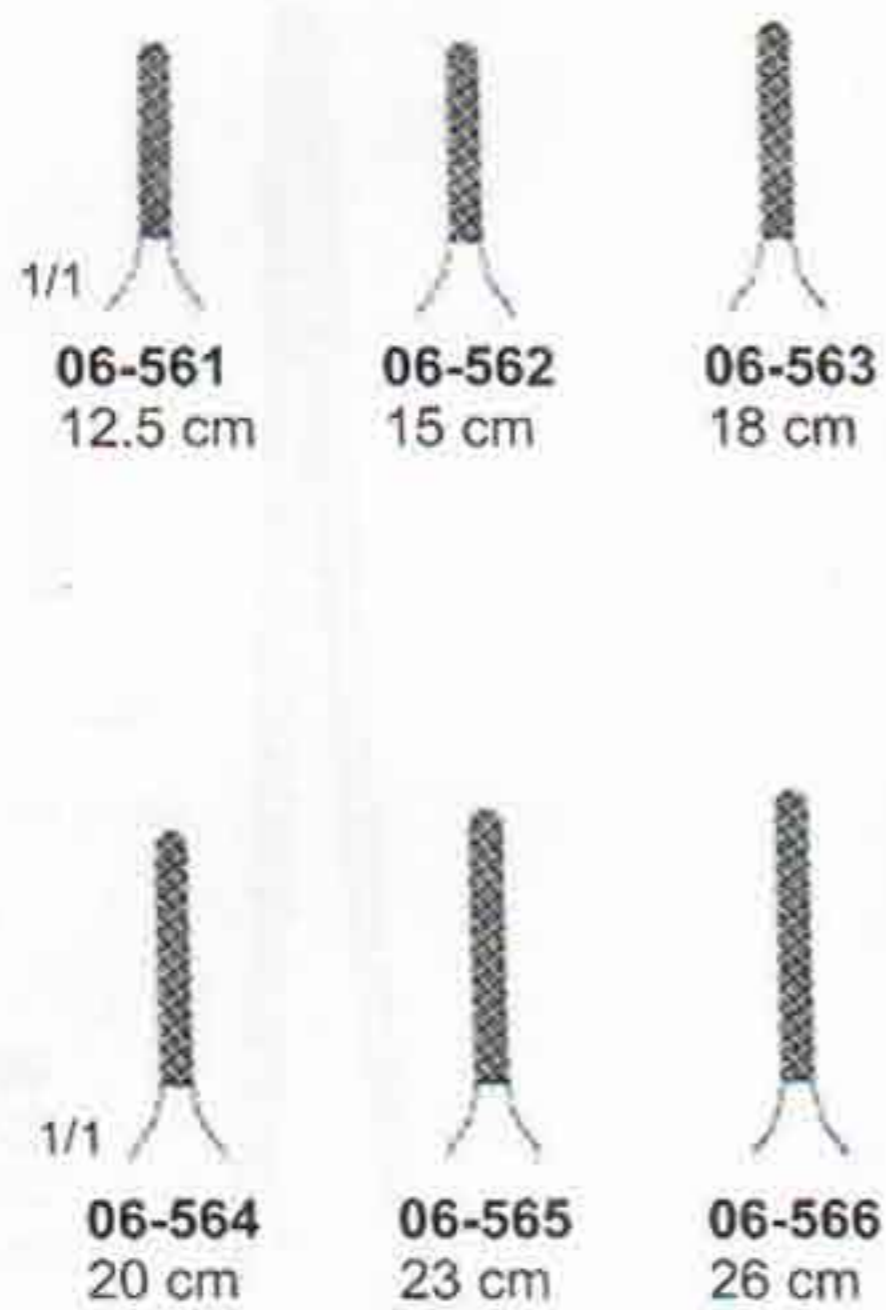

**MASSON**



**06-580**  
mini profile  
elastic type

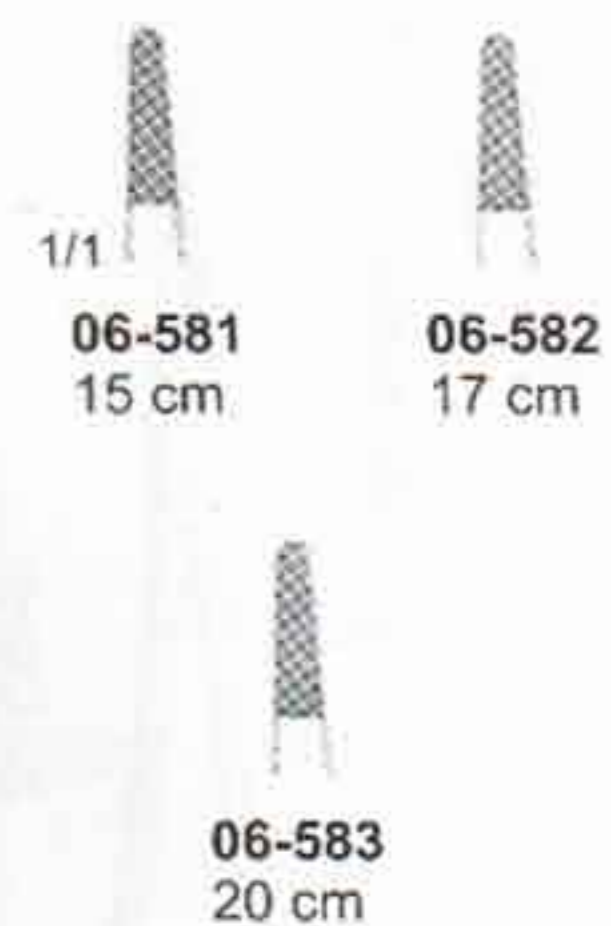

**RYDER-VASCULAR**  
**06-590**  
Slender pattern  
micro profile

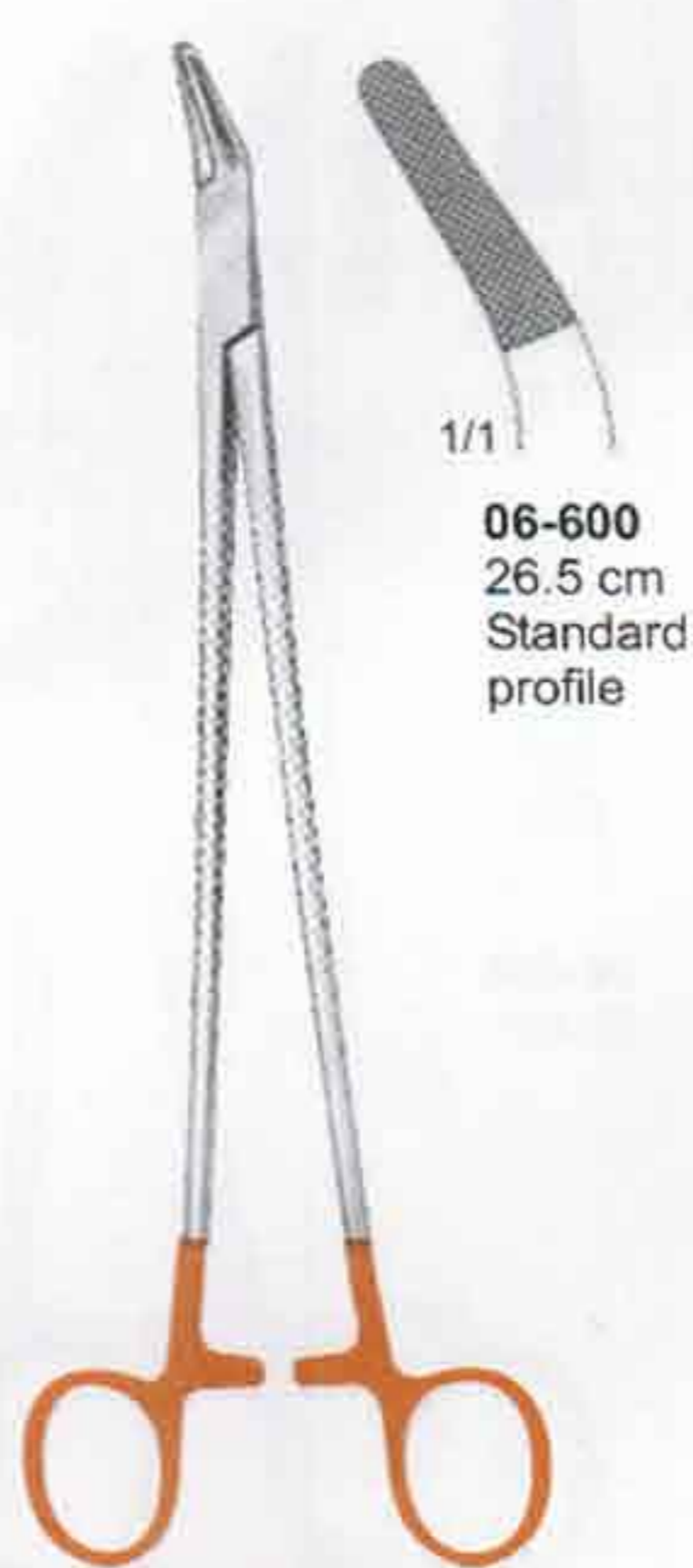
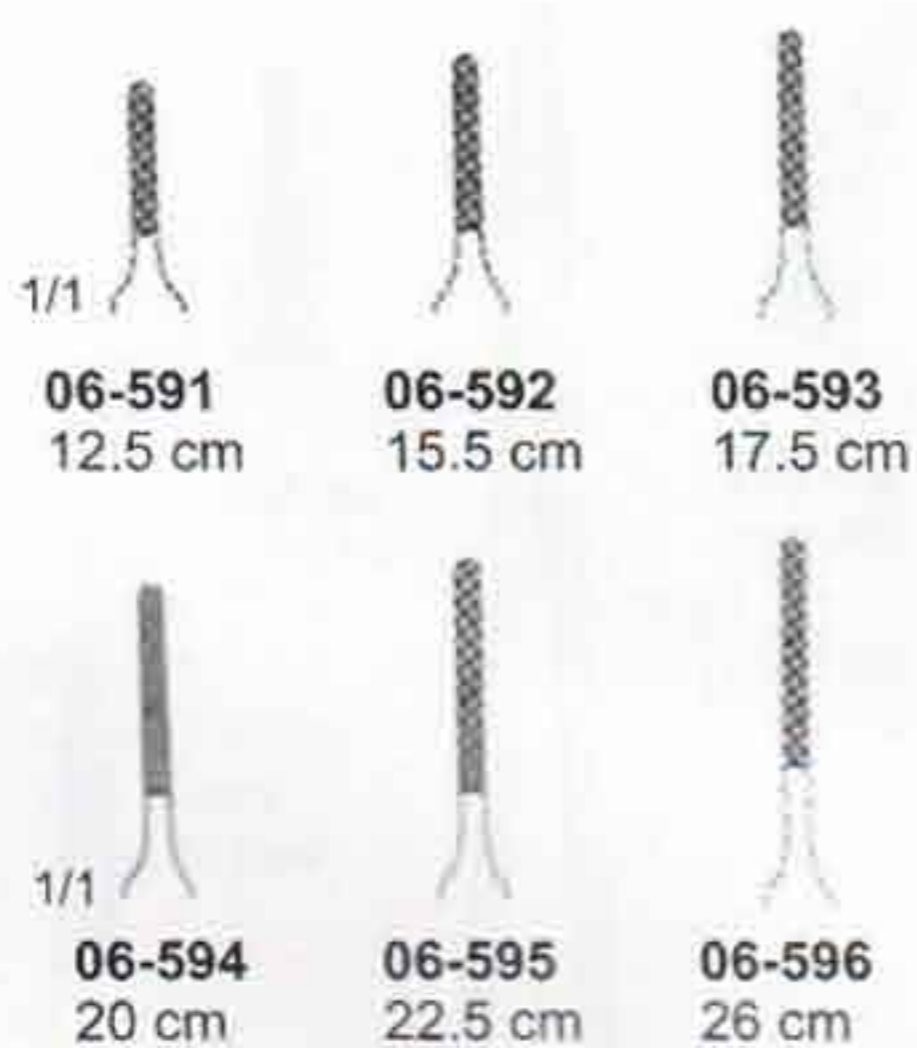

**FINOCHIETTO**

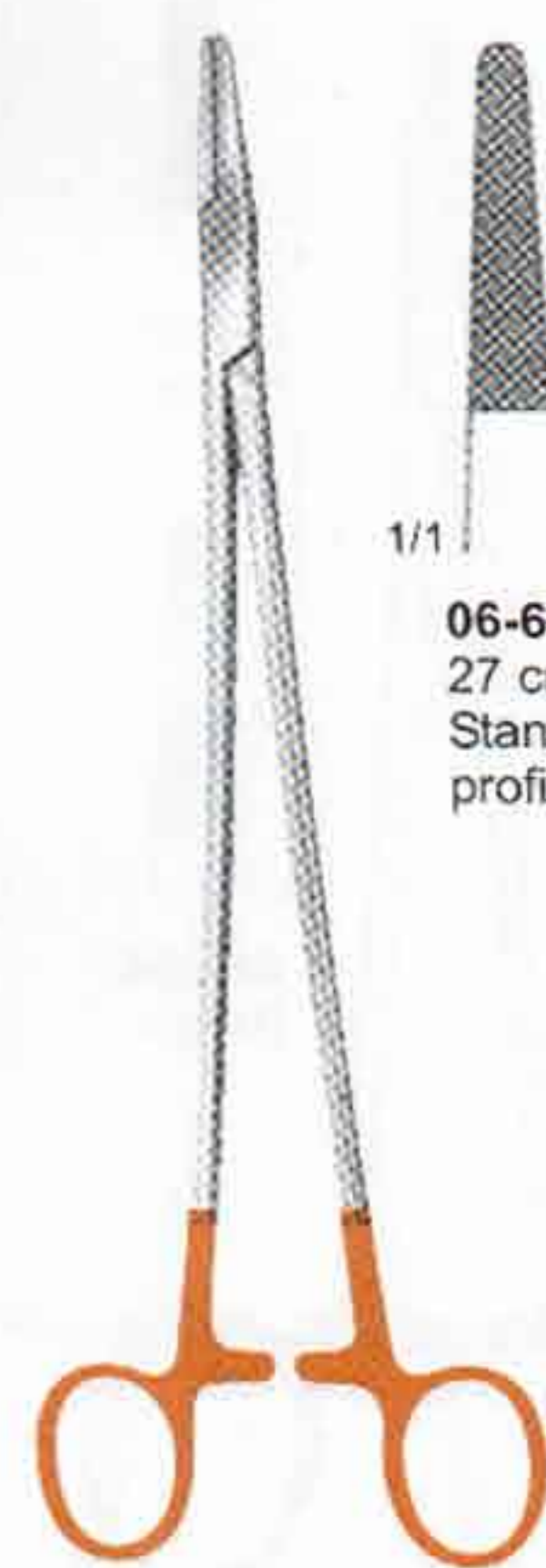
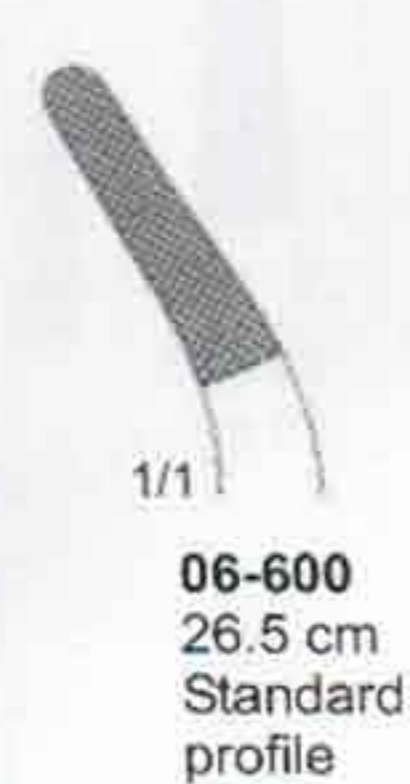

**WANGENSTEEN**





# NEEDLE HOLDERS T.C.

Nadelhalter  
Porta-agujas

Porte-agujas  
Portaghi

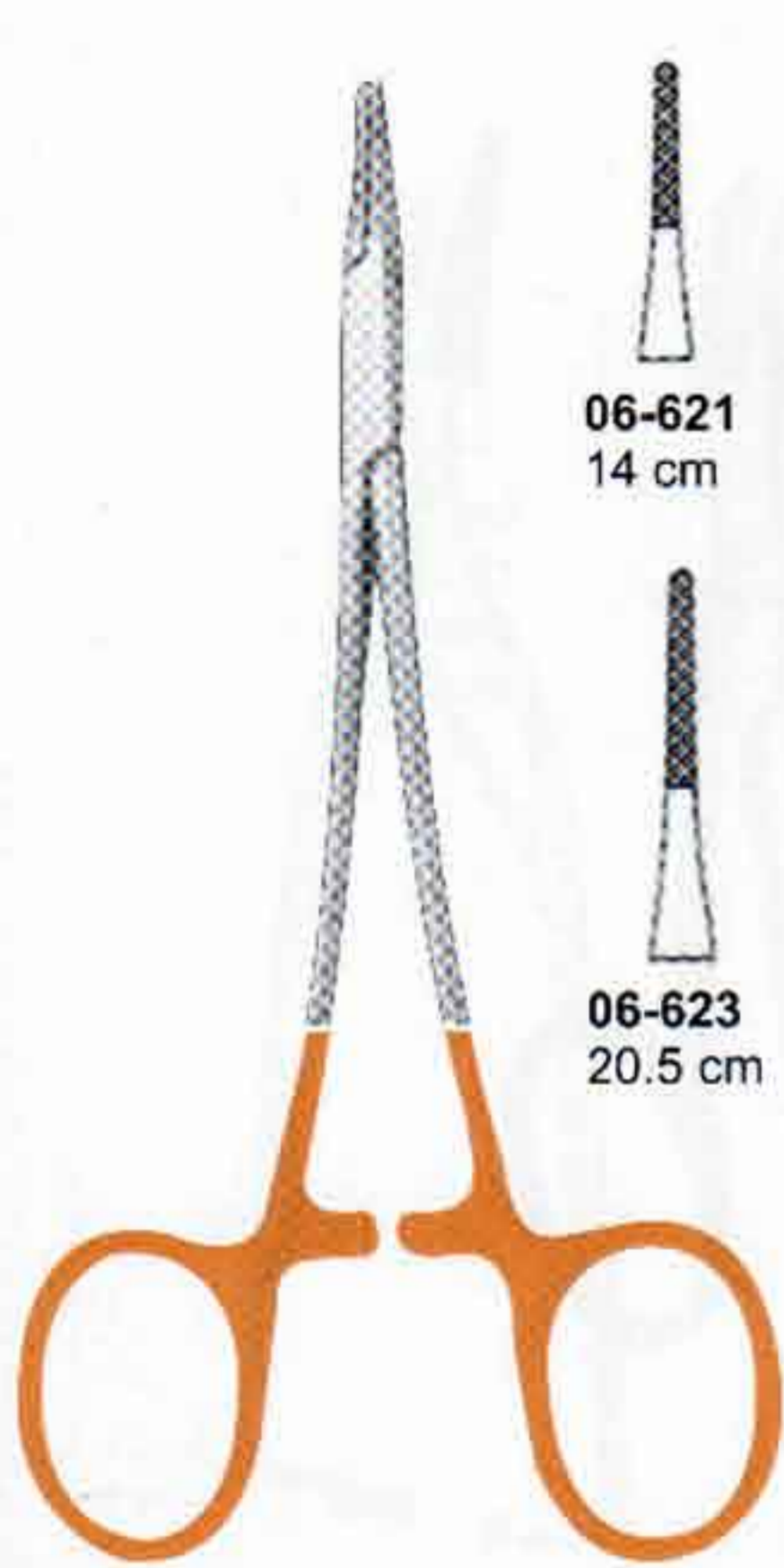

**HEGAR-VASCULAR**  
**06-620**  
Micro profile

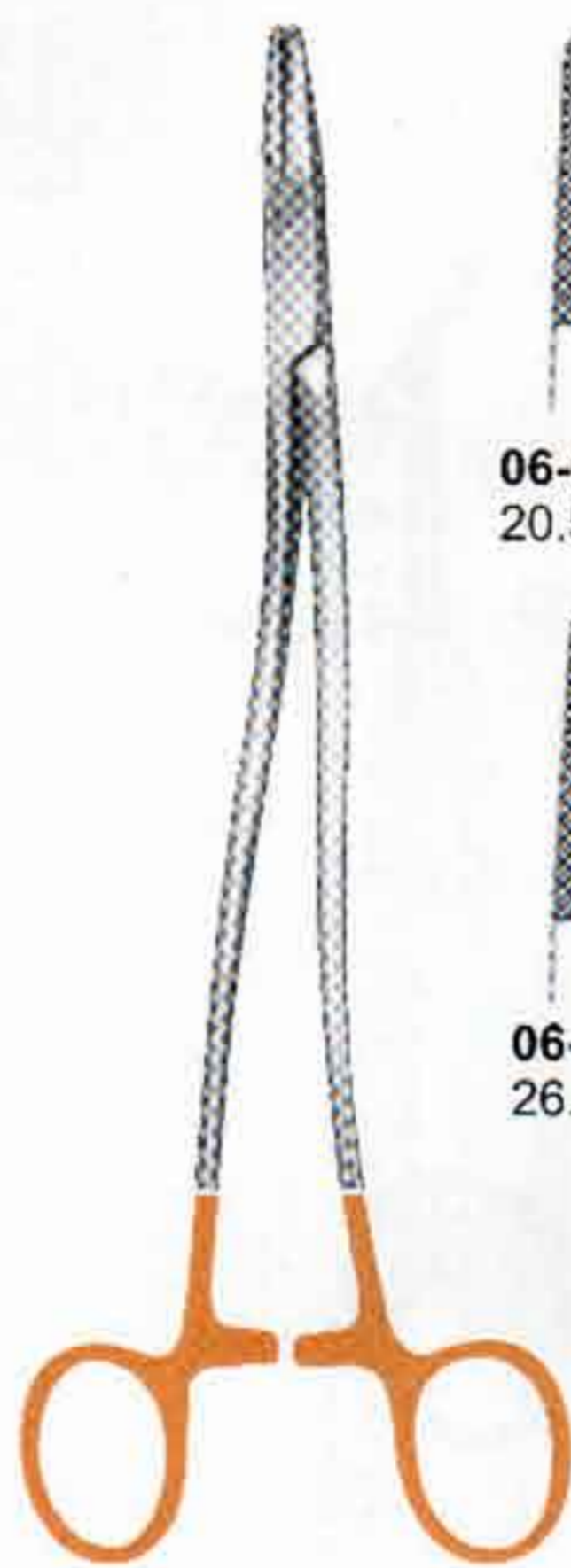

**BOZEMANN**  
**06-630**  
Standard profile



**HEGAR**  
**06-640**  
Standard profile

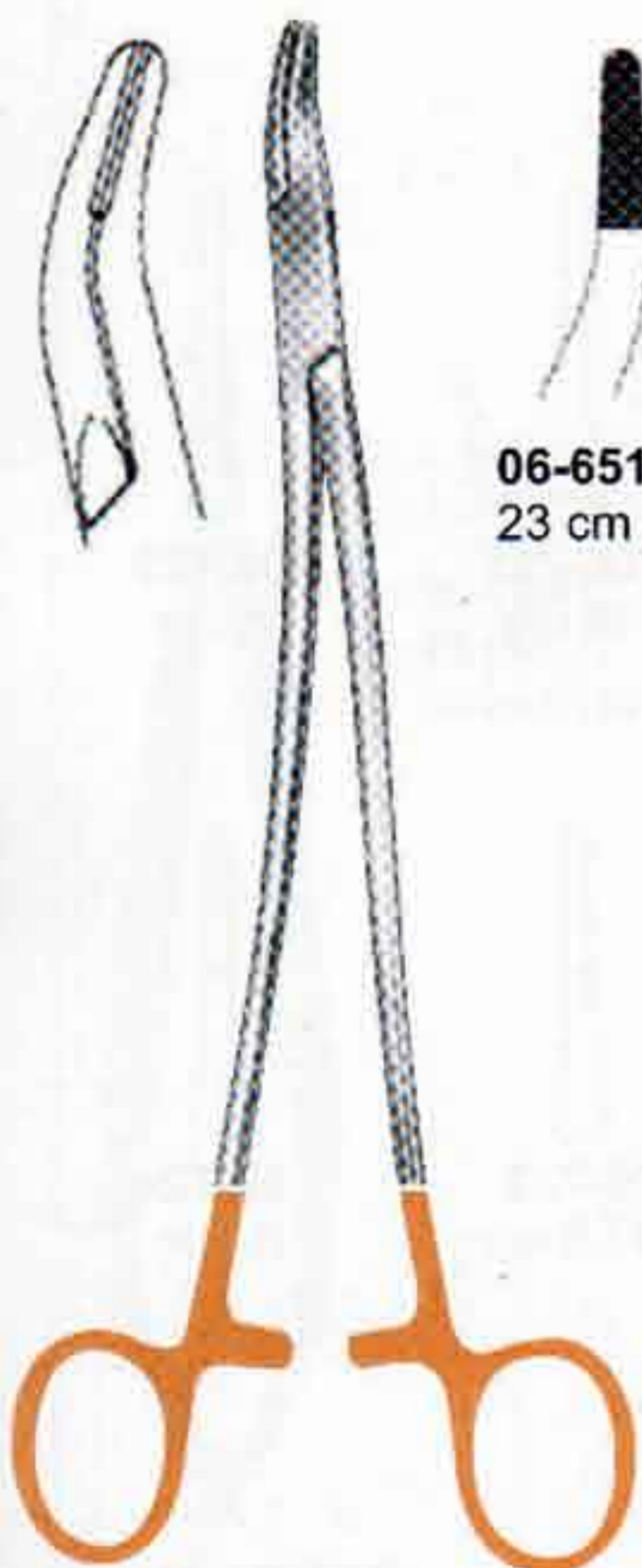

**STRATTE**  
**06-650**  
Standard profile



**MARTINI**  
**06-660**  
Slender pattern,  
micro profile



**OLSEN-HEGAR**  
**06-670**  
Standard profile





# NEEDLE HOLDERS T.C.

Nadelhalter  
Porta-agujas

Porte-agujas  
Portaghi



**06-680**  
11 cm  
Smooth jaw

**FOSTER-GILLIES**



**06-690**  
15 cm  
Mini profile

**GILLIES-MINI**



**06-700**  
16 cm  
Standard profile

**GILLIES**



**MICROVASCULAR**  
**06-710**  
Slender pattern,  
micro profile



**06-711**  
14 cm



**06-712**  
17.5 cm



**06-713**  
20 cm



**06-714**  
23 cm



**MARTINI**  
**06-720**  
Slender pattern,  
smooth jaw



**06-721**  
14 cm



**06-722**  
16 cm



**06-723**  
17.5 cm



**06-724**  
20 cm



# NEEDLE HOLDERS T.C.

Nadelhalter  
Porta-agujas

Porte-agujas  
Portaghi



**ARRUGA**  
06-730



**06-731**  
16 cm  
Mini profile



**06-732**  
16 cm



**CASTROVIEJO**



**06-740**  
12.5 cm  
With lock,  
smooth jaw



**BARRAQUER**



**06-750**  
13 cm  
With lock,  
smooth jaw



**BARRAQUER**



**06-760**  
13 cm  
Smooth jaw



**CASTROVIEJO**  
06-770



**06-771**  
With lock  
14.5 cm



**06-772**  
With lock  
14.5 cm



**06-773**  
14.5 cm  
Smooth jaw



**06-774**  
18 cm  
With lock



**06-775**  
21.5 cm  
With lock



**06-776**  
14.5 cm  
Smooth



**06-777**  
18 cm  
With lock



**06-778**  
With lock  
21.5 cm



# NEEDLE HOLDERS T.C.

Nadelhalter  
Porta-agujas

Porte-agujas  
Portaghi



**06-780**  
Standard profile



**ZWEIFEL**  
**06-790**  
Standard profile

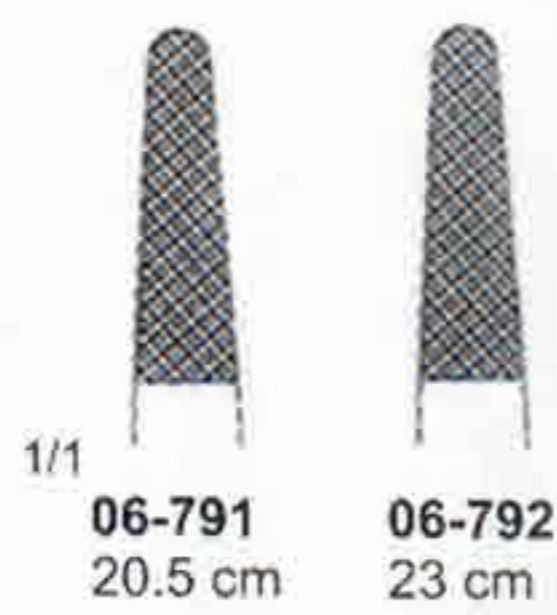

**TOENNIS**

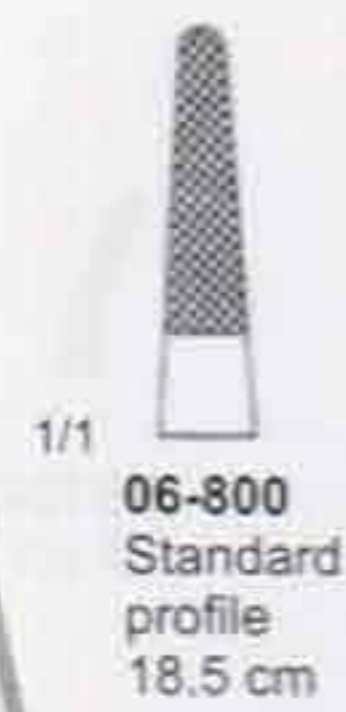

**LICHTENBERG**



**MATHIEU**  
**06-820**  
Standard profile

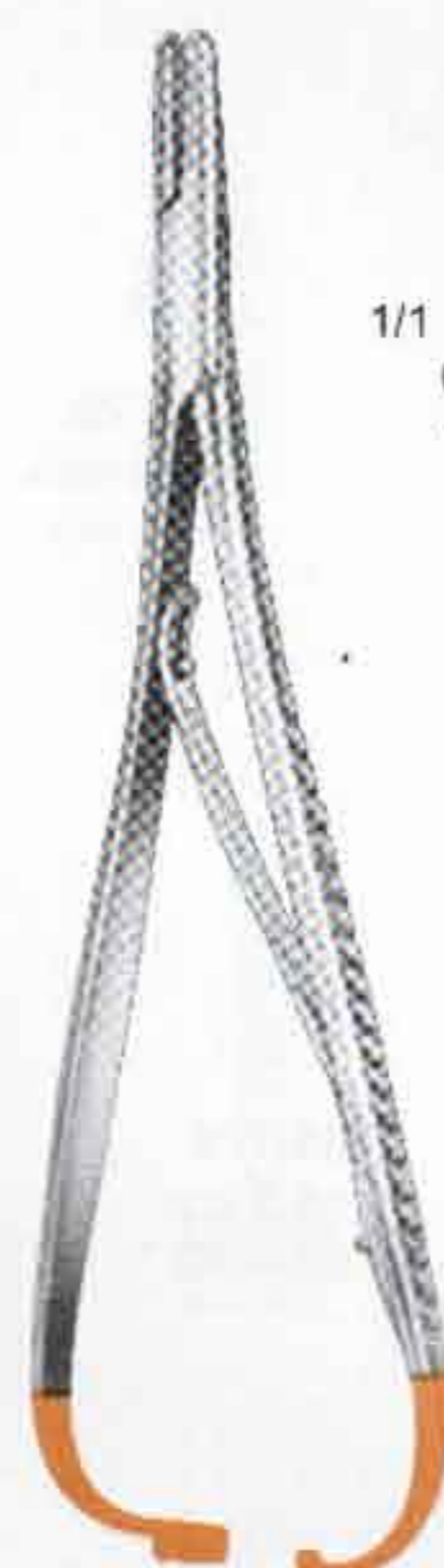
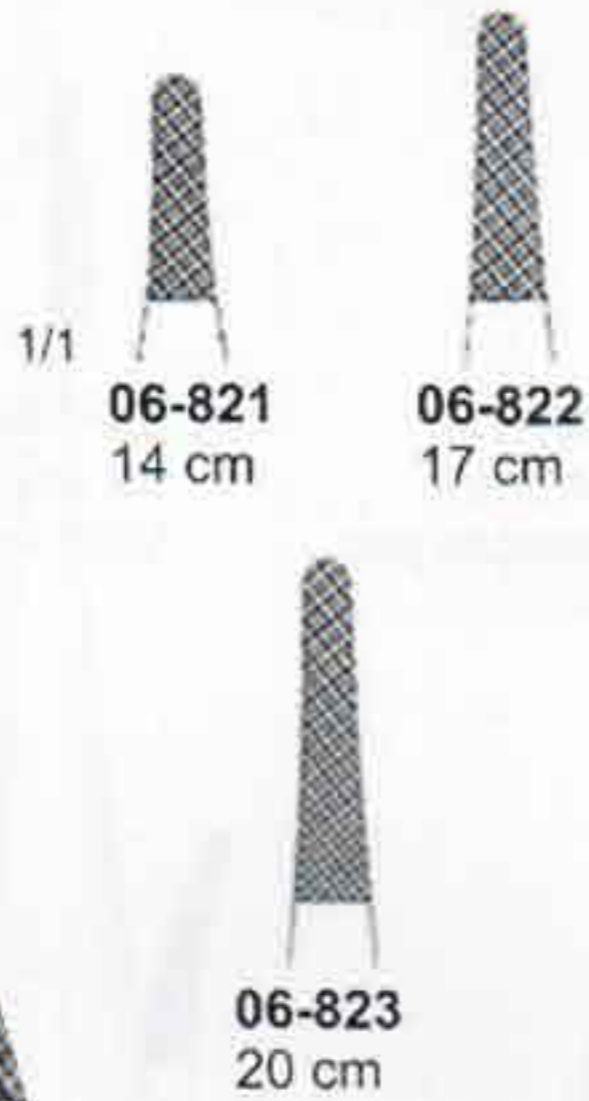

**MATHIEU**  
**06-830**  
Standard profile

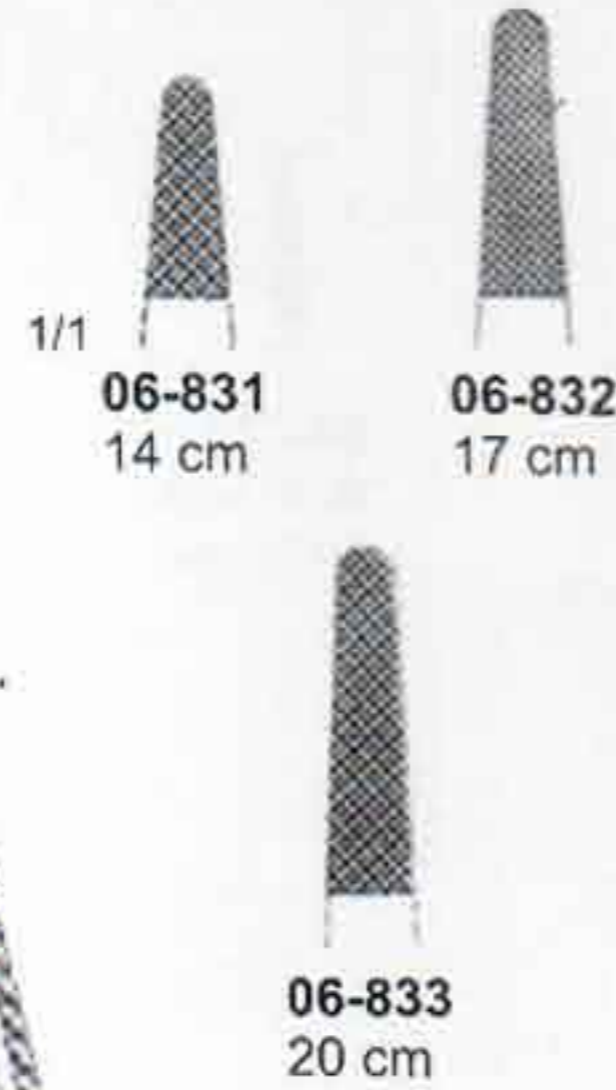

**MATHIEU**  
**06-840**  
Standard profile

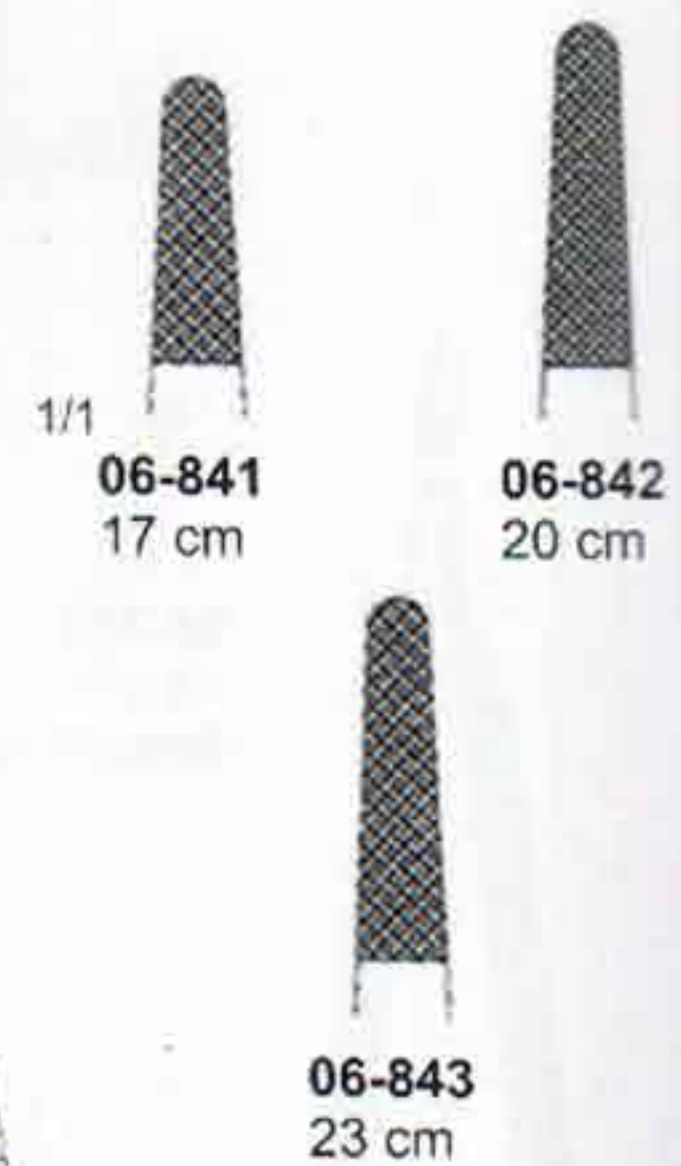



# NEEDLE HOLDERS T.C.

Nadelhalter  
Porta-agujas

Porte-agujas  
Portaghi





# GENERAL INSTRUMENTS

Allgemeines Instrumentarium  
Instrumental general

Instrumentation générale  
Strumentario generale



**MICHEL**  
06-920 12cm



**MICHEL**  
06-930 12cm



**WACHENFELDT**  
06-940 12.5cm



**WACHENFELDT**  
06-950 12.5cm



**HEGENBARTH**  
06-960 12.5cm



**CHILDE**  
06-970 18cm



**CHILDE**  
06-980 18cm

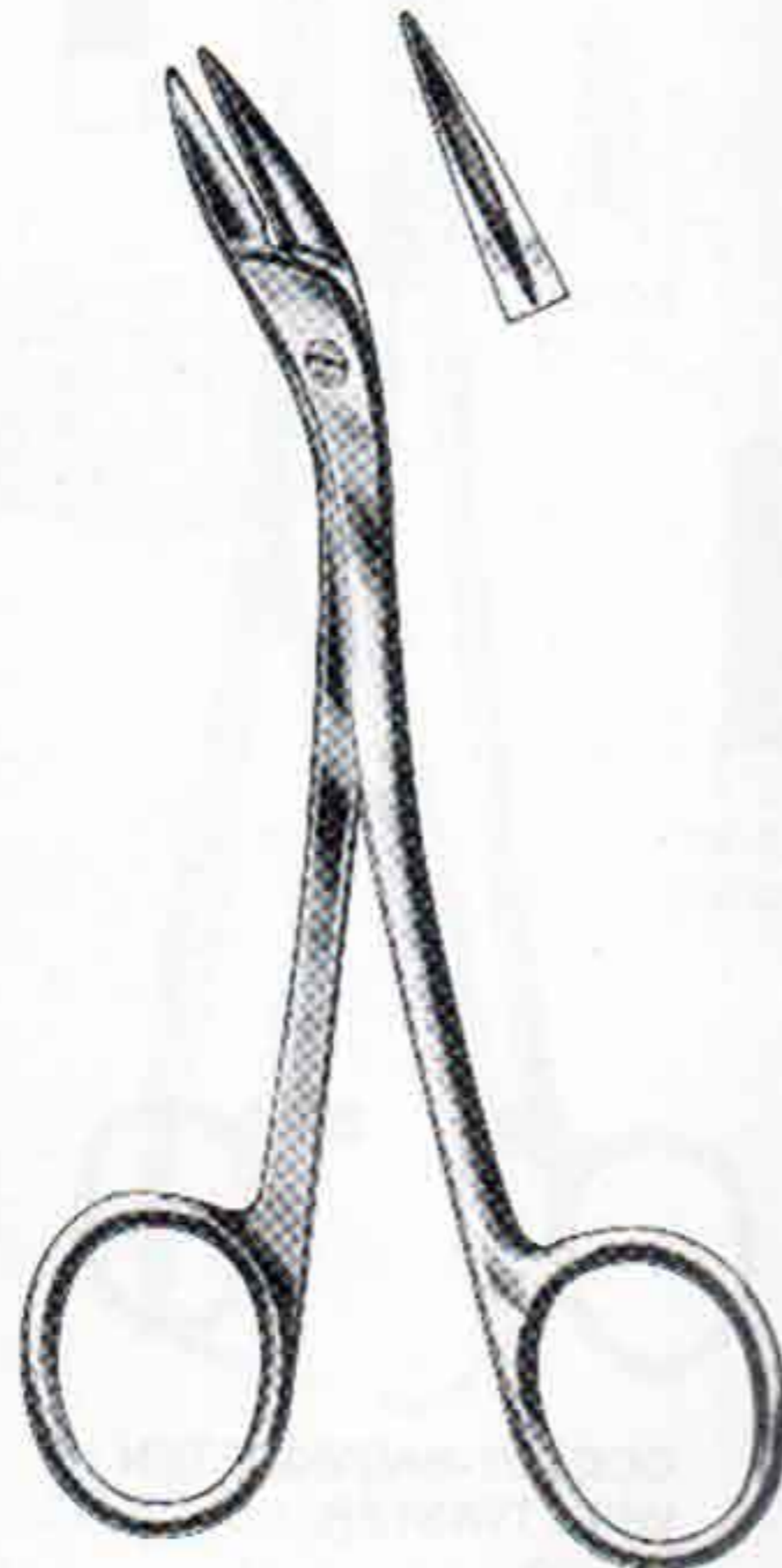

**RICHTER-HEATH**  
06-990 14cm

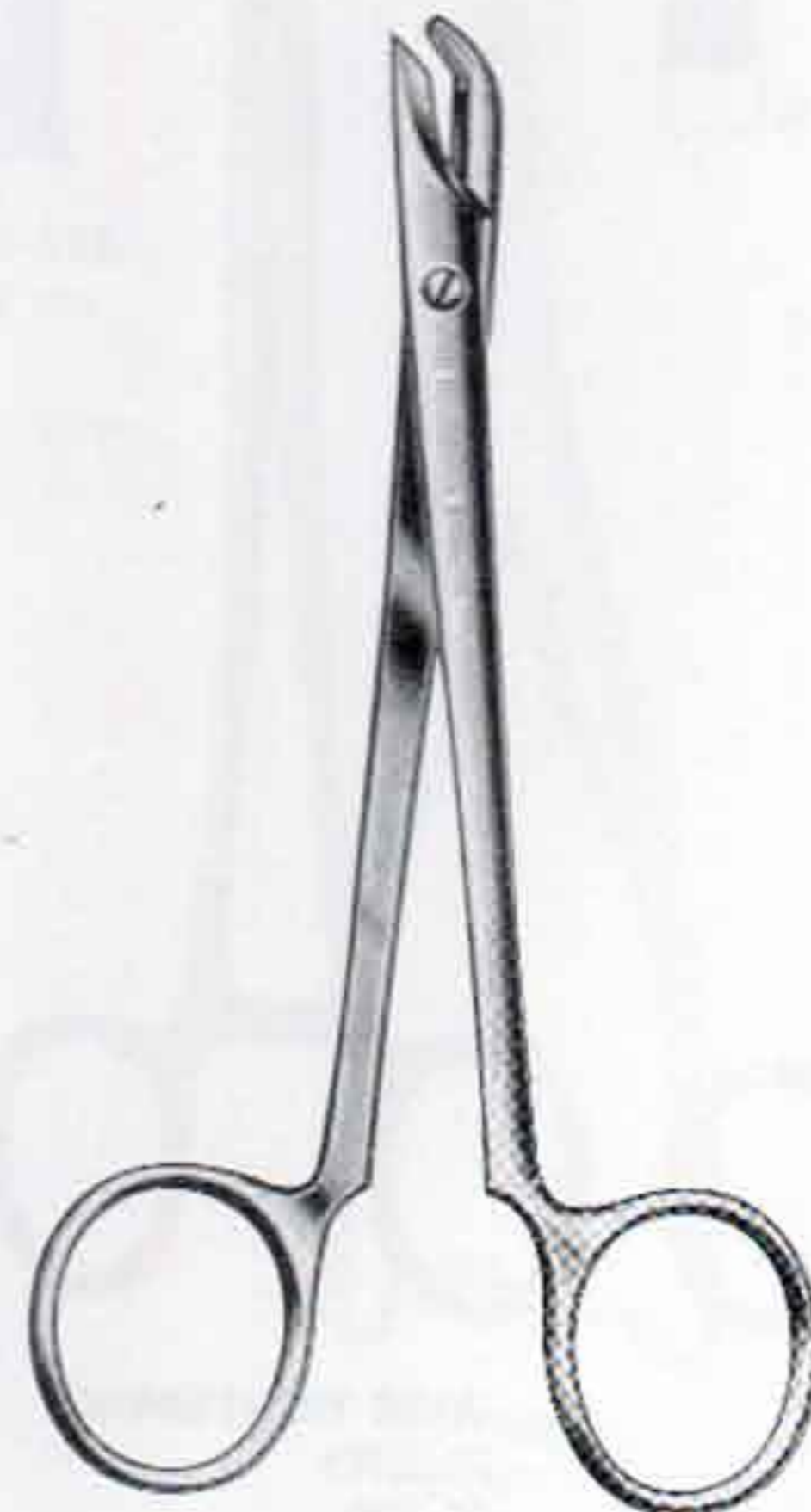

**COLLIN**  
06-1000 13cm



**MICHEL**  
06-1010 12cm



# GENERAL INSTRUMENTS

Allgemeines Instrumentarium  
Instrumental general

Instrumentation générale  
Strumentario generale



## PROBES

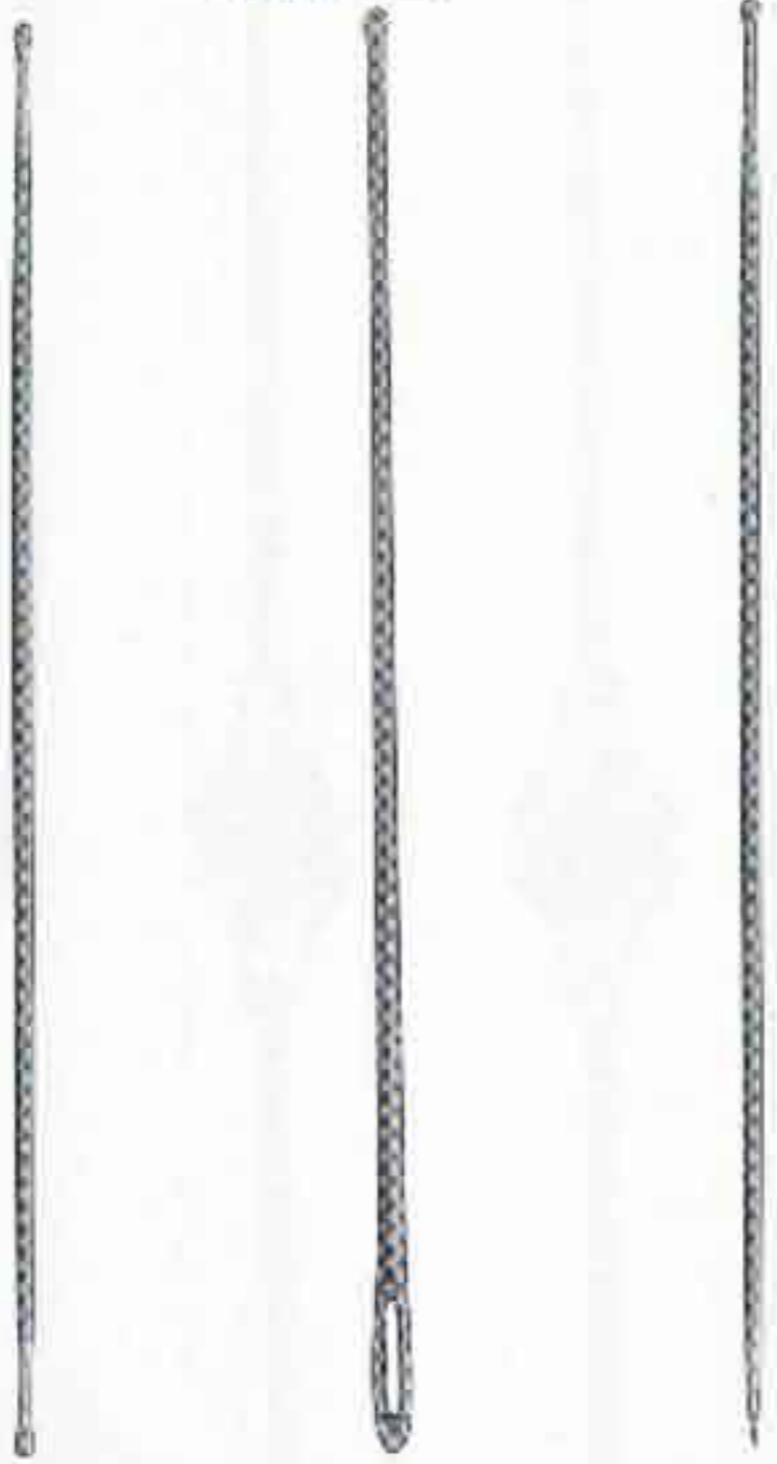

- |                |         |                |
|----------------|---------|----------------|
| 06-1020 11.5cm | 06-1030 | 06-1040 12.5cm |
| 06-1021 12.5cm | 06-1031 | 06-1041 14 cm  |
| 06-1022 14 cm  | 06-1032 | 06-1042 16 cm  |
| 06-1023 16 cm  | 06-1033 |                |
| 06-1024 18 cm  | 06-1034 |                |
| 06-1025 20 cm  | 06-1035 |                |
| 06-1026 25 cm  | 06-1036 |                |

## DIRECTOR

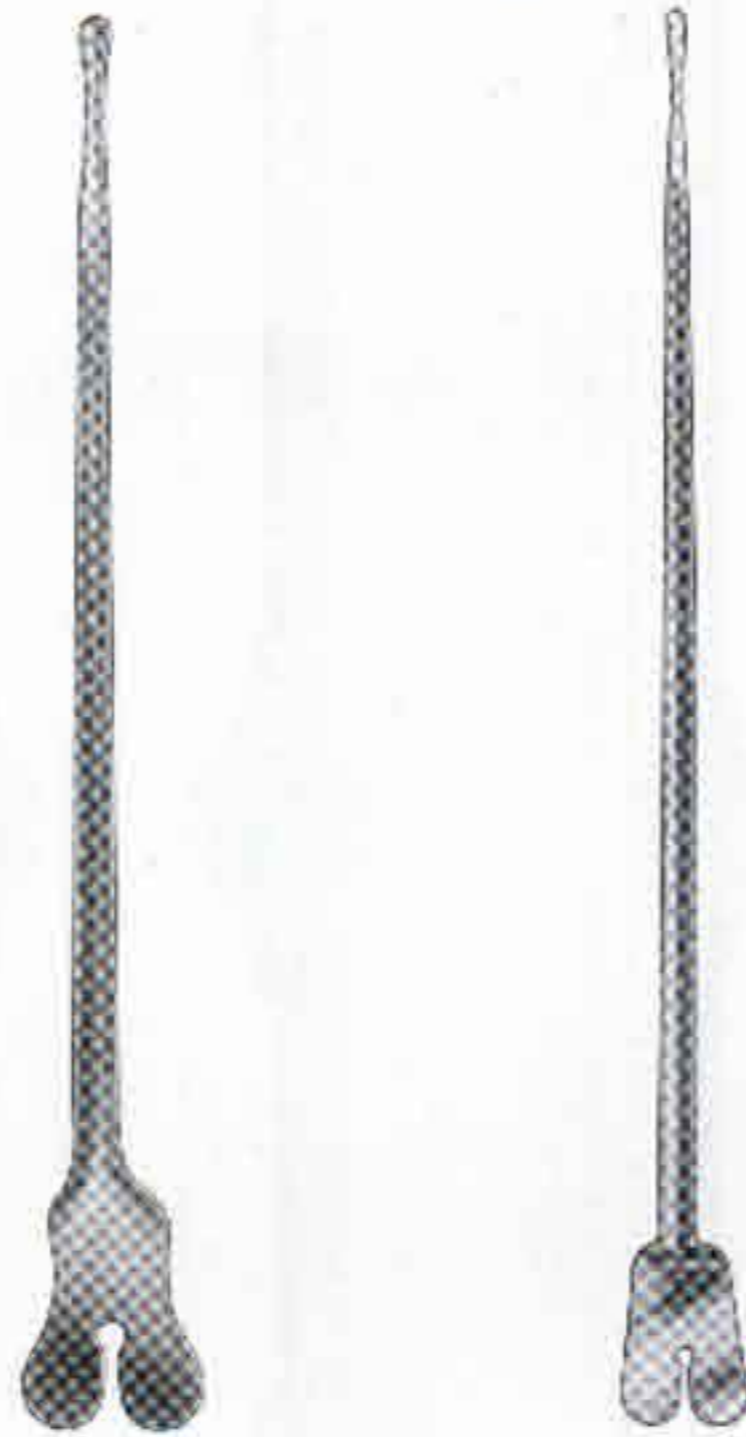

- |                |         |
|----------------|---------|
| 06-1050 12.5cm | 06-1060 |
| 06-1051 14 cm  | 06-1061 |
| 06-1052 16 cm  | 06-1062 |



- MAYO**  
06-1070 14cm

## SPATULA



- PLASTER**  
06-1080 13cm  
06-1081 16cm



- 06-1090 13cm

## NEEDLES

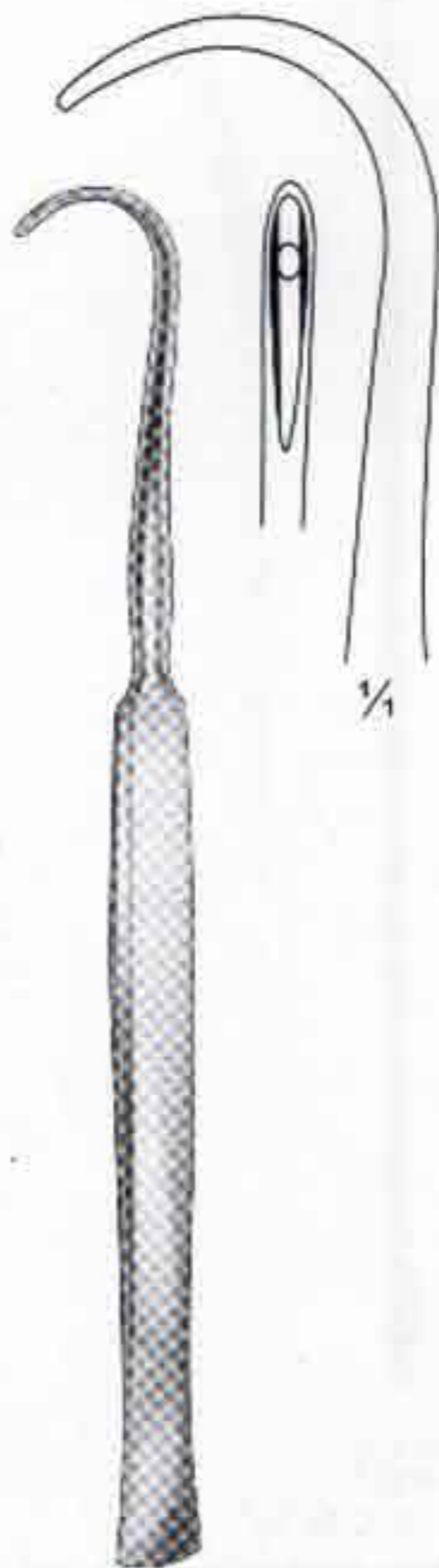

- SYME**  
06-1100

## DISSECTORS



- McDONALD**  
06-1110 19cm



- CHEYNE**  
06-1120 12.5cm  
06-1121 17.5cm

## APPLICATORS



- FARRELL**  
06-1130 12cm 06-1140  
06-1131 14cm 06-1141  
06-1132 16cm 06-1142  
06-1133 18cm 06-1143



- JOBSON-HORNE**  
06-1150 12.5cm  
06-1151 18 cm



## BOWMAN LACRIMAL PROBES

Double Ended, Sterling Silver

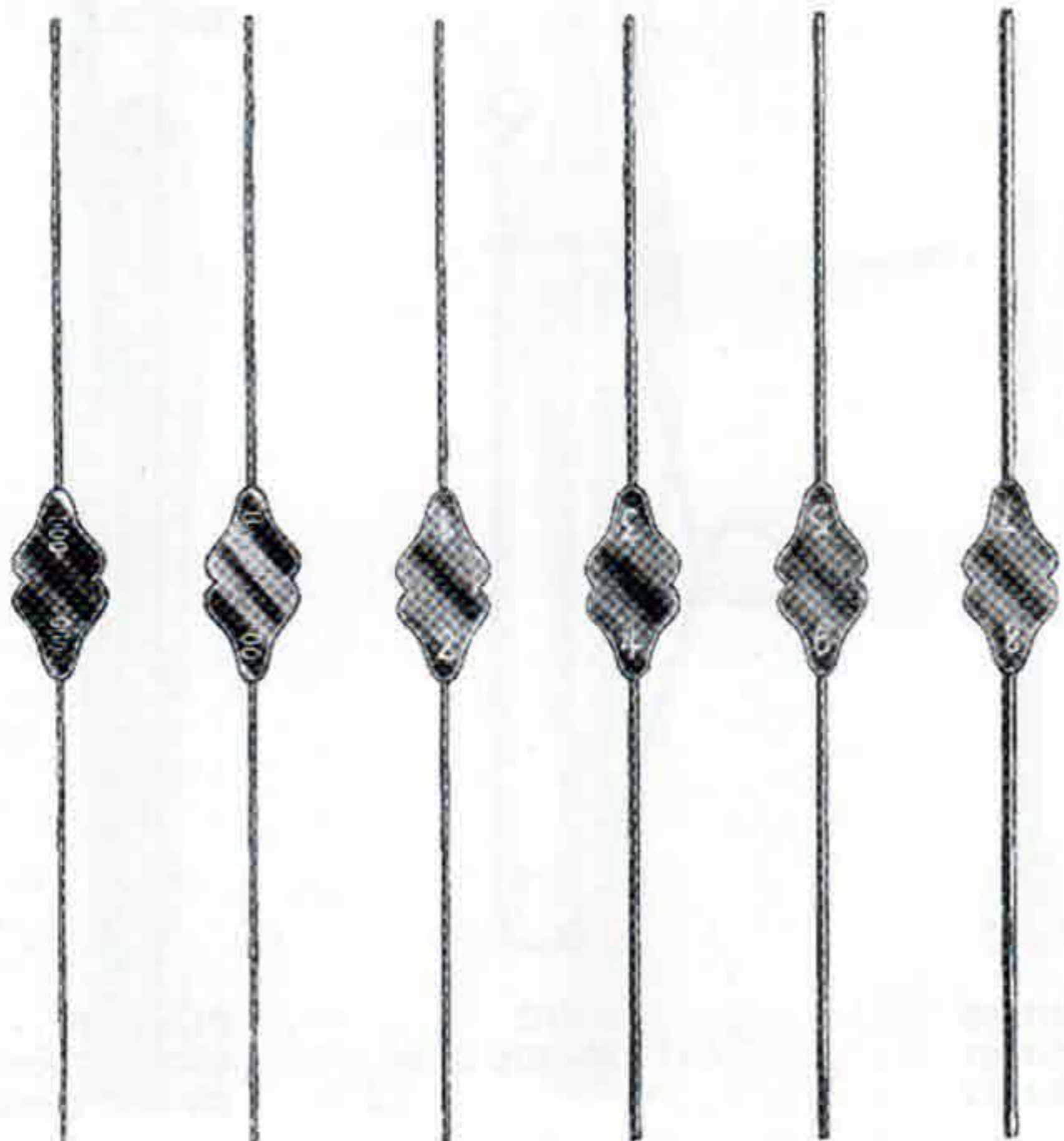

<b>06-1160</b> Bowman Probe, 000-0000	<b>06-1161</b> Bowman Probe, 00-0	<b>06-1162</b> Bowman Probe, 1-2	<b>06-1163</b> Bowman Probe, 3-4	<b>06-1164</b> Bowman Probe, 5-6	<b>06-1165</b> Bowman Probe, 7-8
--	--	---	---	---	---

## WILLIAM LACRIMAL PROBES

Double Ended, Sterling Silver

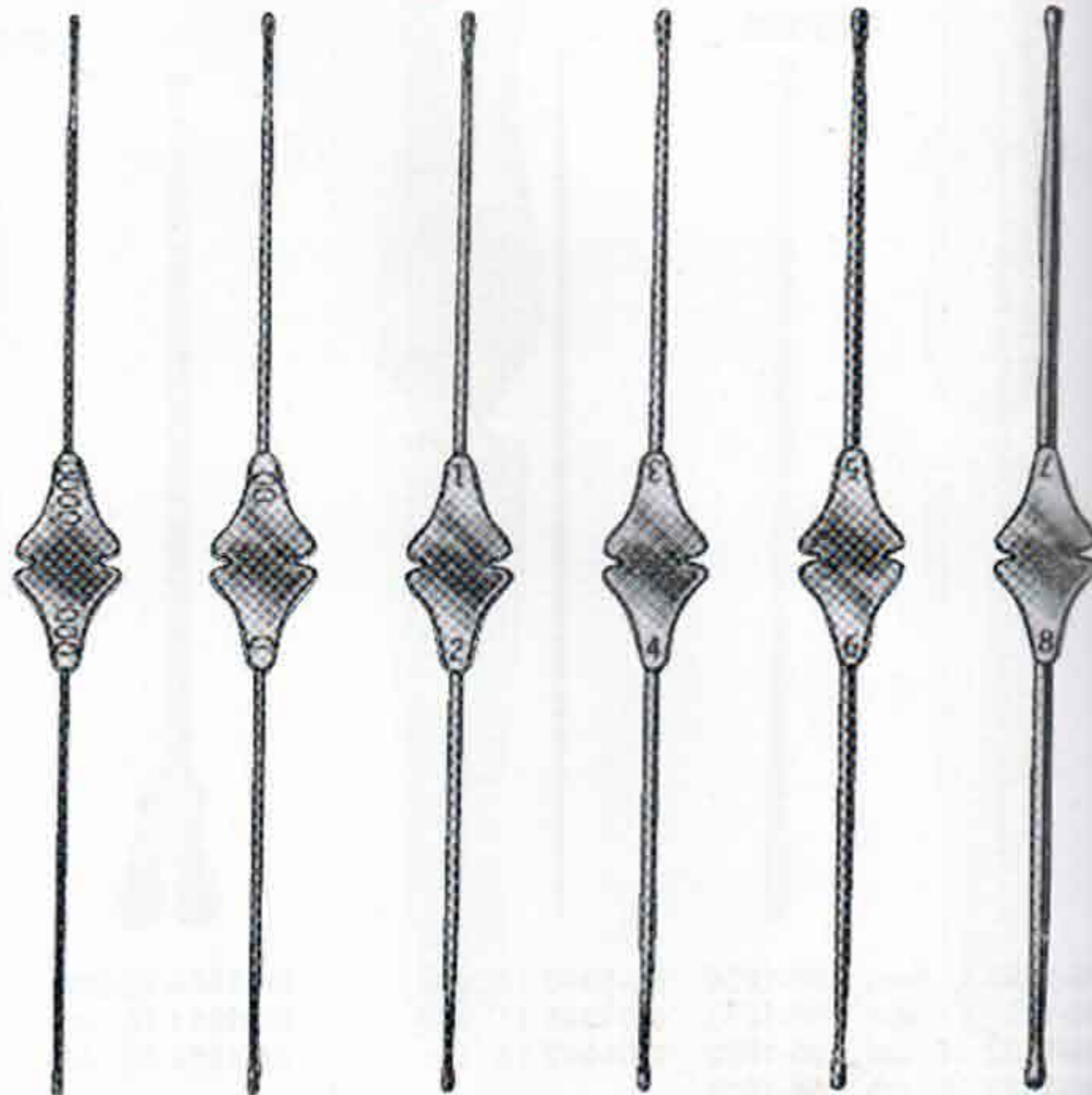

<b>06-1170</b> William Probe, 000-0000	<b>06-1171</b> William Probe, 00-0	<b>06-1172</b> William Probe, 1-2	<b>06-1173</b> William Probe, 3-4	<b>06-1174</b> William Probe, 5-6	<b>06-1175</b> William Probe, 7-8
---	---	--	--	--	--



**06-1180** 14.5 cm, 5 3/4"  
**06-1181** 16.0 cm, 6 1/4"  
**06-1182** 20.0 cm, 8"  
probes with eye



**06-1190**  
14.5 cm, 5 3/4"  
Myrtle leaf probe



**06-1200** 13.0 cm, 5"  
**06-1201** 14.5 cm, 5 3/4"  
**06-1202** 16.0 cm, 6 1/4"  
**06-1203** 18.5 cm, 7"  
**06-1204** 20.0 cm, 8"



**06-1210**  
probe



**06-1220**  
19.0 cm, 8 1/4"  
Double ended probe,  
malleable, diam, of tips  
3 mm with hole



**06-1230** 1.5 mm  
**06-1231** 2.0 mm  
**06-1232** 2.5 mm  
30.0 cm, 12"



# GENERAL INSTRUMENTS

Allgemeines Instrumentarium  
Instrumental general

Instrumentation générale  
Strumentario generale



**DIRECTORS**  
06-1240 13 cm, 5"  
06-1241 14.5 cm, 5 3/4"  
06-1242 16 cm, 6"

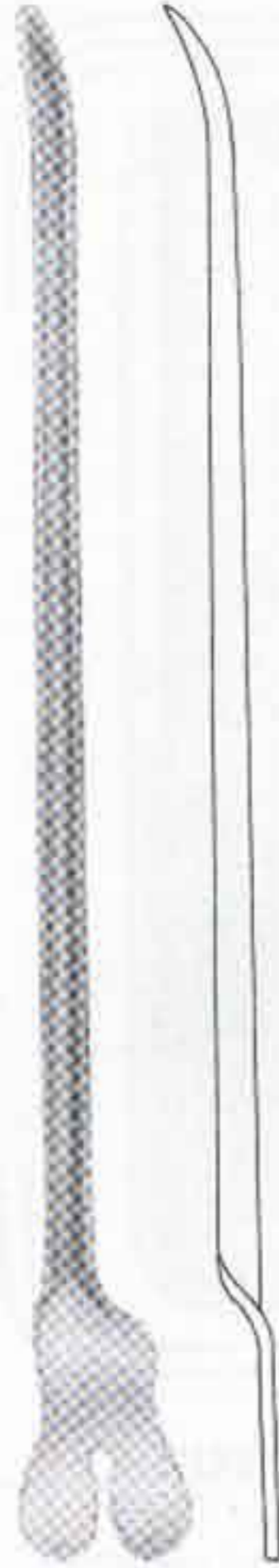

**DOYEN**  
06-1250  
14.5 cm, 5 3/4"

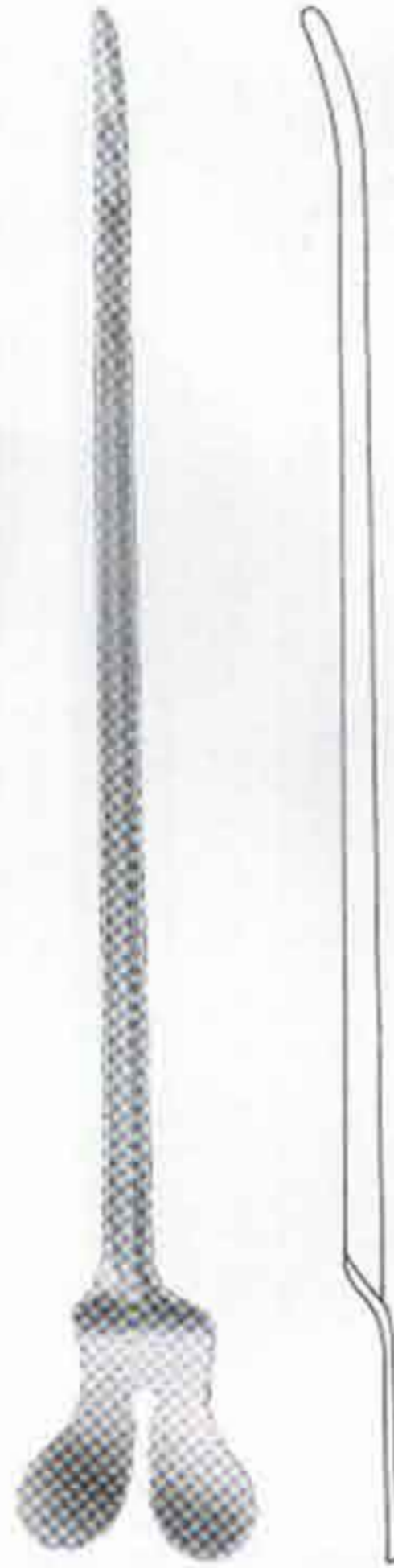

**NELATON**  
06-1260  
16 cm, 6"



**06-1270**  
14 cm, 5 1/2"  
Director with tip  
Diam. Of tip 3.3 mm

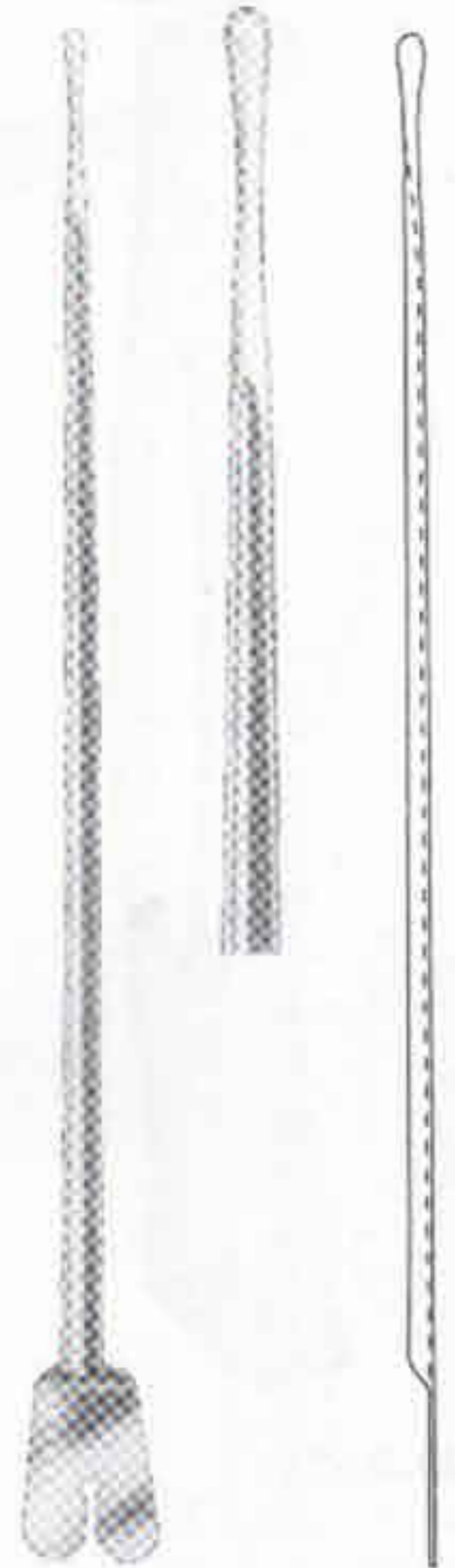

**BRODIE**  
06-1280  
20 cm, 8"  
Director with tip  
Diam. Of tip 3.5 mm

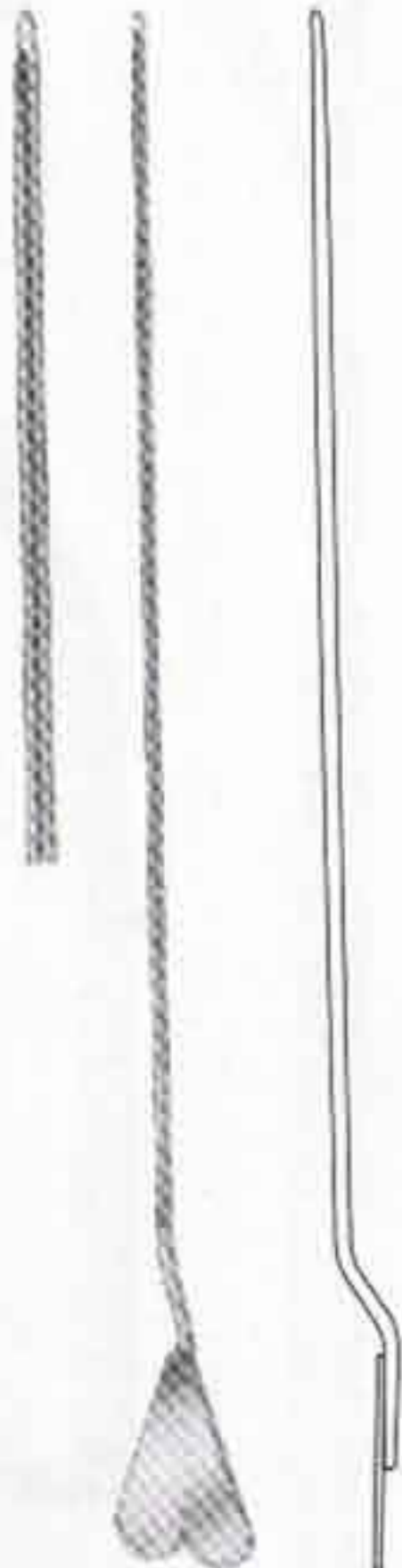

**LOCKHART-MUMMERY**  
06-1290  
16.5 cm, 6 1/2"

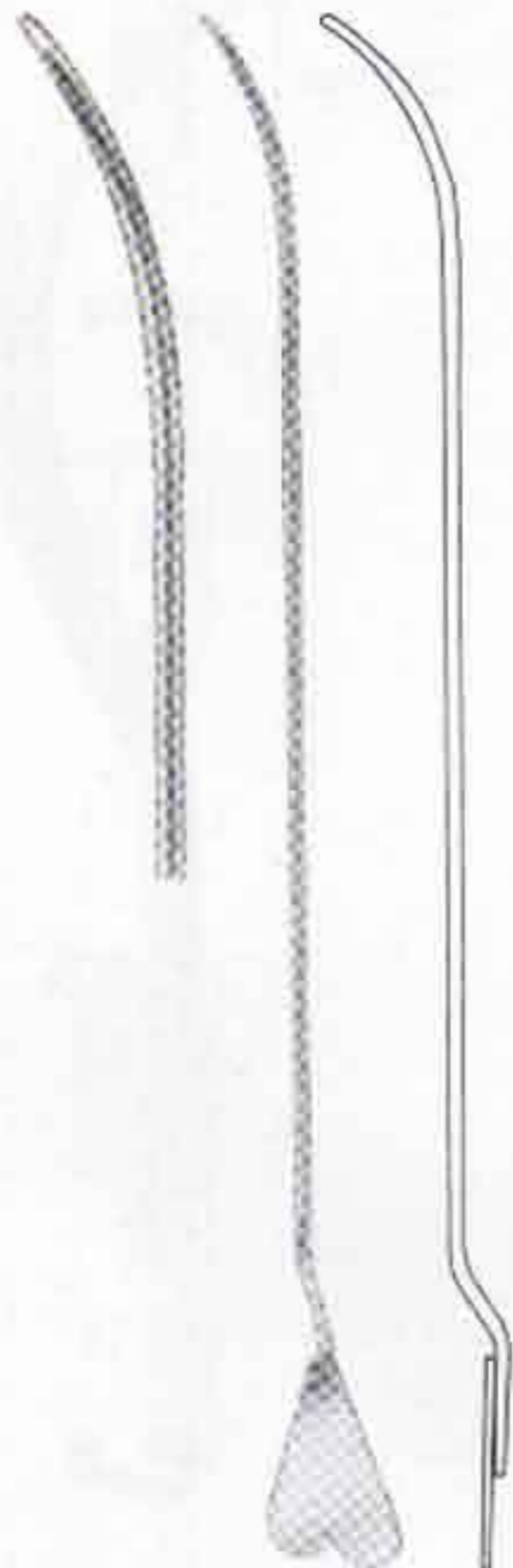

**LOCKHART-MUMMERY**  
06-1300  
16.5 cm, 6 1/2"



**LOCKHART-MUMMERY**  
06-1310  
16.5 cm, 6 1/2"



**LOCKHART-MUMMERY**  
06-1320  
16.5 cm, 6 1/2"



**06-1330**  
19 cm, 7 1/4"  
director with wire  
loop, malleable



# RETRACTORS

Wundhaken  
Separadores

Ecarteurs  
Divaricatori

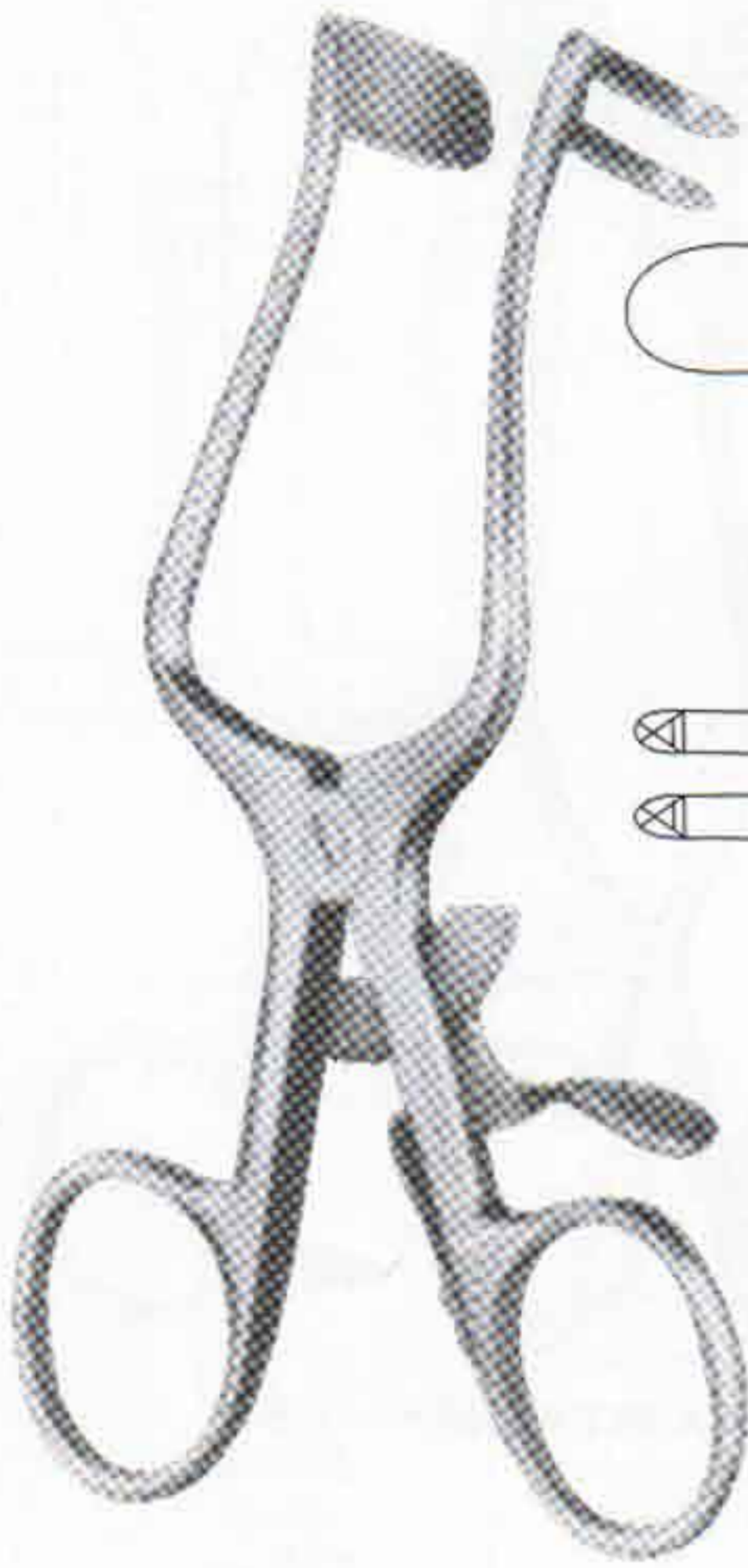

**PLESTER**

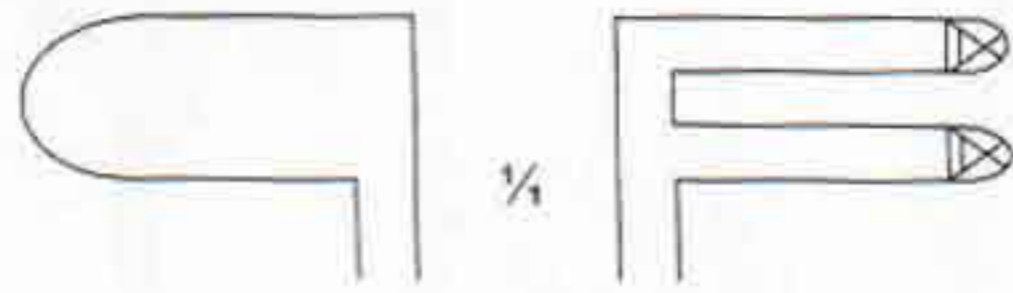

**07-720**  
11 cm, 4 1/2"  
fig. 1 Blunt

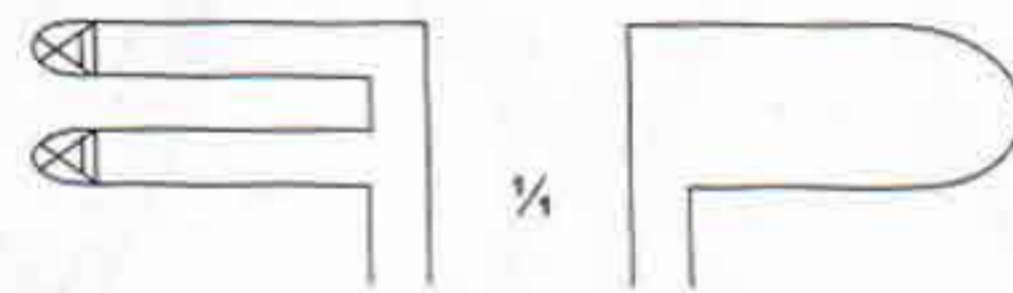

**07-721**  
11 cm, 4 1/2"  
fig. 2 Blunt



**GELPI**  
Vaginal Retractor  
**07-730**  
13.5 cm, 5"



**GELPI**  
Skin- and Vaginal Retractor  
**07-740**  
17.5 cm, 7"



CLOWARD modif.  
**07-750**  
Spreader Only



**07-751**



**07-752**



**07-753**



**07-754**



**07-755**



**07-756**



**07-757**



**07-758**



**07-759**



**07-760**



# RETRACTORS

Wundhaken  
Separadores

Ecarteurs  
Divaricatori

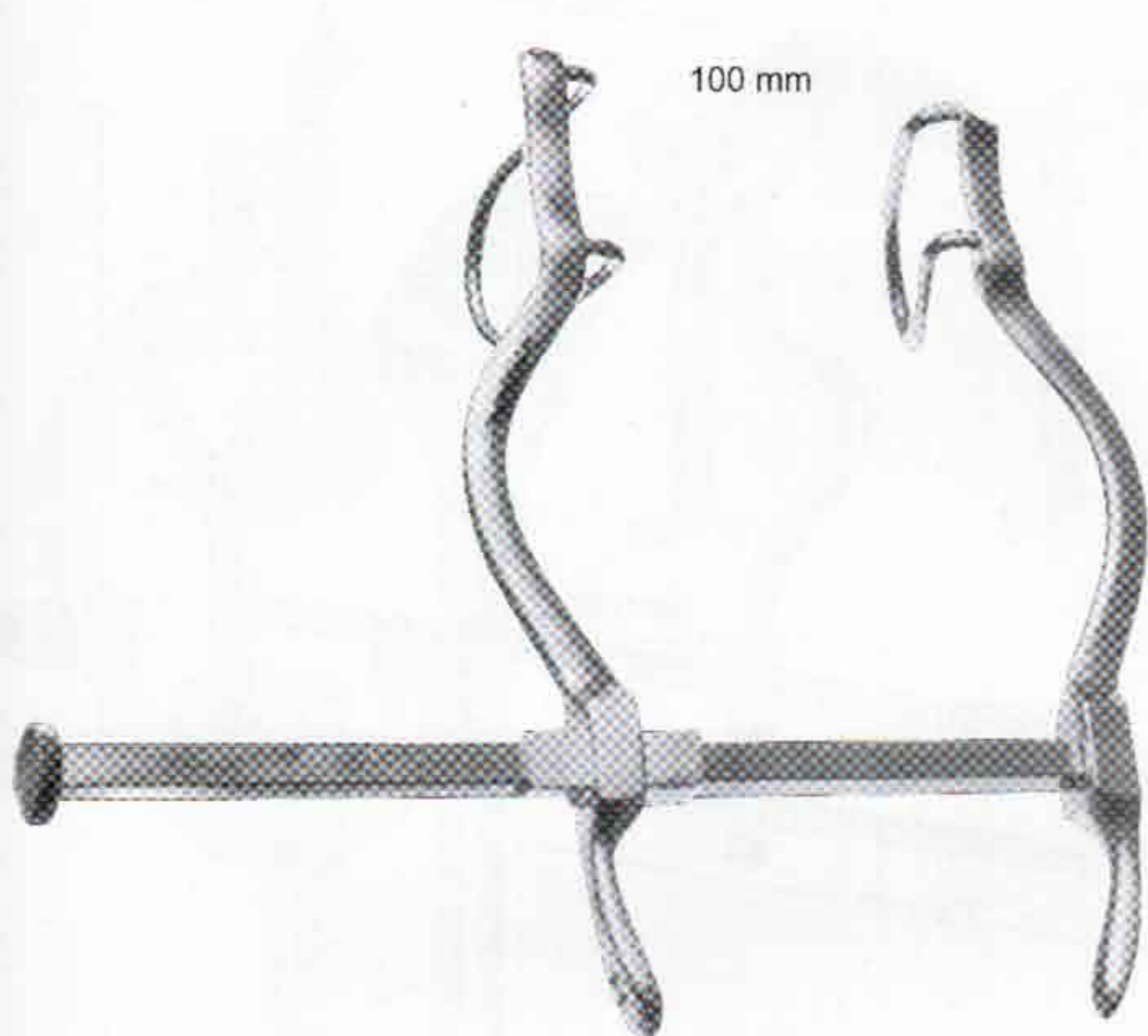

**GOSSET**  
**07-770**  
Center Blades 40 x 30 mm

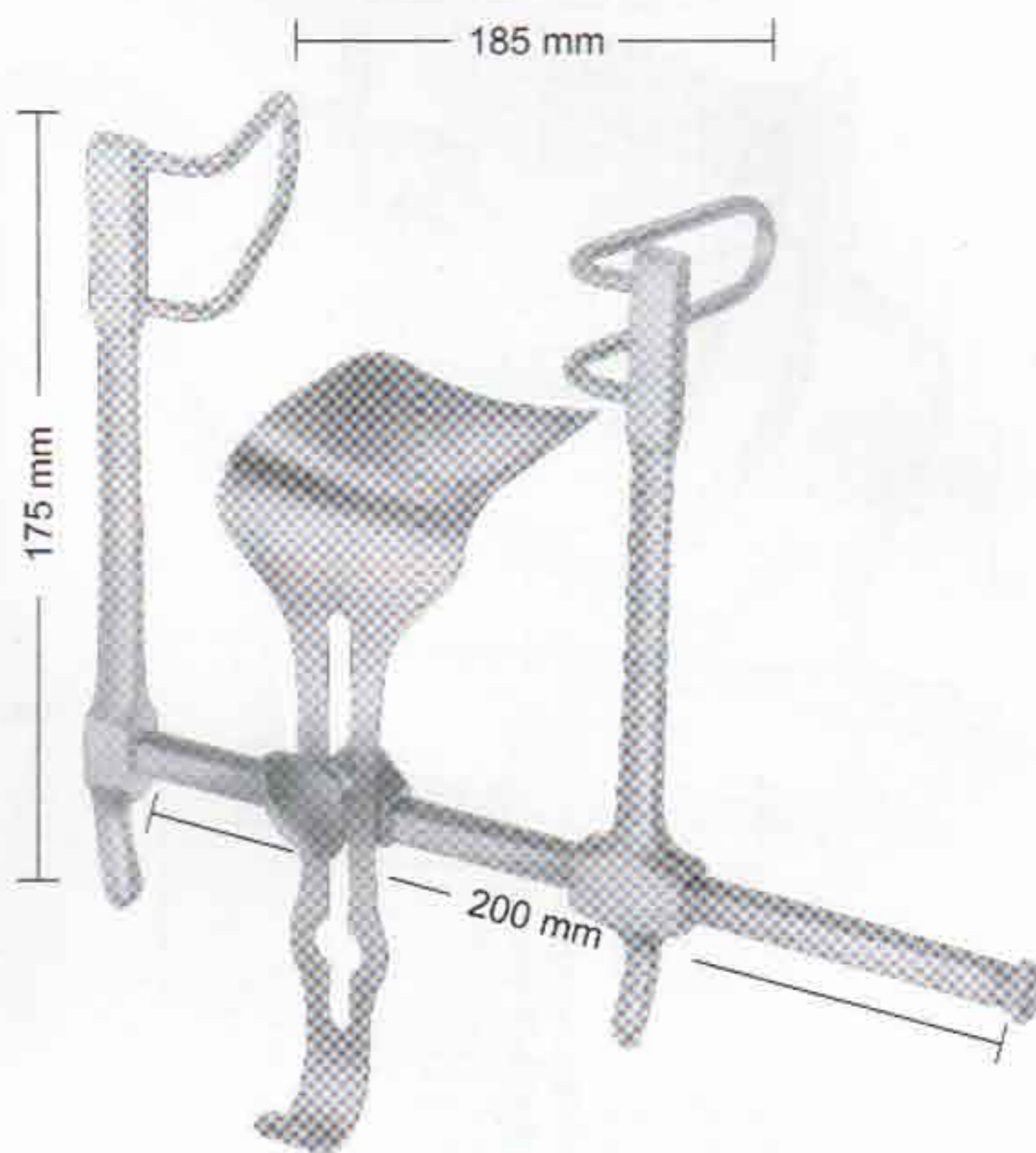

**GOSSET**  
**07-780**  
Lateral Blades 58 mm deep  
Center blade 59 x 57 mm

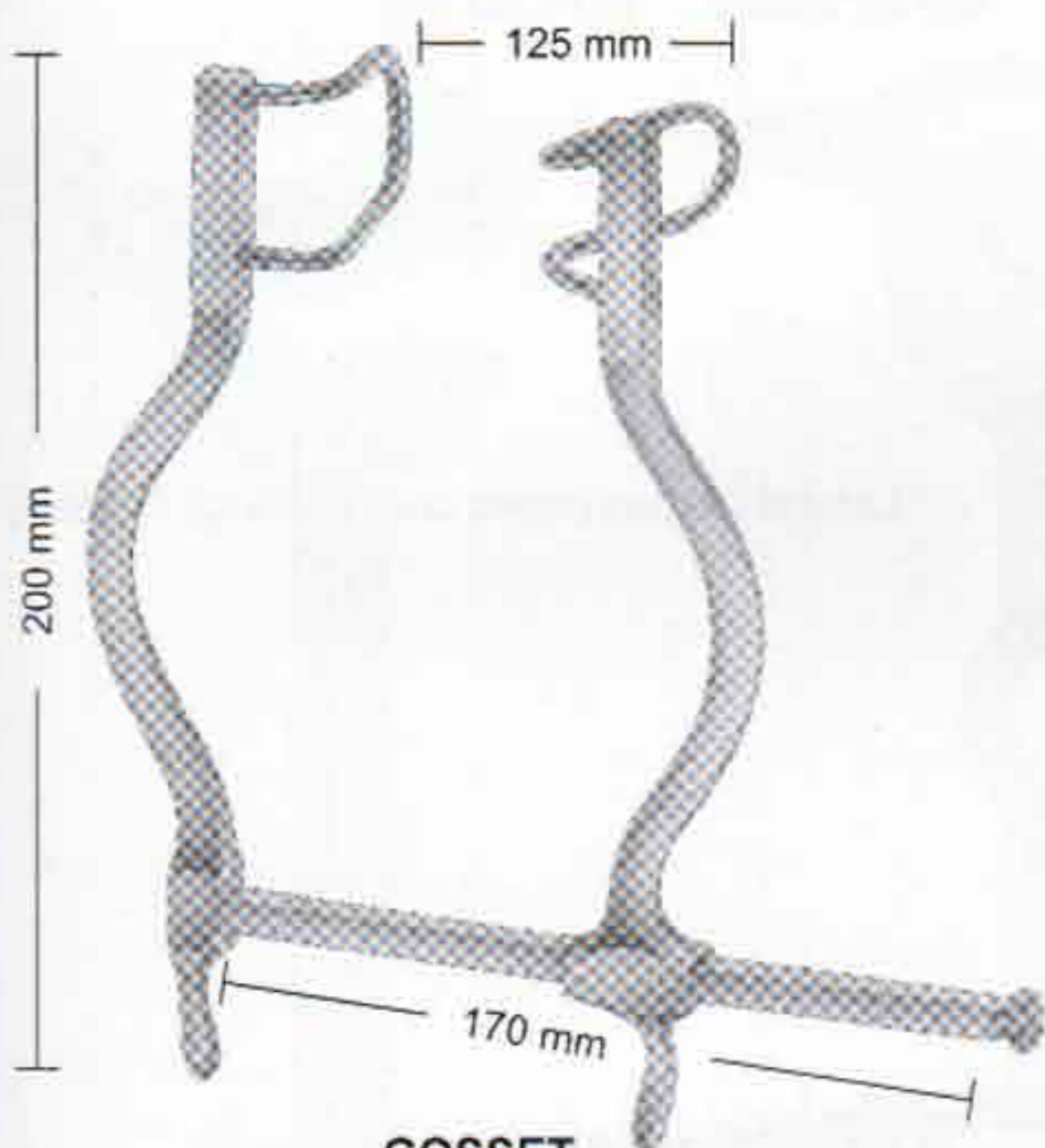

**GOSSET**  
**07-790**  
Blades: 55mm deep

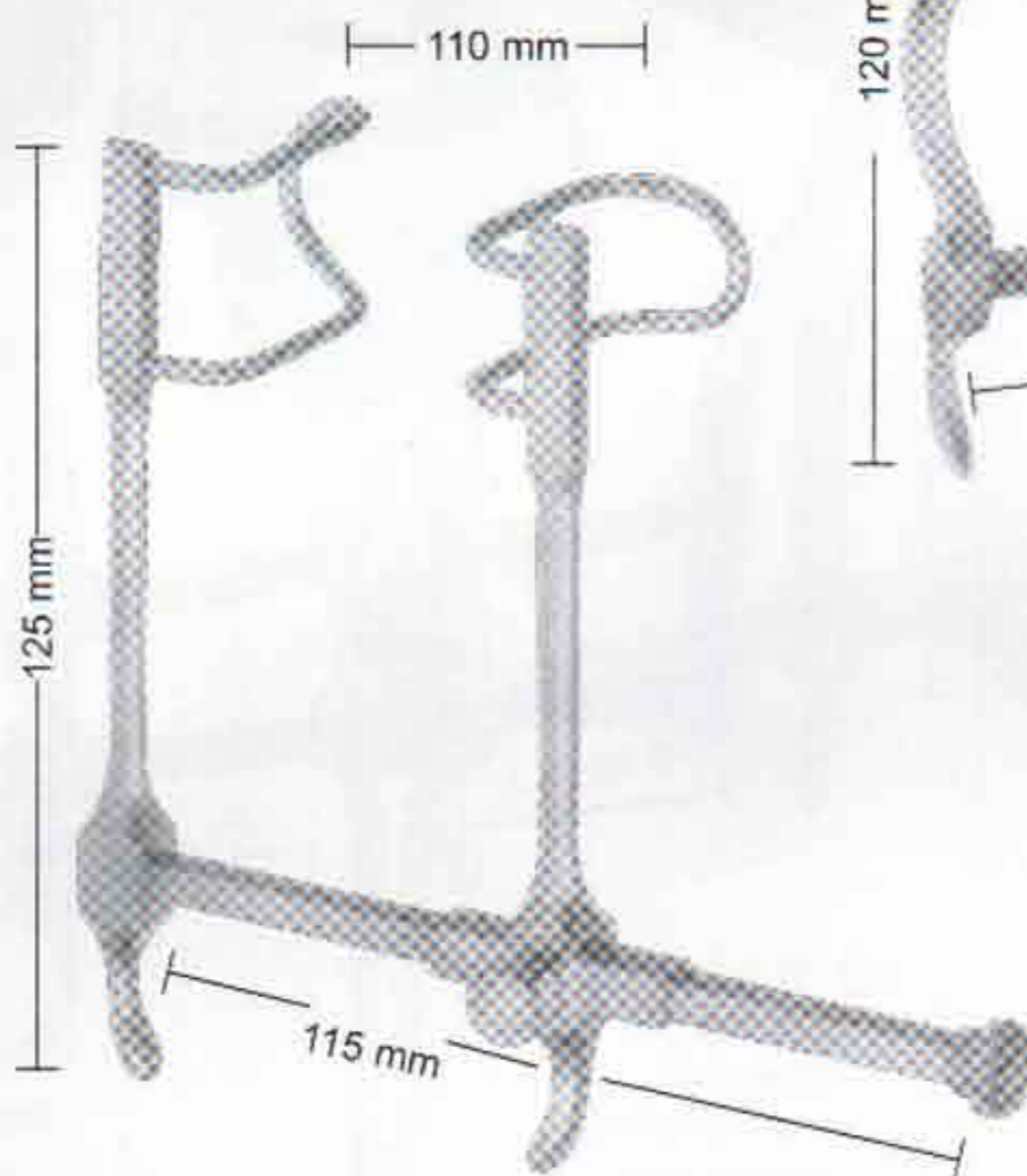

**GOSSET**  
**07-800**  
Blades: 38 mm deep

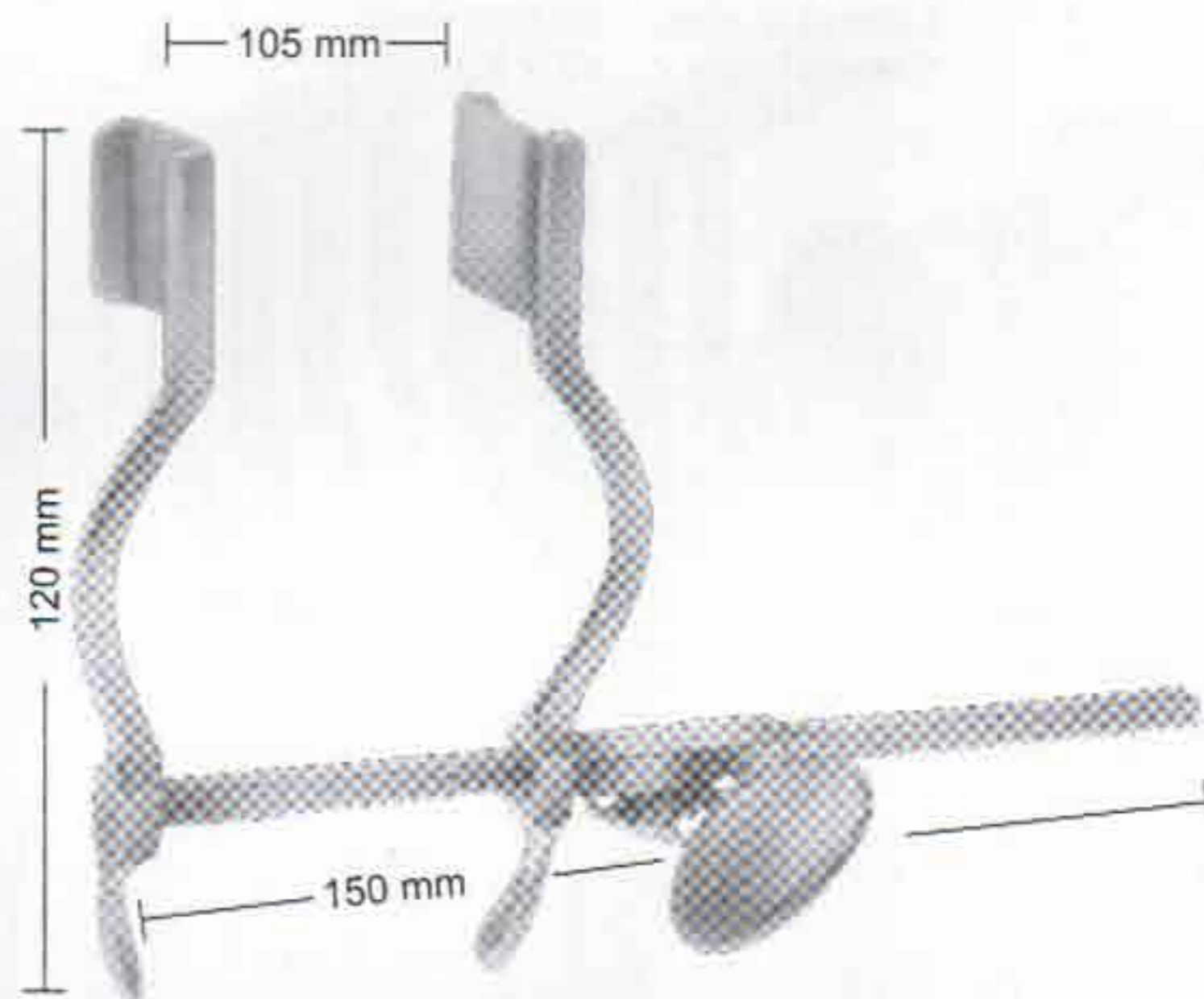

**HERTZLER**  
**07-810**  
Blades 20 x 25 mm



# RETRACTORS

Wundhaken  
Separadores

Ecarteurs  
Divaricatori

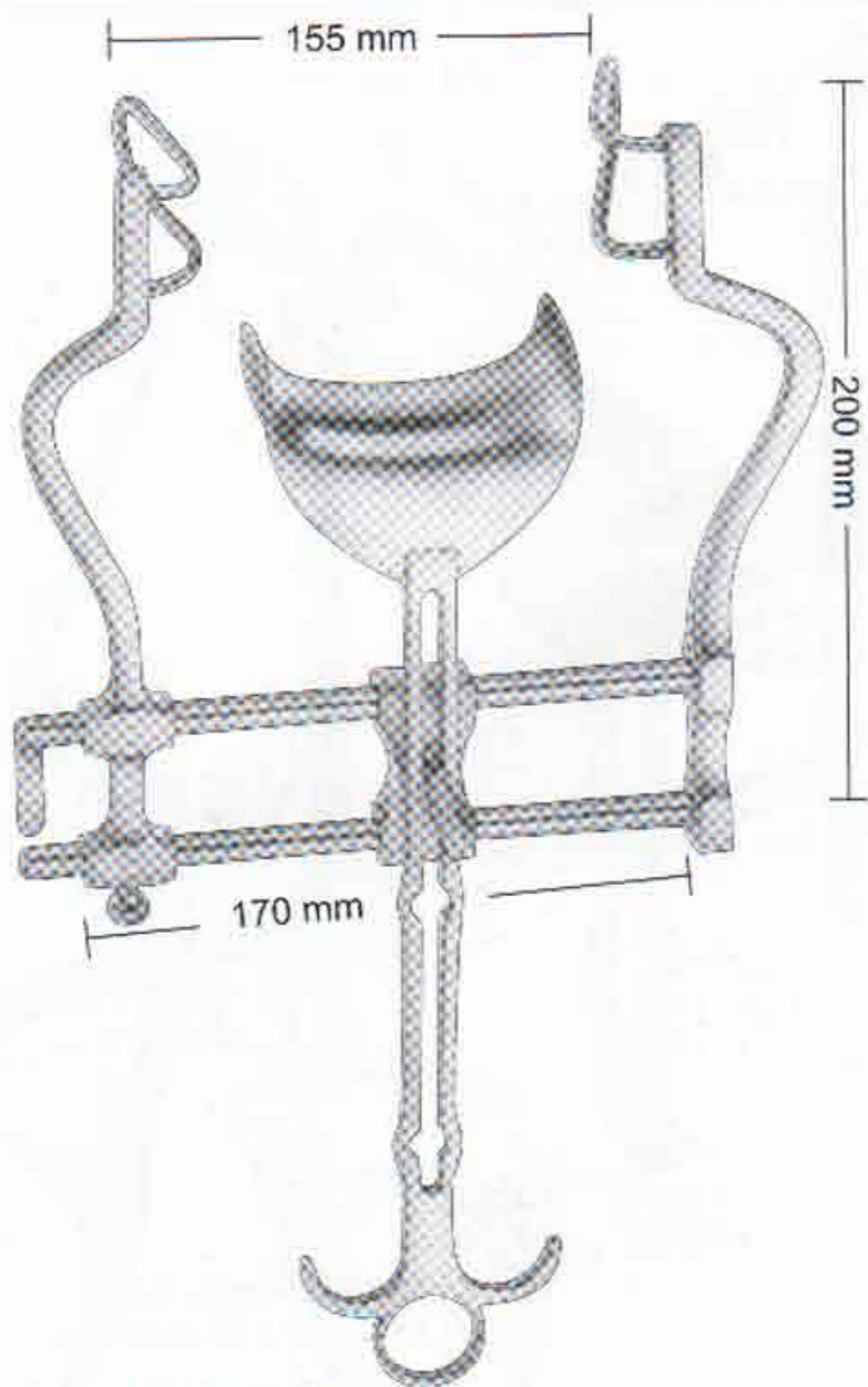

**BALFOUR  
07-820**  
Lateral blades 60 mm deep  
Center blade 47 x 80 mm

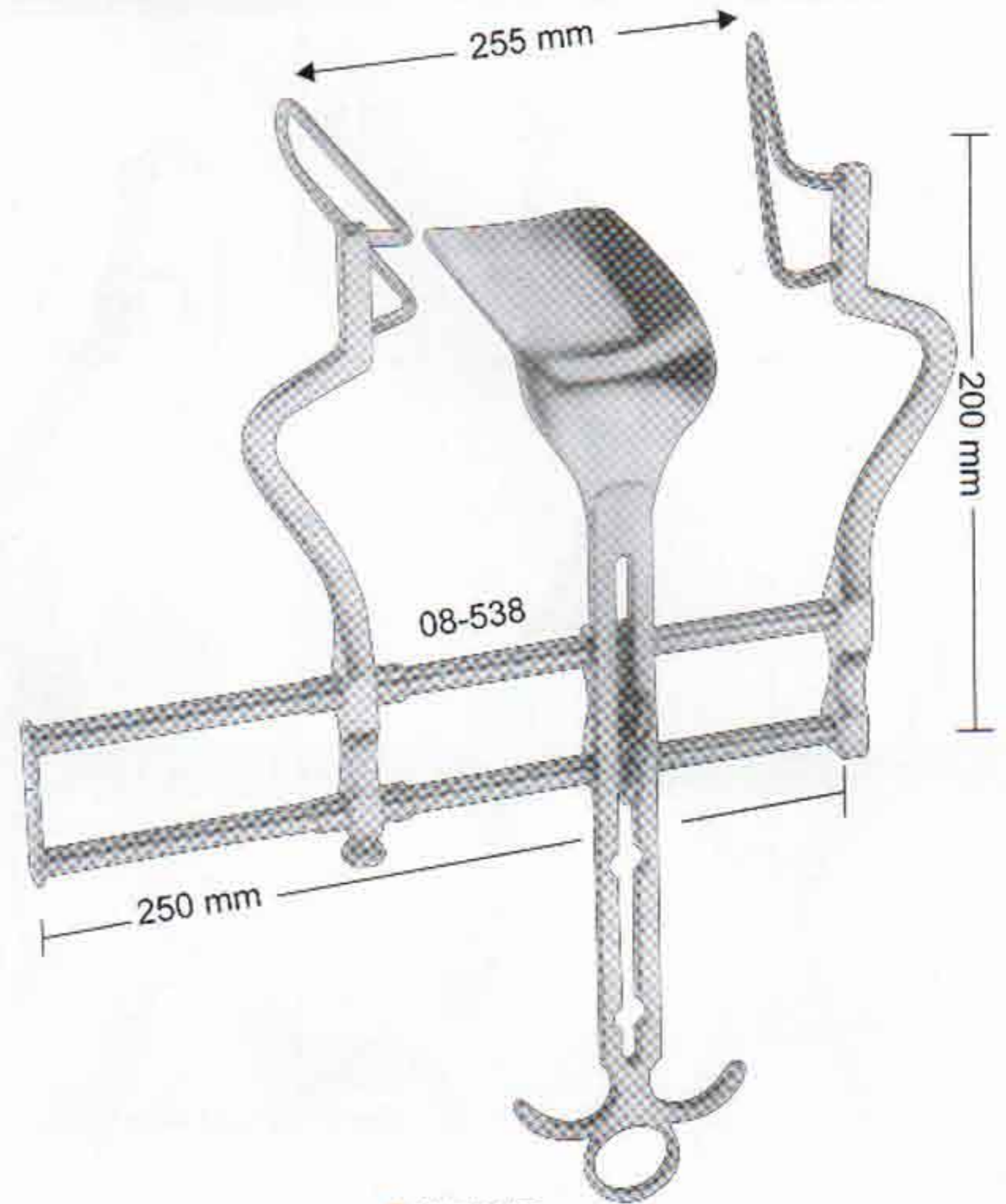

**BALFOUR  
07-830**  
Lateral blades 105 mm deep  
Center blade 107 x 59 mm

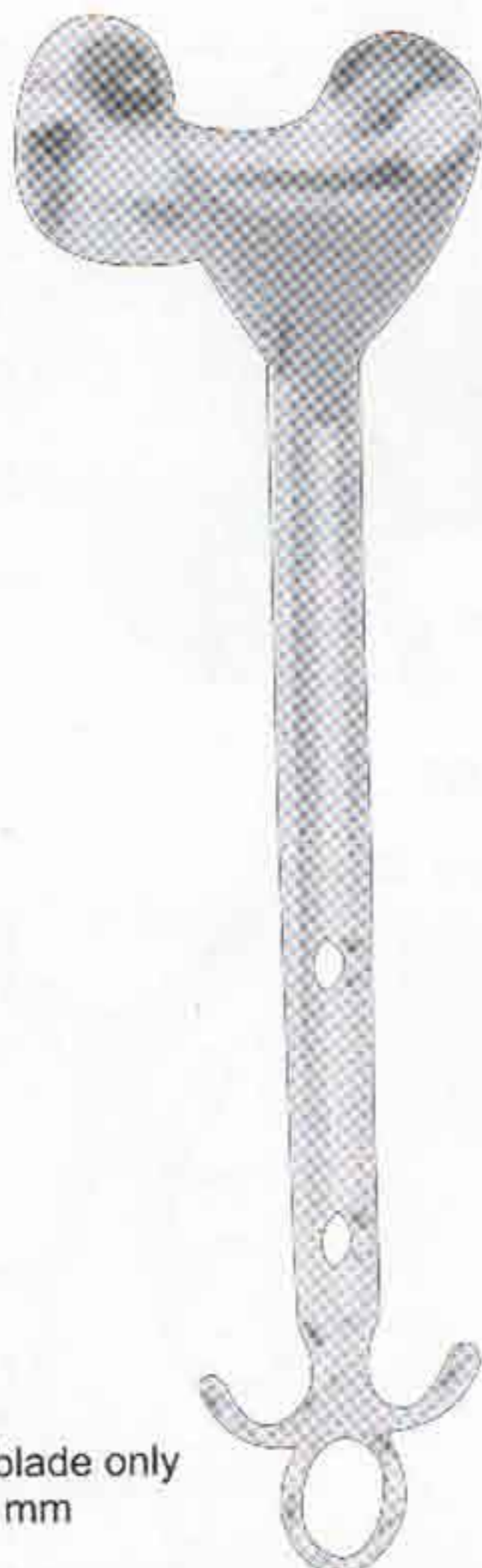

**07-840**  
Center blade only  
54 x 80 mm

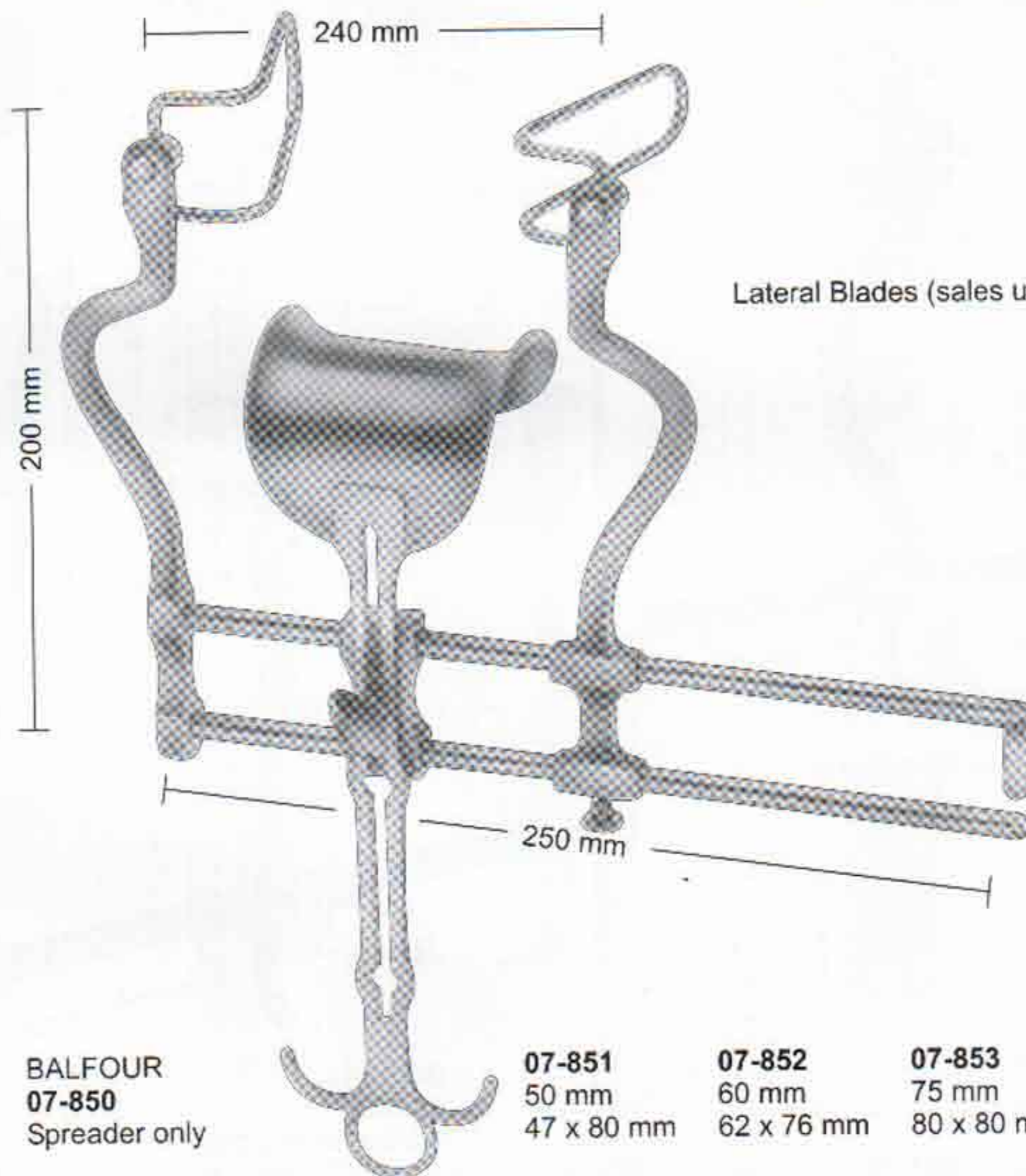

**BALFOUR  
07-850**  
Spreader only

<b>07-851</b> 50 mm 47 x 80 mm	<b>07-852</b> 60 mm 62 x 76 mm	<b>07-853</b> 75 mm 80 x 80 mm	<b>07-854</b> 90 mm 80 x 80 mm
--------------------------------------	--------------------------------------	--------------------------------------	--------------------------------------

Lateral Blades (sales unit of blades in pairs)



# RETRACTORS

Wundhaken  
Separadores

Ecarteurs  
Divaricatori



### O'SULLIVAN/O'CONNOR

- 07-860 (Set includes frame & 3 blades)
- 07-861 Frame Only (not pictured)



**07-862**  
Single Retractor Blade  
110 x 70 mm

**07-863**  
Set of 2 Retractor Blade  
80 x 45 mm

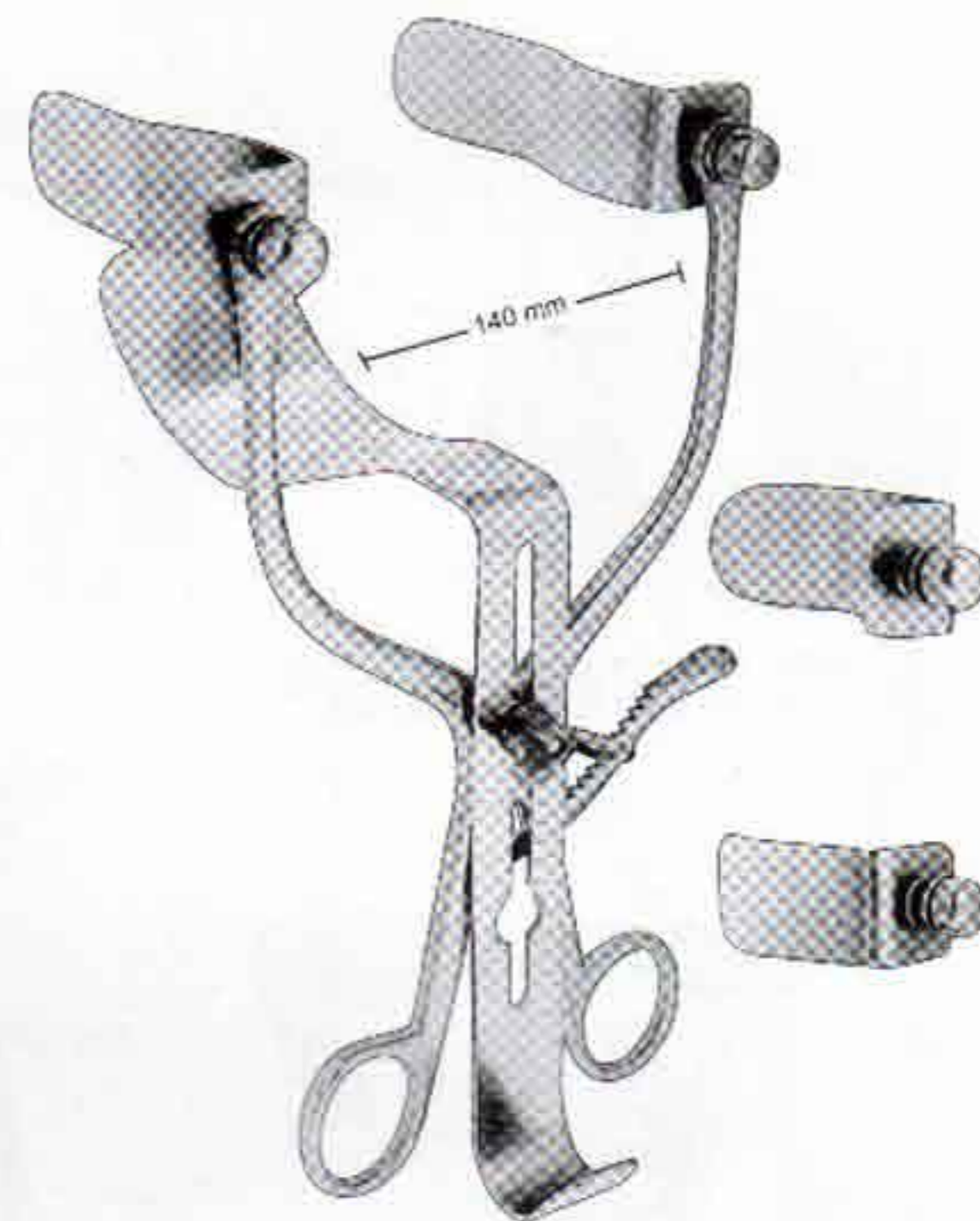

### COLLIN

- 07-870 Complete
- 07-871 Spreader only
- 07-872 Blades 55 x 25 mm
- 07-873 Blades 80 x 25 mm
- 07-874 Center Blade  
115 x 45 mm



**07-880**  
Center Blade  
45 x 80 mm  
70 x 85 mm

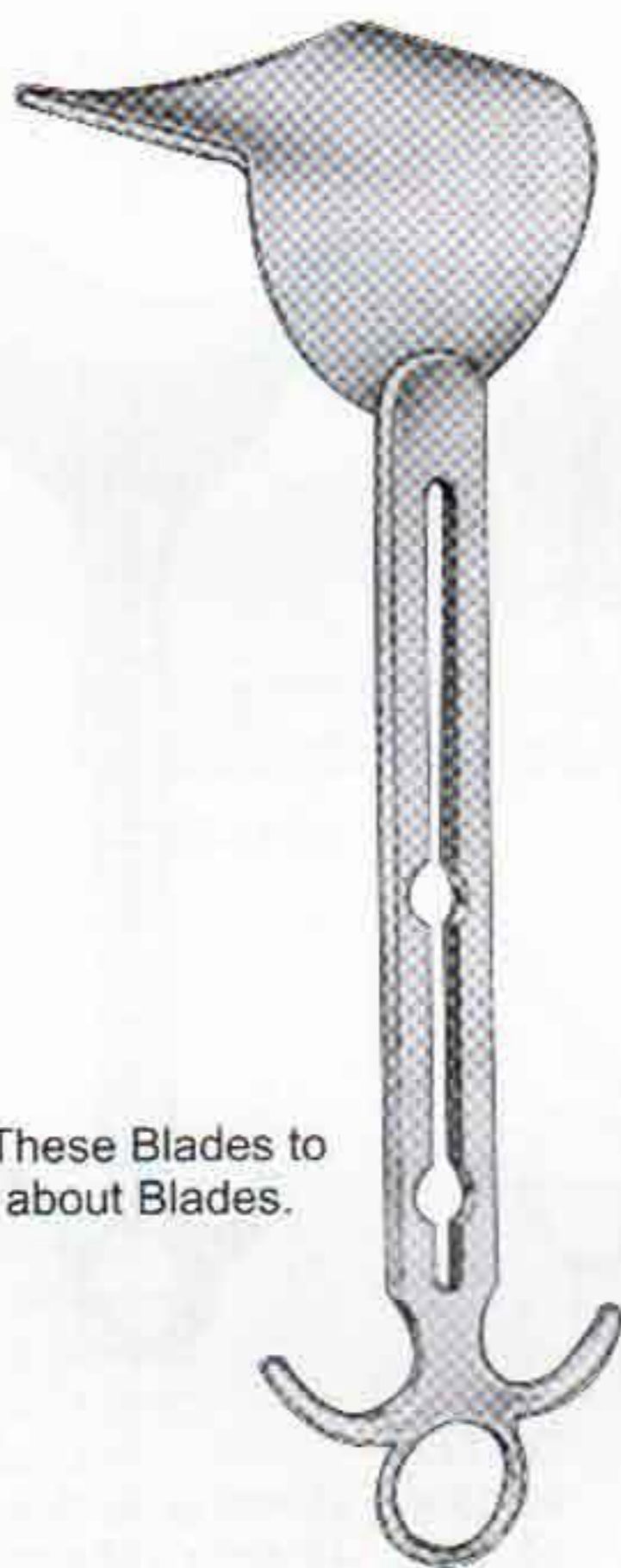

**07-890**  
Center Blade  
100 x 60 mm

Sizes of These Blades to Same as about Blades.

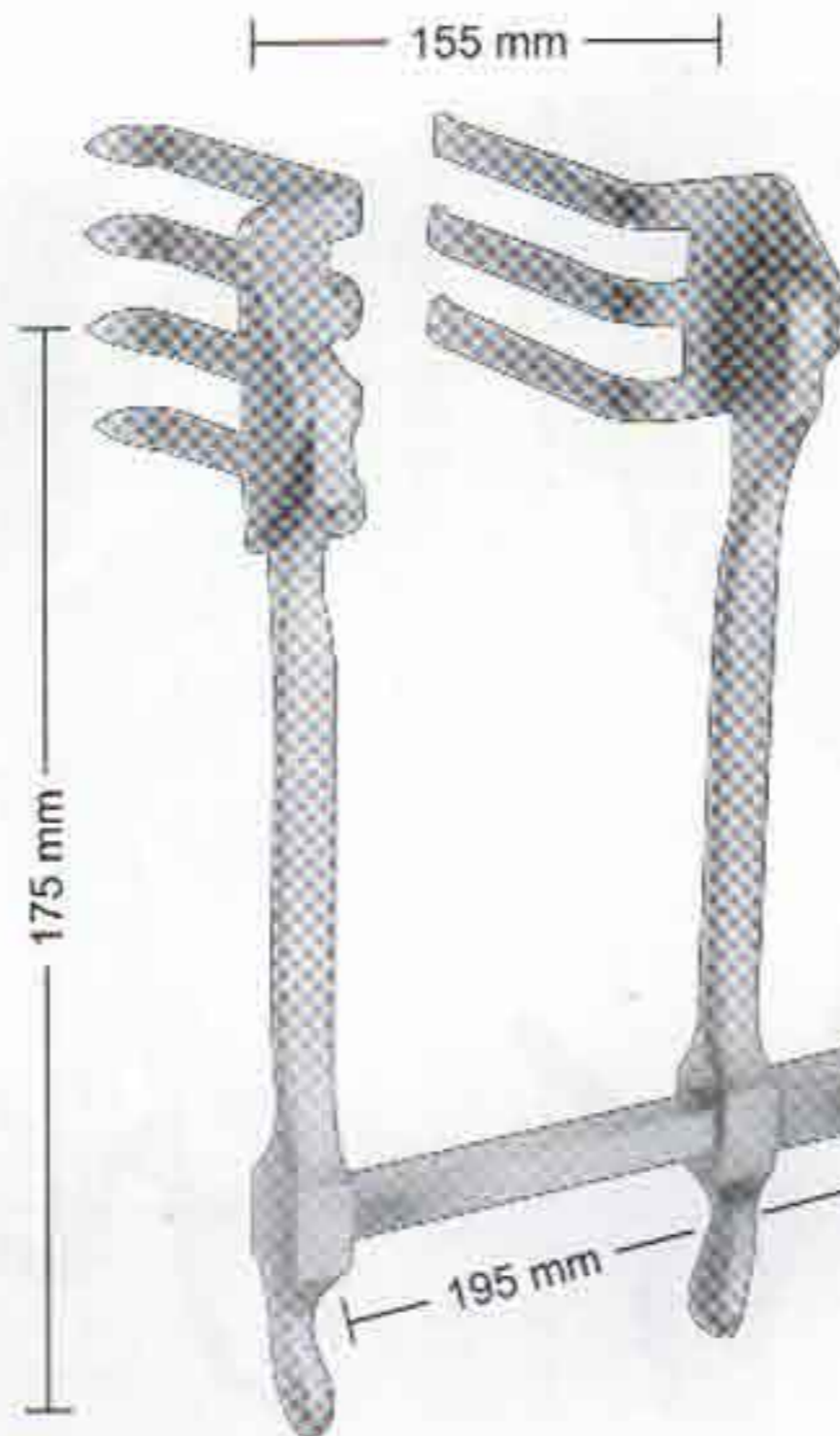

### SCOVILLE-RICHTER

- 07-900 Complete with 1 pair blades.
- 07-901 Frame only. The Retractor bar and shanks may be easily rotates 180 when blades are in situ.

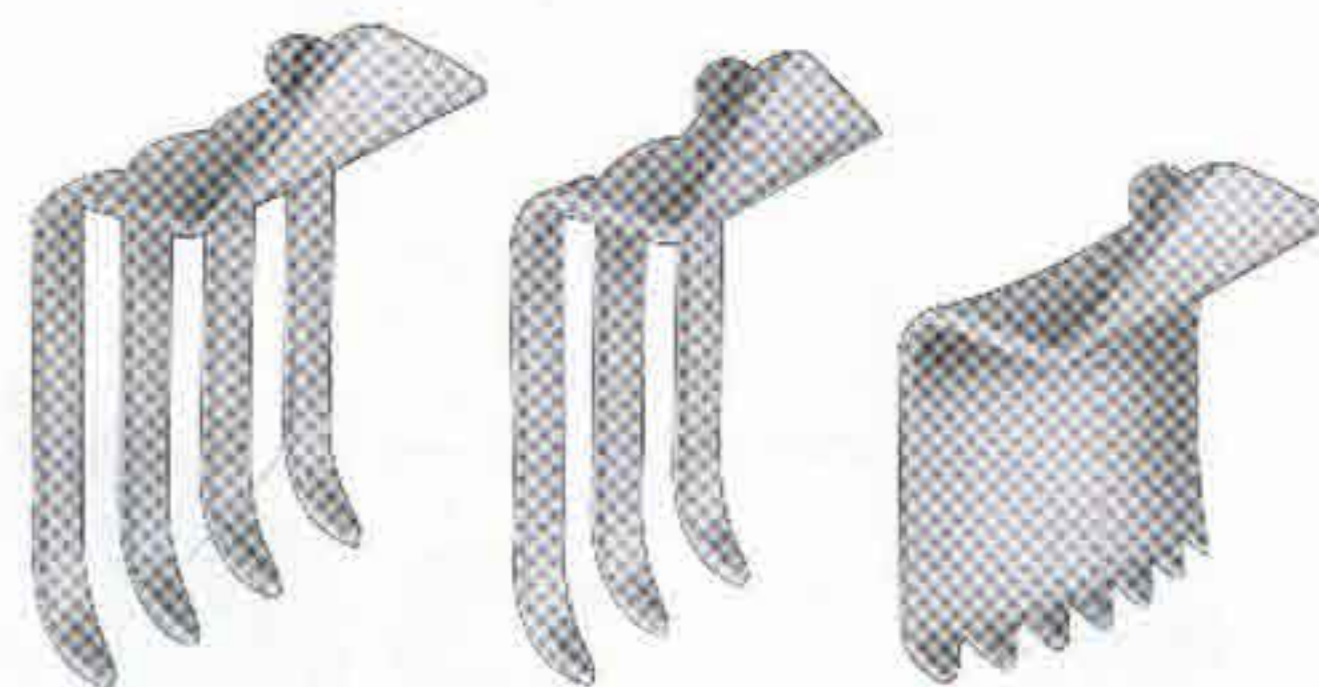

**07-902**  
62 x 52 mm

**07-903**  
62 x 37 mm

**07-903**  
47 x 51 mm

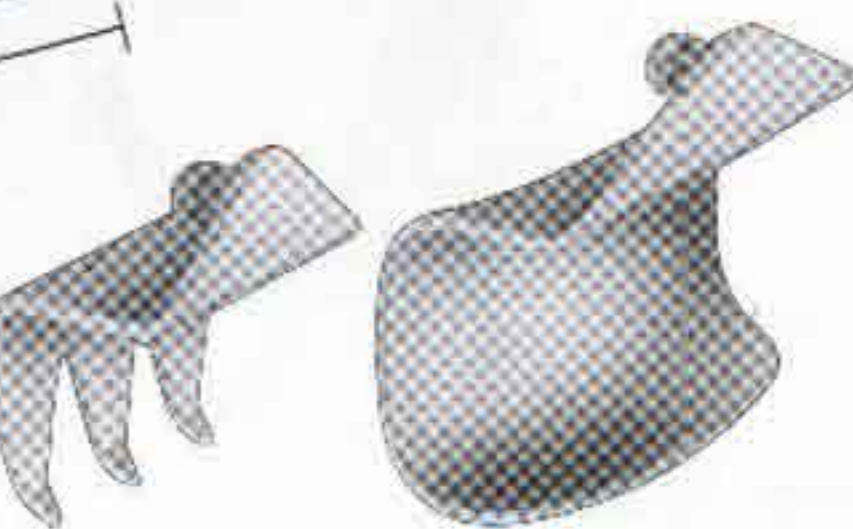

**07-904**  
30 x 40 mm

**07-905**  
37 x 62 mm



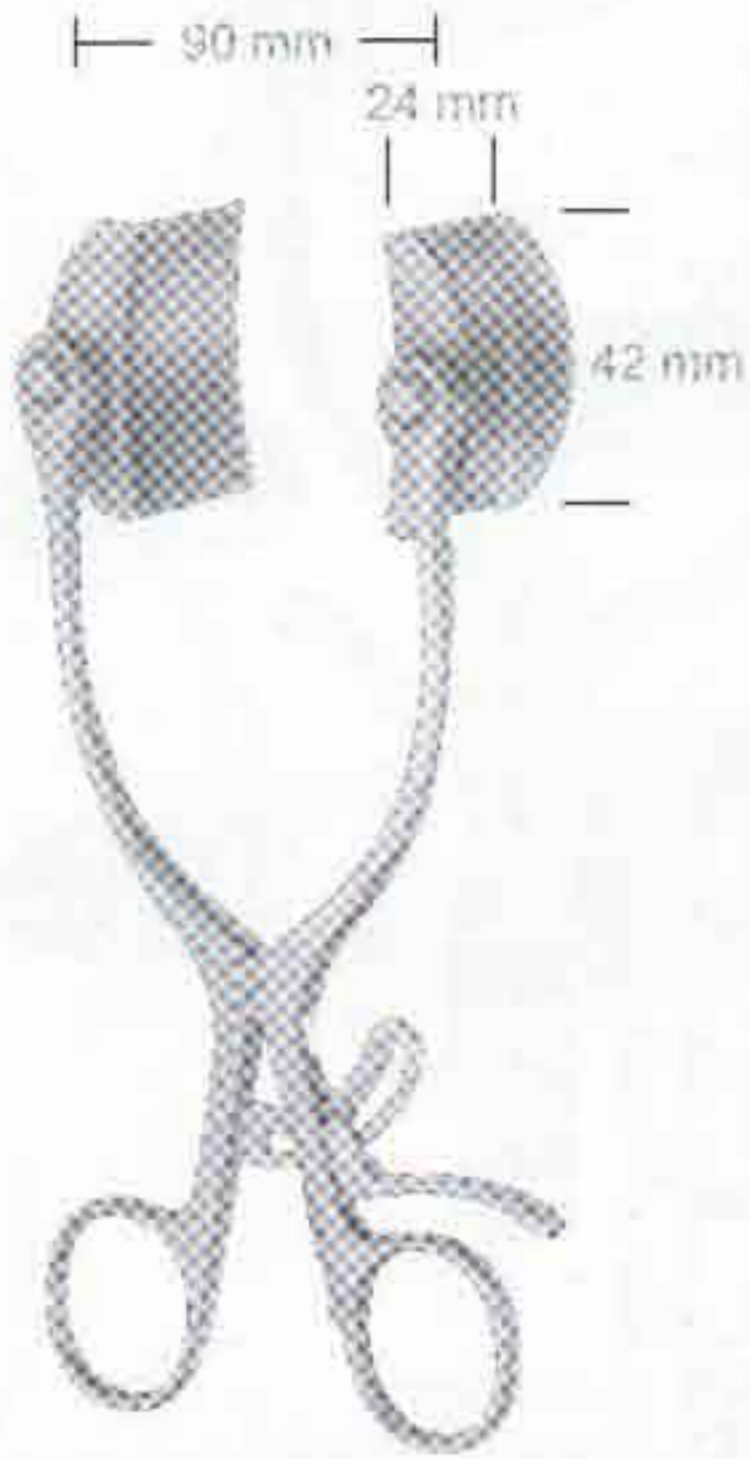

**BABY-COLLIN**  
07-910  
with 2 pair of blades

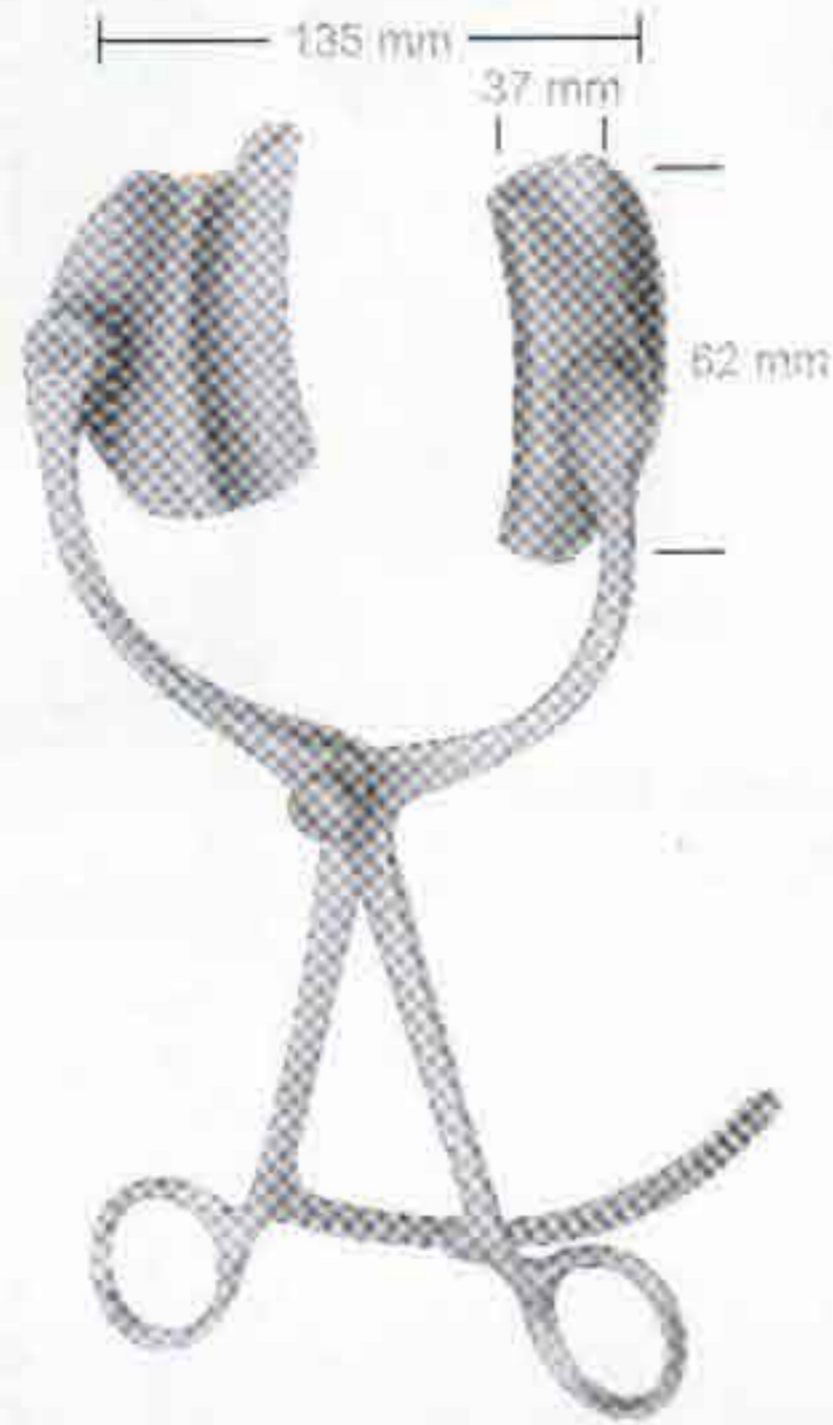

**COLLIN**  
07-920  
complete



**COLLIN**  
07-930  
Spreader Only



**RICARD**  
07-950 Complete  
07-951 Spreader only

Lateral blade	07-952	07-954
	58x80mm	72x84mm
Center blade	07-953	07-955
	54x70mm	72x90mm

Lateral blade	07-931	07-933	07-935
	37x62mm	37x80mm	37x98mm
Center blade	07-932	07-934	07-936
	54x55mm	54x67mm	52x76mm



**HOLZBACH**  
07-970 Complete  
07-971 Spreader only  
07-972 Lateral blade 59x80mm  
07-973 Center blade 74x82mm



**COLLIN**  
07-980 20 cm, 8"  
complete with 2 lateral  
blades and central blade

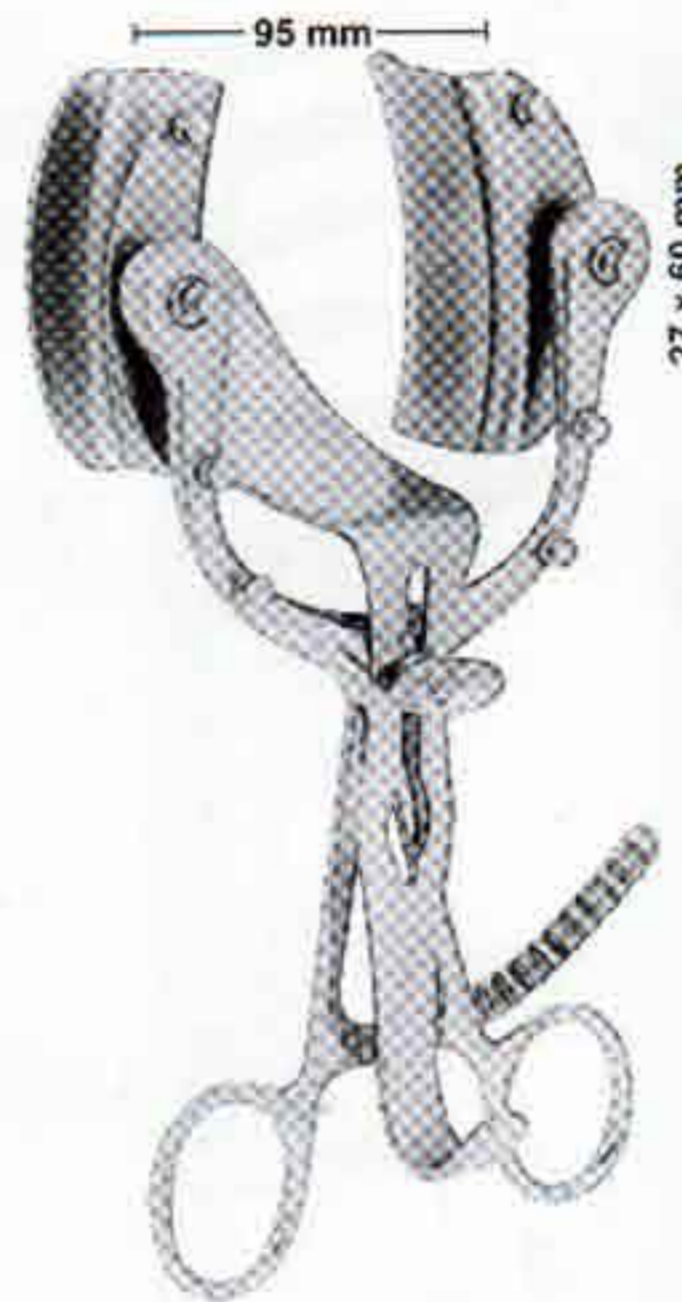

**LEGUEU**  
07-990  
17 cm, 6 3/4"

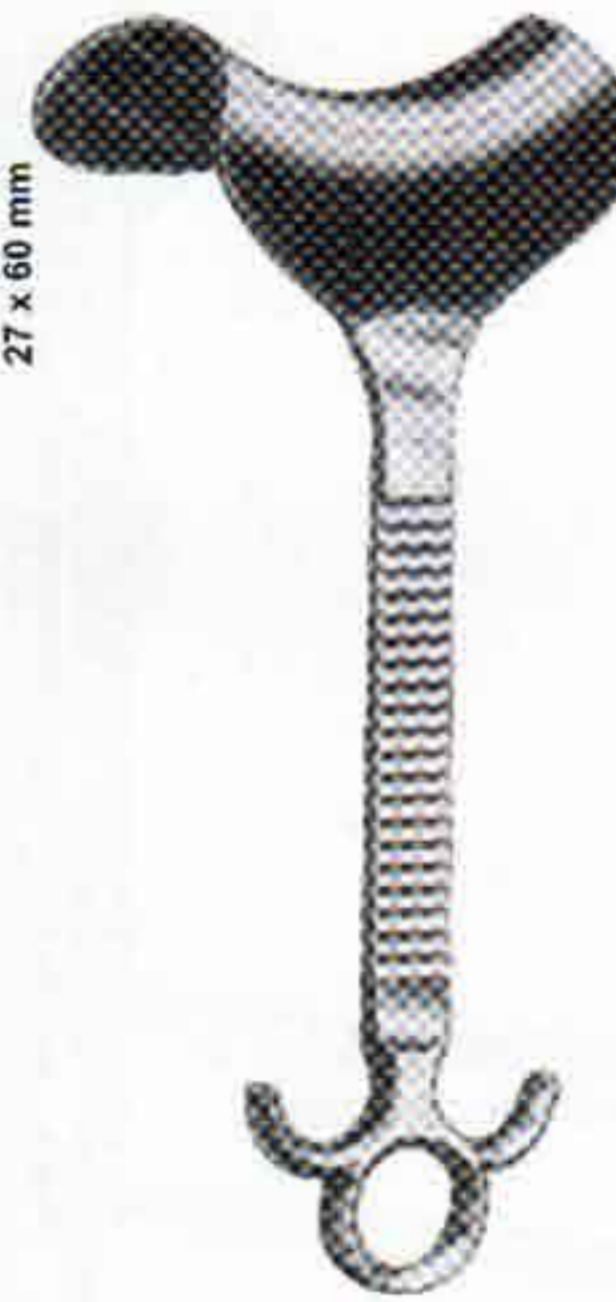

**DOYEN**  
07-1000 48 mm x 90 mm  
07-1001 48 mm x 105 mm  
07-1002 48 mm x 120 mm  
07-1003 48 mm x 135 mm  
28 cm, 11"



**ROCHARD**  
07-1010 48 mm x 90 mm  
07-1011 48 mm x 105 mm  
07-1012 48 mm x 120 mm  
07-1013 48 mm x 135 mm  
07-1014 48 mm x 155 mm  
31 cm, 12"



# RETRACTORS

Wundhaken  
Separadores

Ecarteurs  
Divaricatori

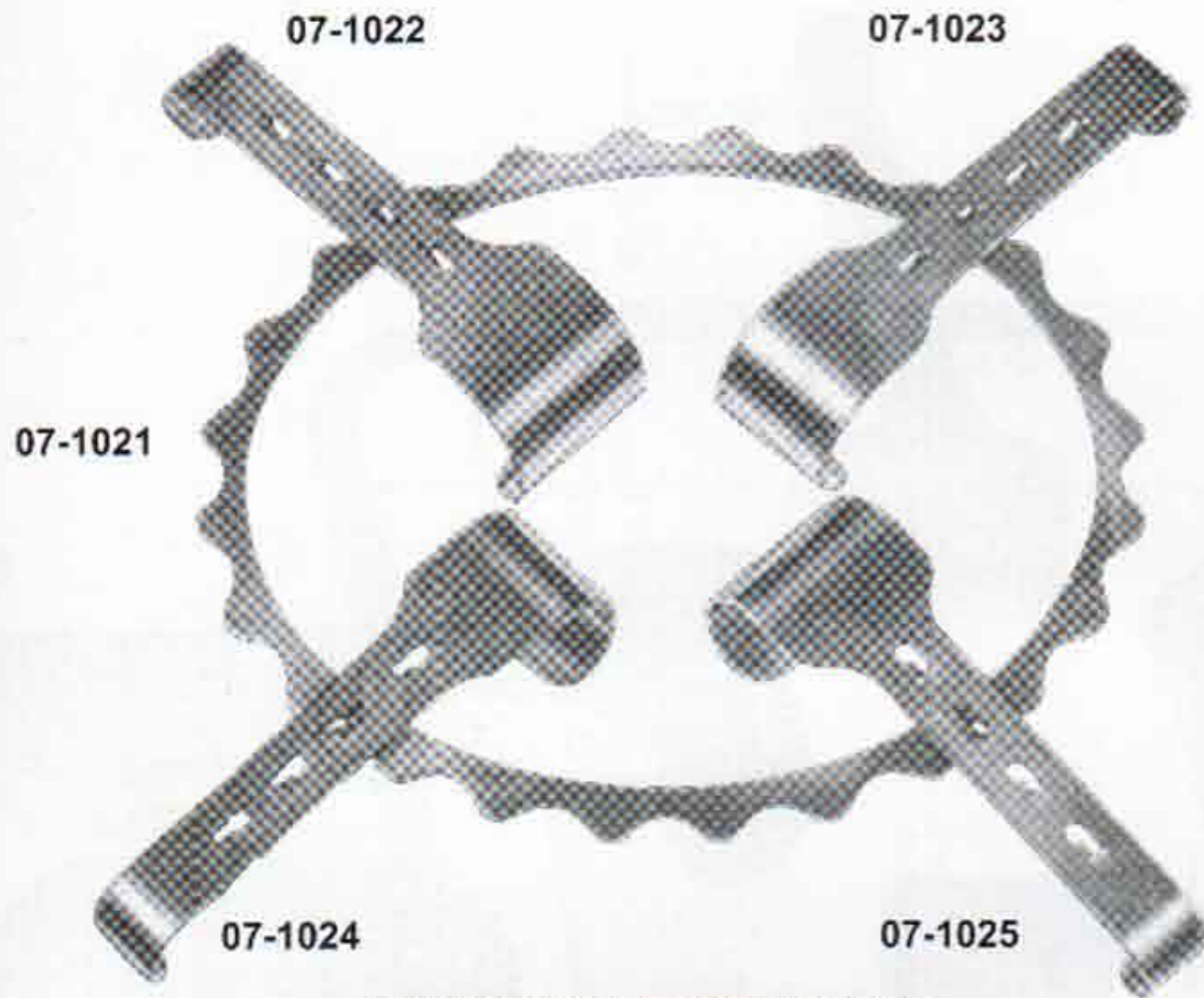

## DENIS-BROWNE

07-1020 Complete with 4 blades

07-1021 Frame 190 x 160 mm

07-1022 2 blades only 40 x 30 mm

07-1023 2 blades only 40 x 40 mm

07-1024  
Blades only 20 x 30 mm



07-1025  
Blades only 20 x 40 mm



## ABDOMINAL RETRACTORS for new-born and children

## ABDOMINAL RETRACTORS well suitable for gynaecologists

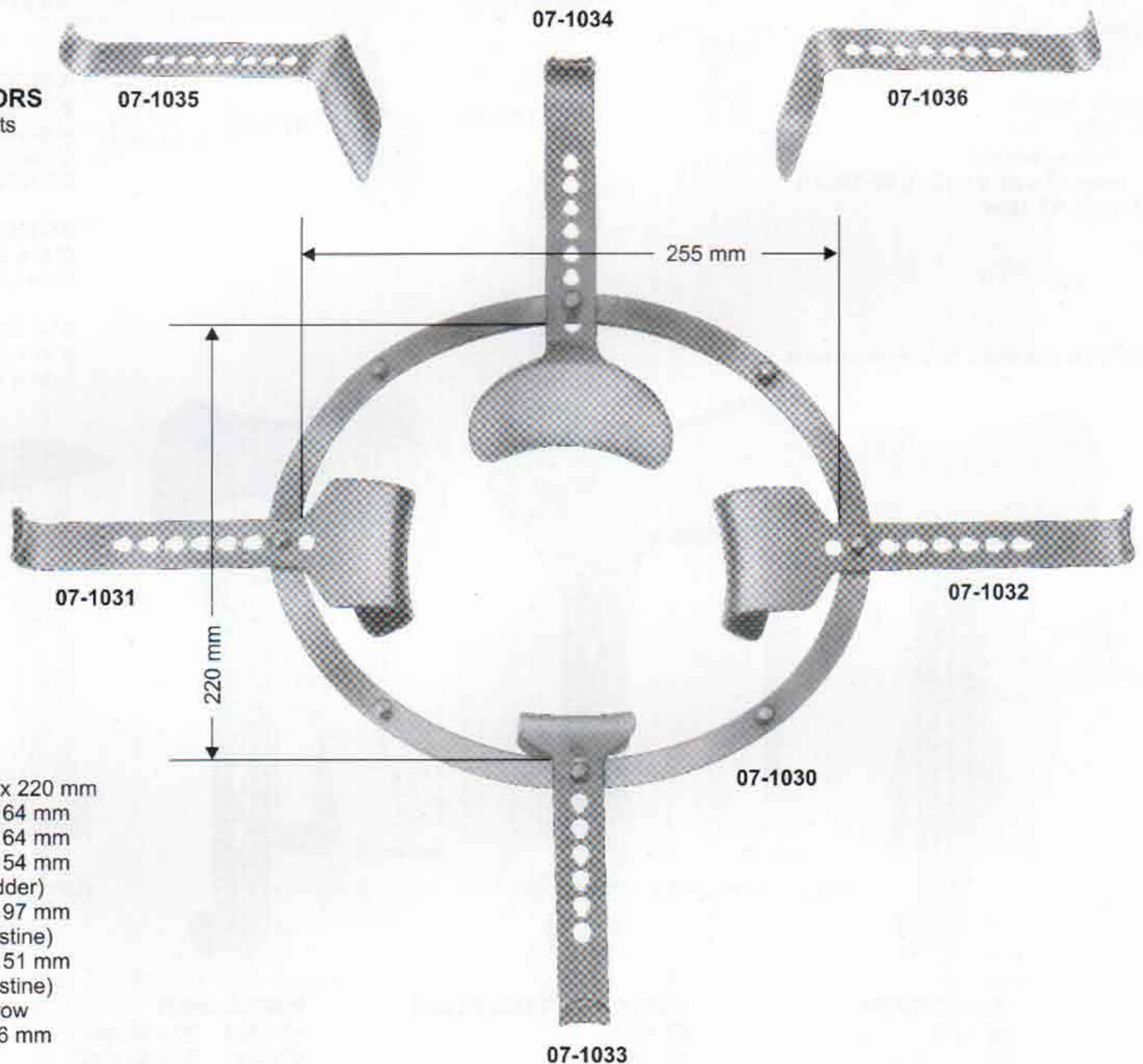

## SEMM

consisting of:

07-1030 1 frame 225 x 220 mm

07-1031 1 blade 46 x 64 mm

07-1032 1 blade 46 x 64 mm

07-1033 1 blade 53 x 54 mm  
(for bladder)

07-1034 1 blade 82 x 97 mm  
(for intestine)

07-1035 1 blade 98 x 51 mm  
(for intestine)

07-1036 1 blade, narrow  
107 x 36 mm



# RETRACTORS

Wundhaken  
Separadores

Ecarteurs  
Divaricatori

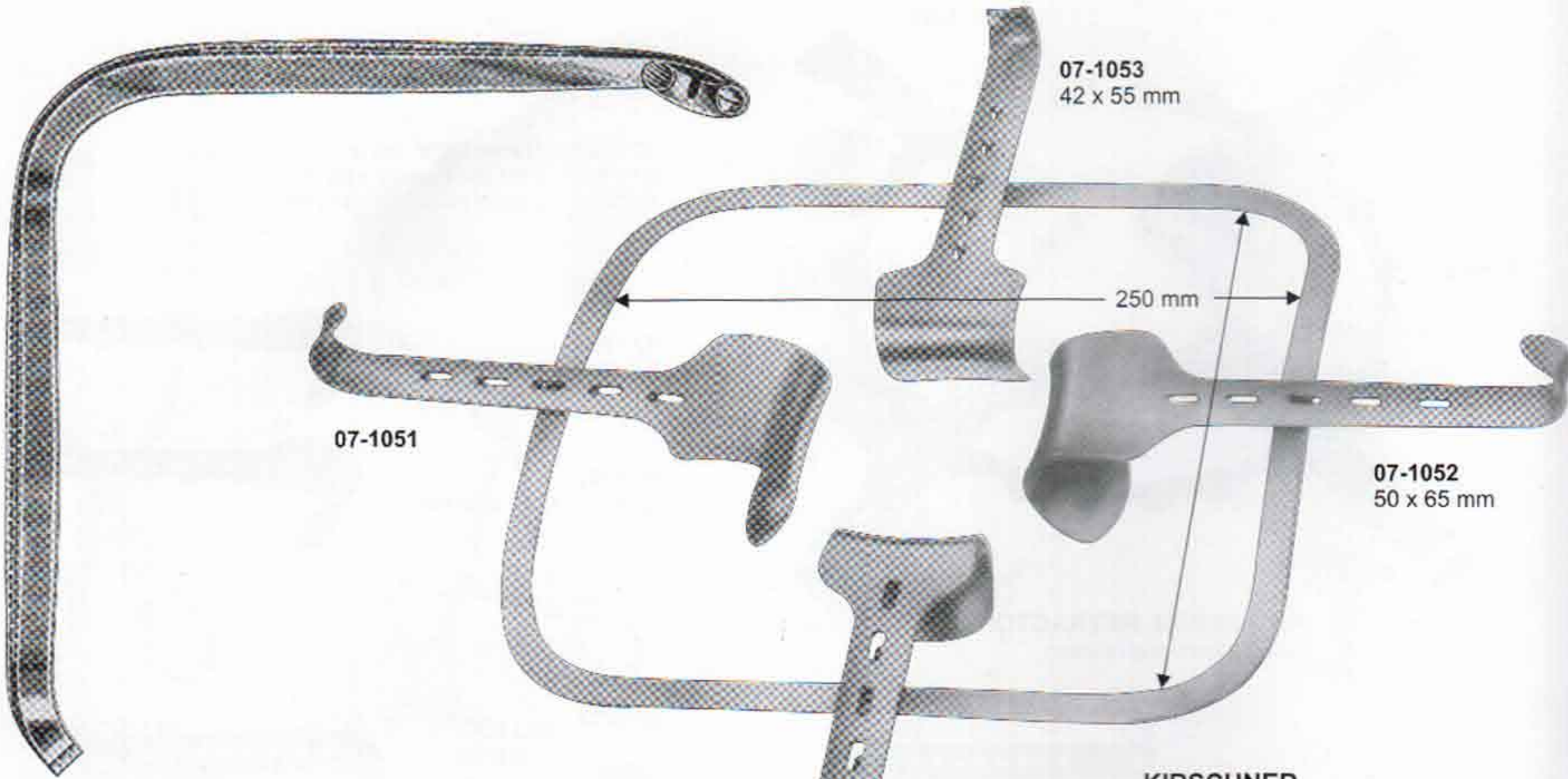

**KIRSCHNER**  
07-1050  
with folding frame &  
2 blades of each 07-1051, 07-1052 &  
07-1053, 07-1054

07-1054

**KIRSCHNER**  
07-1060  
with vaulted fixed frame &  
2 blades of each 07-1051, 07-1052 &  
07-1053, 07-1054

07-1061  
300 x 380 mm  
Frame only, over-sized

07-1062  
320 x 300 mm  
Frame only

Additional valves for corpulent persons



**KIRSCHNER**  
07-1070  
64 x 80 mm

**KIRSCHNER-BALFOUR**  
07-1080  
80 x 82 mm

**KIRSCHNER**  
07-1090 90 x 69 mm  
07-1091 92 x 95 mm  
07-1092 78 x 58 mm

**KIRSCHNER**  
07-1100 108 x 42 mm  
07-1101 91 x 55 mm  
07-1102 121 x 55 mm



# THORACIC/CARDIOVASCULAR

Thorax-cardiovasculaire  
Thorax-cardiovasculaire

Torace-cardiovascolare  
Torax-cardiovascular



**08-101**  
Plastic Probe tip



**08-102**  
3 mm Ø  
Olive



**08-103**  
6 mm Ø  
Olive



**08-104**  
9 mm Ø  
Olive



**08-105**  
12 mm Ø  
Olive



**08-106**  
15 mm Ø  
Olive

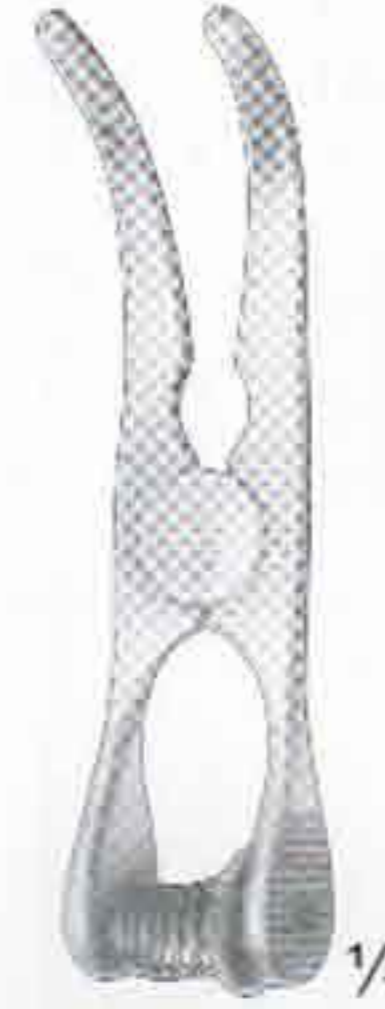

**08-120 -  
08-121**



**08-130 -  
08-131**

## COOLEY Atraumatic Bulldog Clamp

Cat.#	Jaw Length mm	Jaw	Length
08-120	20	Str.	5.0 cm, 2"
08-121	30	Str.	5.5 cm, 2 5/8"
08-130	47	Str.	9.5 cm, 3 3/8"
08-131	60	Str.	12.5 cm, 5"



**NABATOFF**  
**08-100**  
varicose vein probe  
set complete

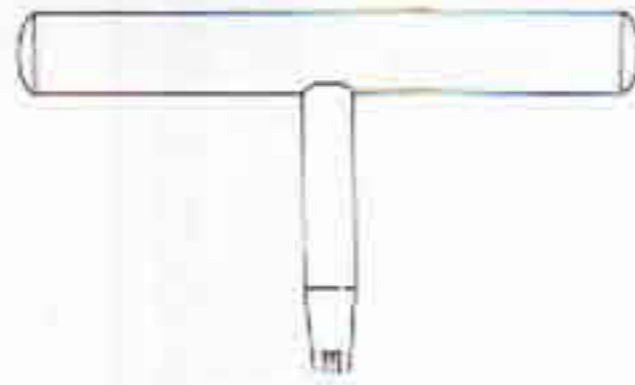

**08-107**  
Handle, T-form



**TRACTION CABLE**  
**08-108**  
90 cm, 36"



**08-140**  
5.0 cm, 2"  
Jaw Length 27 mm  
Straight



**08-141**  
5.0 cm, 2"  
Jaw Length 27 mm  
Curved

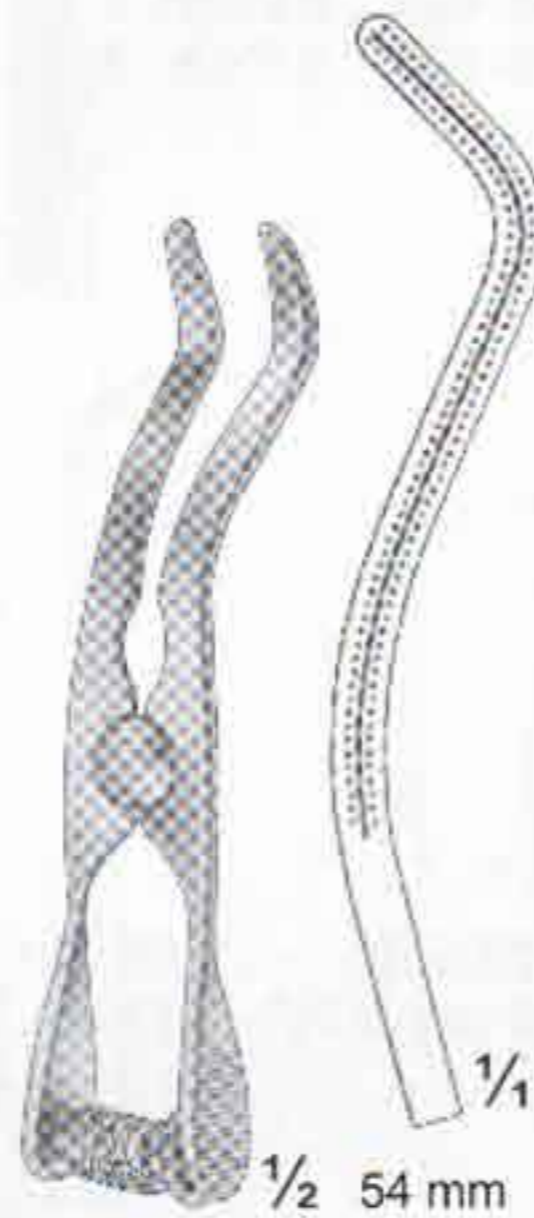

**08-150**  
10 cm, 4"  
Jaw Length 54 mm  
S-Ship

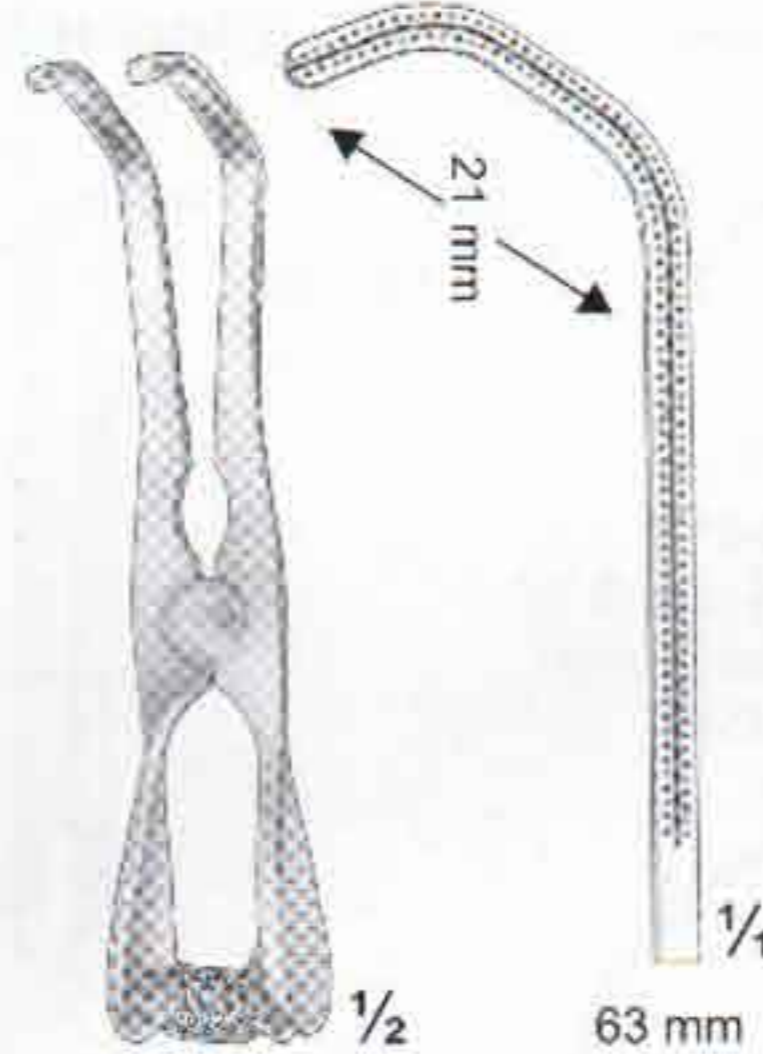

**08-151**  
10 cm, 4"  
Jaw Length 63 mm  
Multi

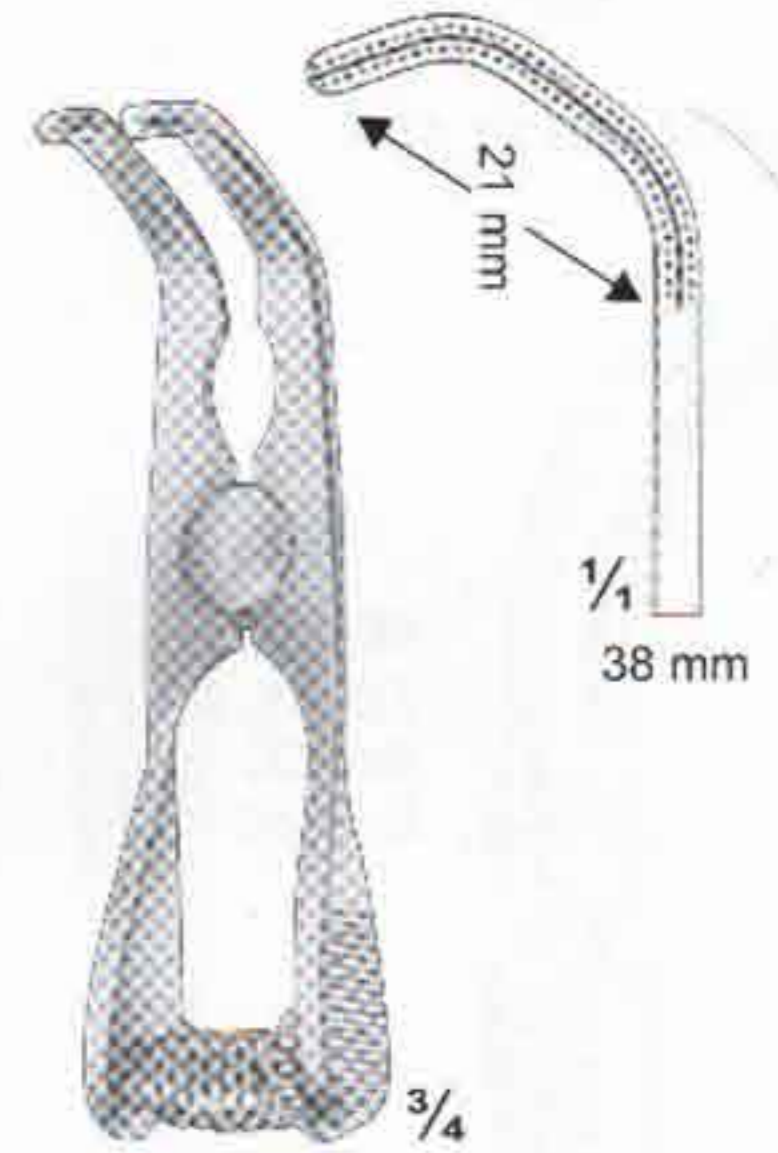

**08-152**  
7 cm, 2 3/4"  
Jaw Length 38 mm  
Multi

## DE BAKEY ATRAUMATIC MIN

## DE BAKEY ATRAUMATIC MIN



# THORACIC/CARDIOVASCULAR

Thorax-cardiovasculaire  
Thorax-cardiovasculair

Torace-cardiovascolare  
Torax-cardiovascular



**DIEFFENBACH**

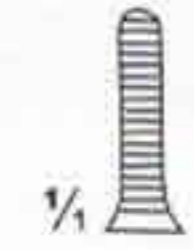

**08-160**  
3.8 cm, 1 1/2"



**08-161**  
3.8 cm, 1 1/2"



**08-162**  
5.1 cm, 2"



**08-163**  
6 cm, 2 1/2"



**08-164**  
6 cm, 2 1/2"



**08-165**  
6 cm, 2 1/2"



**DIETRICH**



**08-170**  
4.9 cm, 2"  
Jaw 8 mm  
Straight



**08-171**  
5.3 cm, 2"  
Jaw 12 mm  
Straight



**08-172**  
5.9 cm, 2 1/2"  
Jaw 20 mm  
Straight



**08-173**  
4.3 cm, 1 3/4"  
Jaw 8 mm  
Curved

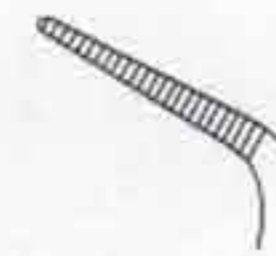

**08-174**  
4.5 cm, 1 3/4"  
Jaw 12 mm  
Curved

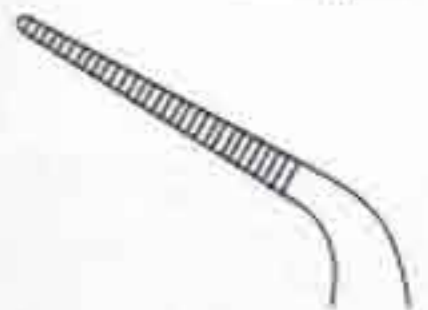

**08-175**  
5 cm, 2"  
Jaw 20 mm  
Curved



**BULLDOG CLAMP**

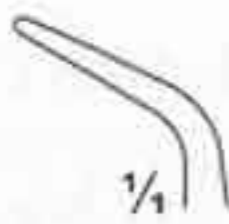

**08-180**  
4.3 cm, 1 3/4"  
Jaw 13 mm  
Curved



**08-181**  
4.9 cm, 2"  
Jaw 18 mm  
Curved

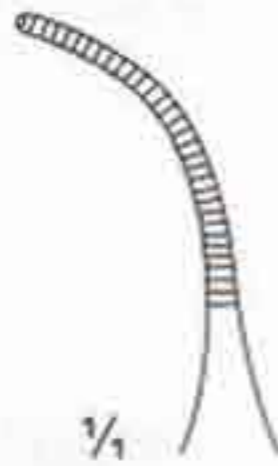

**08-182**  
5.4 cm, 2 1/4"  
Jaw 20 mm  
Curved



**JOHNS-HOPKINS**

**08-190** 3.8 cm, 1 1/2"  
**08-191** 5.0 cm, 2"  
**08-192** 5.5 cm, 2 1/8"  
**08-193** 6.0 cm, 2 1/2"  
**08-194** 7.0 cm, 2 3/4"  
**08-195** 8.0 cm, 3 1/8"  
**08-196** 8.5 cm, 3 1/2"



**DEBAKEY**



**08-200**  
8 cm, 3 1/4"  
Jaw 20 mm  
Straight



**08-201**  
9 cm, 3 1/2"  
Jaw 30 mm  
Straight



**08-202**  
10.5 cm, 4"  
Jaw 45 mm  
Straight



**08-203**  
12.5 cm  
Jaw 68 mm  
Straight



**DEBAKEY**



**08-210**  
7.5 cm, 3"  
Jaw 20 mm  
Curved



**08-211**  
8.5 cm, 3 1/2"  
Jaw 30 mm  
Curved

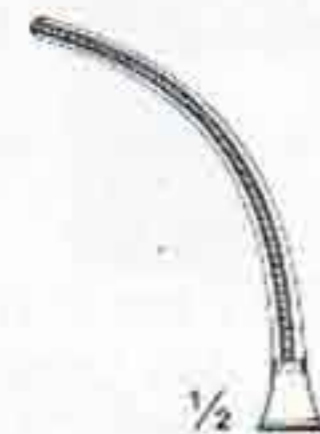

**08-212**  
9.5 cm, 3 3/4"  
Jaw 45 mm  
Curved



**08-213**  
11.5 cm, 4 3/4"  
Jaw 68 mm  
Curved



**GREGORY-SOFT**



**08-220**  
9 cm, 3 1/2"



**08-221**  
11 cm, 4 1/2"

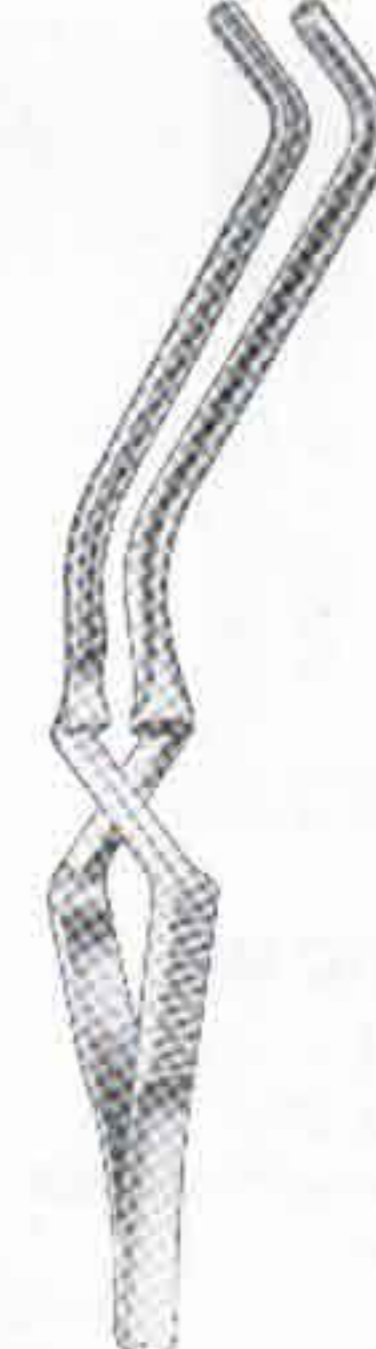

**GREGORY-SOFT**  
11 cm, 4 1/2"



**08-230**  
left



**08-231**  
right



# THORACIC/CARDIOVASCULAR

Thorax-cardiovasculaire  
Thorax-cardiovasculair

Torace-cardiovascolare  
Torax-cardiovascular

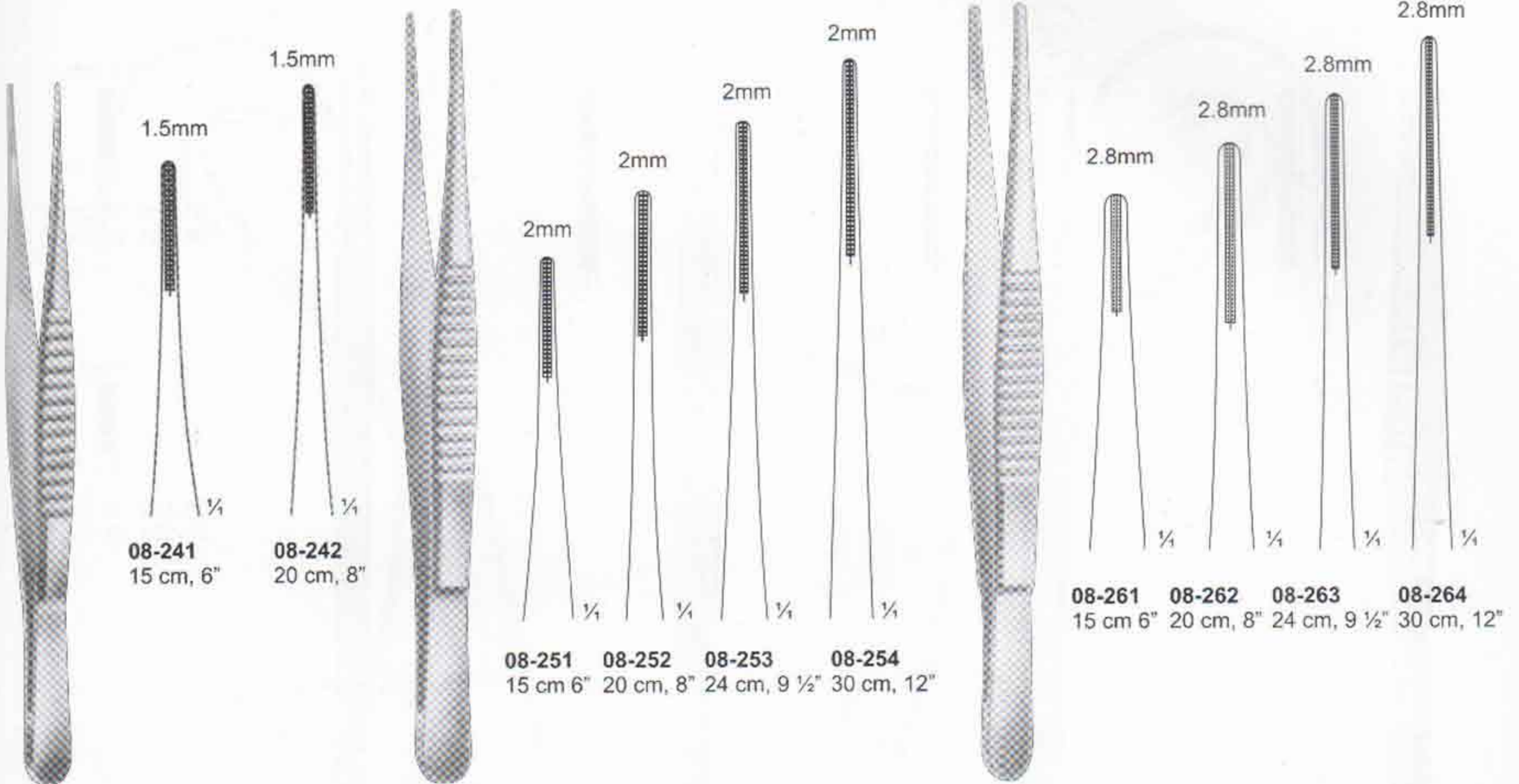

DE BAKEY  
08-240

DE BAKEY  
08-250

DE BAKEY  
08-260

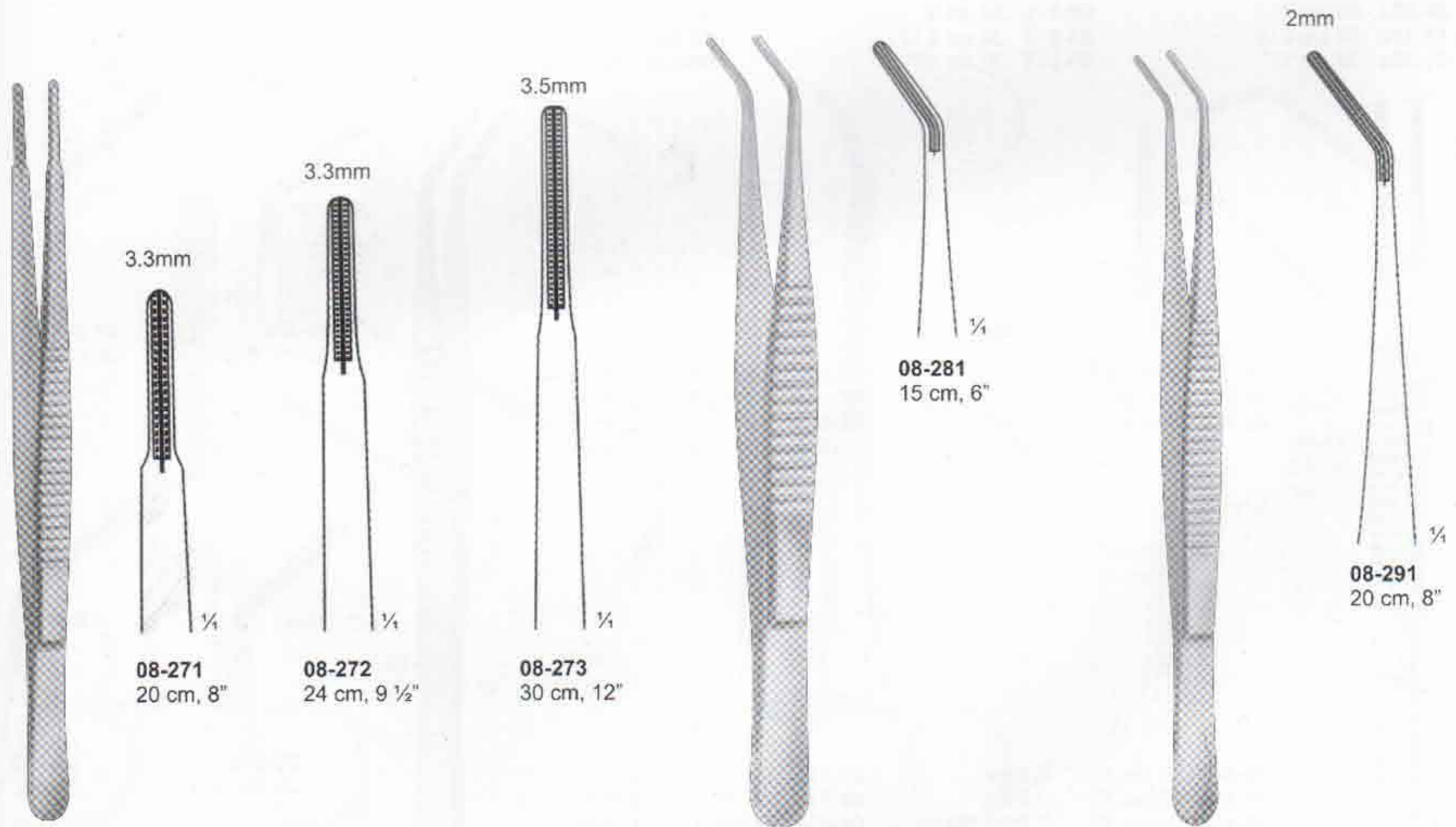

DE BAKEY  
08-270

DE BAKEY  
08-280

DE BAKEY  
08-290



# THORACIC/CARDIOVASCULAR

Thorax-cardiovasculaire  
Thorax-cardiovasculair

Torace-cardiovascolare  
Torax-cardiovascular



2.7 mm



3.5 mm

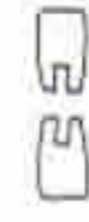

2 mm

1.2 mm



08-330 18 cm, 7"  
08-301 21 cm, 8 1/4"

2 mm



08-332 18 cm, 7"  
08-303 21 cm, 8 1/4"

## DEBAKEY

08-300 15 cm 6"  
08-301 20 cm 8"  
08-302 24 cm 9 1/2"  
08-303 30 cm 12"

## DEBAKEY

08-310 15 cm 6"  
08-311 20 cm 8"  
08-312 24 cm 9 1/2"  
08-313 30 cm 12"

## COOLEY

08-320 15 cm 6"  
08-321 20 cm 8"  
08-322 24 cm 9 1/2"  
08-323 30 cm 12"

## DE BAKEY



08-340 16 cm, 6 1/2" 1.5 mm  
08-341 20 cm, 8" 1.5 mm  
08-342 24 cm, 9 1/2" 1.5 mm



08-343 16 cm, 6 1/2" 2.0mm  
08-344 20 cm, 8" 2.0mm  
08-345 24 cm, 9 1/2" 2.0mm  
08-346 30.5 cm, 12" 2.0mm

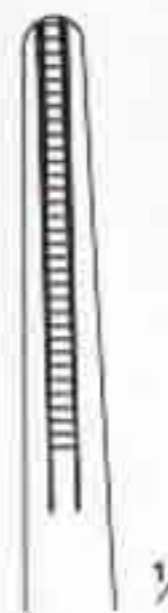

08-347 16 cm, 6 1/2" 2.7mm  
08-348 20 cm, 8" 2.7mm  
08-349 20 cm, 8" 2.7mm Heavy  
08-350 24 cm, 9 1/2" 2.7mm  
08-351 30.5 cm, 12" 2.7mm

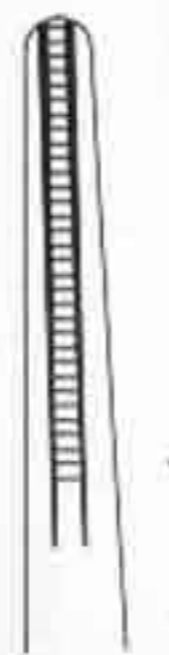

08-352 16 cm, 6 1/2" 3.5mm  
08-353 20 cm, 8" 3.5mm  
08-354 24 cm, 9 1/2" 3.5mm  
08-355 30.5 cm, 12" 3.5mm

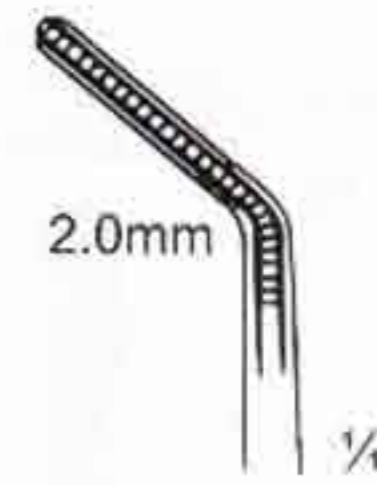

08-370 16 cm, 6 1/2"

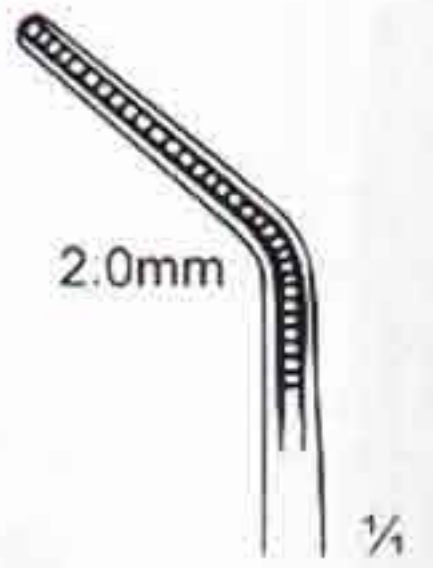

08-371 20 cm, 8"

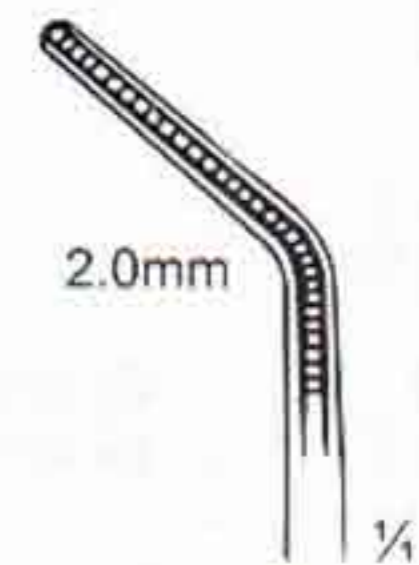

08-372 24 cm, 9 1/2"

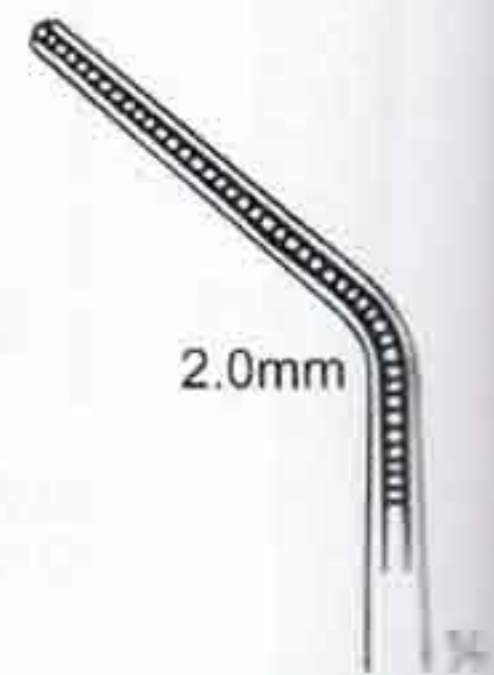

08-373 30 cm, 12"

## DE BAKEY

## DE BAKEY



# THORACIC/CARDIOVASCULAR

Thorax-cardiovasculaire  
Thorax-cardiovasculair

Torace-cardiovascolare  
Torax-cardiovascular



**WEBER**  
**08-380**  
26 cm, 10 1/4"  
left



**WEBER**  
**08-390**  
26 cm, 10 1/4"  
right

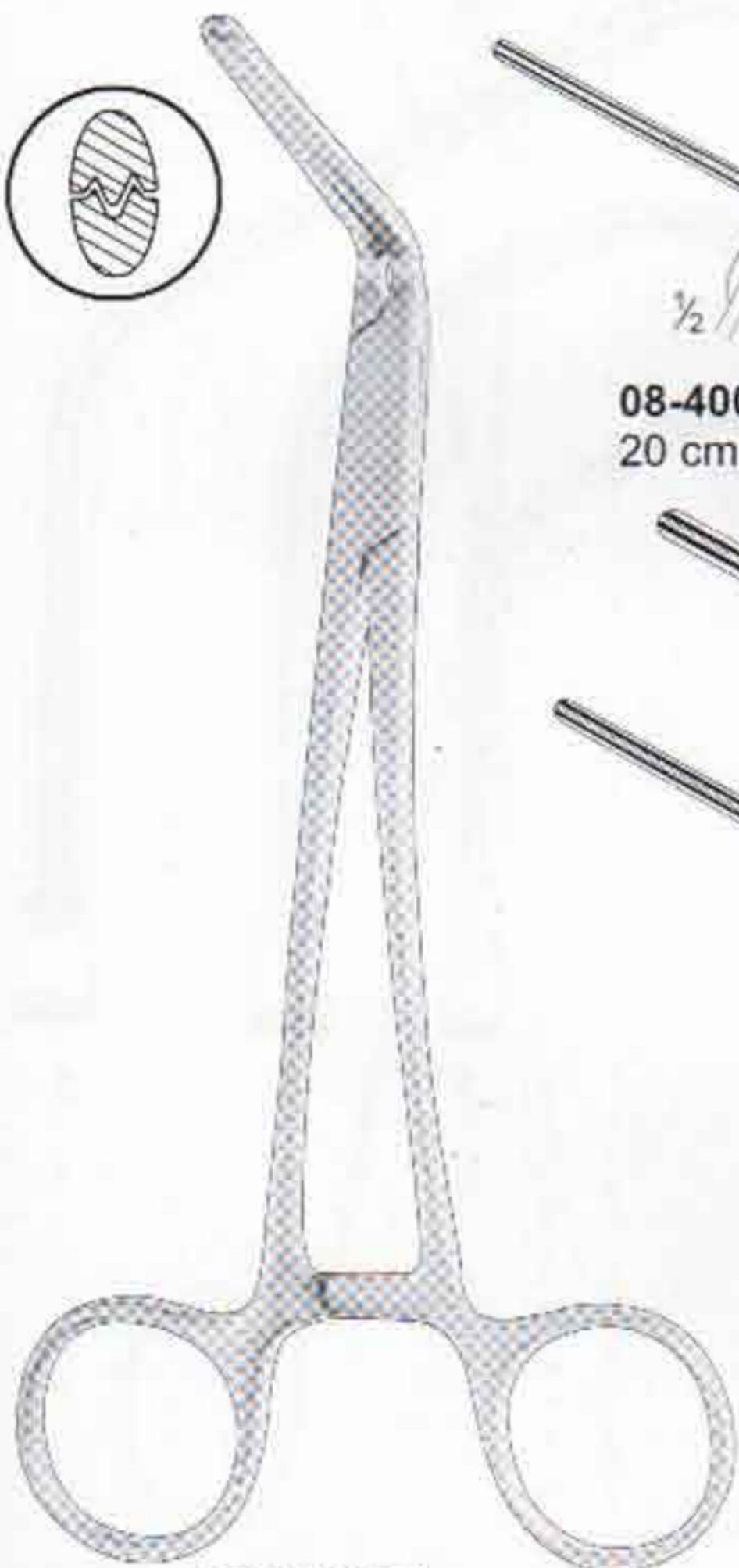

**DE BAKEY**  
Right Angled Jaws



**08-400**  
20 cm, 8"



**08-401**  
19 cm, 7 1/2"

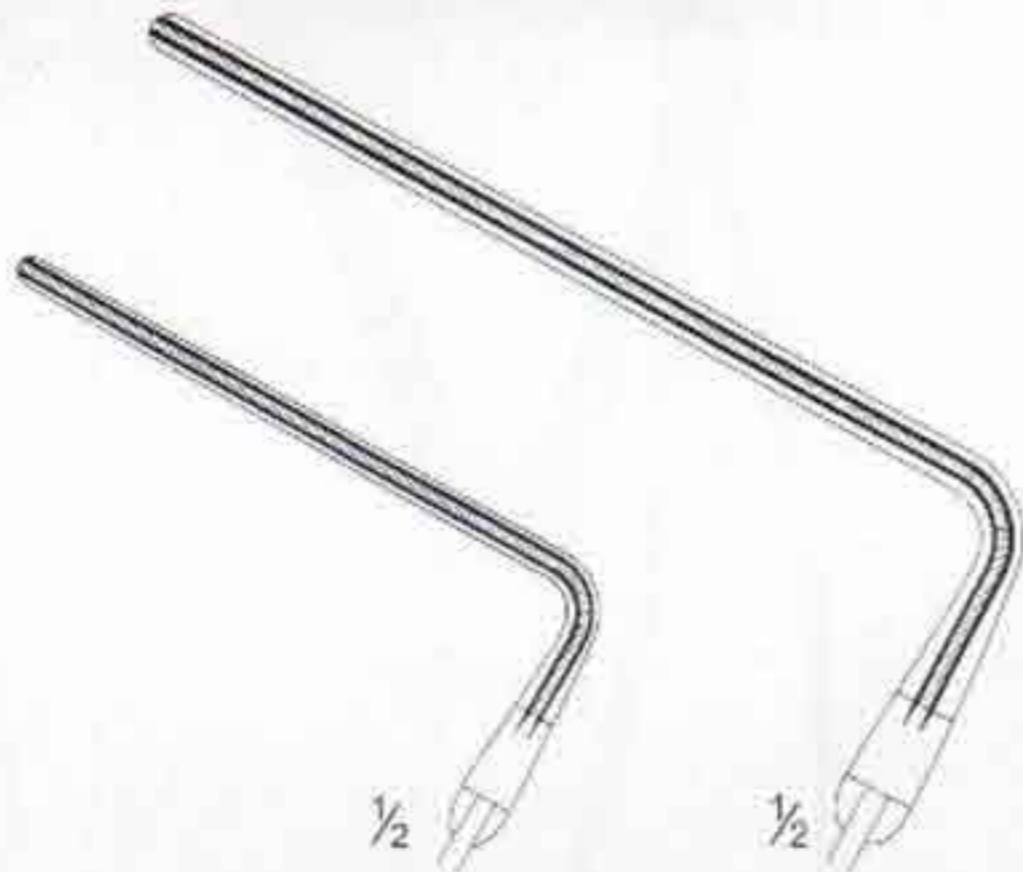

**08-402**  
22 cm, 8 3/4"



**08-403**  
27 cm, 10 3/4"



**DE BAKEY**



**08-410**  
19 cm,  
7 1/2"



**08-411**  
25 cm,  
10"



**08-412**  
25 cm,  
10"



**08-413**  
25 cm,  
10"



**08-414**  
27 cm,  
10 3/4"



# THORACIC/CARDIOVASCULAR

Thorax-cardiovasculaire  
Thorax-cardiovasculair

Torace-cardiovascolare  
Torax-cardiovascular

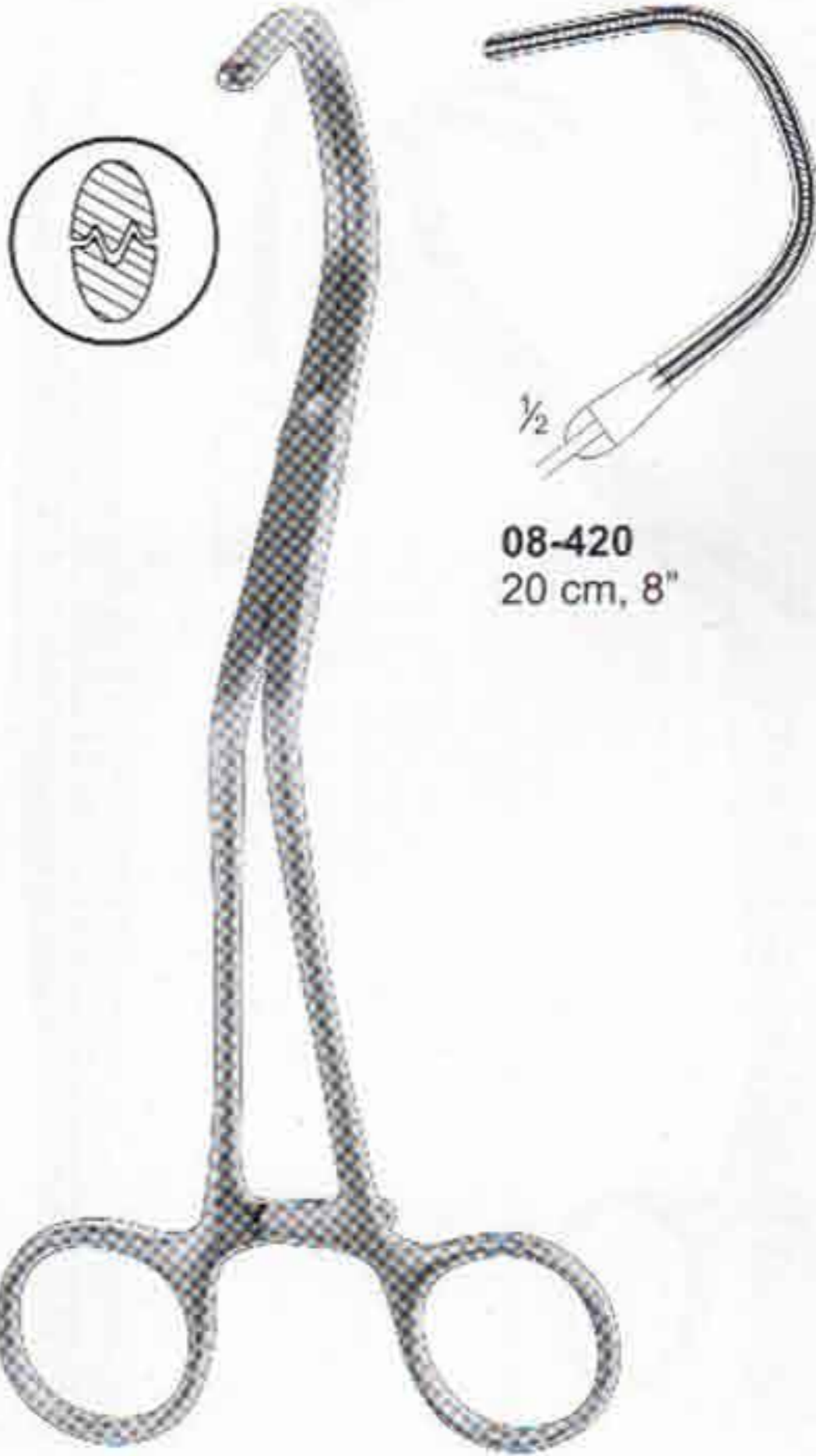

**08-420**  
20 cm, 8"

**KAY**



**08-430**  
16.5 cm, 6 1/2"

**SUBRAMANIAN**



**08-440**  
22.5 cm, 9"  
Jaw Length  
60 mm

**08-441**  
22.5 cm, 9"  
Jaw Length  
80 mm

**BRONCHUS FORCEPS**

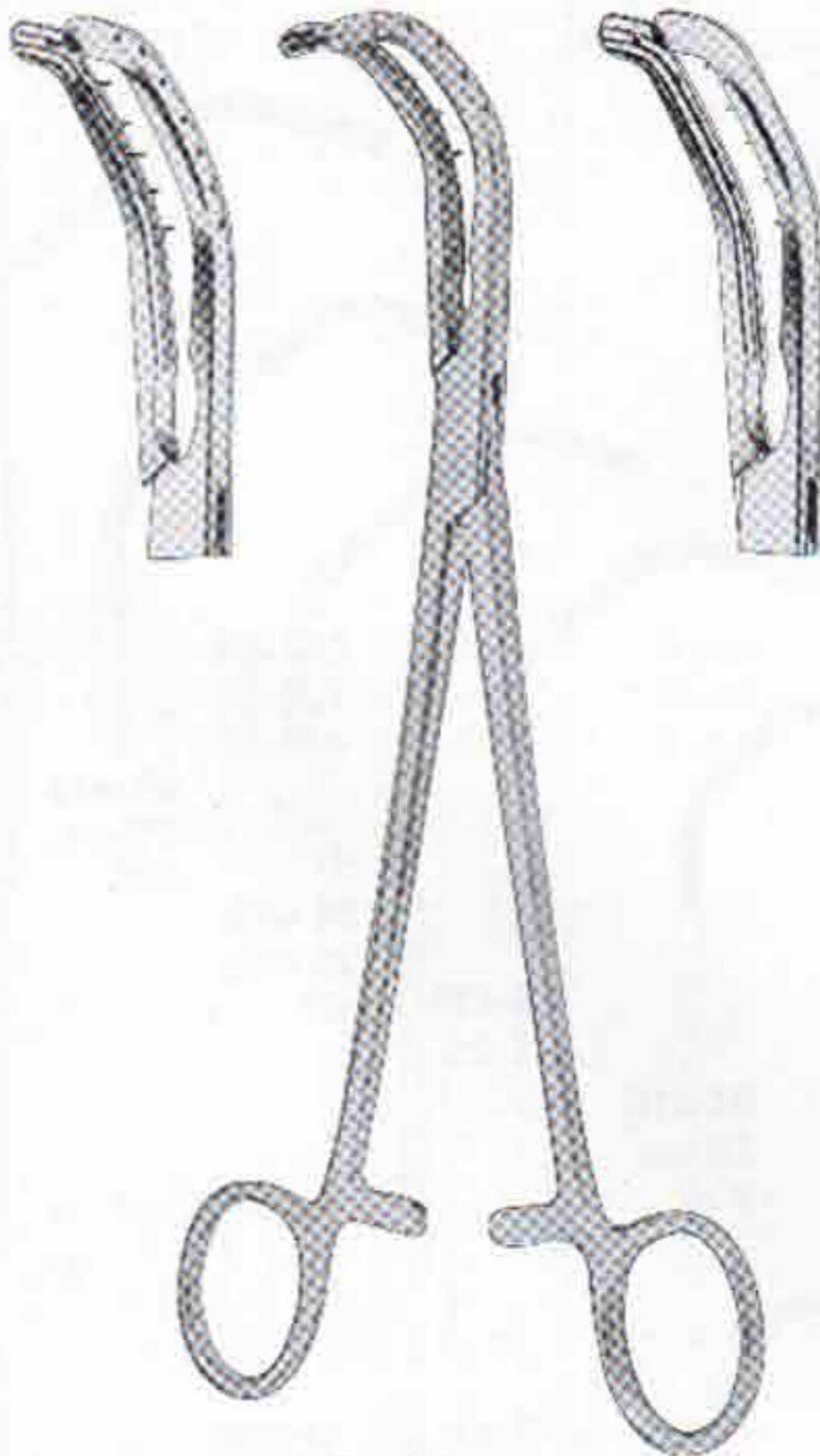

**SAROT**  
**08-450** 23cm  
**08-451** 23cm



**SATINSKY**  
**08-460 Fig 1** 15cm  
**08-461 Fig 2** 26cm  
**08-462 Fig 3** 26cm



# THORACIC/CARDIOVASCULAR

Thorax-cardiovasculaire  
Thorax-cardiovasculair

Torace-cardiovascolare  
Torax-cardiovascular

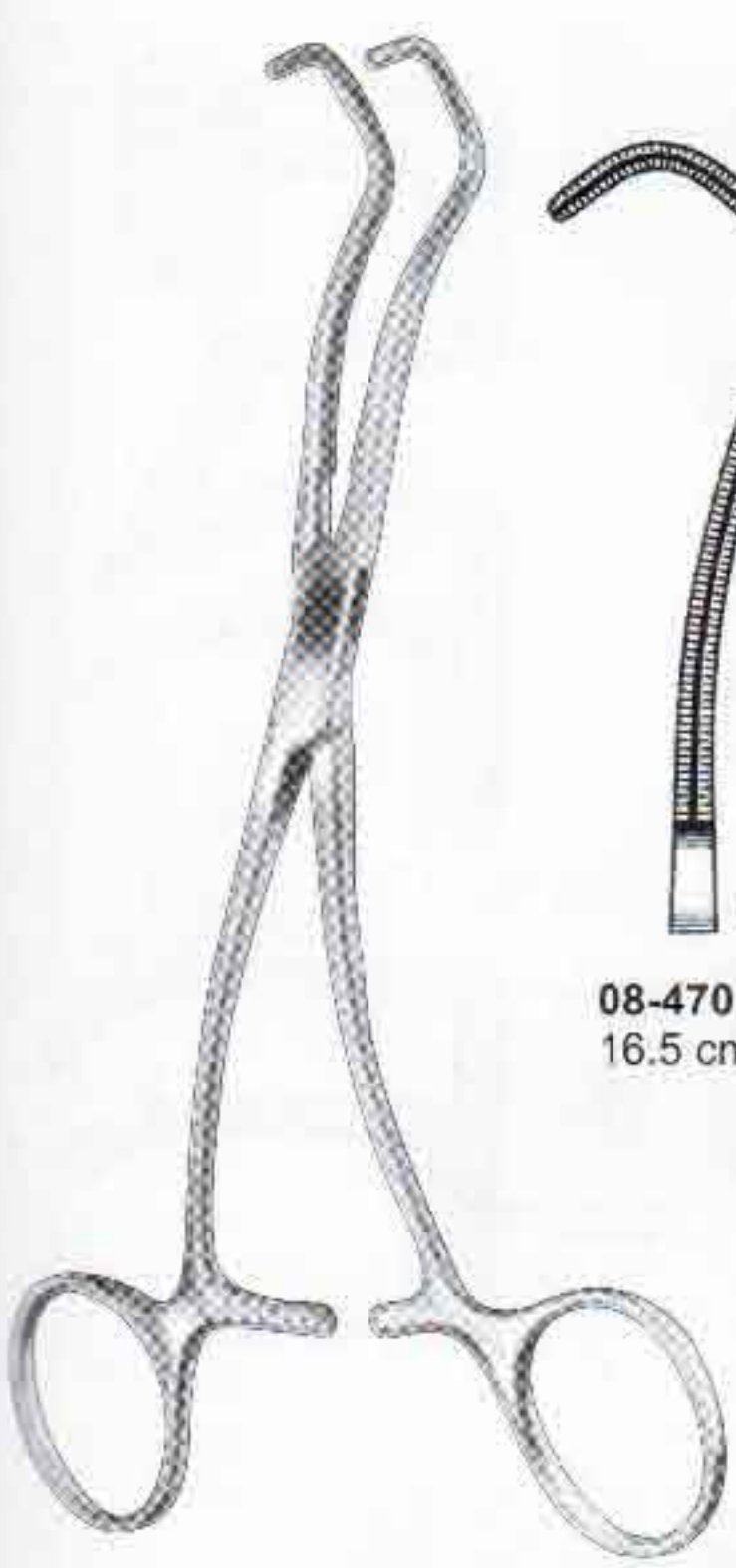

**DERRA**



**08-470**  
16.5 cm, 6 1/2"



**08-471**  
17 cm, 6 3/4"



**08-472**  
18 cm, 7"

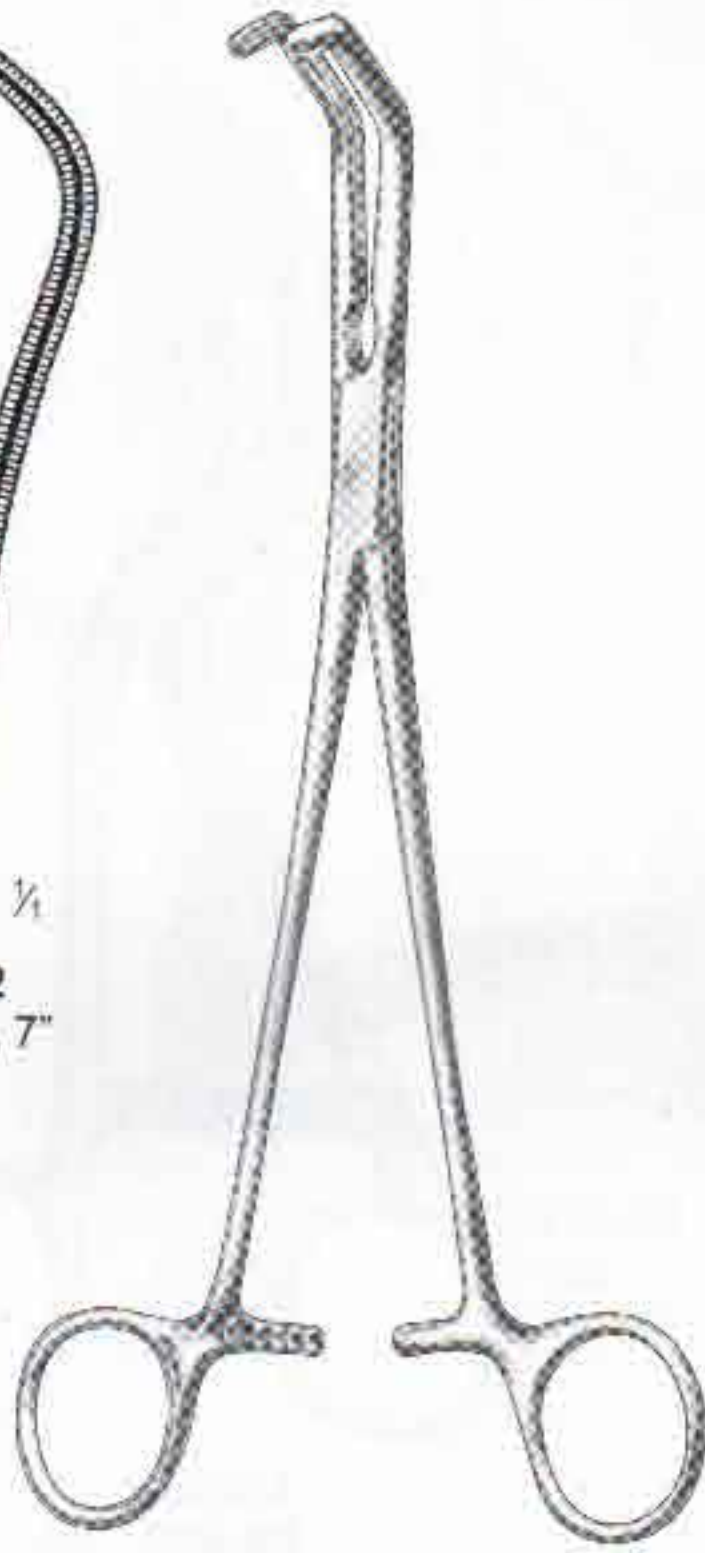

**PRICE-THOMAS**  
08-480 22cm

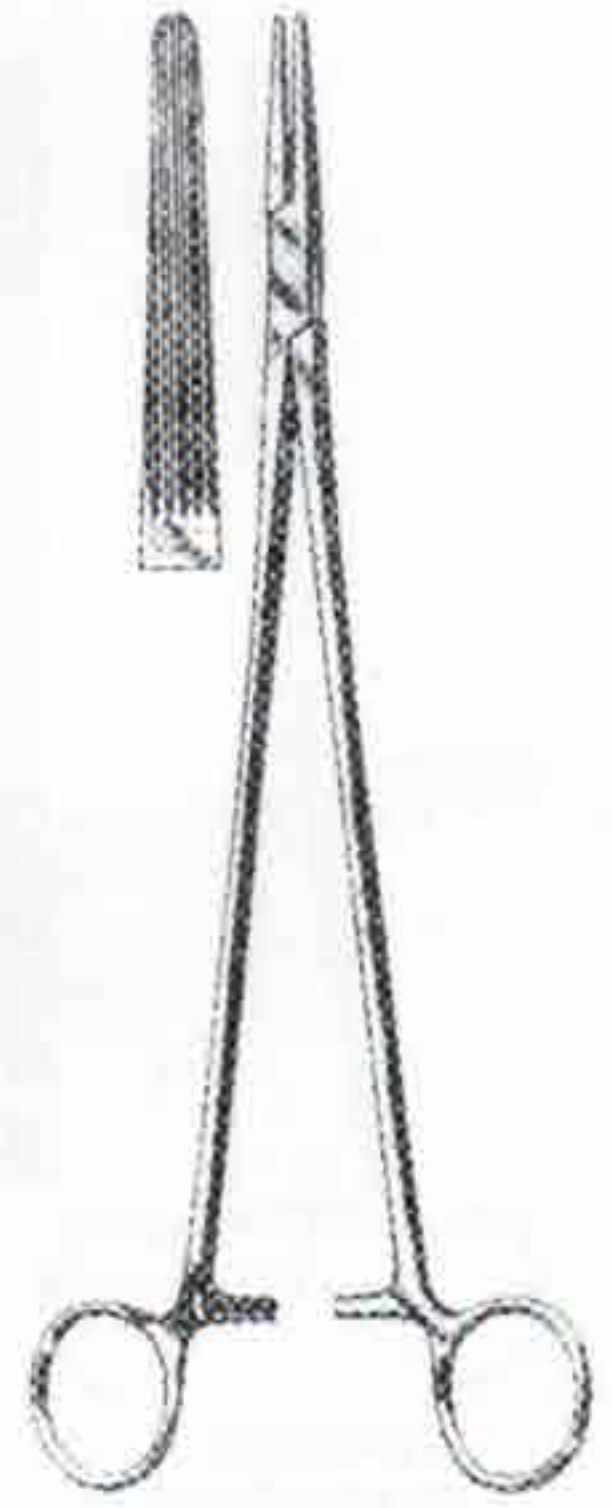

**WANGENSTEEN**  
08-490 28cm

**LUNG GRASPING**



**LOVELACE**  
08-500 20cm



**LOVELACE**  
08-510 20cm

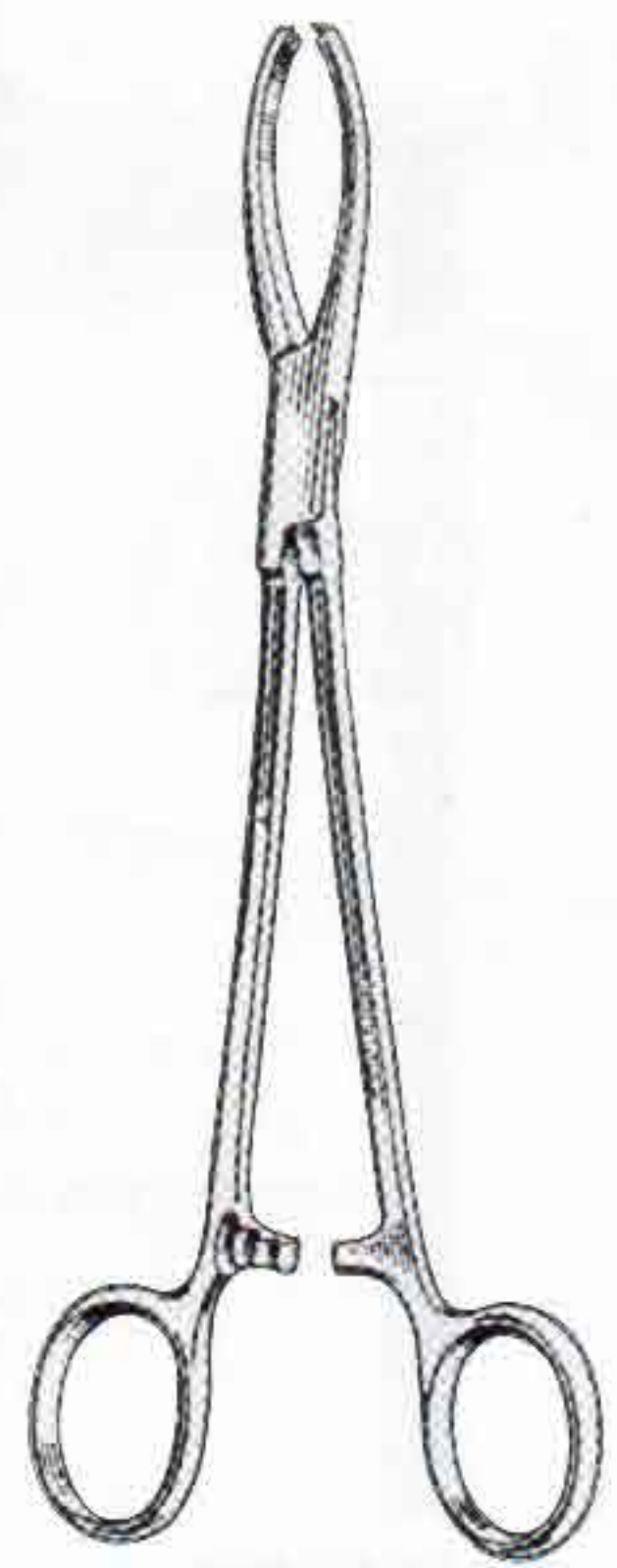

**HARRINGTON  
ROCHESTER**  
08-520 30cm



# THORACIC/CARDIOVASCULAR

Thorax-cardiovasculaire  
Thorax-cardiovasculair

Torace-cardiovascolare  
Torax-cardiovascular



**DAVIDSON**  
08-530 23cm

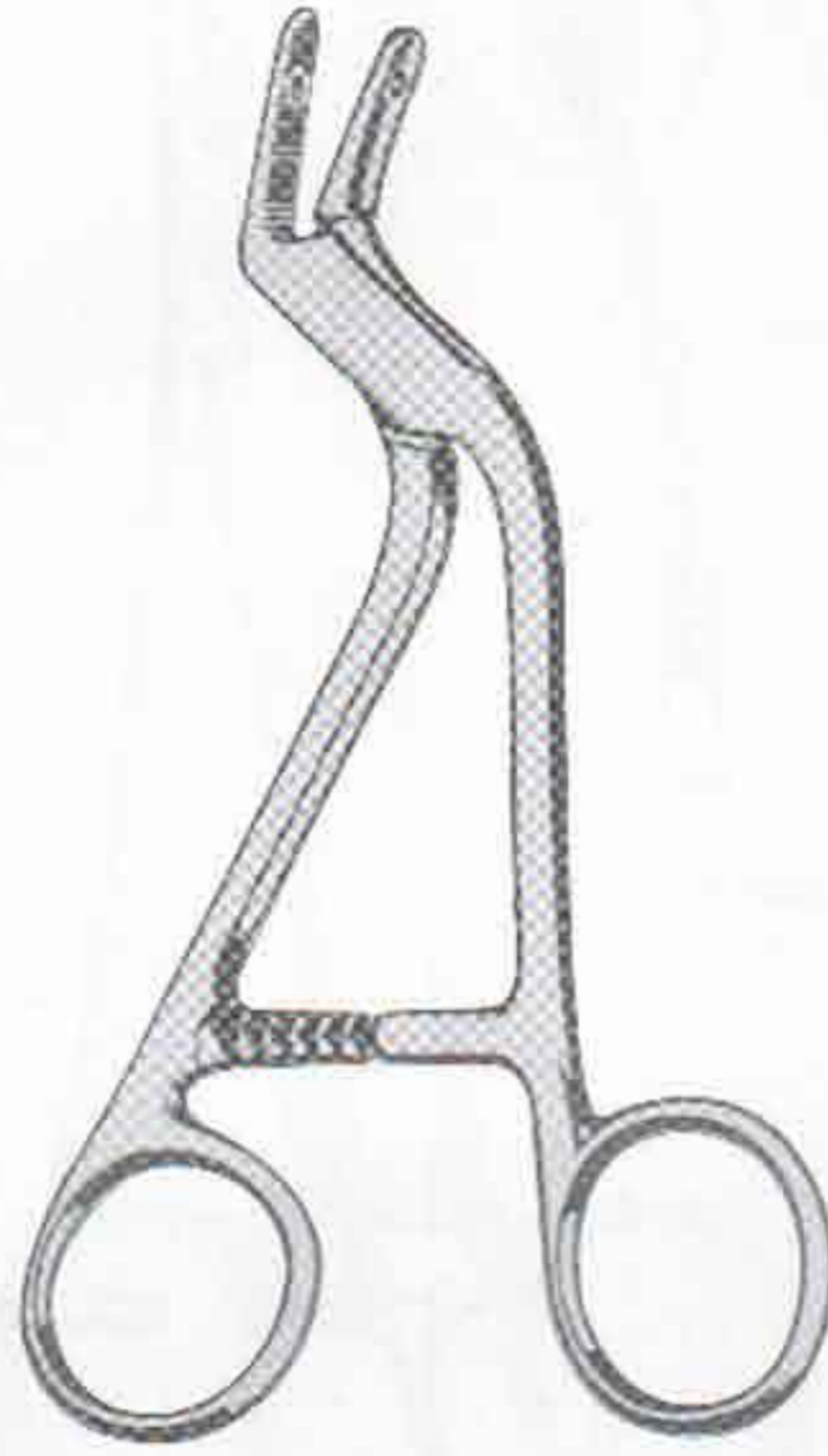

**ADSON**  
08-540 15cm



**BLALOCK**  
08-550 15cm  
08-551 20cm  
08-552 20cm

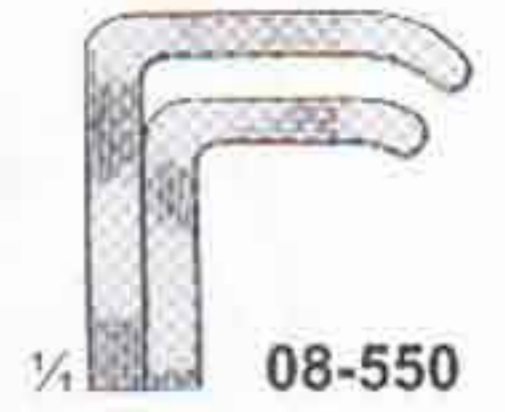

08-550



08-551

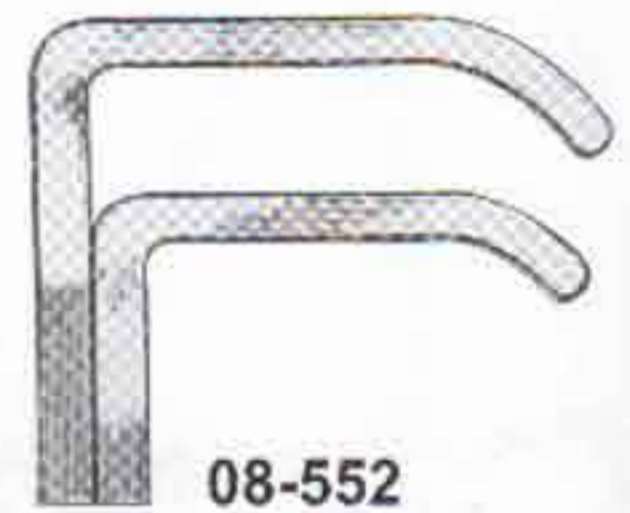

08-552



**BAILEY-GIBBON**  
08-560  
20 cm, 8"  
For Adult



08-561  
20 cm, 8"  
For children



**BAILEY-BABY**  
08-570  
15 cm, 6"



**SELLORS RIB CONTRACTOR**  
08-580  
20 cm, 8"



# RIB RETRACTORS

Rippensperrer  
Separador costal

Ecarteur de côtes  
Divaricatore costale

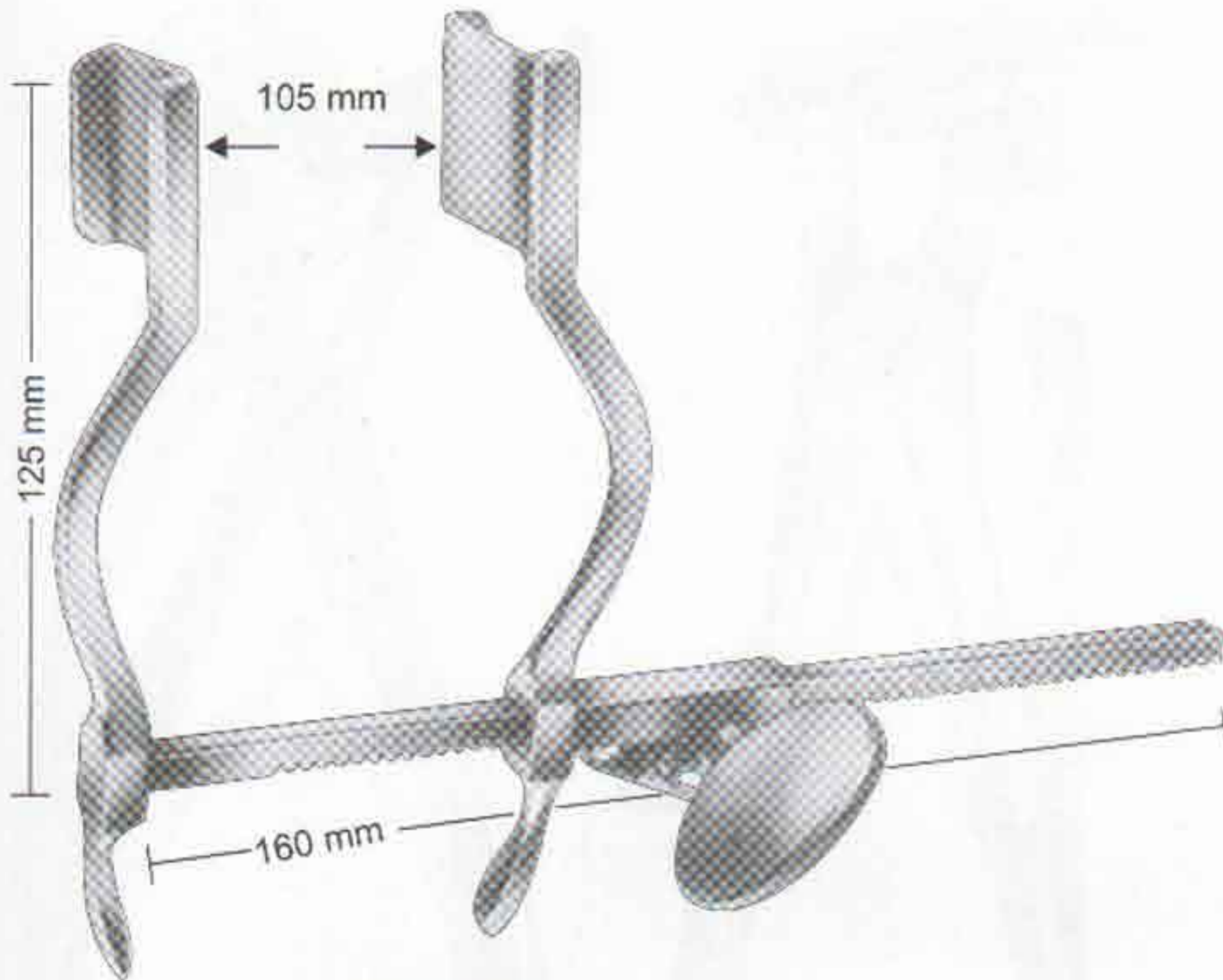

**HERTZLER**  
**08-590**  
blades 20 x 25 mm, spreading 105 mm

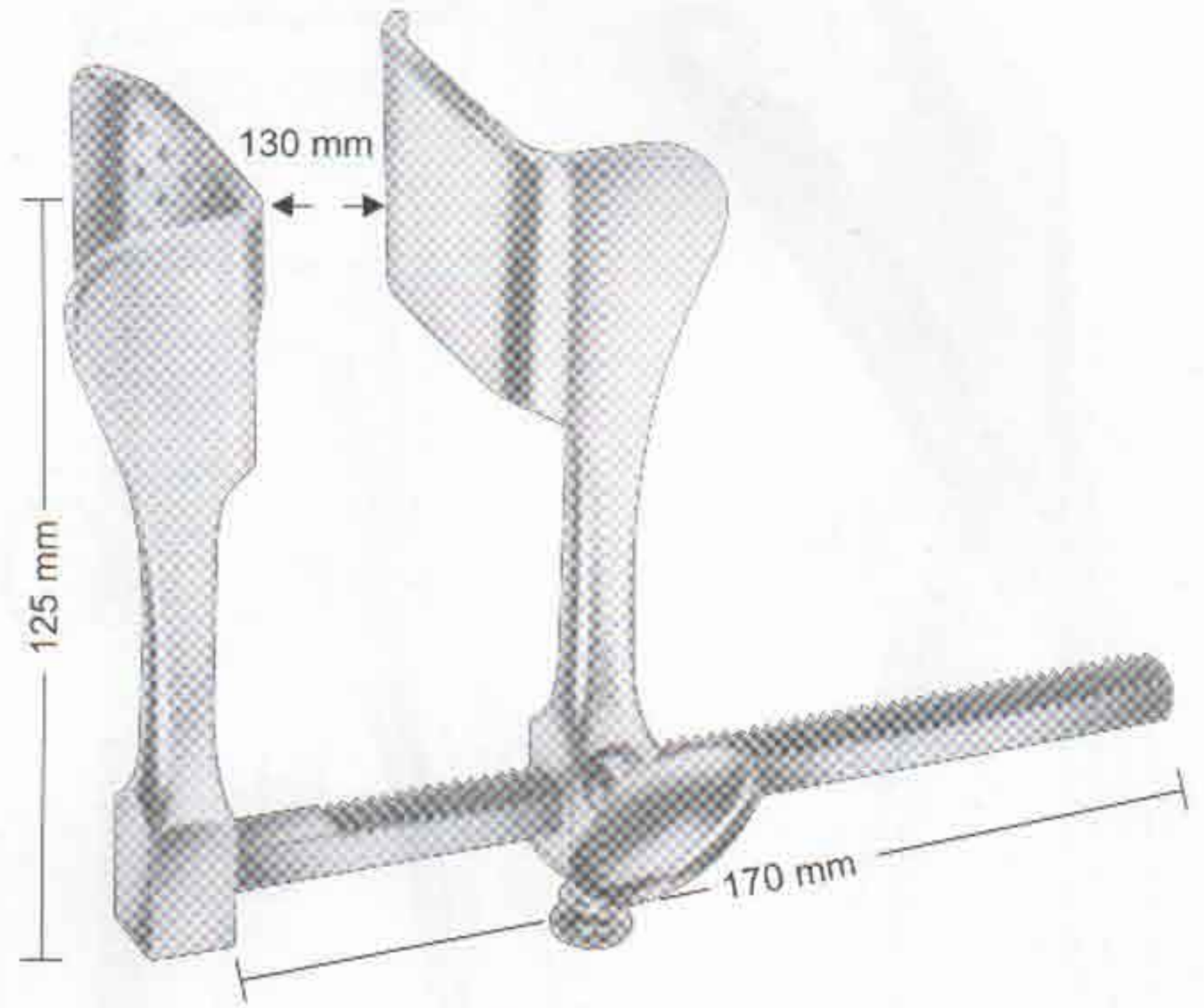

**TUFFIER**  
**08-600**  
blades 43 x 53 mm, spreading 130 mm



**FINOCCHIETTO,**  
**08-610**  
20 cm, 8"  
**08-611** 30 mm x 45 mm spreading 150 mm  
**08-612** 46 mm x 62 mm spreading 190 mm  
**08-613** 80 mm x 65 mm spreading 190 mm



**TUFFIER RIB RETRACTOR**  
**08-620**  
lateral blades 45 x 45 mm,  
spreading 160 mm



# RIB SHEARS, STERNUM CHISEL

Rippenscheren, Sternummeißel  
Costotomos, Cinceles

Costotomes, ciseau-Burin à sternum  
Costotomi, Scalpello per sterno

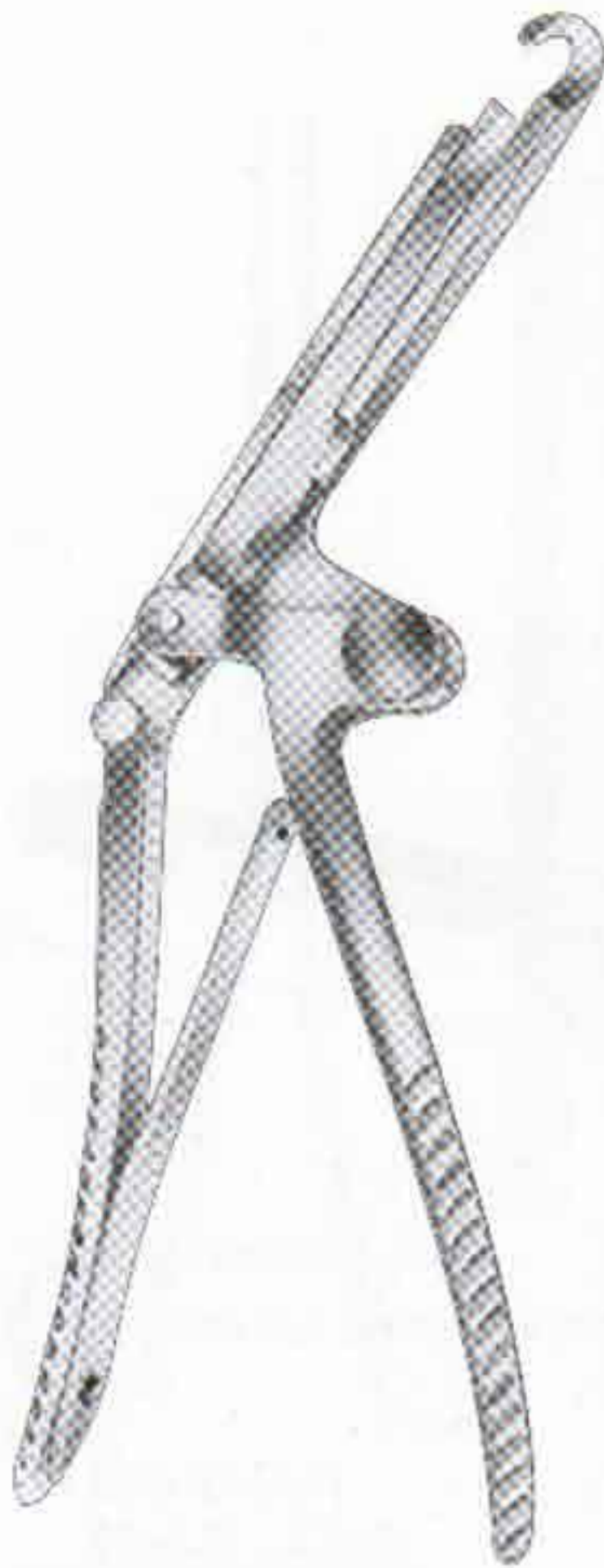

**SAUERBRUCH-FREY**  
08-630  
for the first rib  
37 cm, 14 1/2"

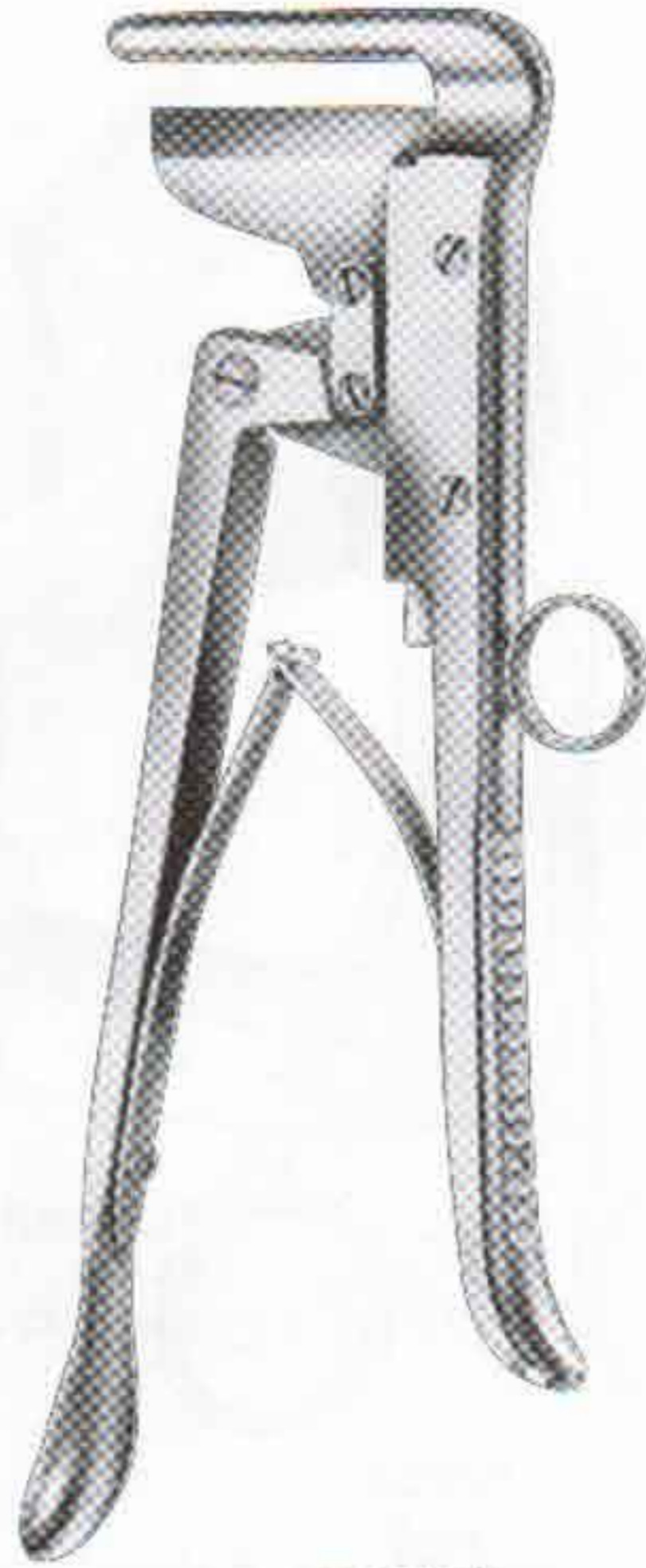

**SCHUMACHER**  
08-640  
sternum shears  
21 cm, 8 1/4"

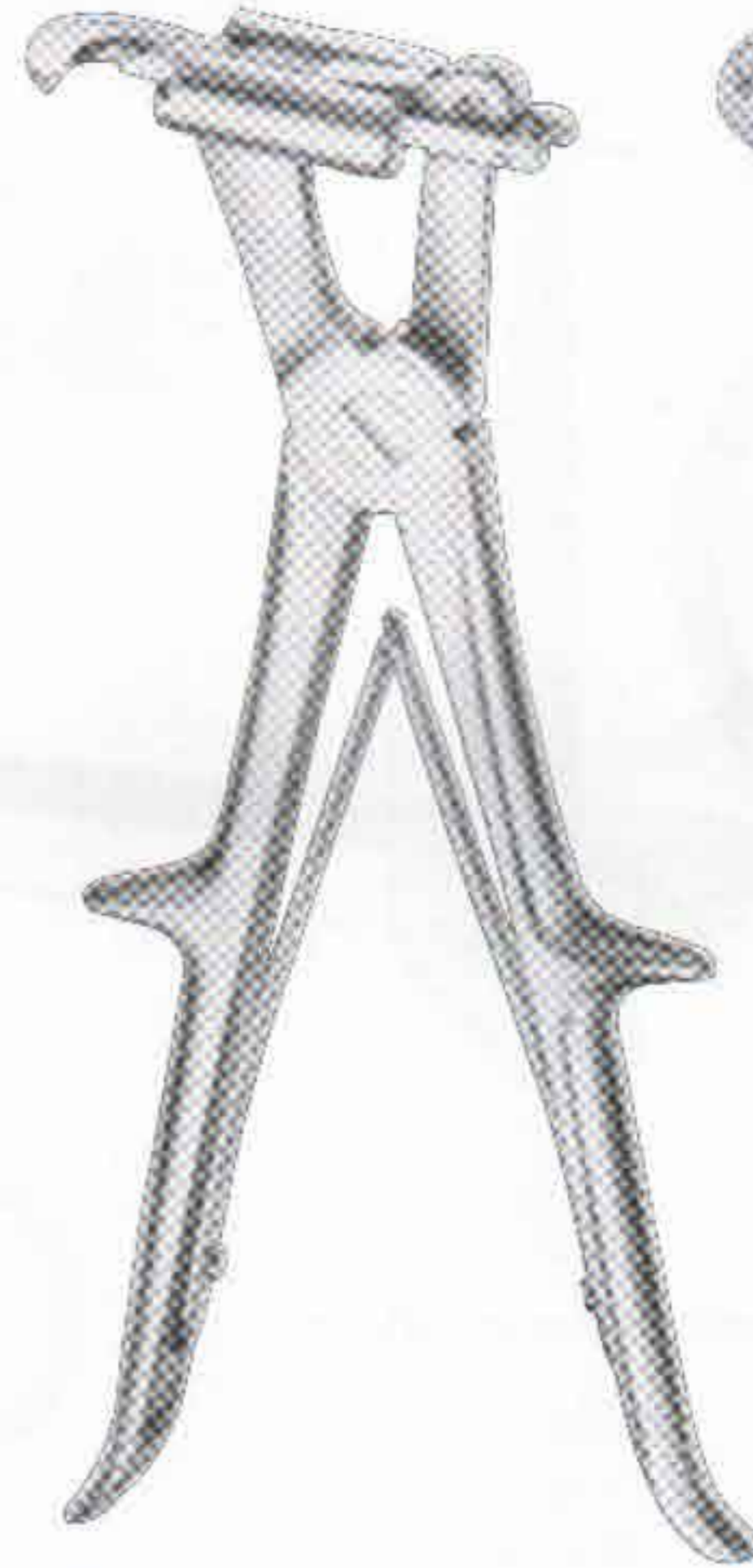

**SAUERBRUCH**  
08-650 24 cm, 9 1/2" For Children,  
08-651 27 cm, 10 3/4" For Adults,

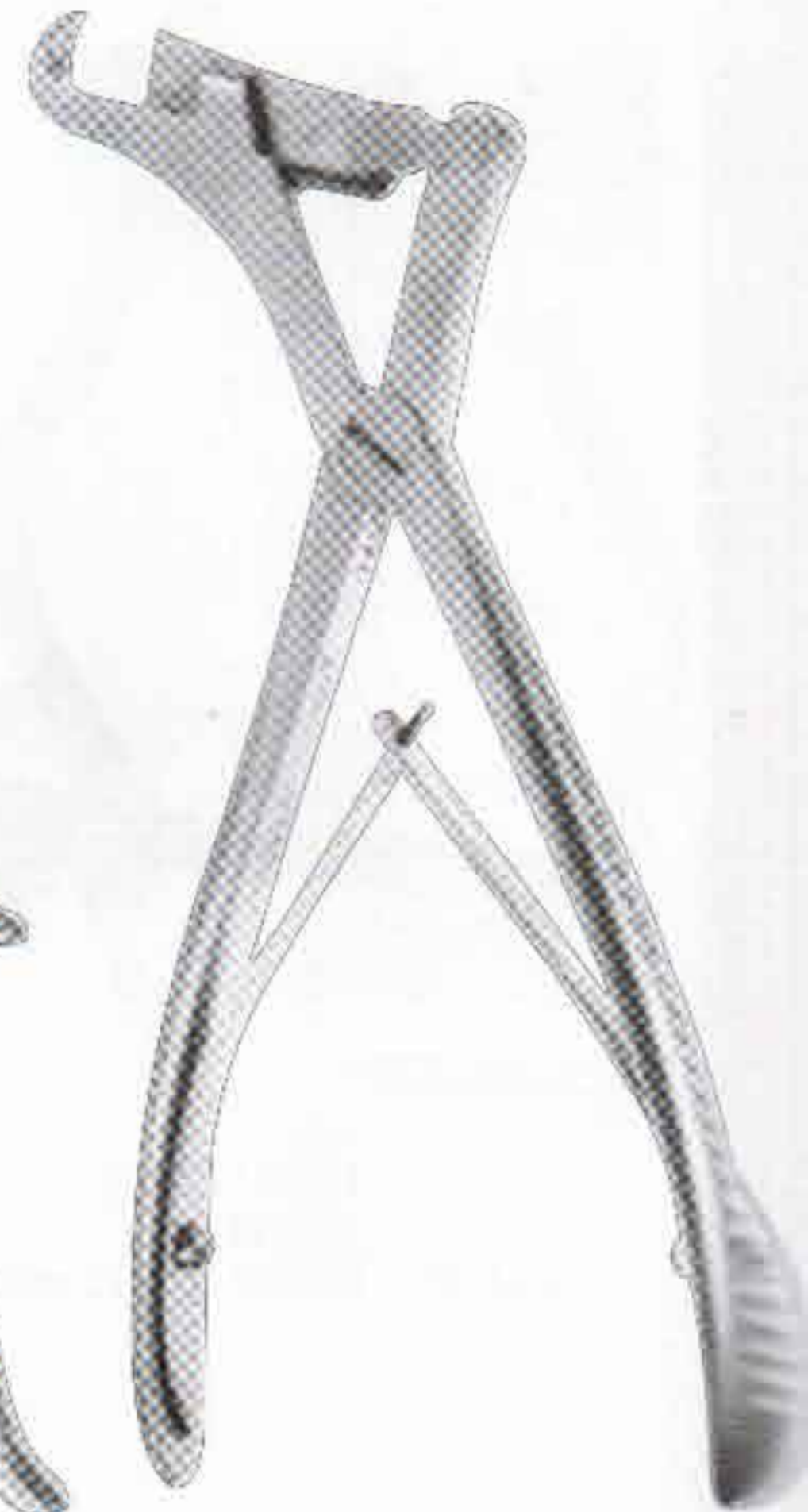

**SCHUARDT**  
08-660  
17 cm, 6 3/4"

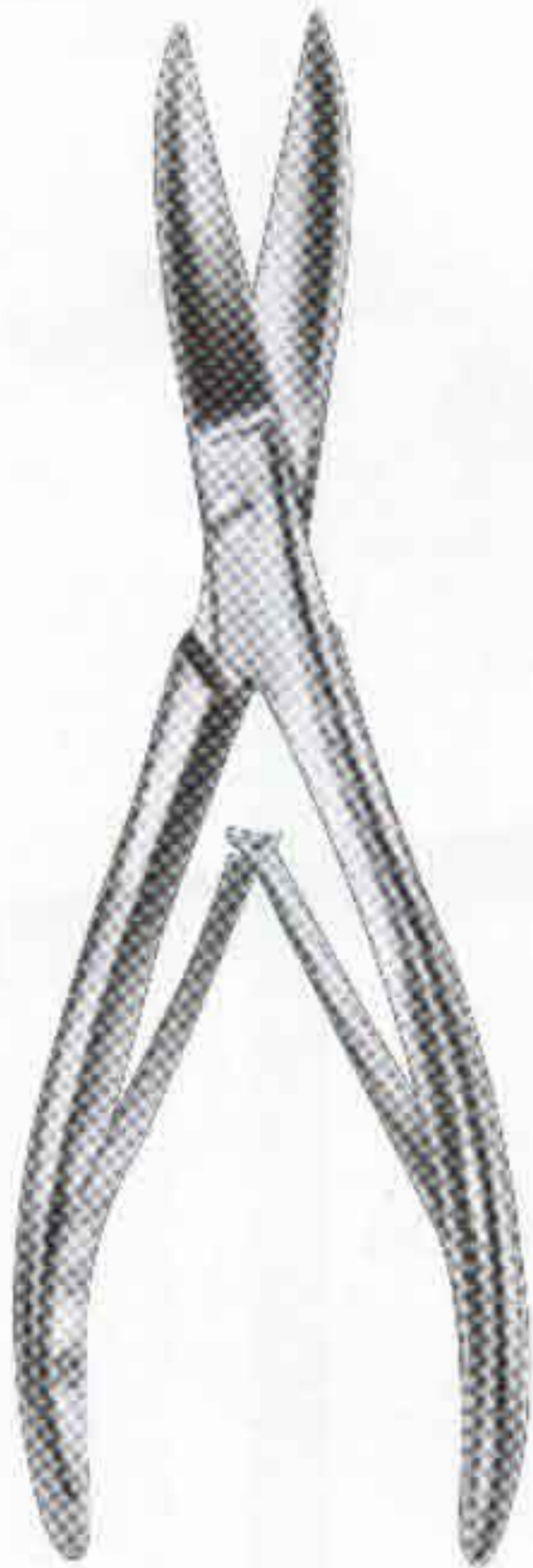

**BONE SHEAR**  
08-670  
23 cm, 9"



**08-680**  
19 cm, 7 1/4"



**RIB SHEAR**  
08-690  
23 cm, 9"



**GLUCK  
RIB SHEAR**  
08-700  
22 cm, 8 3/4"



**COLLIN**  
08-710  
19 cm, 7 1/2"



# RIB SHEARS, STERNUM CHISEL

Rippenscheren, Sternummeißel  
Costotomos, Cinceles

Costotomes, ciseau-Burin à sternum  
Costotomi, Scalpello per sterno

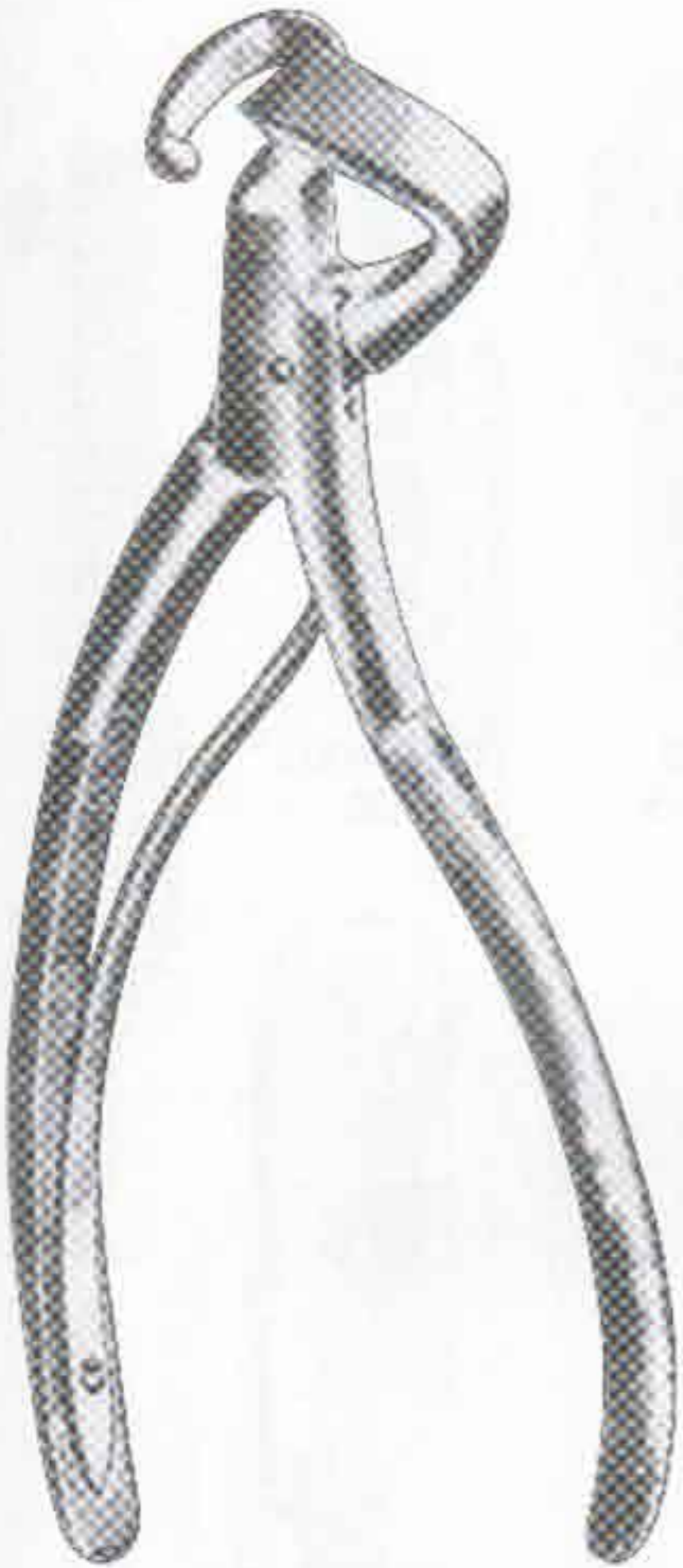

**DOYEN**  
08-720  
19 cm, 7 1/4"



**LEBSCHER**  
**STERNUM CHISEL**  
08-730  
24.5 cm, 9 3/4"



**SEMB**  
08-740  
20 cm, 8"



**SEMB**  
08-750  
20 cm, 8"

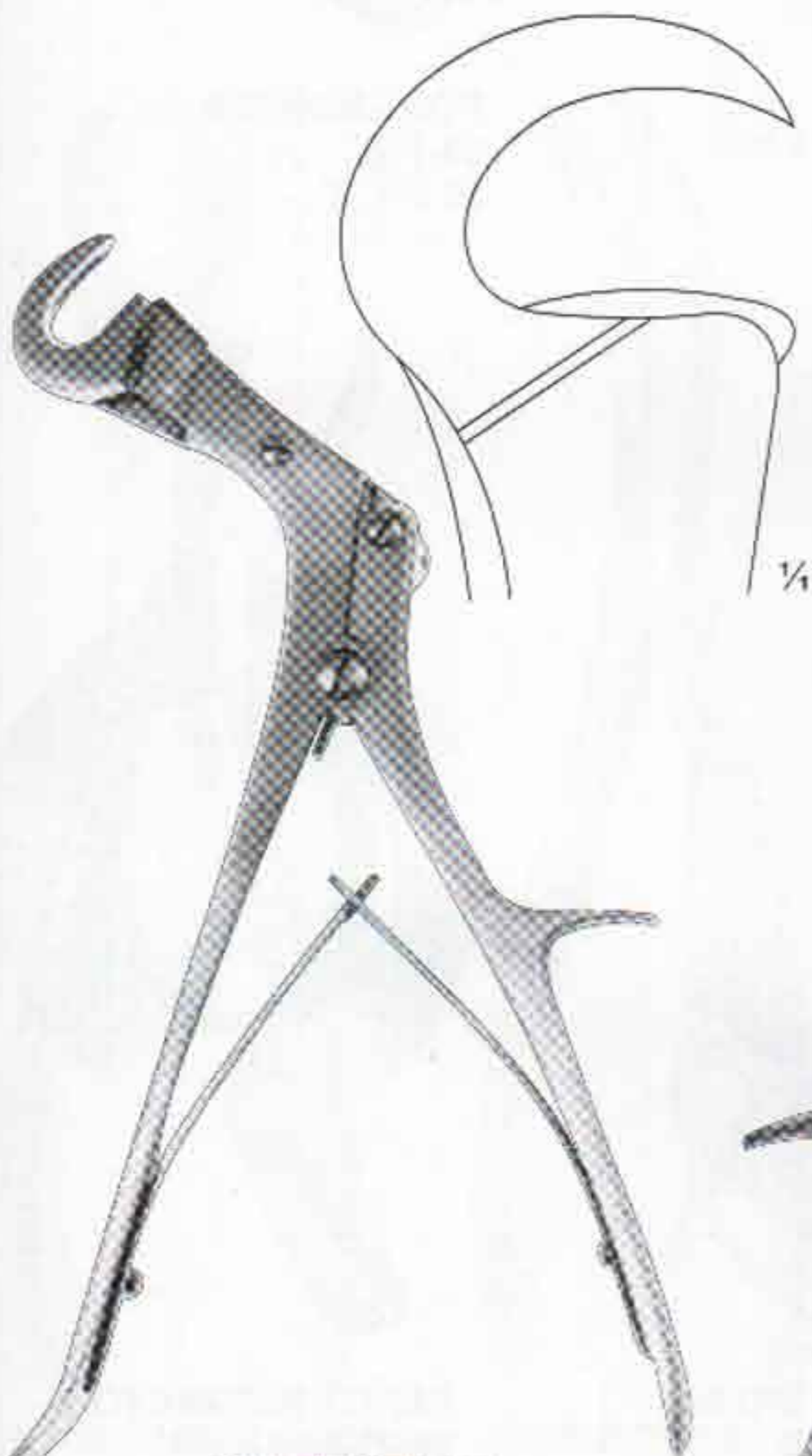

**GIERTZ-STILLE**  
08-760  
27 cm, 10 1/2"

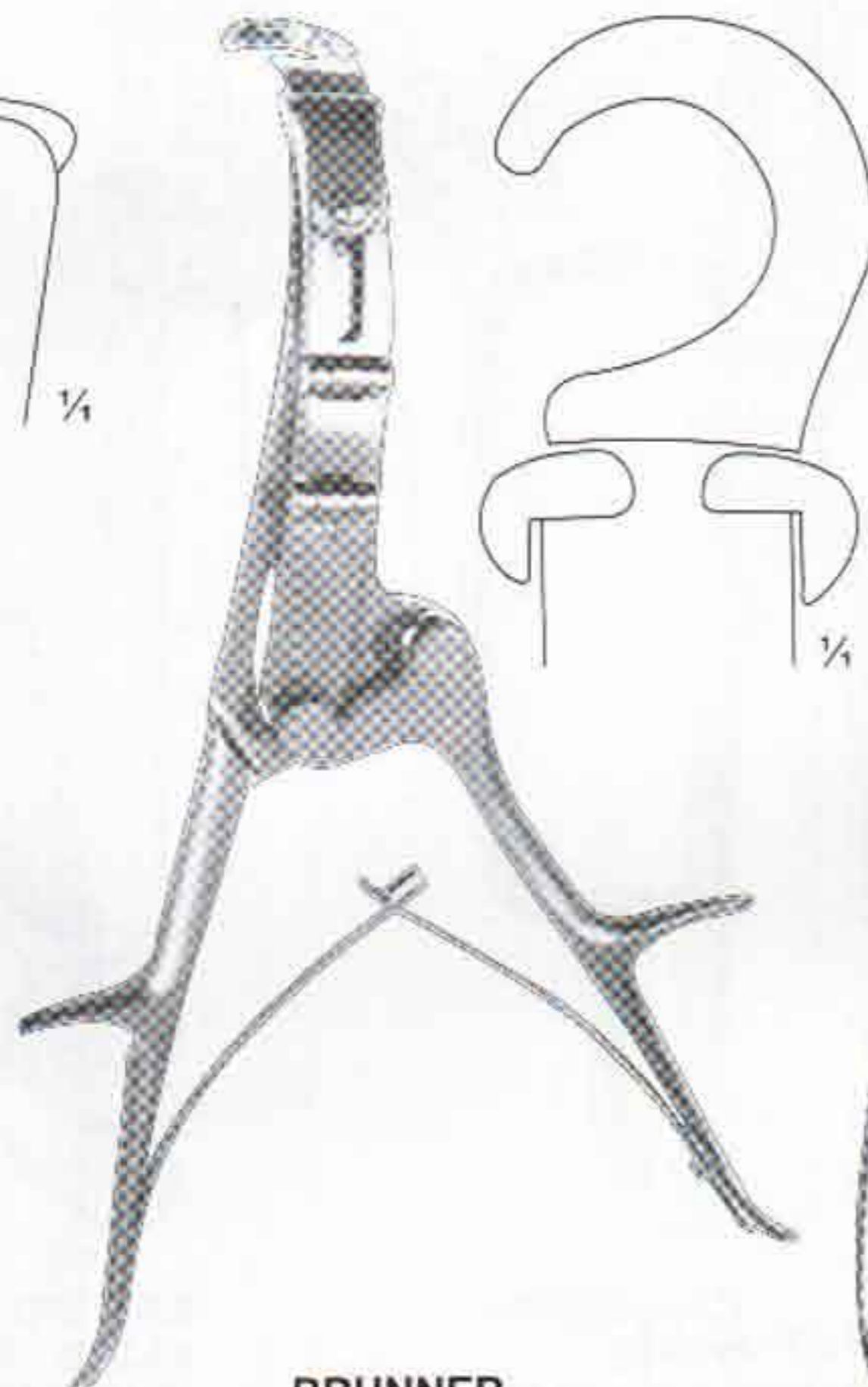

**BRUNNER**  
08-770  
33.5 cm, 13"



**MAURER-COLLIN**

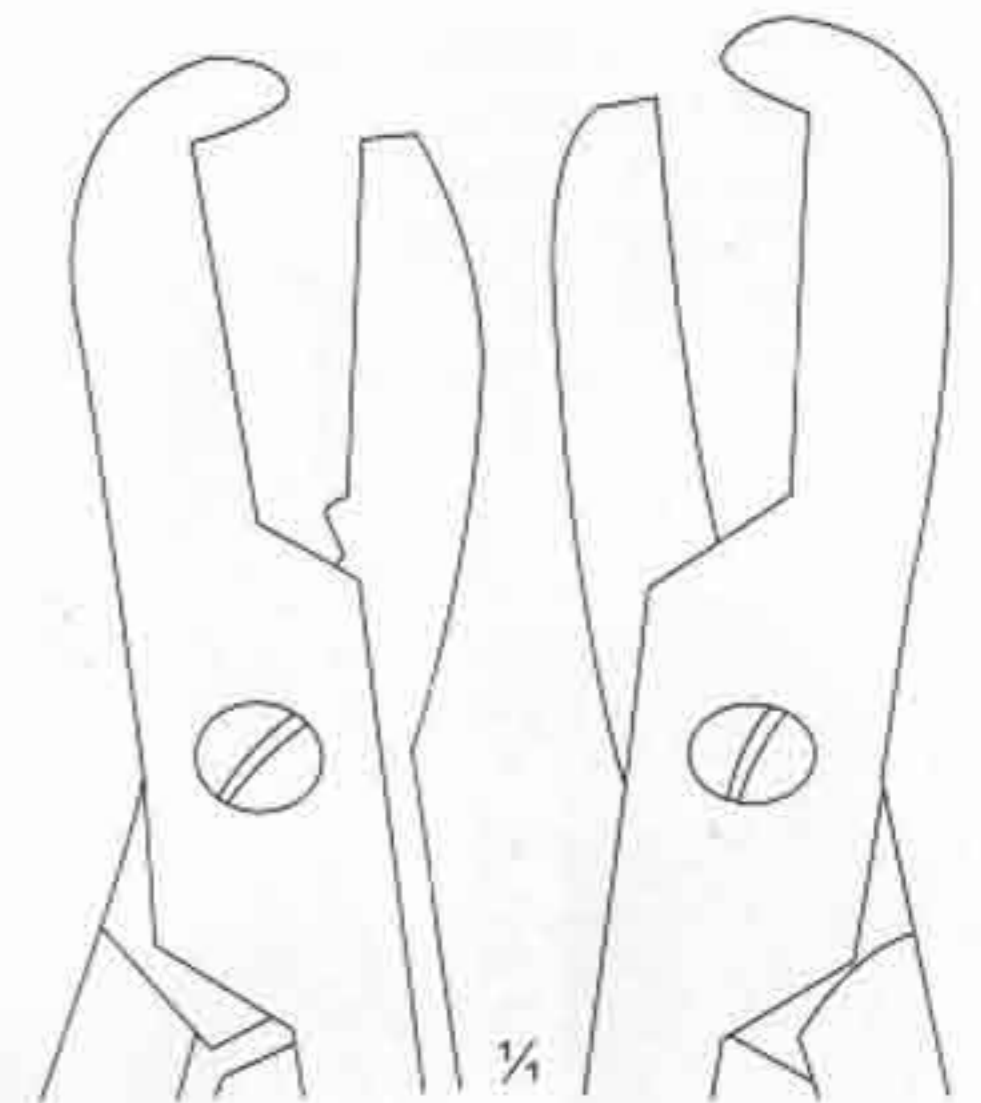

**08-780**  
Hooked Left  
23 cm, 9"

**08-781**  
Hooked Right  
23 cm, 9"



# AMPUTATION SAW

Amputationssägen  
Sierras de amputación

Scies à amputation  
Seghe per amputazione

## BONE DRILLS

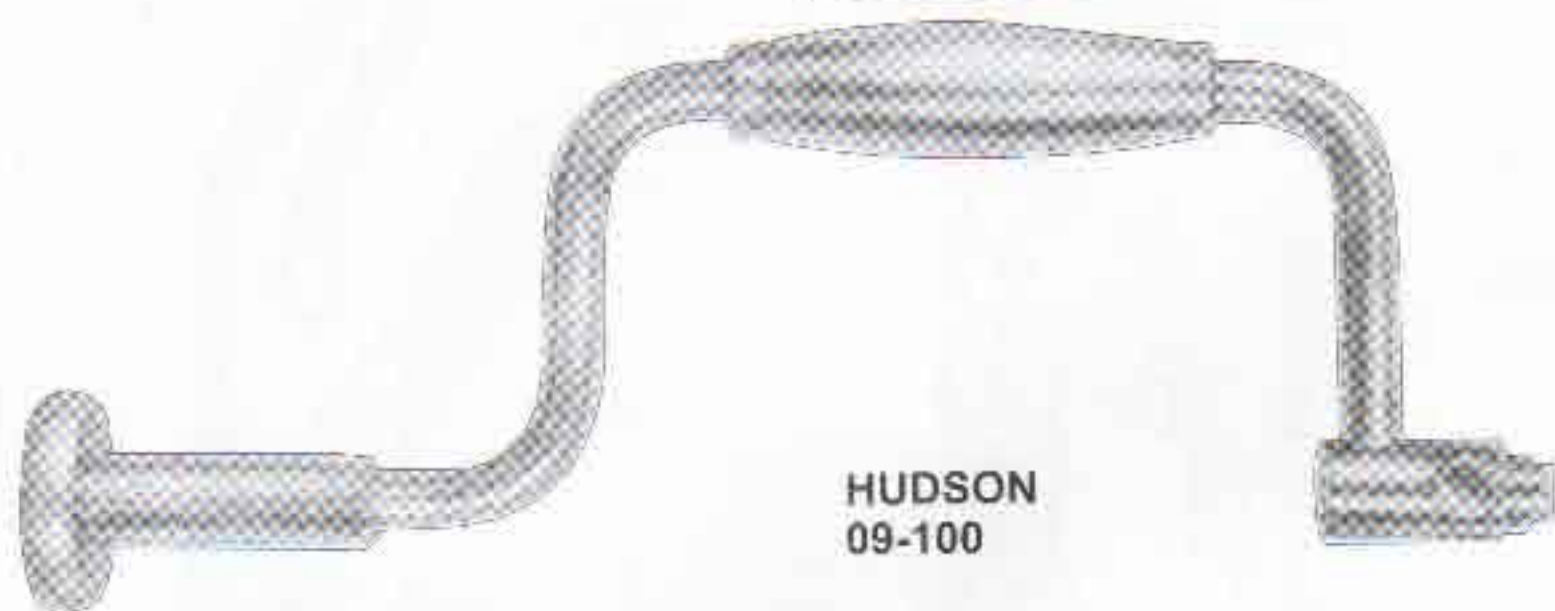

**HUDSON**  
09-100



**Fig. 1**  
09-105



**Fig. 2**  
09-110



**Fig. 3**  
09-115



**CUSHING**  
09-120



09-125



**GIGLI SAW**  
09-130 30 mm  
09-131 40 mm  
09-132 50 mm  
09-133 70 mm  
stainless



**GIGLI HANDLE**  
09-140

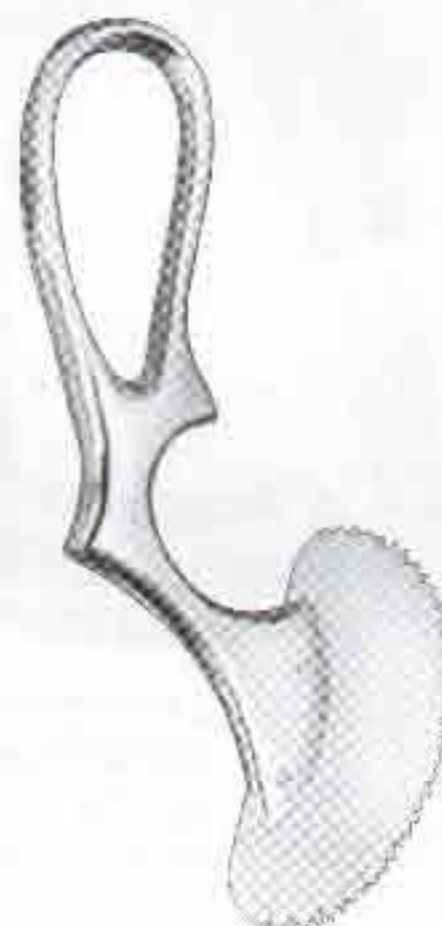

**ENGEL  
PLASTER SAW**  
09-150  
15.5 cm, 6"



**POST MORTEN**  
09-160  
20 cm, 8"

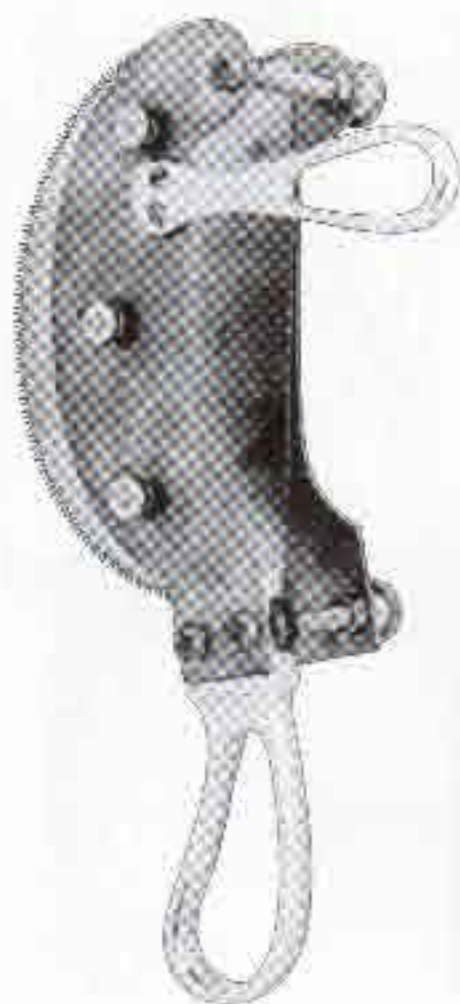

**CHARRIERE**  
09-170 25 cm, 10"  
09-171 27 cm, 10 3/4"  
Double saw



**CHARRIERE**  
09-180 27 cm, 10 3/4"  
09-181 30 cm, 12"

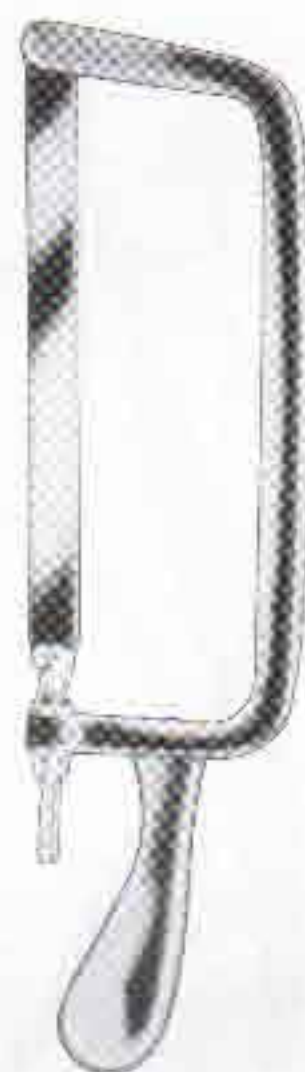

**CHARRIERE**  
09-190  
35 cm, 13 3/4"



**SATTERLEE**  
09-200  
31cm, 12 1/4"



**PERCY RETRACTOR**  
09-210



# BONE HOLDING FORCEPS

Repositionszangen  
Pinzas para reposición

Pinces à réduction  
Pinze per riposizioni



09-220

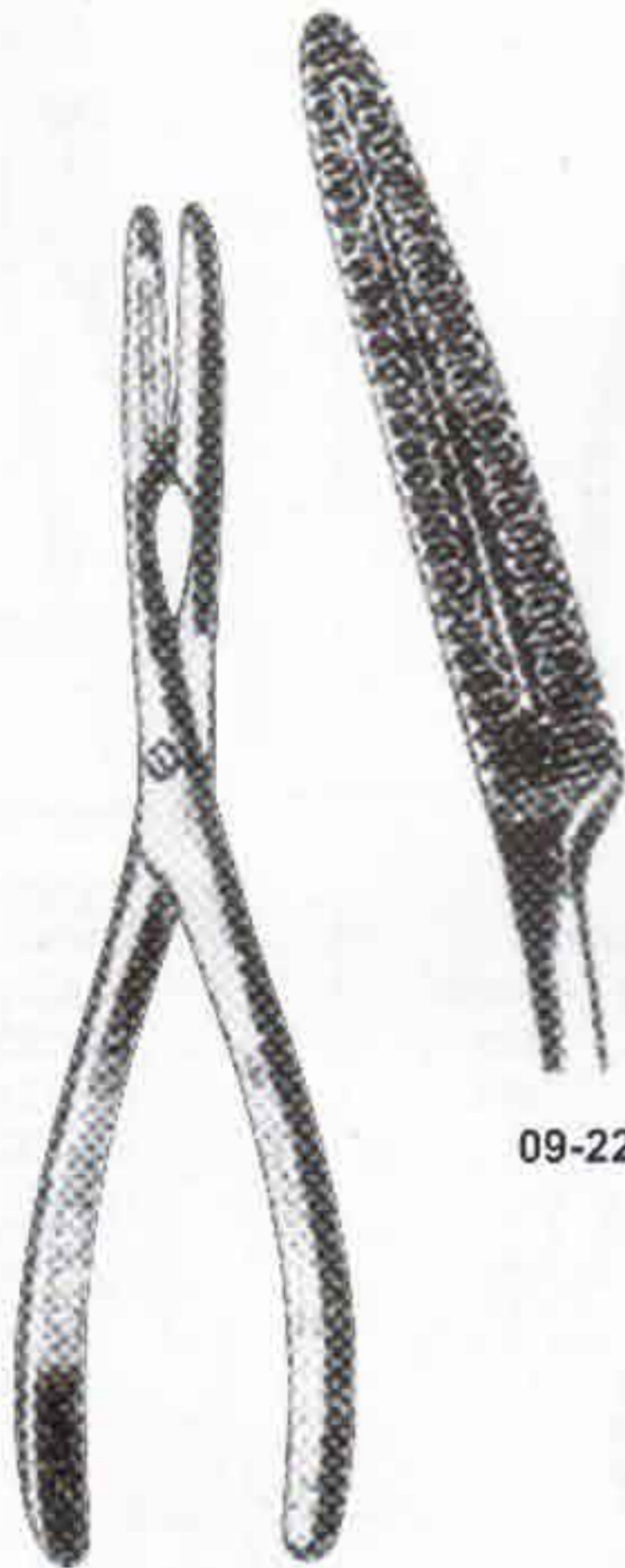

09-221

**SEQUESTRUM**  
09-220 27cm  
09-221 29cm



**VAN BUREN**  
09-230 27cm

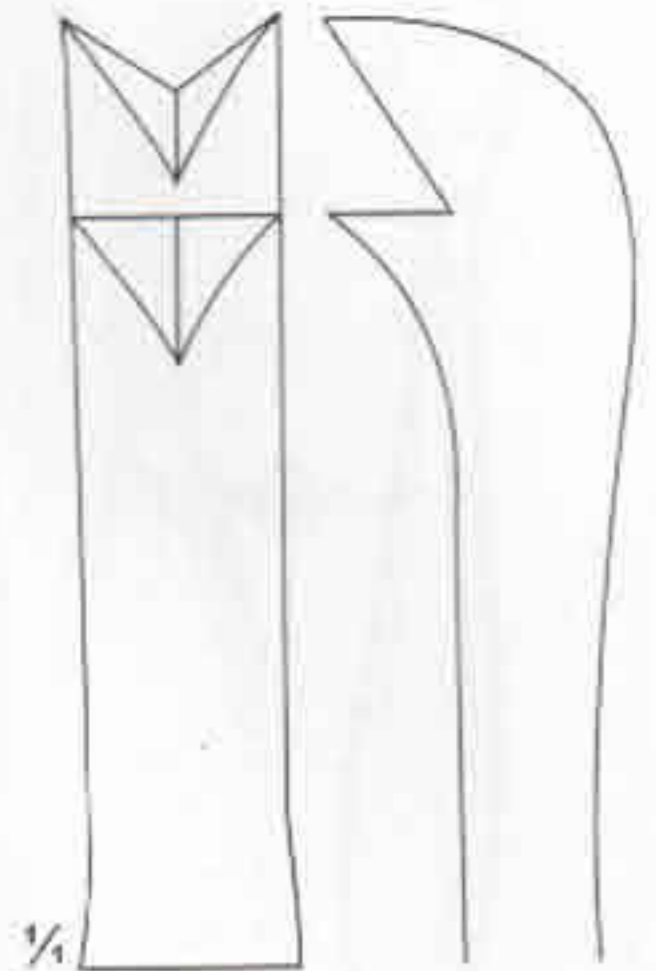
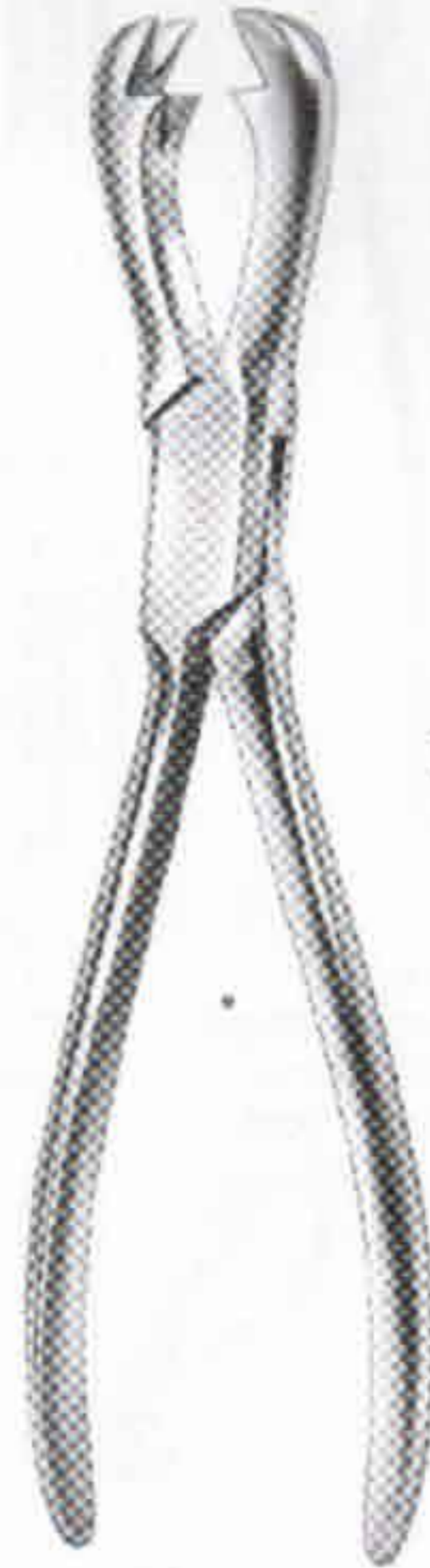

heavy pattern

**FERGUSSON BONE HOLDING FORCEPS**  
09-240  
21cm



**LANGENBECK BONE HOLDING FORCEPS**  
09-250  
21cm

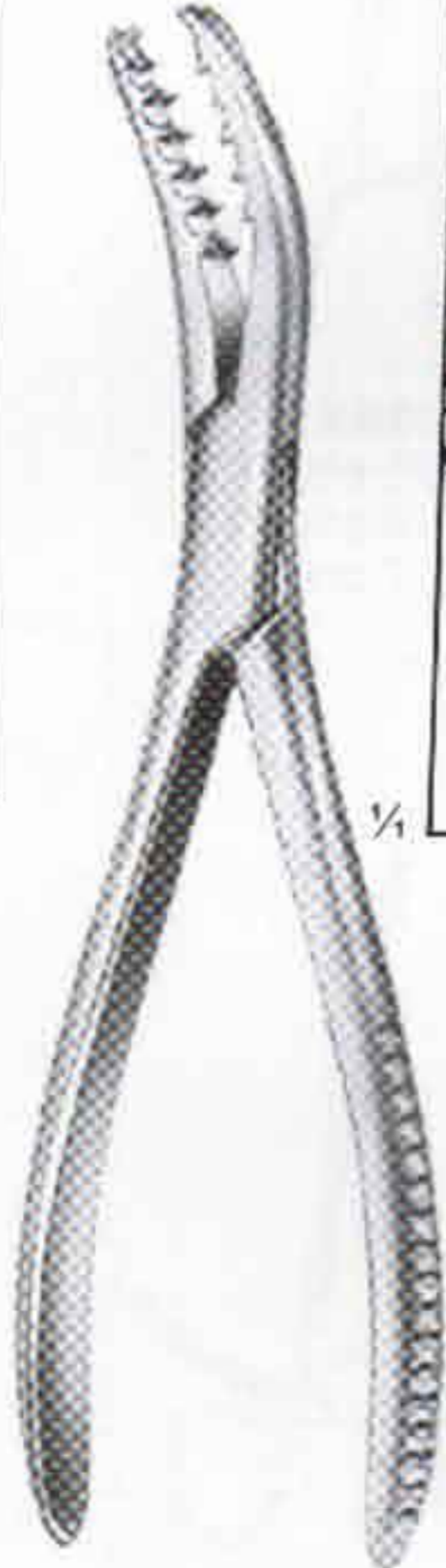

**SEMB BONE HOLDING FORCEPS**  
09-260  
19cm

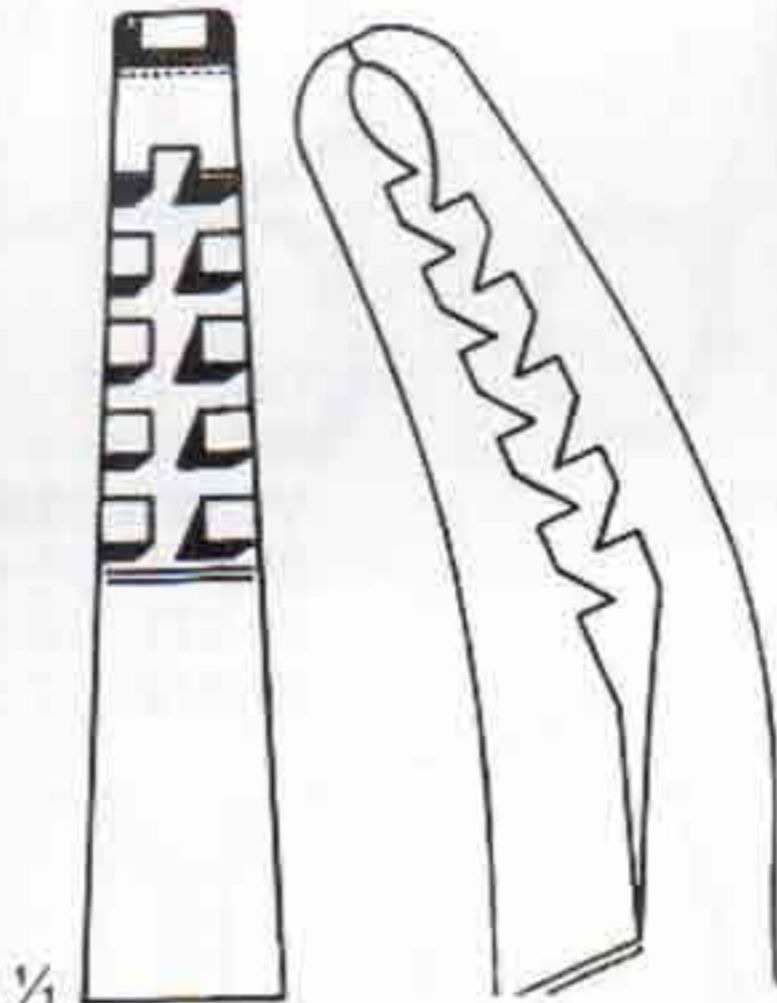

curved sideways



**FARABEUF BONE HOLDING FORCEPS**  
09-270 23cm  
09-271 26cm

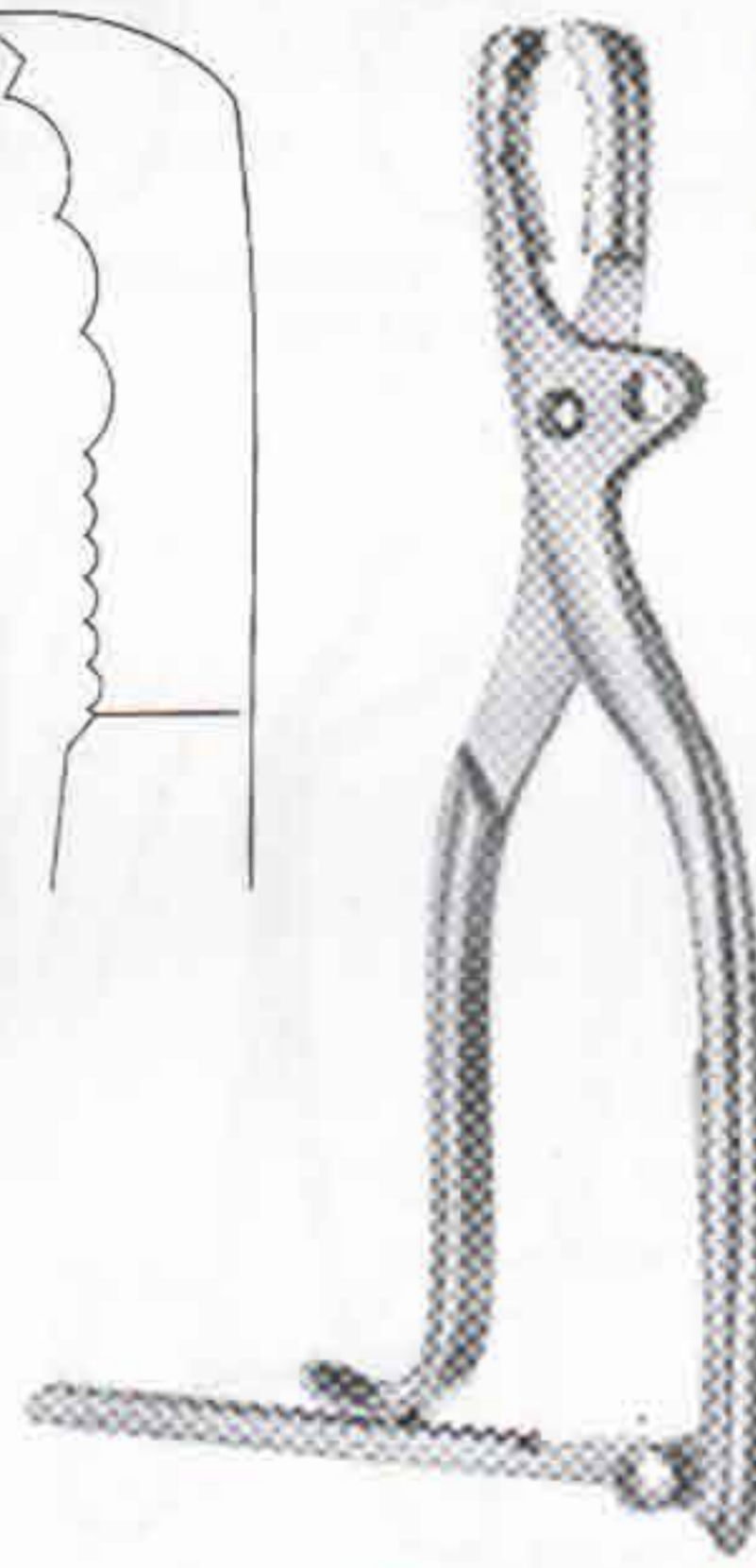
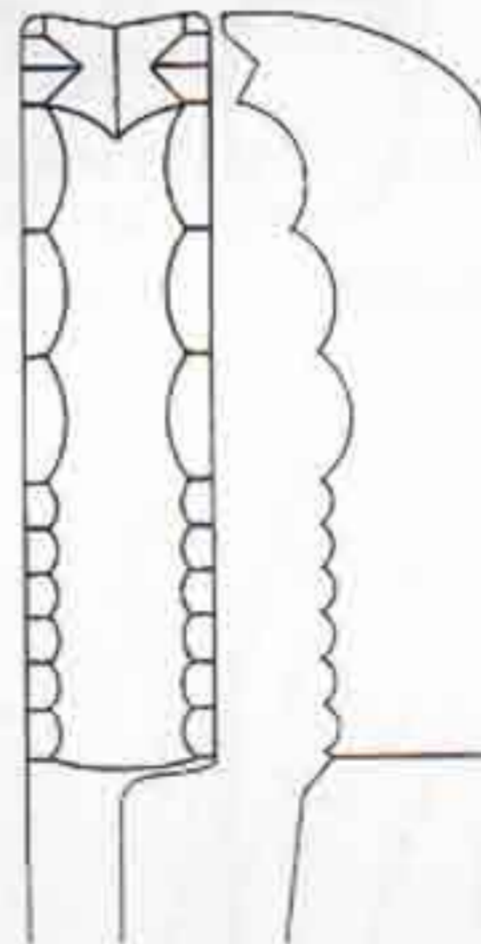

**FARABEUF BONE HOLDING FORCEPS**  
09-280  
26cm

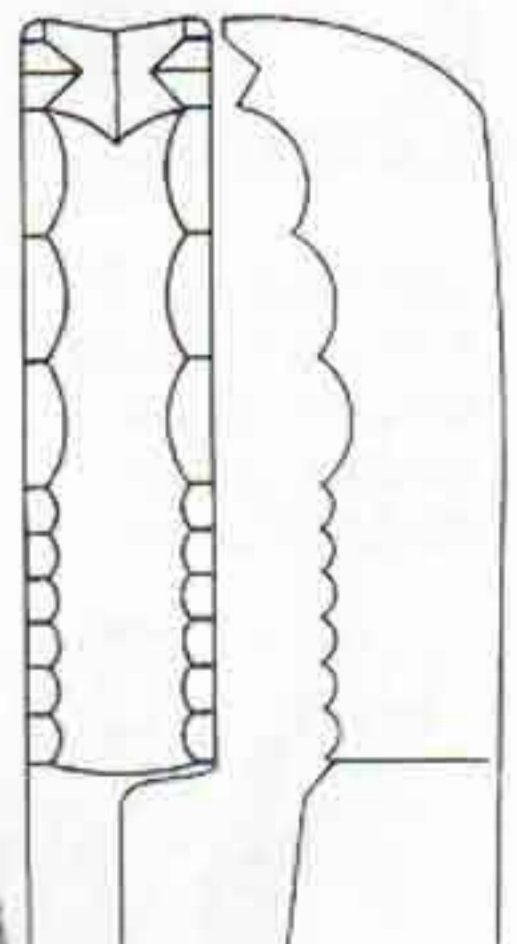



# BONE HOLDING FORCEPS

Repositionszangen  
Pinzas para reposición

Pinces à réduction  
Pinze per riposizioni



Lane Bone Holding Forceps  
09-290 31.5cm  
09-291 39cm



Lane Bone Holding Forceps  
09-300 33cm  
09-301 45cm

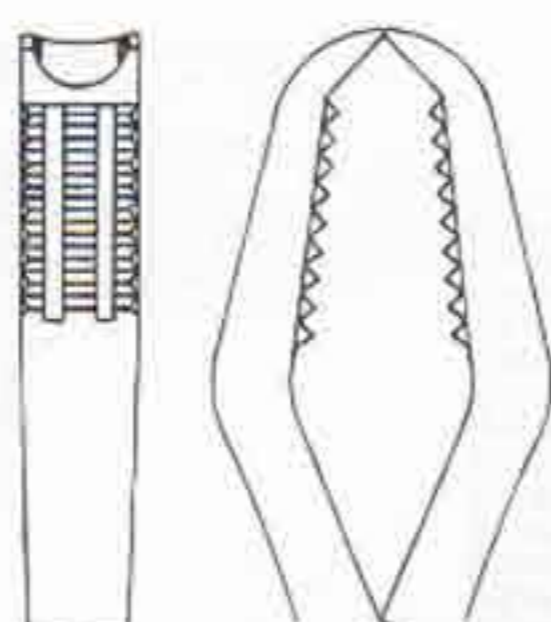

without ratchet

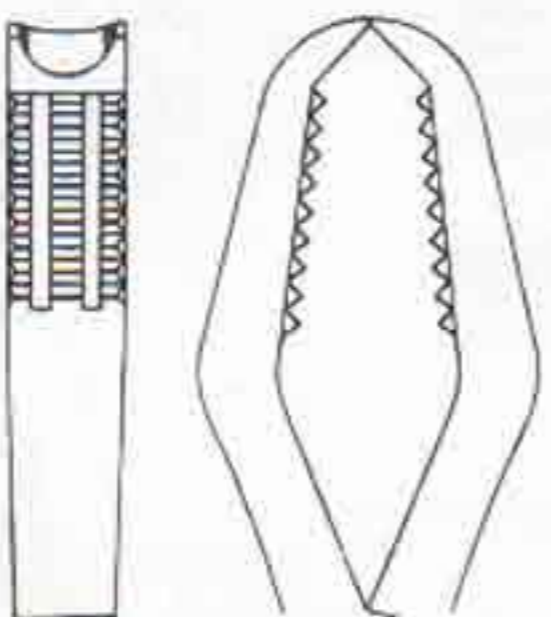

with ratchet



Kern Bone Holding Forceps  
09-310 17cm  
29-311 21cm

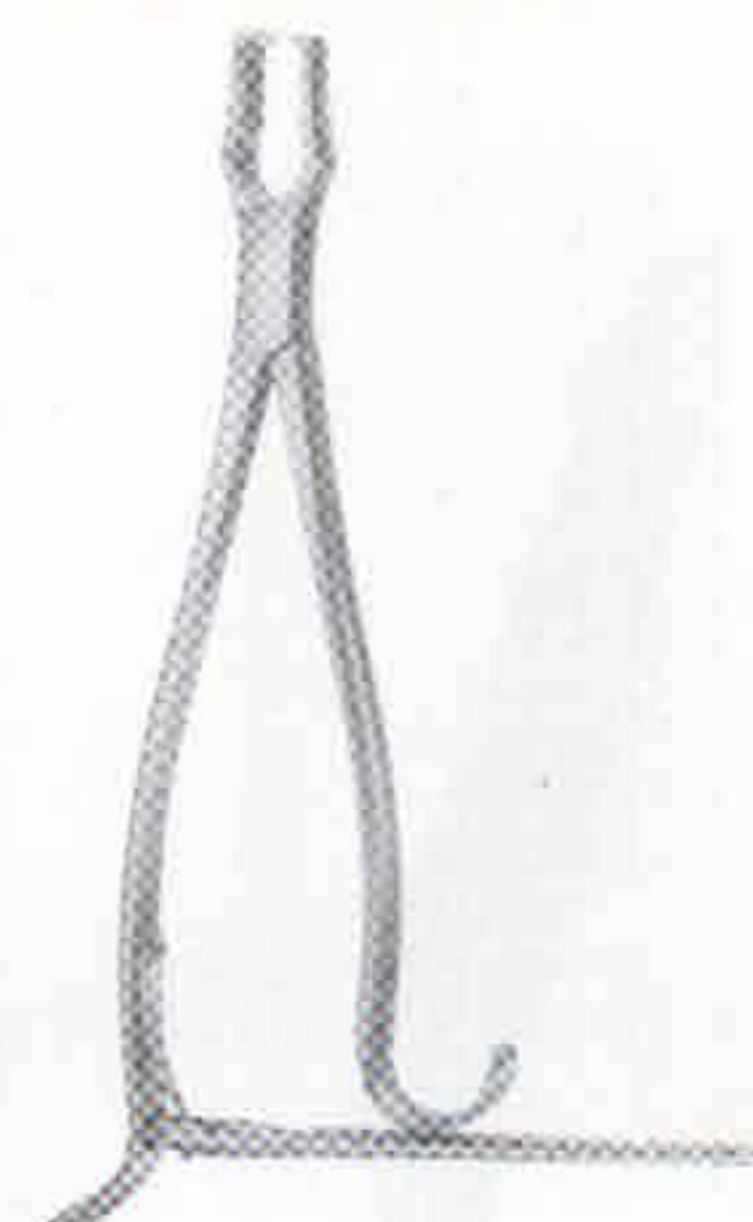

Kern Bone Holding Forceps  
09-320 17cm  
09-321 21cm



Lambotte Bone Holding Forceps  
09-330 19cm  
09-331 23cm  
09-332 26cm

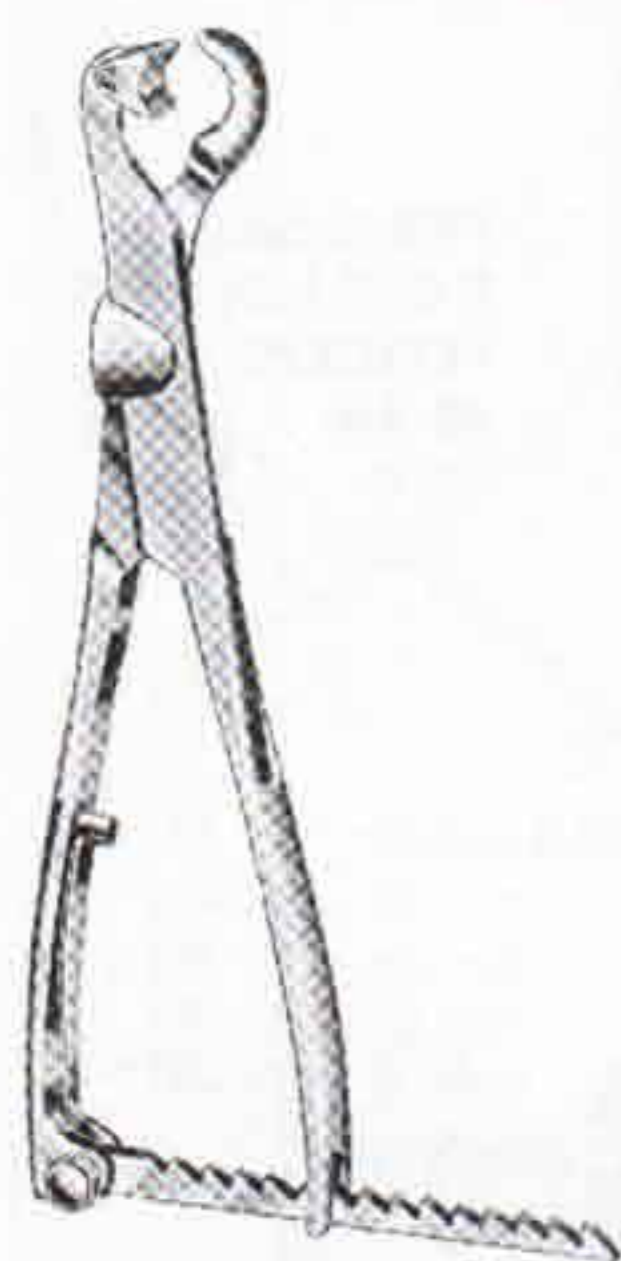

Lambotte Bone Holding Forceps  
09-340 22cm  
09-341 26cm  
09-342 33cm



VERBRUGGE  
09-350  
18 cm, 7"

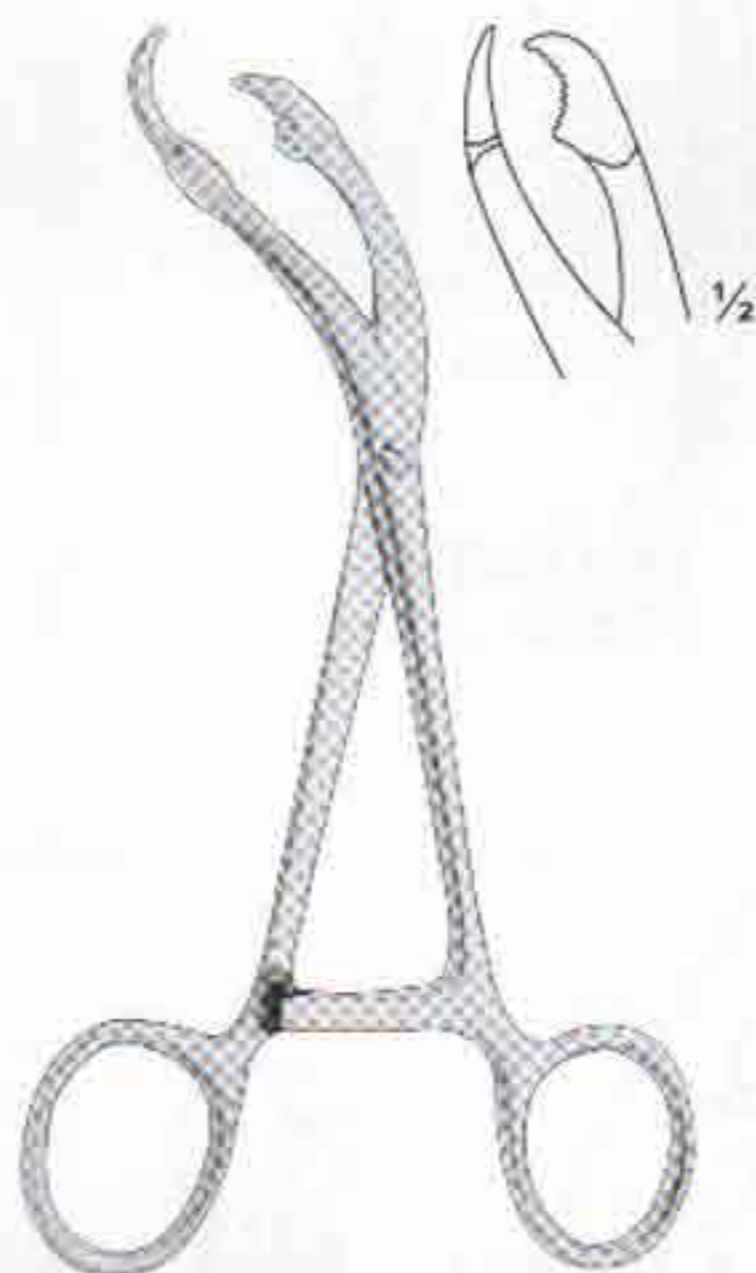

VERBRUGGE  
09-360  
18 cm, 7"



VERBRUGGE  
09-370 25 cm, 10"  
09-371 26 cm, 10 1/4"  
09-372 27 cm, 10 1/2"

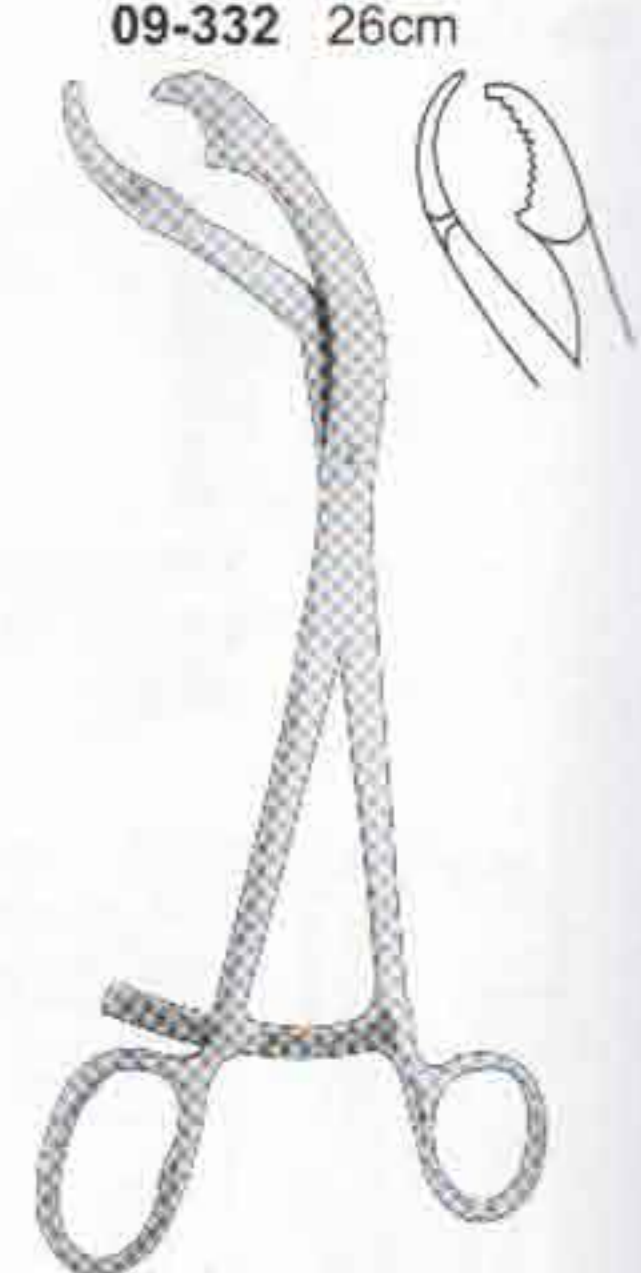

VERBRUGGE  
09-380 25 cm, 10"  
09-381 26 cm, 10 1/4"  
09-382 27 cm, 10 1/2"

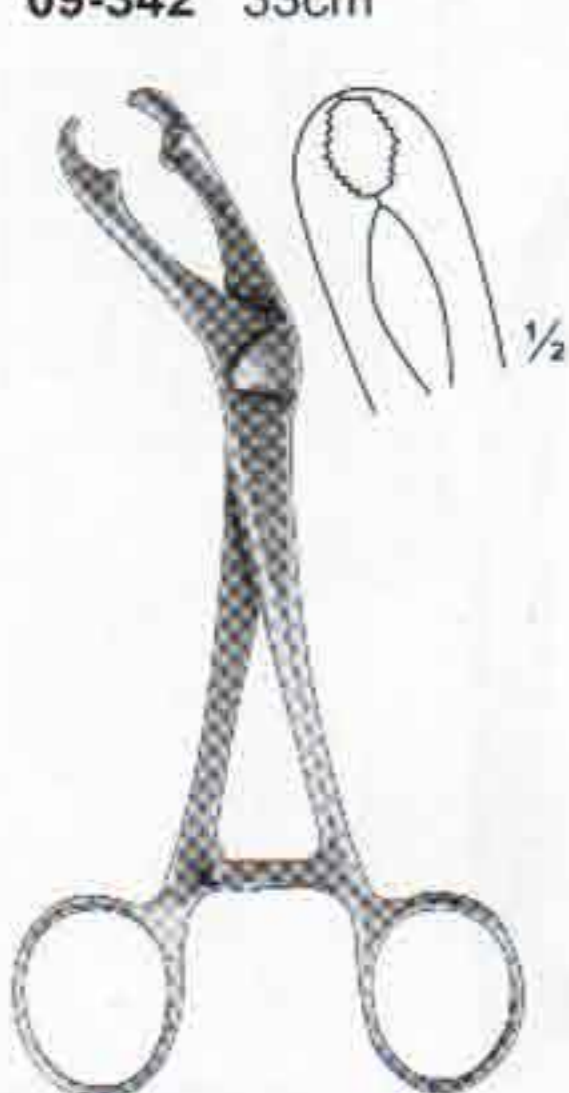

VERBRUGGE  
09-390  
18 cm, 7"

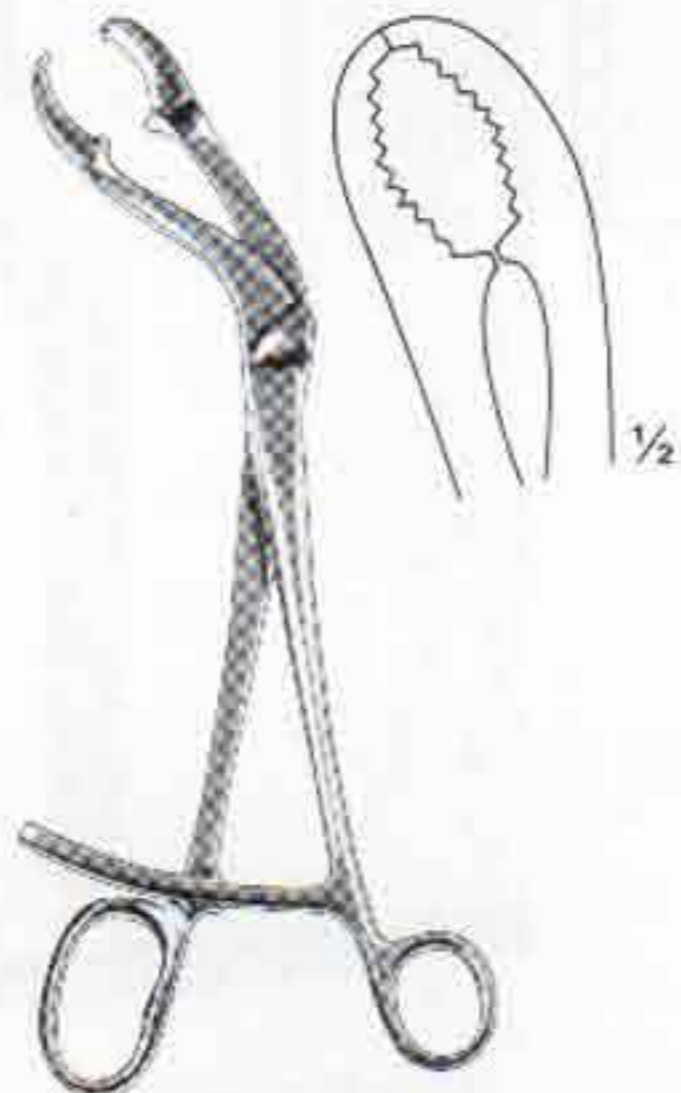

VERBRUGGE  
09-400 25 cm, 10"  
09-401 26 cm, 10 1/4"  
09-402 27 cm, 10 1/2"



REIL  
09-410  
17 cm, 7"



REDUCTION FORCEPS  
09-420  
20 cm, 8"  
with Points



09-430 17 cm, 7"  
For fingers, with drill  
Guide for Kirschner  
Wires up to 1 mm



# BONE HOLDING FORCEPS, REPOSITION FORCEPS

Knochenfazzange, Repositionszangen  
Pinzas para hueso, Pinzas para reposición

Daviers porte-so, Pincas à réduction  
Tenaglie per ossa, Pinze per riposizioni

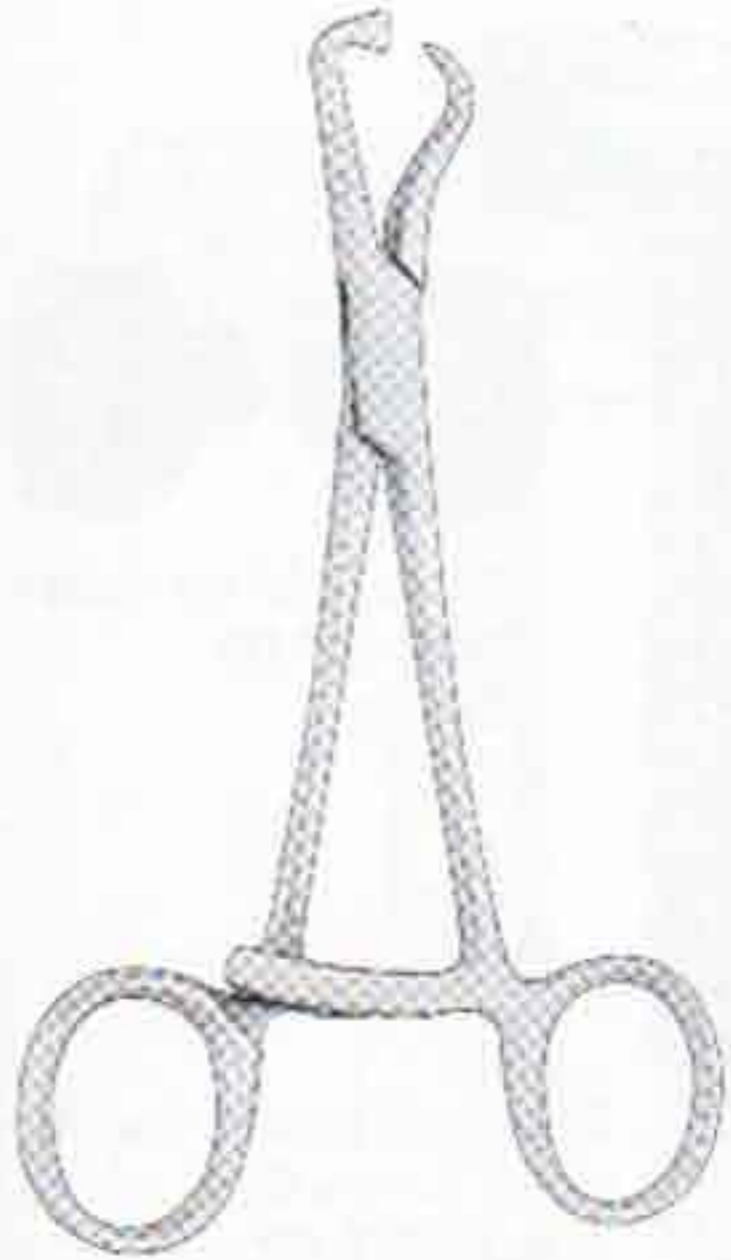

**HOLDING FORCEPS**  
09-440  
13 cm, 5"

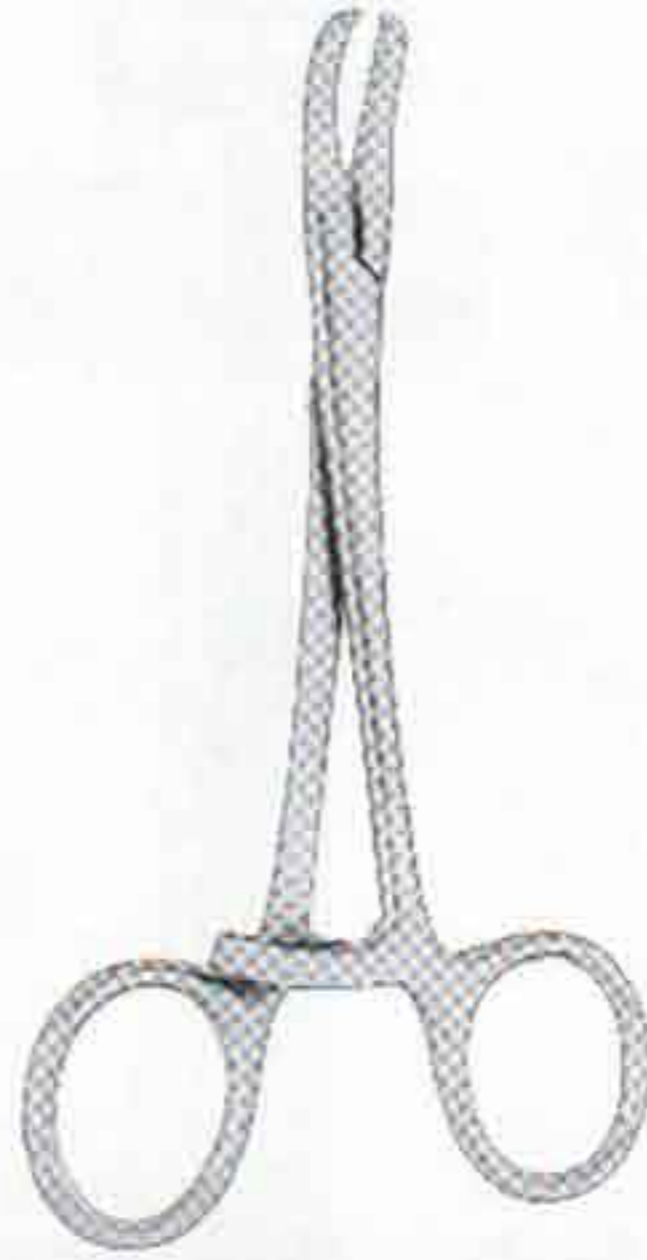

**RATCHET FIXATION FORCEPS**  
09-450  
14.5 cm, 6"

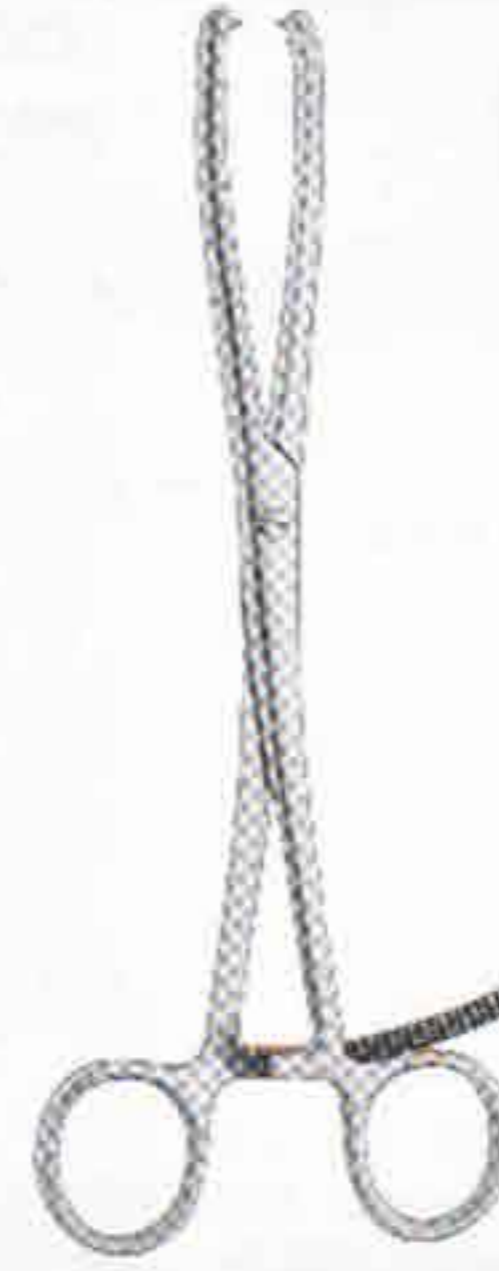

**MALLEOLAR FORCEPS**  
09-460  
20 cm, 8"

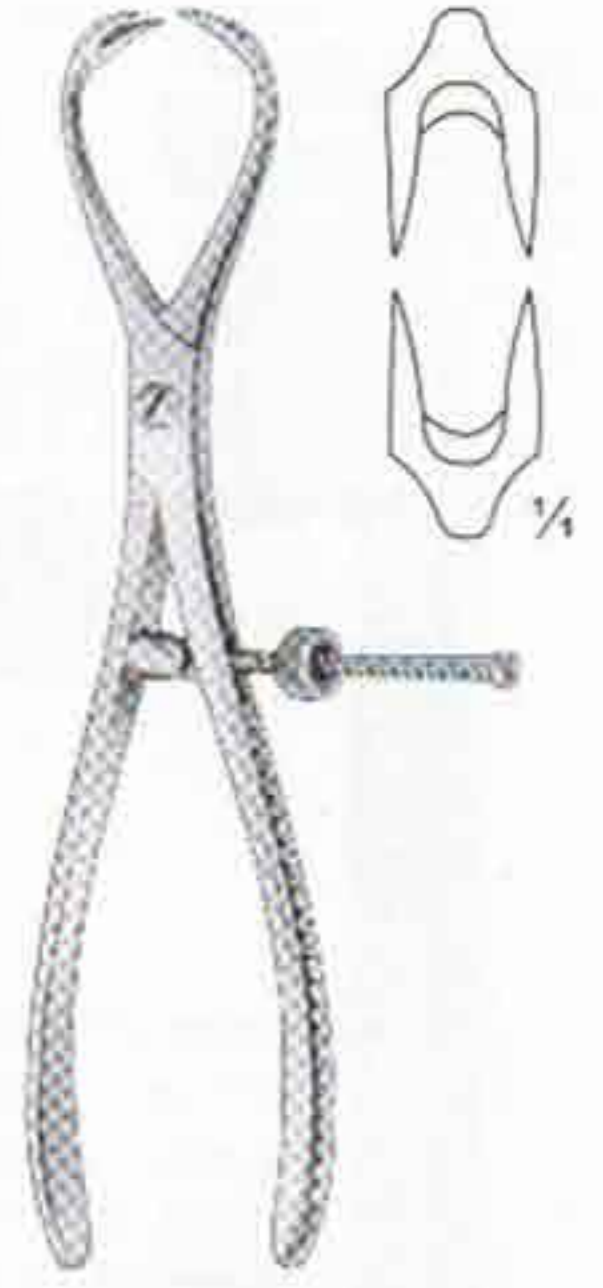

**PATELLA FORCEPS**  
09-470  
18.5 cm, 7 1/4"

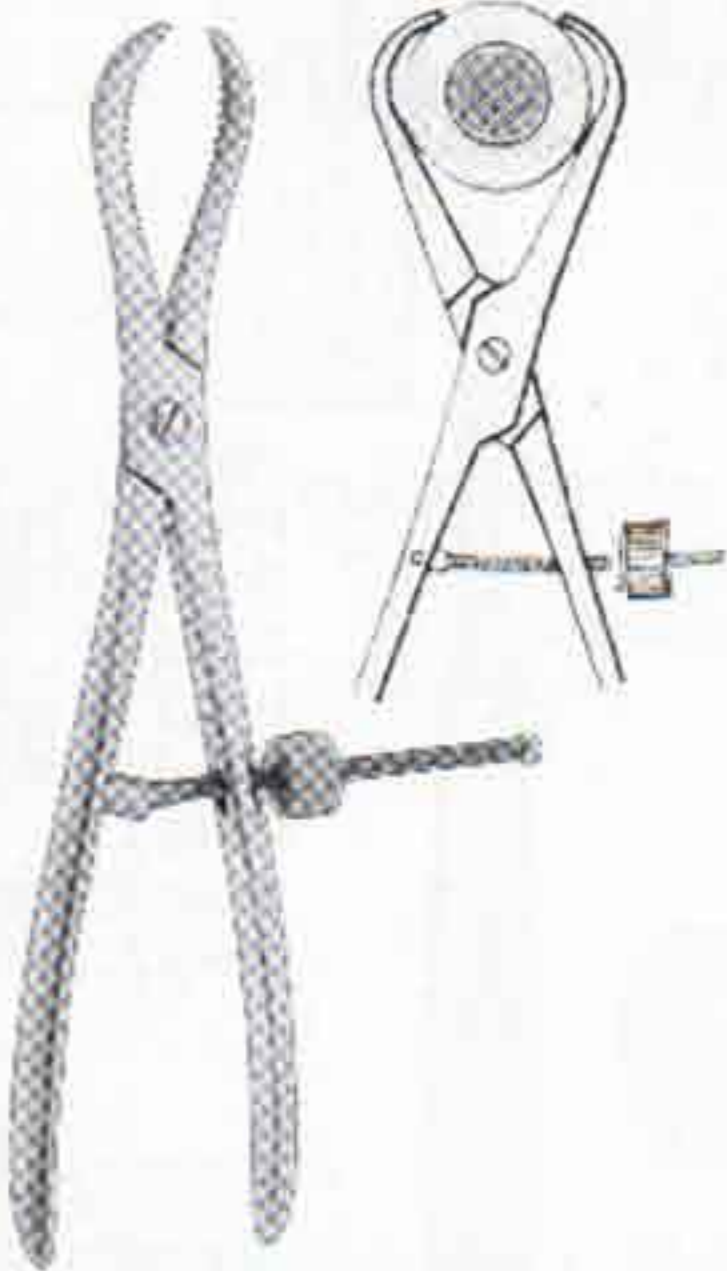

**REDUCTION FORCEPS**  
09-480 16 cm, 6 1/2"  
09-481 24 cm, 9 1/2"  
with Thread Lock

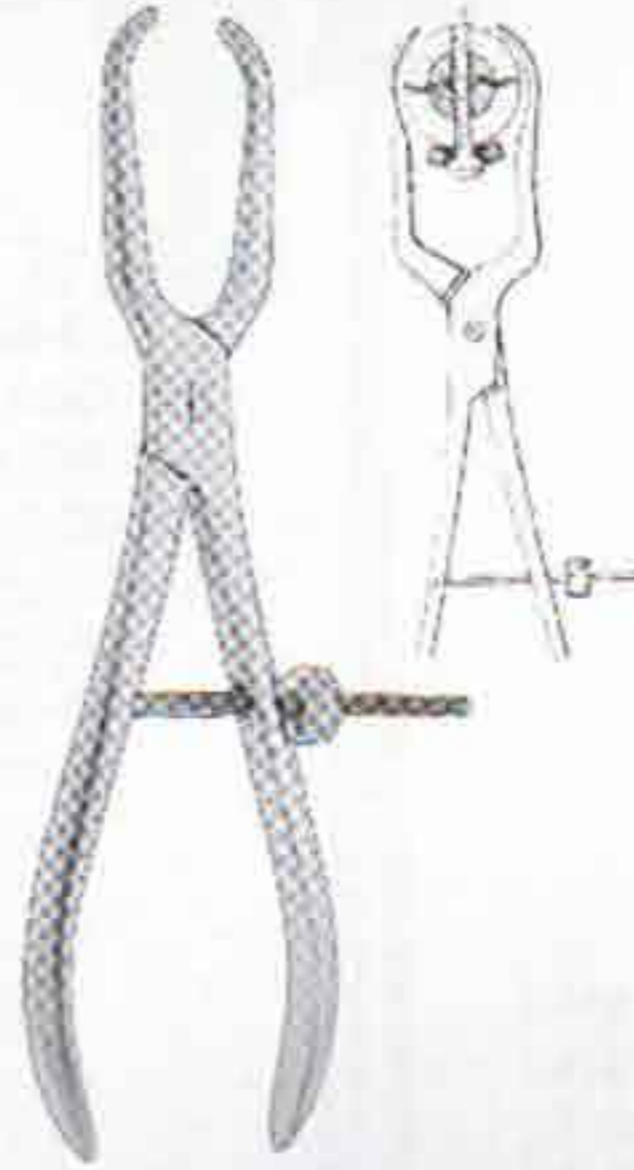

**REPOSITION FORCEPS**  
09-490  
23 cm, 9"

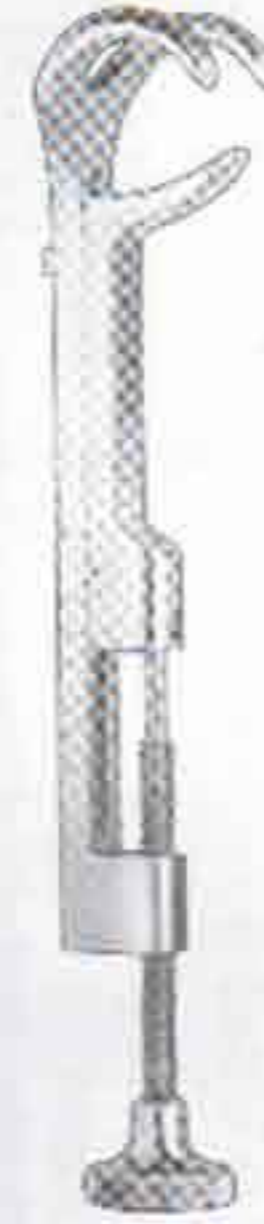

**LOWMANN BONE CLAMP**  
09-500 18.0 cm, 7"  
09-501 20.0 cm, 8"  
09-502 22.0 cm, 8 3/4"



**LOWMAN-HOGLUND**  
09-510  
17.5 cm, 7"

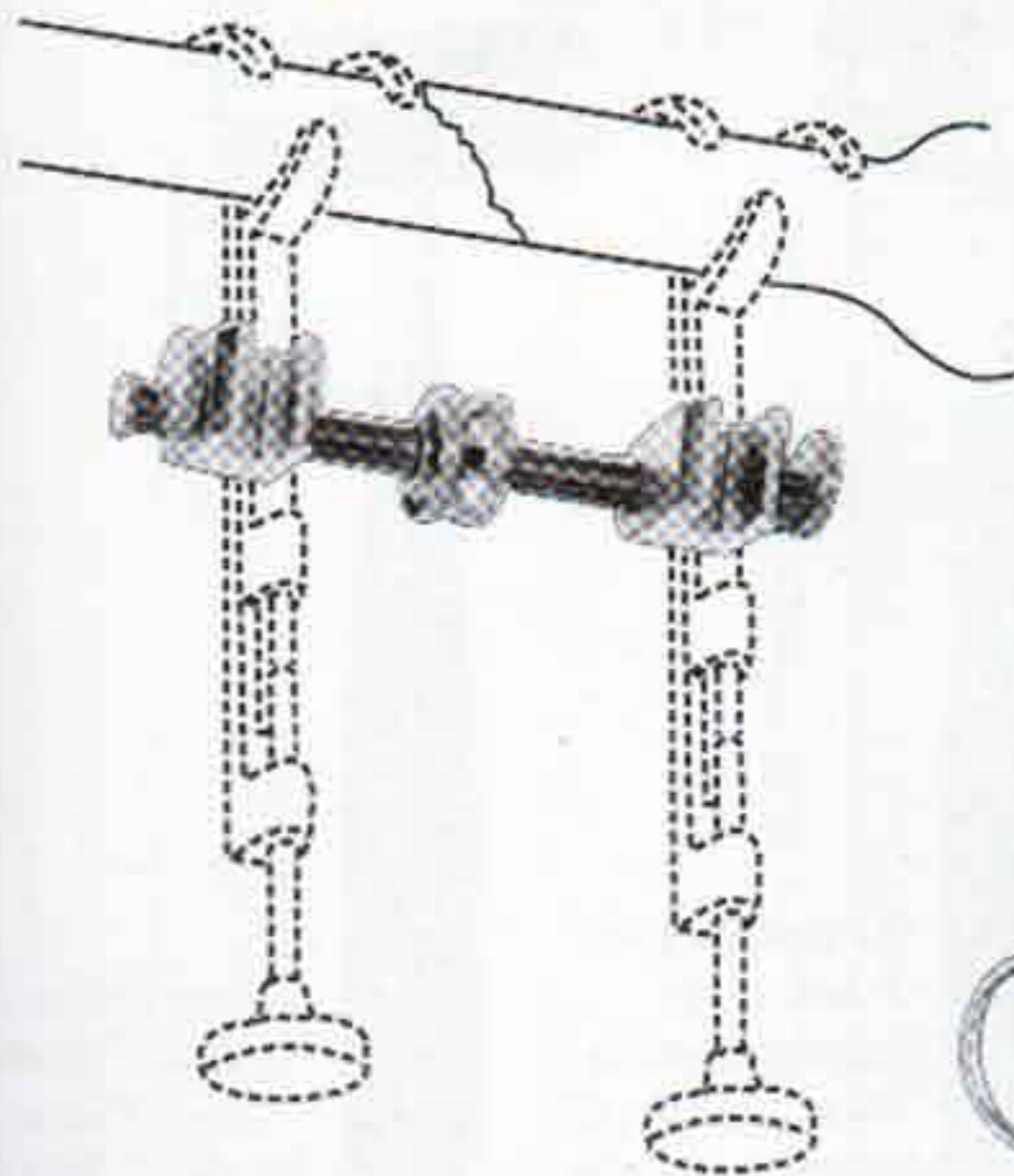

**GERSTER**  
09-520 18 cm, 7"  
09-521 20 cm, 8"  
09-522 22 cm, 9"

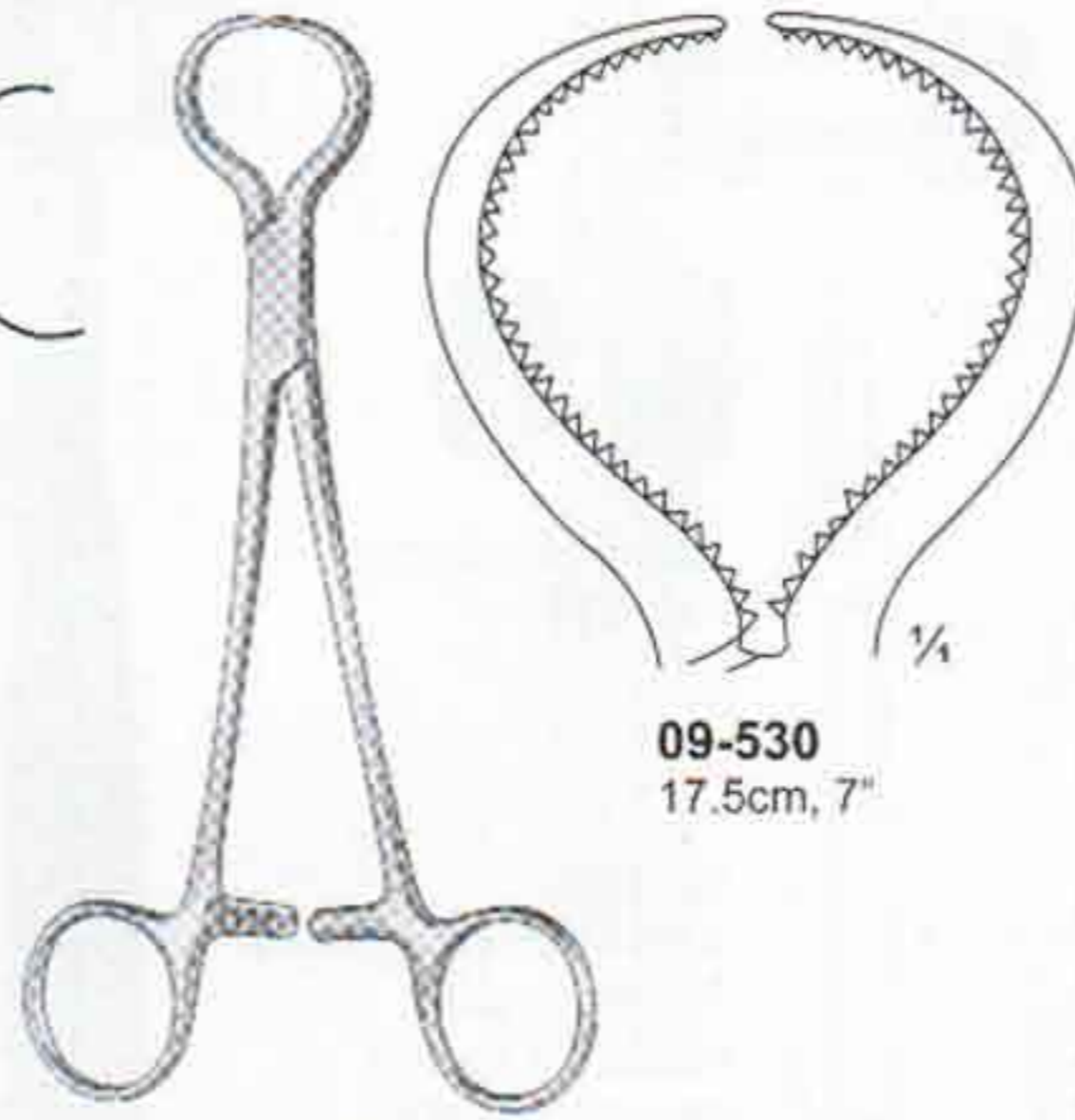

**LEWIN**

09-530  
17.5cm, 7"

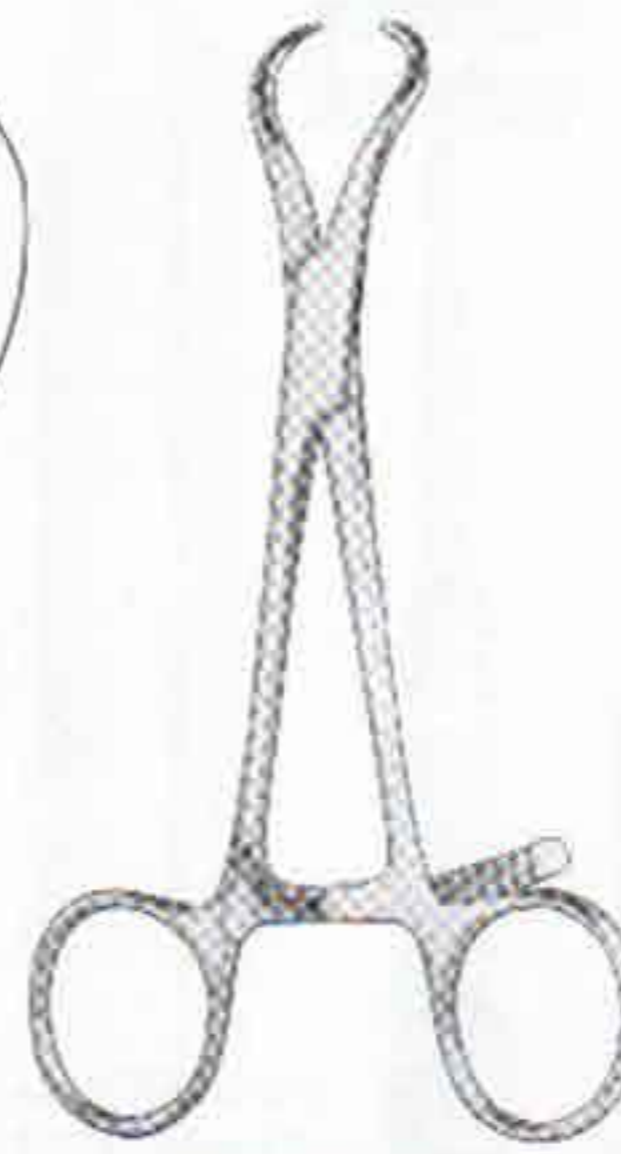

**ORTHO FORCEPS**  
09-540 13 cm, 5"

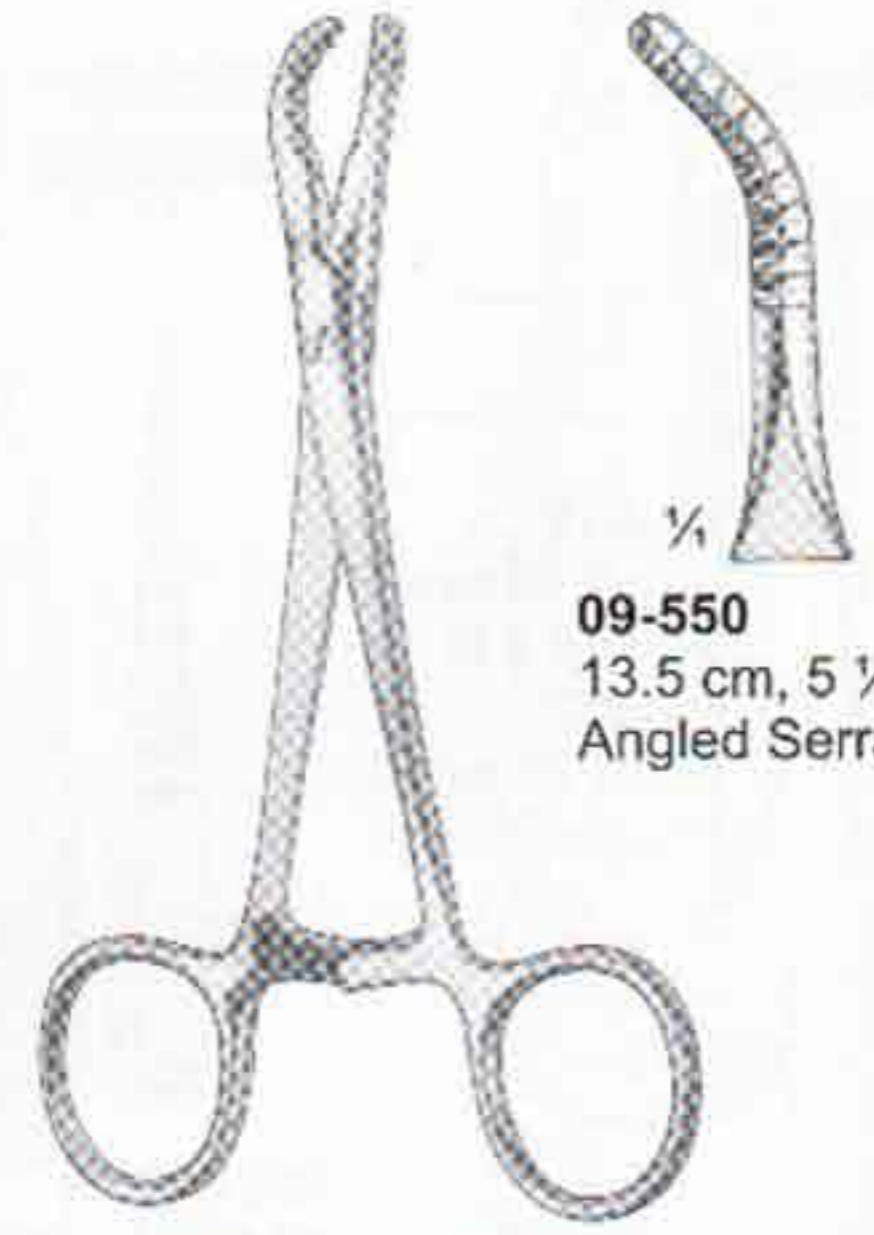

09-550  
13.5 cm, 5 1/2"  
Angled Serrated



# MALLETS

Hämmer  
Martillos

Maillets  
Martelli



plane (nylon)  
convex (steel)  
plastic handle  
Head 30mm Ø  
Weight 675 Gr.

**MALLET**  
09-560  
26 cm, 10 1/2"



plastic handle  
Head 42 / 30mm Ø  
Weight 530 Gr.

**MALLET**  
09-570  
26 cm, 10 1/4"



plastic handle  
Head 30mm Ø  
Weight 480 Gr.

**MALLET**  
09-580  
24 cm, 9 1/2"



Plastic Handle  
Head 30mm Ø  
Weight 510 Gr.

**MALLET**  
09-590  
26 cm, 10 1/4"



disks and plastic handle  
Head 37mm Ø  
Weight 370 Gr.

**MALLET**  
09-600  
22.5 cm, 9"



Spare Facing (pair)  
Pi09-448-00  
Plactic



made of plastic  
Head 30mm Ø  
Weight 125 Gr.

**MALLET**  
09-610  
18 cm, 7"



made of plastic  
with lead filling  
Head 42mm Ø  
Weight 400 Gr.  
Head 42mm Ø  
Weight 250 Gr.

**MALLET**  
09-620  
26 cm, 10 1/4"



made of plastic  
with lead filling  
Head 42mm Ø  
Weight 250 Gr.

**MALLET**  
09-630  
26 cm, 10 1/4"



**WILLIGER**  
09-640  
24 cm, 9 1/2"

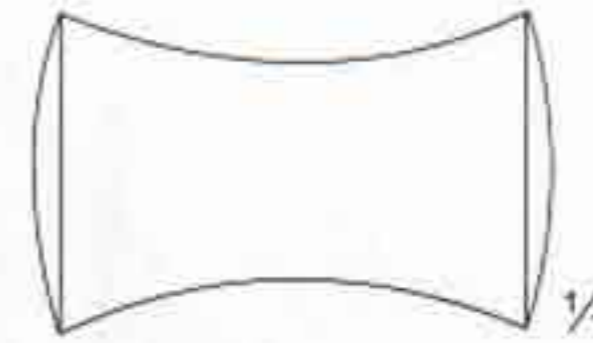

09-641  
Head 26 mm Ø  
Weight 300 Gr.  
09-642  
Head 28 mm Ø  
Weight 340 Gr.  
09-643  
Head 30 mm Ø  
Weight 400 Gr.



**DOYEN**  
09-650  
21 cm, 8 1/4"

09-651  
Head 25 mm Ø  
Weight 120 Gr.  
09-652  
Head 30 mm Ø  
Weight 180 Gr.  
09-663  
Head 35 mm Ø  
Weight 260 Gr.

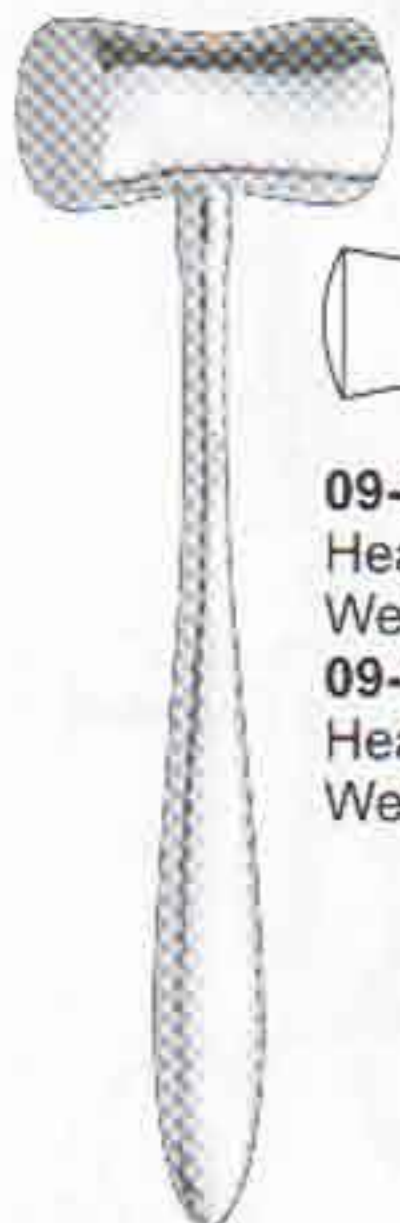

09-661  
Head 19 mm Ø  
Weight 230 Gr.  
09-662  
Head 25 mm Ø  
Weight 260 Gr.

**LUCAE**  
09-660  
19 cm, 7 1/2"



**WILLIGER**  
09-670  
16.5 cm, 6 1/2"  
Head 20 mm Ø  
weight 140 Gr.



**PARTSCH**  
09-680  
18 cm, 7"

Head 22mm Ø  
Weight 200 Gr.



**MEAD**  
09-690  
17 cm, 6 3/4"



Spare Facings  
09-691

09-692  
with interchangeable  
Plastic dicks  
Head 26 mm Ø  
Weight 320 Gr.



**HERBERT**  
09-700  
19 cm, 7 1/2"

for ulnar head  
prosthesis  
plastic handle  
Head 25mm Ø  
Weight 300 Gr.



**VICKERS**  
09-710  
19 cm, 7 3/4"

nylon disks  
plastic handle  
Head 25mm Ø  
Weight 300 Gr.



# MALLETS

Hämmer  
Martillos

Maillets  
Martelli

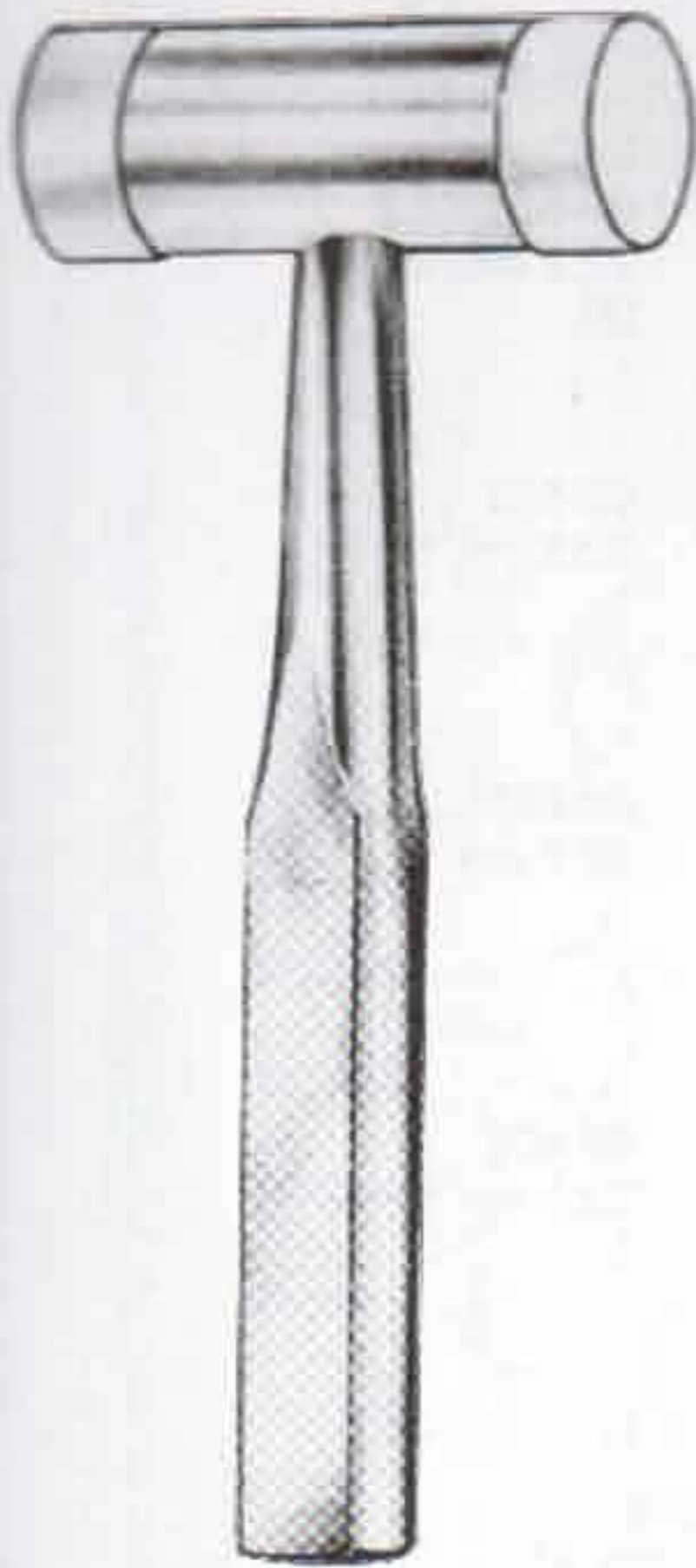

**ORTHO / WITH PLASTIC CAPS**  
**09-720** Pair of spare disks  
18 cm, 7" with interchangeable  
25 mm Dia. plastic disks  
(140g)



**ORTHO**  
**09-730**  
26.5 cm, 10 1/2"  
(450g)



**ORTHOPAEDIC Mallet**  
**09-740**  
19 cm, 7 1/2"

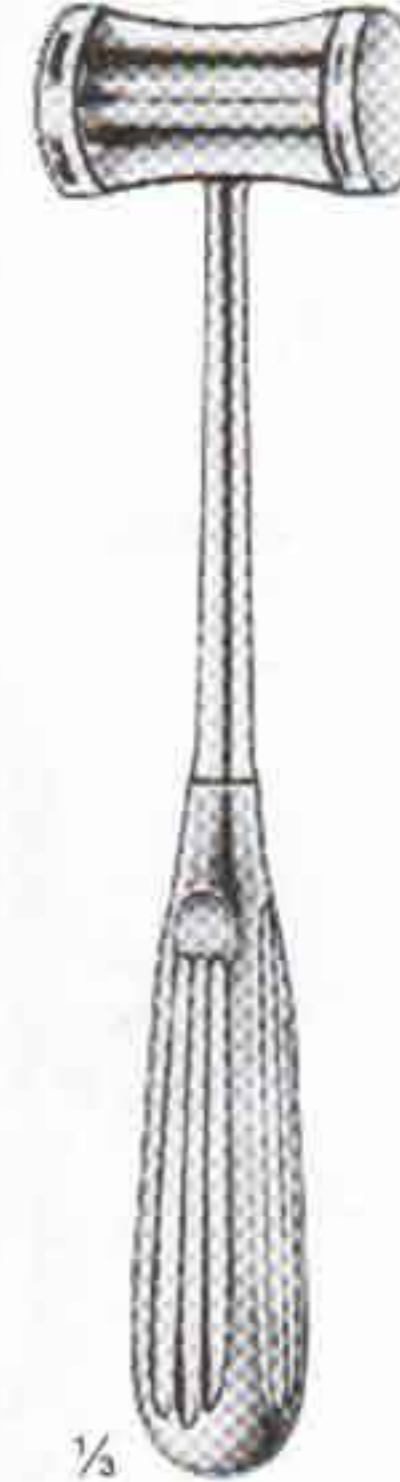

**HAJEK**  
**09-750**  
22 cm, 8 3/4"  
27 mm Dia.  
(140g)



**ORTHO**  
**09-760**  
26.5 cm  
(450g)

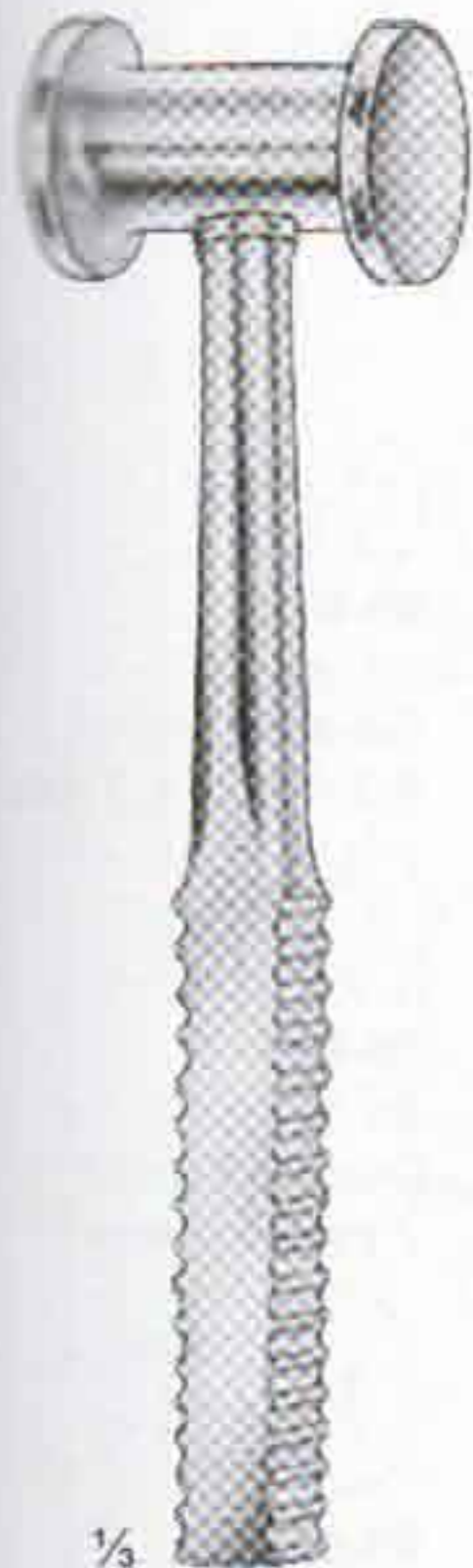

**BERGMANN**  
**09-770**  
24 cm, 9 1/2"  
(300g)



**GERZOG**  
**09-780**  
18 cm, 7"  
(240g)

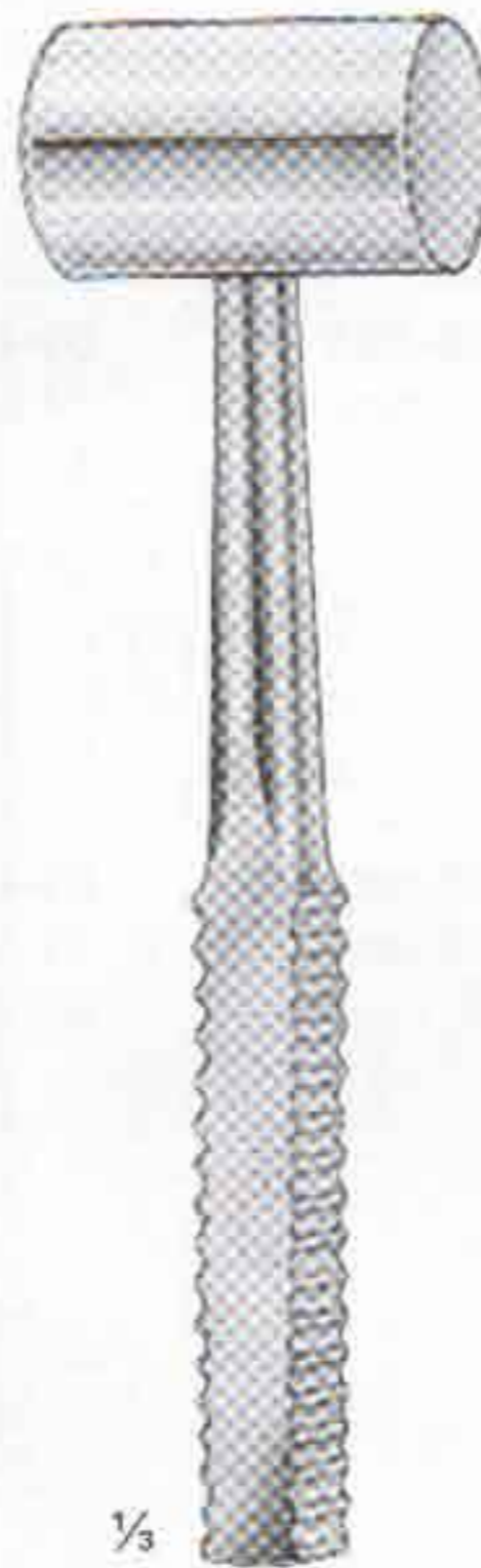

**OMBREDANNE**  
**09-790**  
24 cm, 9 1/2"  
40 mm dia (550g)



**COTTLE**  
**09-800**  
19 cm, 7 1/2"  
(240g)



**COLLIN**  
**09-810**  
20 cm, 8"  
30 mm dia  
220 g

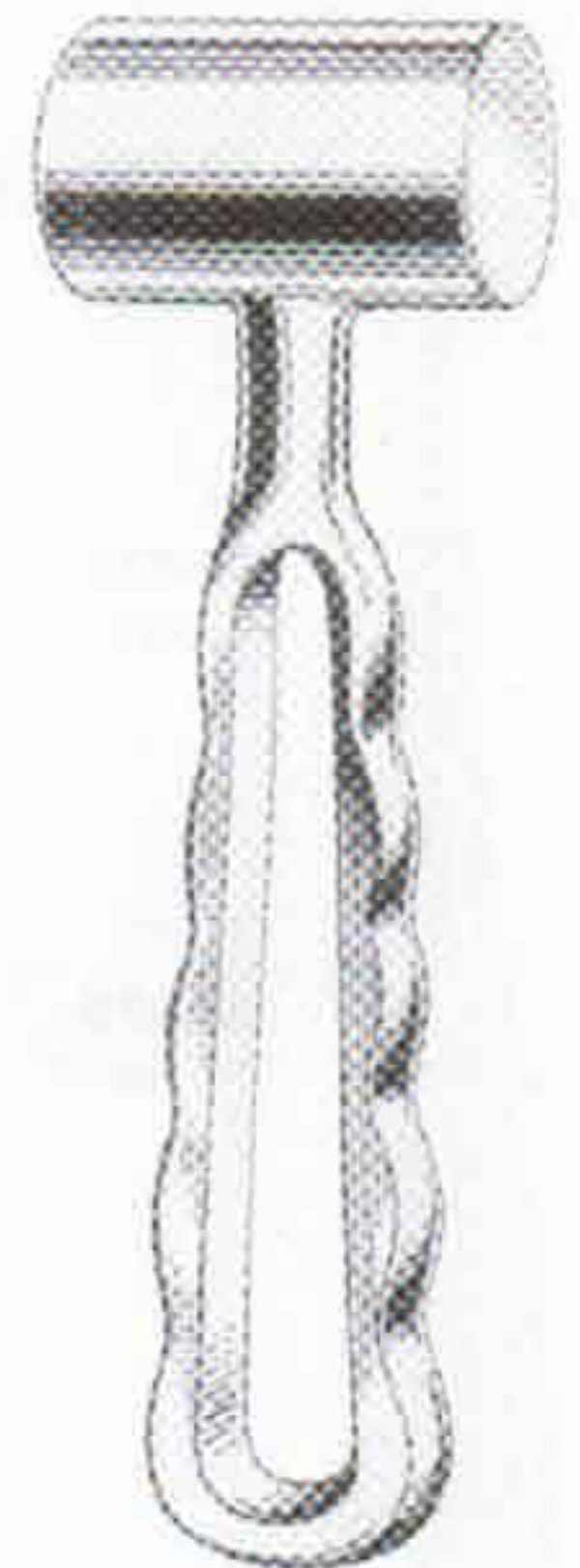

**HEATH**  
**09-820**  
16 cm  
Head 4.5 cm Dia.  
Weight 793 Gr.



# BONE CURETTES

Scharfe Löffel  
Cucharillas cortantes

Curettes tranchantes  
Curette taglianti



- 09-830  
17 cm, 7"  
000
- 09-831  
17 cm, 7"  
00
- 09-832  
17 cm, 7"  
0
- 09-833  
17 cm, 7"  
1
- 09-834  
17 cm, 7"  
2
- 09-835  
17 cm, 7"  
3
- 09-836  
17 cm, 7"  
4
- 09-837  
17 cm, 7"  
5
- 1/4 09-838  
17 cm, 7"  
6

**BRUNS**



- 09-840  
22.5 cm, 9"  
000
- 09-841  
22.5 cm, 9"  
00
- 09-842  
22.5 cm, 9"  
0
- 09-843  
22.5 cm, 9"  
1
- 09-844  
22.5 cm, 9"  
2
- 09-845  
22.5 cm, 9"  
3
- 09-846  
22.5 cm, 9"  
4
- 09-847  
22.5 cm, 9"  
5
- 1/4 09-848  
22.5 cm, 9"  
6

**HIBBS-SPRRATT / ANGLED**



- 09-850  
22.5 cm, 9"  
000
- 09-851  
22.5 cm, 9"  
00
- 09-852  
22.5 cm, 9"  
0
- 09-853  
22.5 cm, 9"  
1
- 09-854  
22.5 cm, 9"  
2
- 09-855  
22.5 cm, 9"  
3
- 09-856  
22.5 cm, 9"  
4
- 09-857  
22.5 cm, 9"  
5
- 1/4 09-858  
22.5 cm, 9"  
6

**HIBBS-SPRRATT / STRAIGHT**



**WILLIGER 09-860**  
13.25 cm, 5 1/2"  
Double Ended  
00/0



- 09-870  
17 cm, 7"  
00000
- 09-871  
17 cm, 7"  
0000
- 09-872  
17 cm, 7"  
000
- 09-873  
17 cm, 7"  
00
- 09-874  
17 cm, 7"  
0
- 09-875  
17 cm, 7"  
1
- 09-876  
17 cm, 7"  
2
- 09-877  
17 cm, 7"  
3
- 09-878  
17 cm, 7"  
4
- 1/4 09-879  
17 cm, 7"  
5

**SPRATT / HOLLOW HANDLE**



- 09-890  
17 cm, 7"  
0000
- 09-891  
17 cm, 7"  
000
- 09-892  
17 cm, 7"  
00
- 09-893  
17 cm, 7"  
0
- 09-894  
17 cm, 7"  
1
- 09-895  
17 cm, 7"  
2
- 09-896  
17 cm, 7"  
3
- 09-897  
17 cm, 7"  
4
- 09-898  
17 cm, 7"  
5
- 1/4 09-899  
17 cm, 7"  
6

**VOLKMANN**



- ↑ ↓ 09-910  
13 cm, 5"  
Double Ended  
6.2 mm & 6.7 mm
- ↑ ↓ 09-911  
16 cm, 6 1/2"  
Double Ended  
7 mm & 9 mm
- ↑ ↓ 09-912  
20 cm, 8"  
Double Ended  
9.1 mm & 11.1 mm

**VOLKMANN**



# BONE CURETTES

Scharfe Löffel  
Cucharillas cortantes

Curettes tranchantes  
Curette taglianti

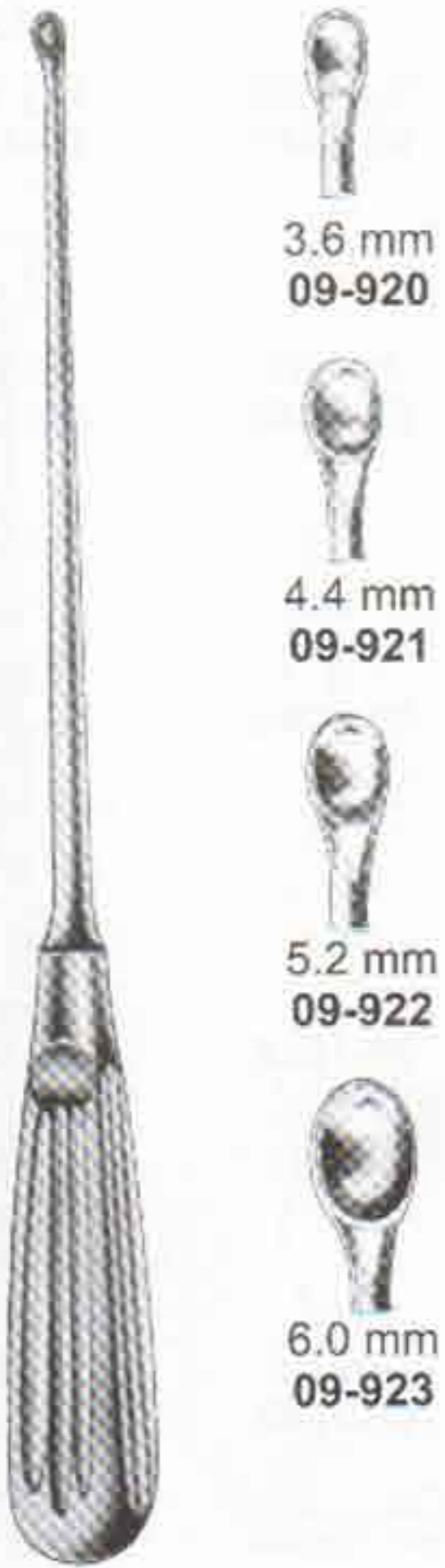

3.6 mm  
09-920

4.4 mm  
09-921

5.2 mm  
09-922

6.0 mm  
09-923

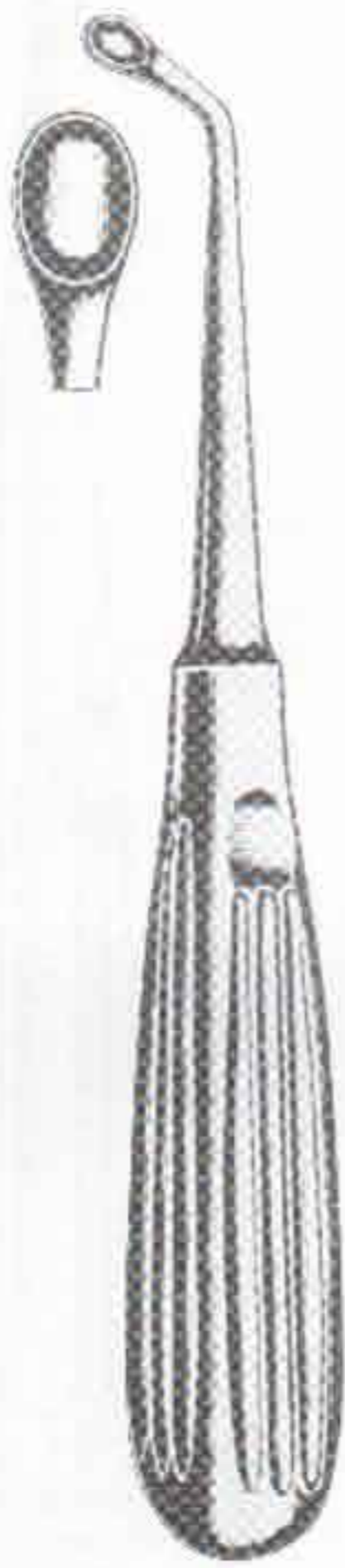

**UFFENORDE Left**  
09-930  
17.5 cm, 7"



**UFFENORDE Right**  
09-940  
17.5 cm, 7"



**SIMON**  
24 cm, 9 1/2"

Fig.1  
09-950

Fig.2  
09-951

Fig.3  
09-953

Fig.4  
09-954

Fig.5  
09-955

Fig.6  
09-956



**BRUNS**  
23 mm, 9"

Fig.1  
09-960

Fig.2  
09-961

Fig.3  
09-962

Fig.4  
09-963

Fig.5  
09-964

Fig.6  
09-965

Fig.7  
09-966

Fig.8  
09-967

Fig.9  
09-968



**WILLIGER**  
13.5 cm, 5 1/4"

09-970

09-971

09-972



**MARTINI**  
13.5 cm, 5 1/4"

09-980

09-981

09-982



**JANSEN**  
09-990  
16 cm, 6 1/4"



**JANSEN**  
09-1000  
15 cm, 6"



# BONE CURETTES, DOUBLE-ENDED

Scharfe Doppellöffel  
Cucharillas de doble extremo

Curettes doubles  
Curette doppia



**09-1010**  
21 cm, 8 1/4"



**VOLKMANN**

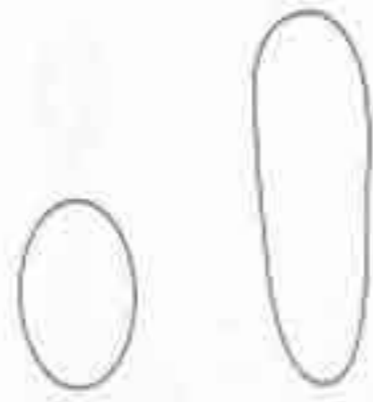

**09-1020**  
13 cm, 5 1/4"

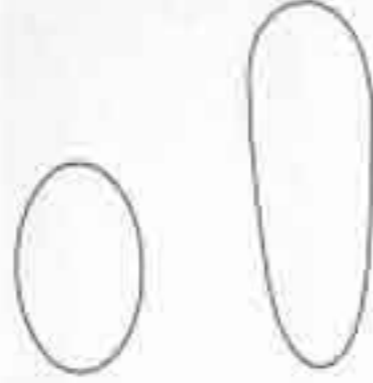

**09-1021**  
14 cm, 5 1/4"

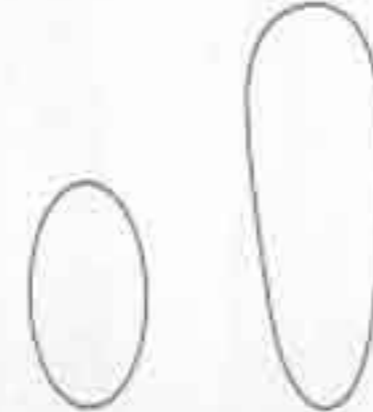

**09-1022**  
17 cm, 6 3/4"



**VOLKMANN**



**09-1030**  
13 cm, 5 1/4"

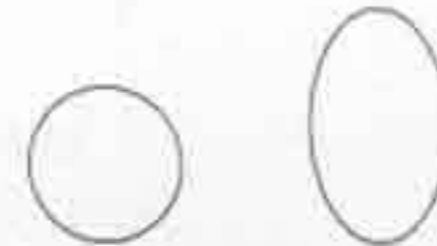

**09-1031**  
16 cm, 6 1/4"

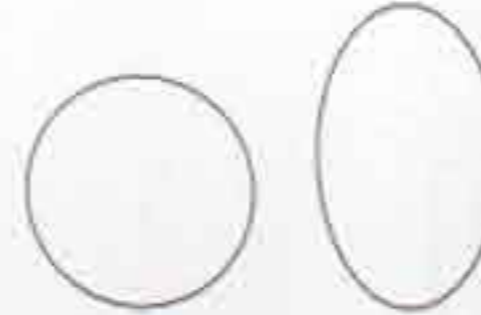

**09-1032**  
20 cm, 8"



**SPRATT**

0  
Fig. 0000  
09-1040

0  
Fig. 00  
09-1042

0  
Fig. 1  
09-1044

0  
Fig. 3  
09-1046

0  
Fig. 5  
09-1048

0  
Fig. 000  
09-1041

0  
Fig. 0  
09-1043

0  
Fig. 2  
09-1045

0  
Fig. 4  
09-1047



**BRUNS**

Fig. 0000  
09-1050

Fig. 0  
09-1053

Fig. 3  
09-1056

Fig. 000  
09-1051

Fig. 1  
09-1054

Fig. 4  
09-1057

Fig. 00  
09-1052

Fig. 2  
09-1055

Fig. 5  
09-1058

Fig. 6  
09-1059



**FIBER HANDLE**  
27 cm, 10 3/4"

Fig. 0  
09-1070

Fig. 1  
09-1071

Fig. 2  
09-1072

Fig. 3  
09-1073



**SCOVILLE**  
25 cm, 10"



**09-1080**  
Straight

**09-1081**  
Down Angle

**09-1083**  
Up Angle



# REAMER, ELEVATORS, BONE FILES & ALVEOTOMY FILES

Reibahlen, Elevatorien, Knochenfeilen, Alveotomiefeilen

Pointes-carrées, Élévateurs, Limes à os, Limes pour alvéolotomie

Escariadores, Elevadores, Limas para huesos, Limas para alveolotomía

Punteruoli, Elevatori, Lime per ossa, Lime per alveolotomia

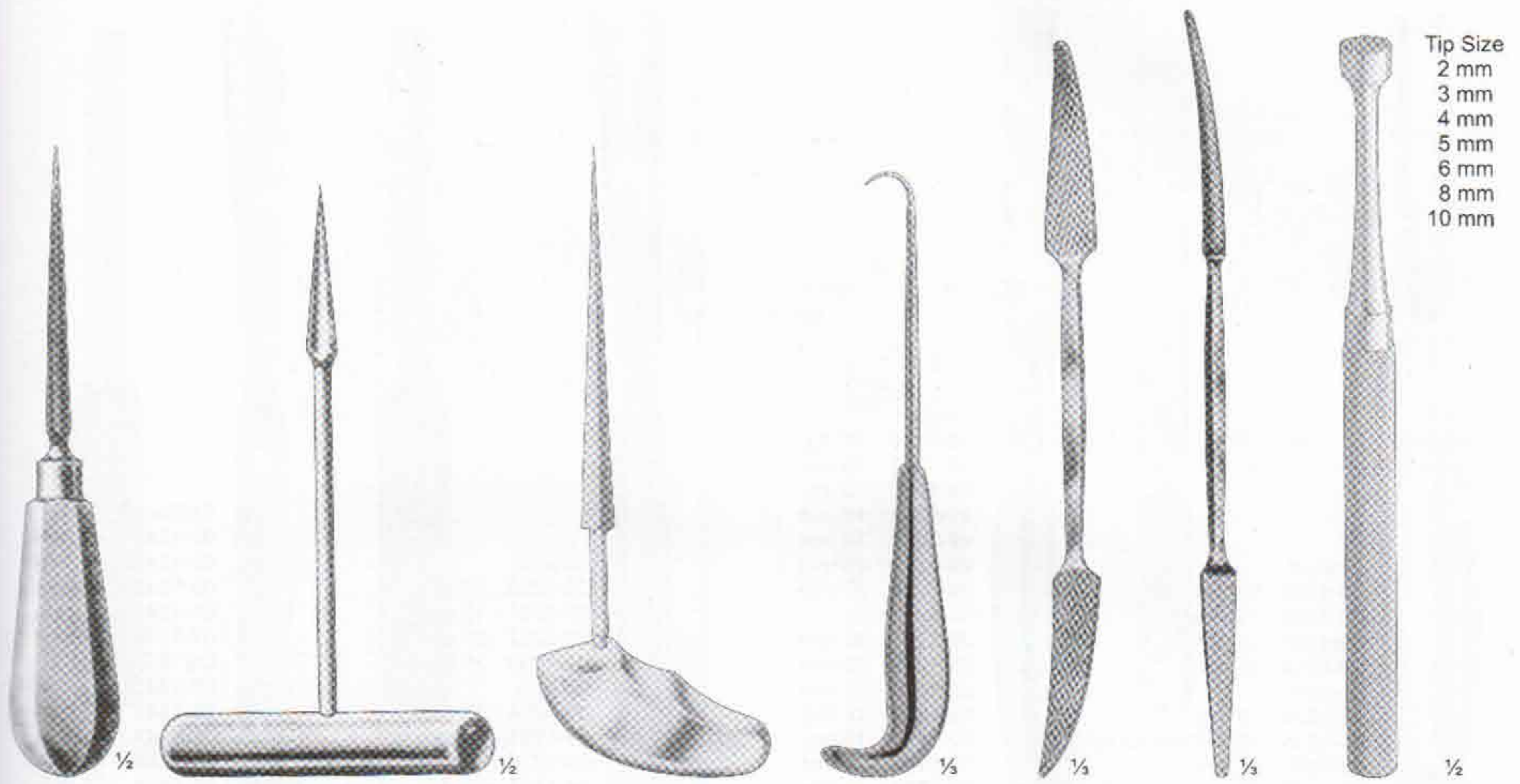

Tip Size  
2 mm  
3 mm  
4 mm  
5 mm  
6 mm  
8 mm  
10 mm

09-1090  
14 cm, 5 1/2"

09-1100  
14 cm, 5 1/2"

**PERTHES**  
09-1110 16 cm, 6 1/2"  
09-1111 22 cm, 8 3/4"

**BONE HOOK**  
09-1120  
23 cm, 9"  
3 cm Dia.

**PUTTI**  
09-1130  
27 cm, 10 1/2"

**PUTTI**  
09-1140  
30 cm, 12"

**BONE TAMPS**  
09-1150  
15.4 cm, 6"



**FOMAN RASP**  
09-1160  
21 cm, 8 1/2"



**MILLER-COLBURN  
BONE FILE**  
09-1170  
18 cm, 7"



Fig. 1  
09-1171



Fig. 2  
09-1172

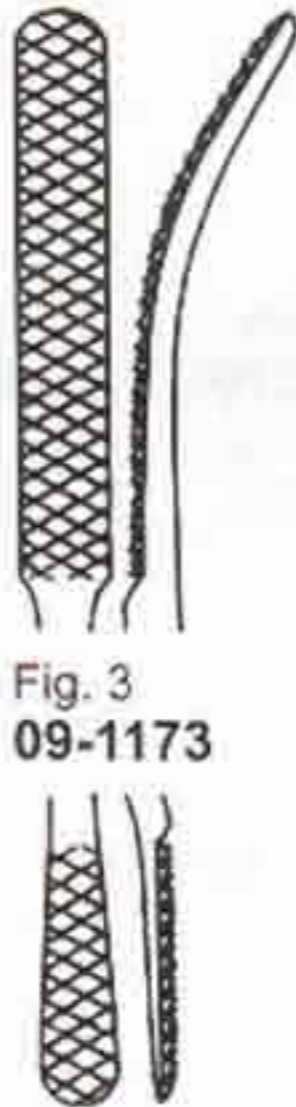
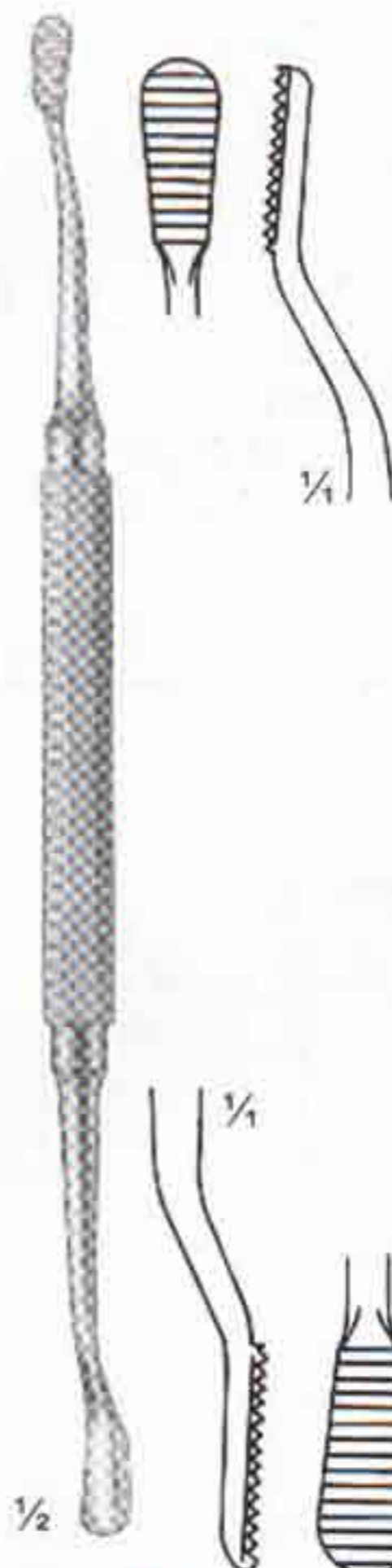

Fig. 3  
09-1173



Fig. 4  
09-1174



**MILLER  
ALVEOTOMY FILE**  
09-1180  
19 cm, 7 1/2"

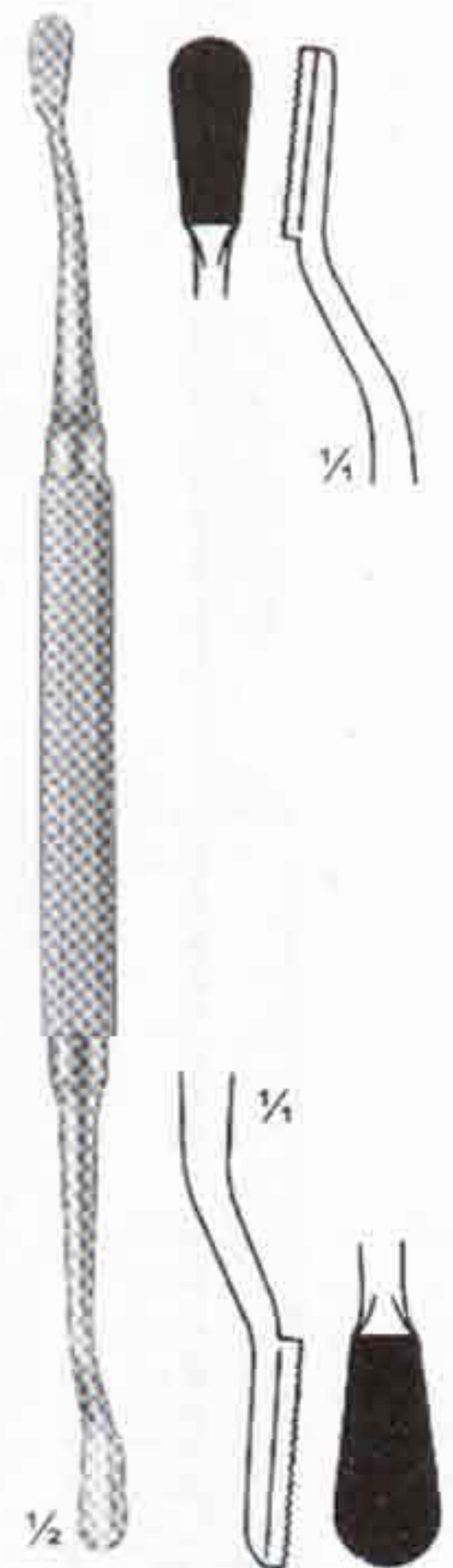

**MILLER  
ALVEOTOMY FILE**  
09-1190  
19 cm, 7 1/2"



# OSTEOTOMES, GOUGES

Osteotome, Hohlmeißel  
Osteótomos, Gubias

Ostéotomes, Gouges  
Osteotomi, Sgorbie



- |          |       |
|----------|-------|
| Straight |       |
| 09-1200  | 09 mm |
| 09-1201  | 14 mm |
| 09-1202  | 19 mm |
| 09-1203  | 25 mm |
| Curved   |       |
| 09-1204  | 09 mm |
| 09-1205  | 14 mm |
| 09-1206  | 19 mm |
| 09-1207  | 25 mm |

**SMITH PETERSON**  
20 cm, 8"



- |          |       |
|----------|-------|
| Straight |       |
| 09-1210  | 06 mm |
| 09-1211  | 09 mm |
| 09-1212  | 13 mm |
| 09-1213  | 16 mm |
| 09-1214  | 19 mm |
| 09-1215  | 25 mm |
| 09-1216  | 32 mm |
| Curved   |       |
| 09-1217  | 06 mm |
| 09-1218  | 09 mm |
| 09-1219  | 13 mm |
| 09-1220  | 16 mm |
| 09-1221  | 19 mm |
| 09-1222  | 25 mm |
| 09-1223  | 32 mm |

**SMITH PETERSON**  
20 cm, 8"



- |          |       |
|----------|-------|
| Straight |       |
| 09-1230  | 10 mm |
| 09-1231  | 15 mm |
| 09-1232  | 20 mm |
| 09-1233  | 25 mm |
| Curved   |       |
| 09-1234  | 10 mm |
| 09-1235  | 15 mm |
| 09-1236  | 20 mm |
| 09-1237  | 25 mm |

**STILLE**  
20 cm, 8"



- |                  |       |
|------------------|-------|
| <b>CHISELS</b>   |       |
| 09-1240          | 10 mm |
| 09-1241          | 12 mm |
| 09-1242          | 15 mm |
| 09-1243          | 20 mm |
| 09-1244          | 25 mm |
| <b>OSTEOTOME</b> |       |
| 09-1245          | 10 mm |
| 09-1246          | 12 mm |
| 09-1247          | 15 mm |
| 09-1248          | 20 mm |
| 09-1249          | 25 mm |

**STILLE**  
20 cm, 8"

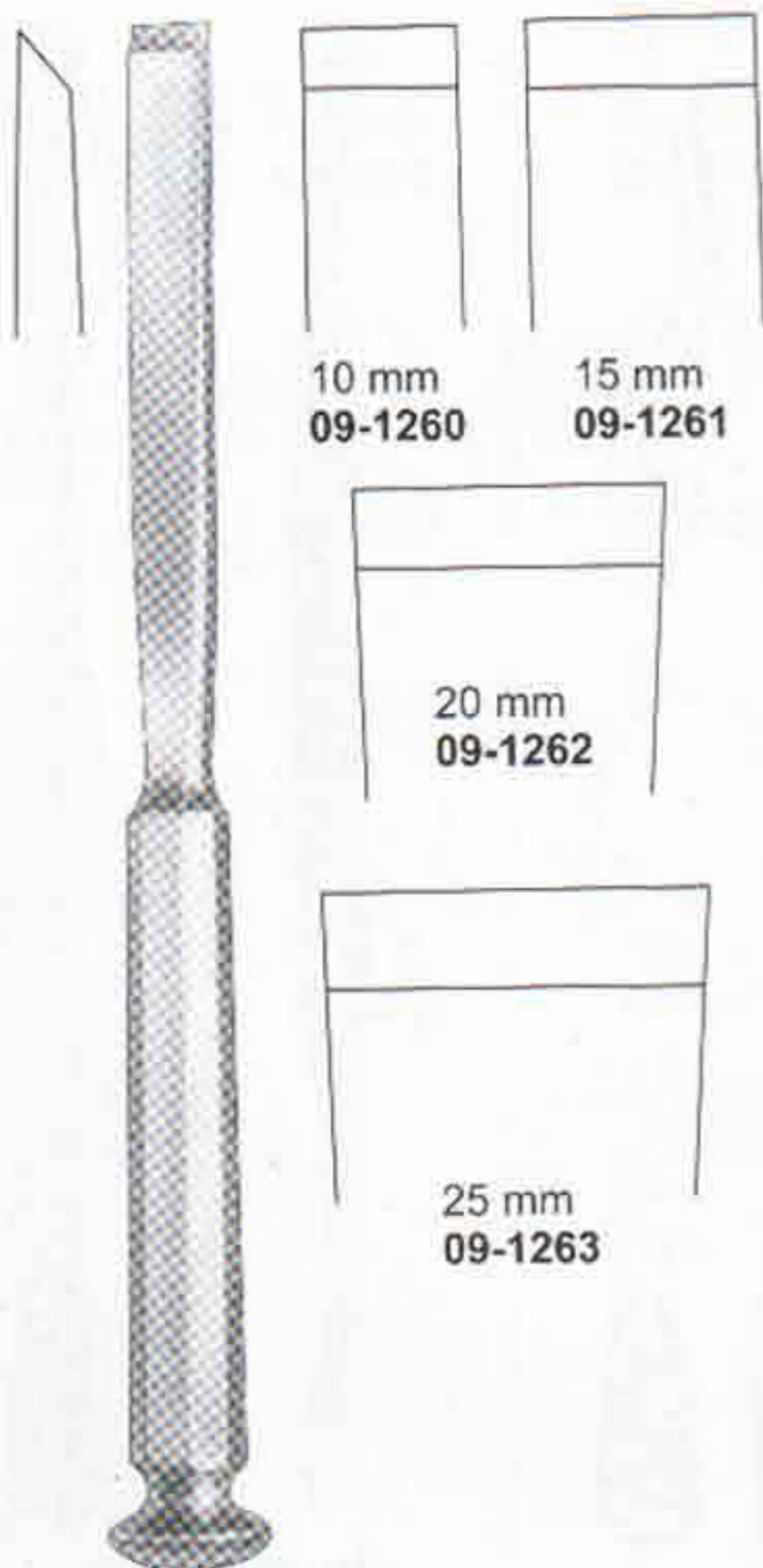

**STILLE**  
09-1260 – 09-1263  
20 cm, 8"

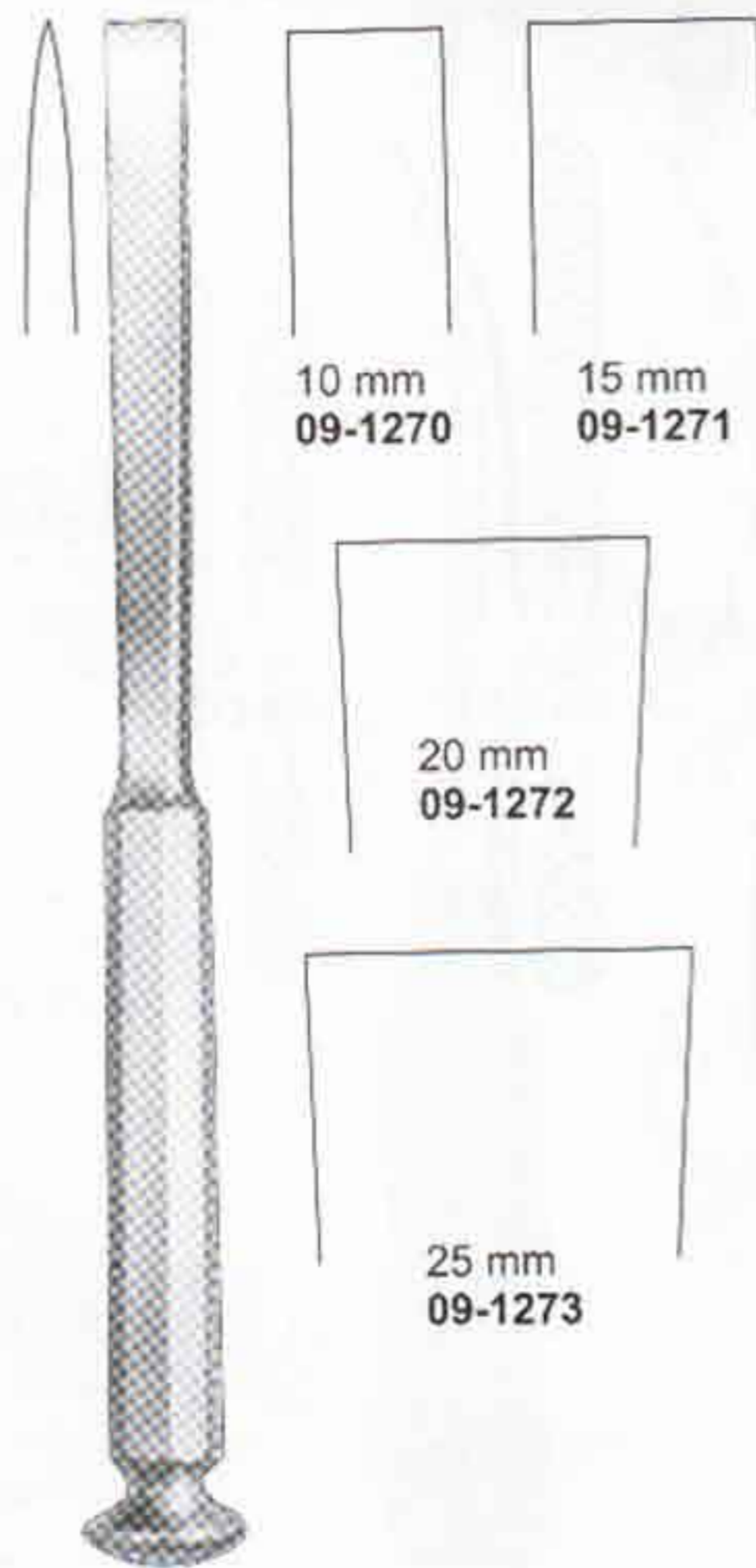

09-1270 – 09-1273  
20 cm, 8"



**PARTSCH**

- |         |         |
|---------|---------|
| 2 mm    | 2 mm    |
| 09-1280 | 09-1281 |
| 135 mm  | 170 mm  |
| 3 mm    | 3 mm    |
| 09-1282 | 09-1283 |
| 135 mm  | 170 mm  |
| 4 mm    | 4 mm    |
| 09-1284 | 09-1285 |
| 135 mm  | 170 mm  |
| 5 mm    | 5 mm    |
| 09-1286 | 09-1287 |
| 135 mm  | 170 mm  |
| 6 mm    | 6 mm    |
| 09-1288 | 09-1289 |
| 135 mm  | 170 mm  |



# OSTEOTOMES, GOUGES

Osteotome, Hohlmeißel  
Osteótomos, Gubias

Ostéotomes, Gouges  
Osteotomi, Sgorbie



**09-1300** Straight 5 mm  
**09-1301** 10 mm  
**09-1302** 15 mm



**09-1310** Curved 5 mm  
**09-1311** 10 mm  
**09-1312** 15 mm



**MINI-LAMBOTTE**  
12.5 cm, 5"

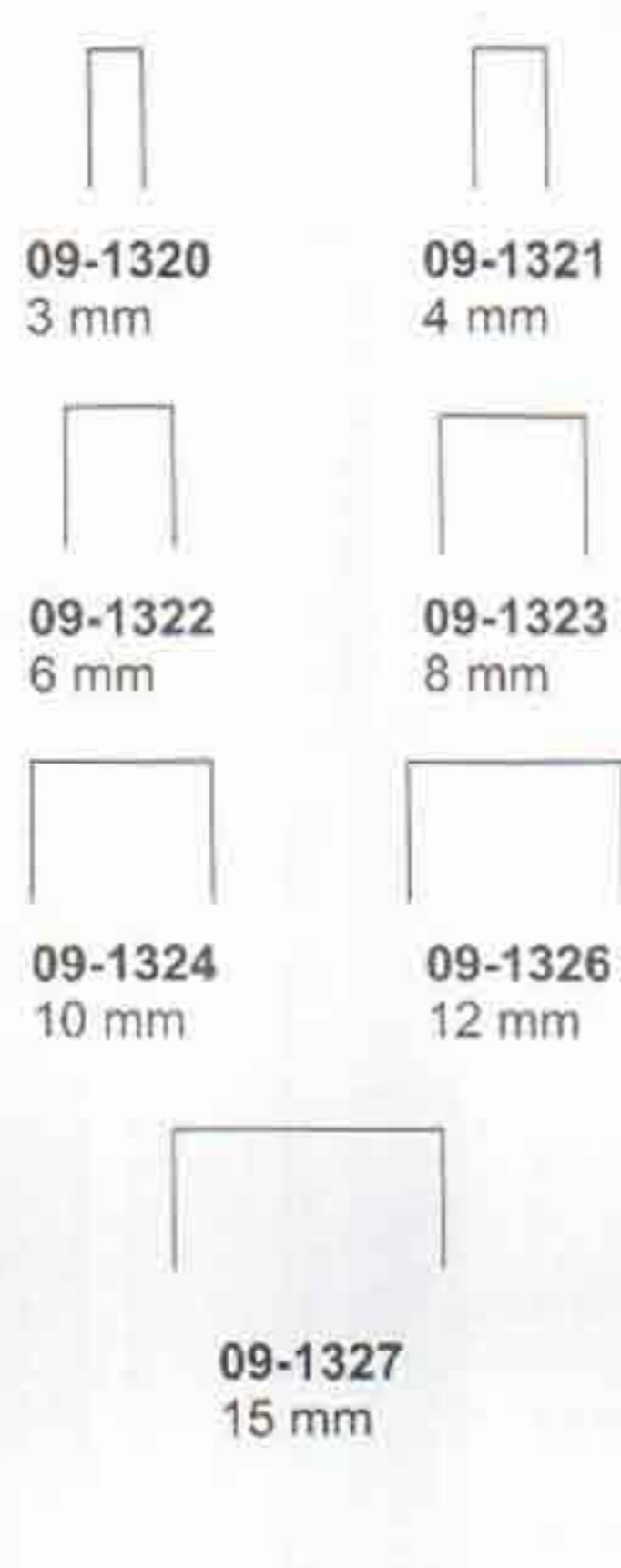

**09-1320** 3 mm  
**09-1321** 4 mm  
**09-1322** 6 mm  
**09-1323** 8 mm  
**09-1324** 10 mm  
**09-1326** 12 mm



**09-1327**  
15 mm



**MINI LAMBOTTE**  
17 cm, 6 3/4"

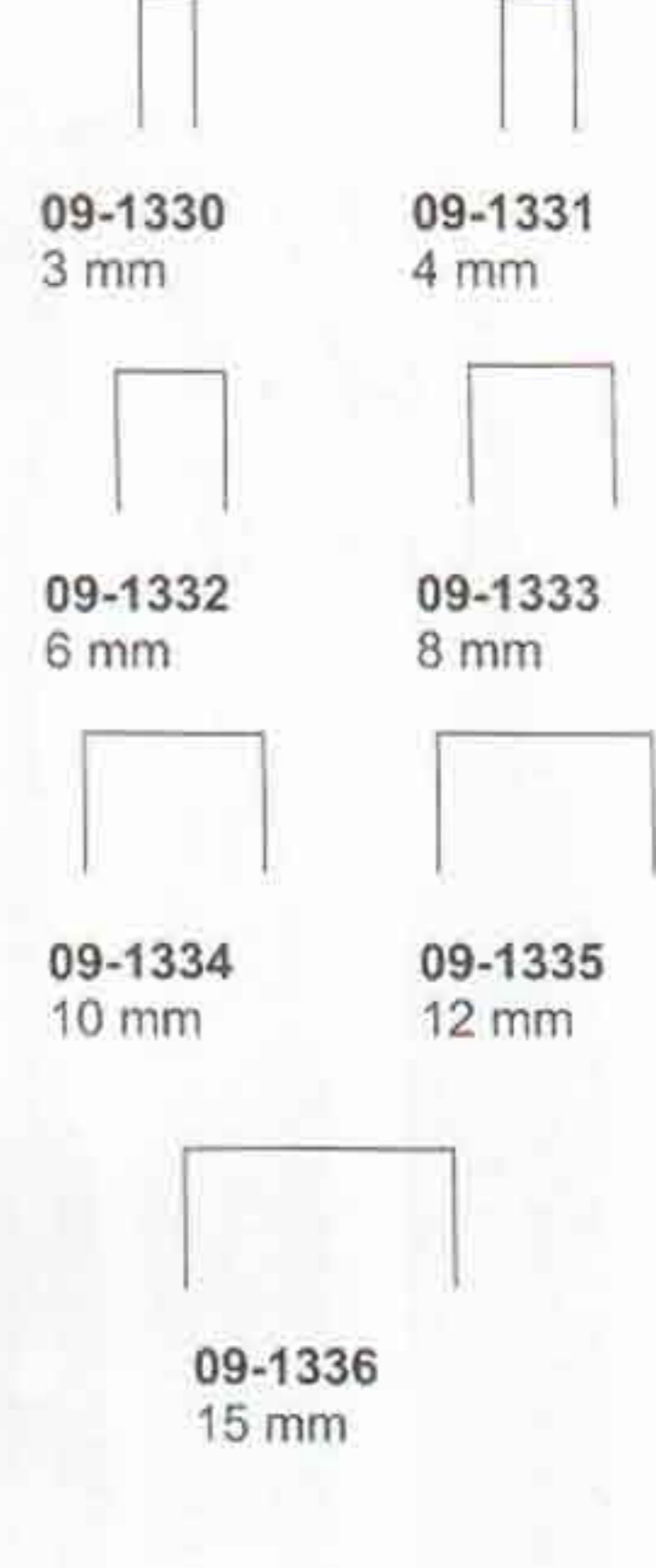

**09-1330** 3 mm  
**09-1331** 4 mm  
**09-1332** 6 mm  
**09-1333** 8 mm  
**09-1334** 10 mm  
**09-1335** 12 mm



**09-1336**  
15 mm



**ALEXANDER**

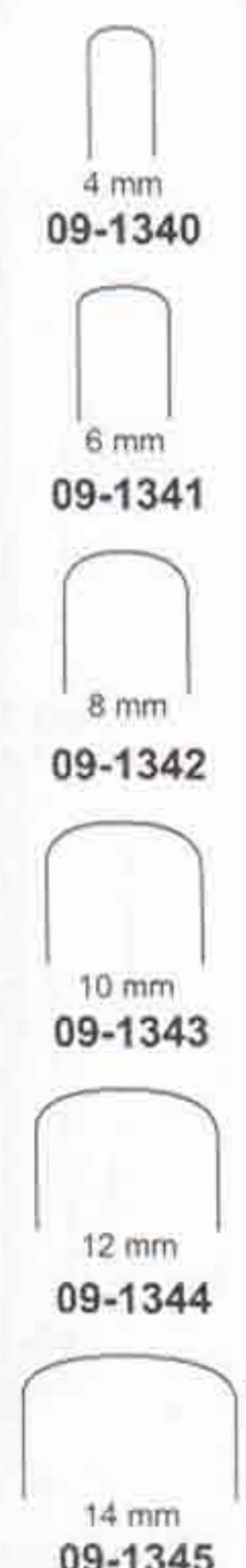

**09-1340** 4 mm  
**09-1341** 6 mm  
**09-1342** 8 mm  
**09-1343** 10 mm  
**09-1344** 12 mm  
**09-1345** 14 mm



**LAMBOTTE**  
24 cm, 9 1/2"

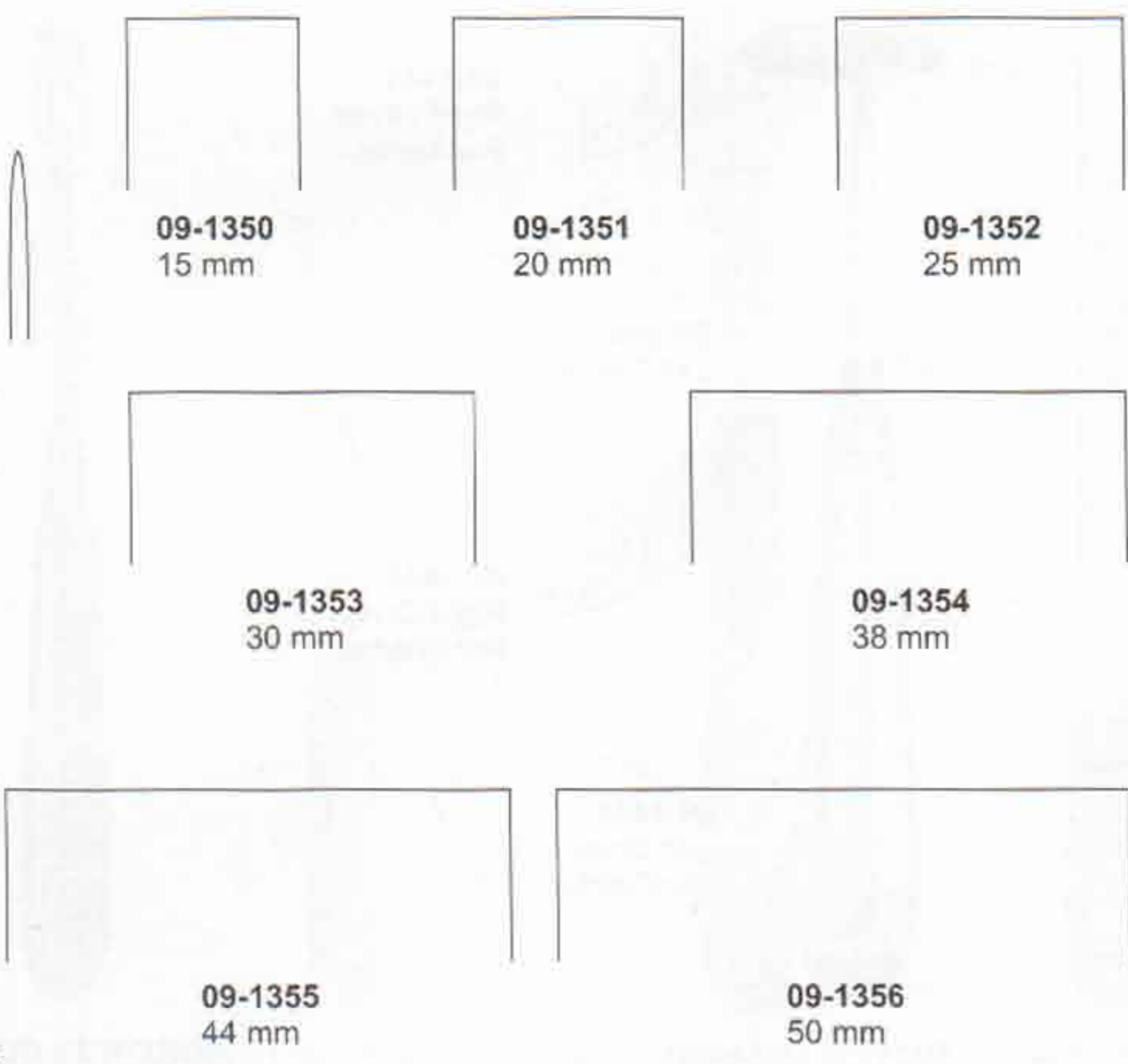

**09-1350** 15 mm  
**09-1351** 20 mm  
**09-1352** 25 mm  
**09-1353** 30 mm  
**09-1354** 38 mm  
**09-1355** 44 mm  
**09-1356** 50 mm



**LAMBOTTE**  
23 cm, 9"

**09-1360** 15 mm  
**09-1361** 20 mm  
**09-1362** 25 mm  
**09-1363** 30 mm  
**09-1364** 38 mm  
**09-1365** 44 mm  
**09-1366** 50 mm





# PERIOSTEAL ELEVATORS

Raspatorien  
Periostótomos

Rugines-raspatoires  
Periostotomi



**PERIOSTEAL Elevator**  
**09-1370**  
18.2 cm, 7"  
Fiber/Phenolic Handle  
blade 6mm



**CHANDLER Bone Elevator**

- 09-1380**  
19 cm, 7 1/2" 13 mm
- 09-1381**  
20 cm, 8" 20 mm
- 09-1382**  
23 cm, 9" 25 mm
- 09-1383**  
25 cm, 10" 31 mm



**HOEN PERIOSTEAL Elevator**  
**09-1390**  
16.5 cm, 6 1/2"



**KEY PERIOSTEAL Elevator**  
**09-1400**  
18 cm, 7 1/2"



**KEY (Fig. A)**

Fig.	Item	Description	Inch.	Width
A	09-1410	19 cm	7 1/2"	3 mm
A	09-1411	19 cm	7 1/2"	6 mm
A	09-1412	19 cm	7 1/2"	9 mm
A	09-1413	19 cm	7 1/2"	12 mm
A	09-1414	19 cm	7 1/2"	15 mm
A	09-1415	19 cm	7 1/2"	19 mm
A	09-1416	19 cm	7 1/2"	25 mm



**COBB Elevators**  
**09-1420**  
23.4 cm, 9"  
Hex Handle



**PERIOSTEAL ELEVATOR**  
**09-1430**  
17 cm, 7"

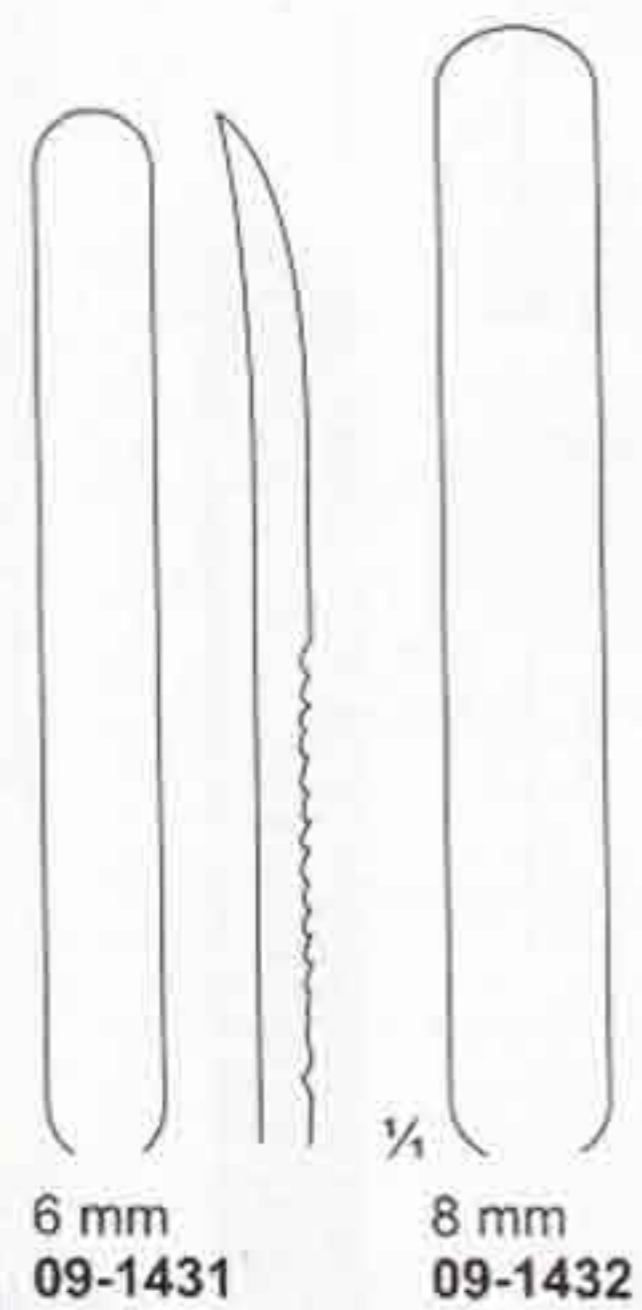

6 mm  
**09-1431**

8 mm  
**09-1432**



**DOYEN RIB RASPATORY**  
**09-1440**  
17 cm, 7"



**09-1441**  
Right Crved  
For Adults

**09-1442**  
Left Crved  
For Adults

**09-1443**  
Right Crved  
For Children

**09-1444**  
Left Crved  
For Children



**ADSON ELEVATOR**  
**09-1450**  
17 cm, 7"

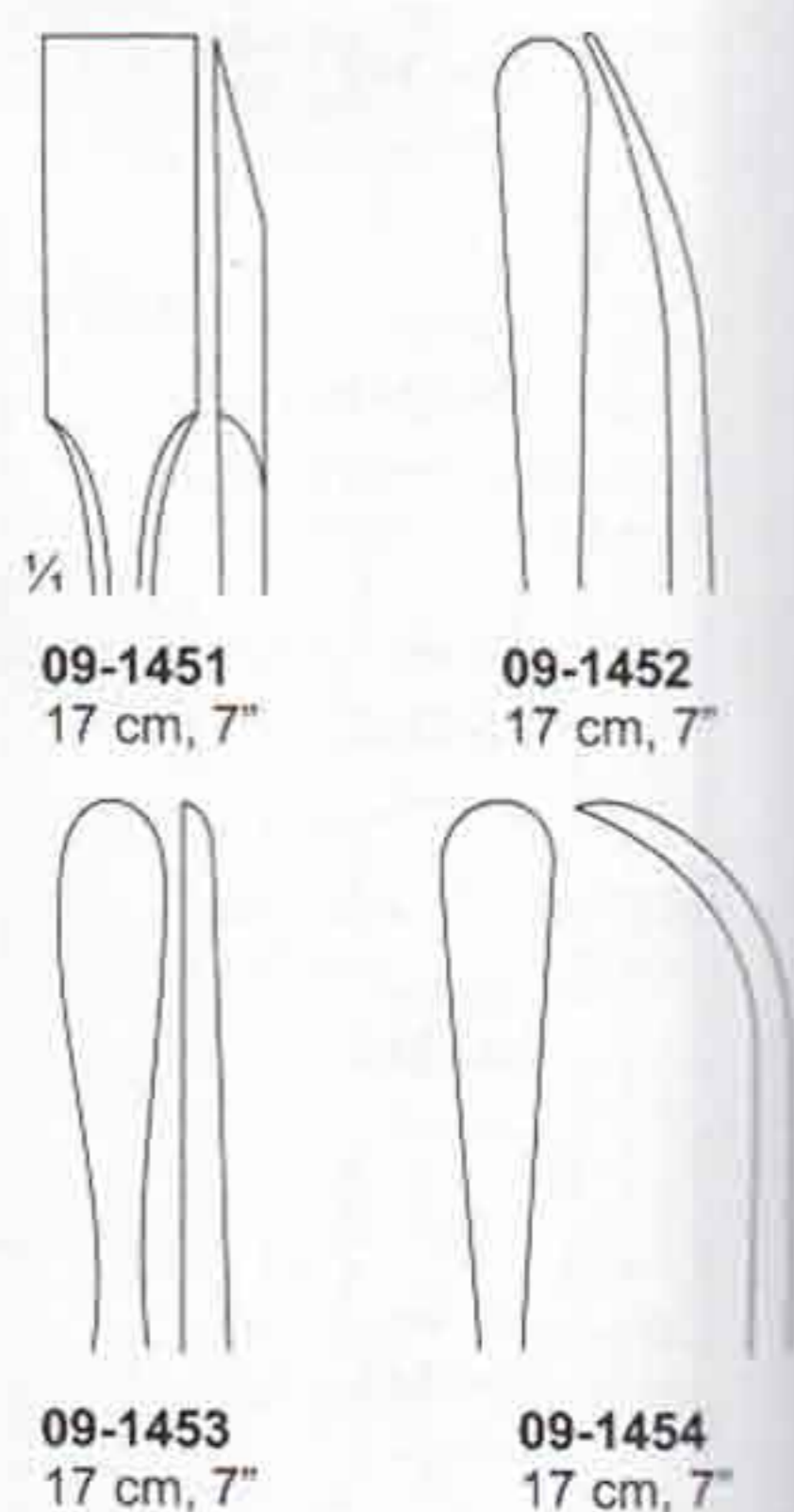

**09-1451**  
17 cm, 7"

**09-1452**  
17 cm, 7"

**09-1453**  
17 cm, 7"

**09-1454**  
17 cm, 7"



# PERIOSTEAL ELEVATORS

Raspatorien  
Periostótomos

Rugines-raspatoires  
Periostotomi

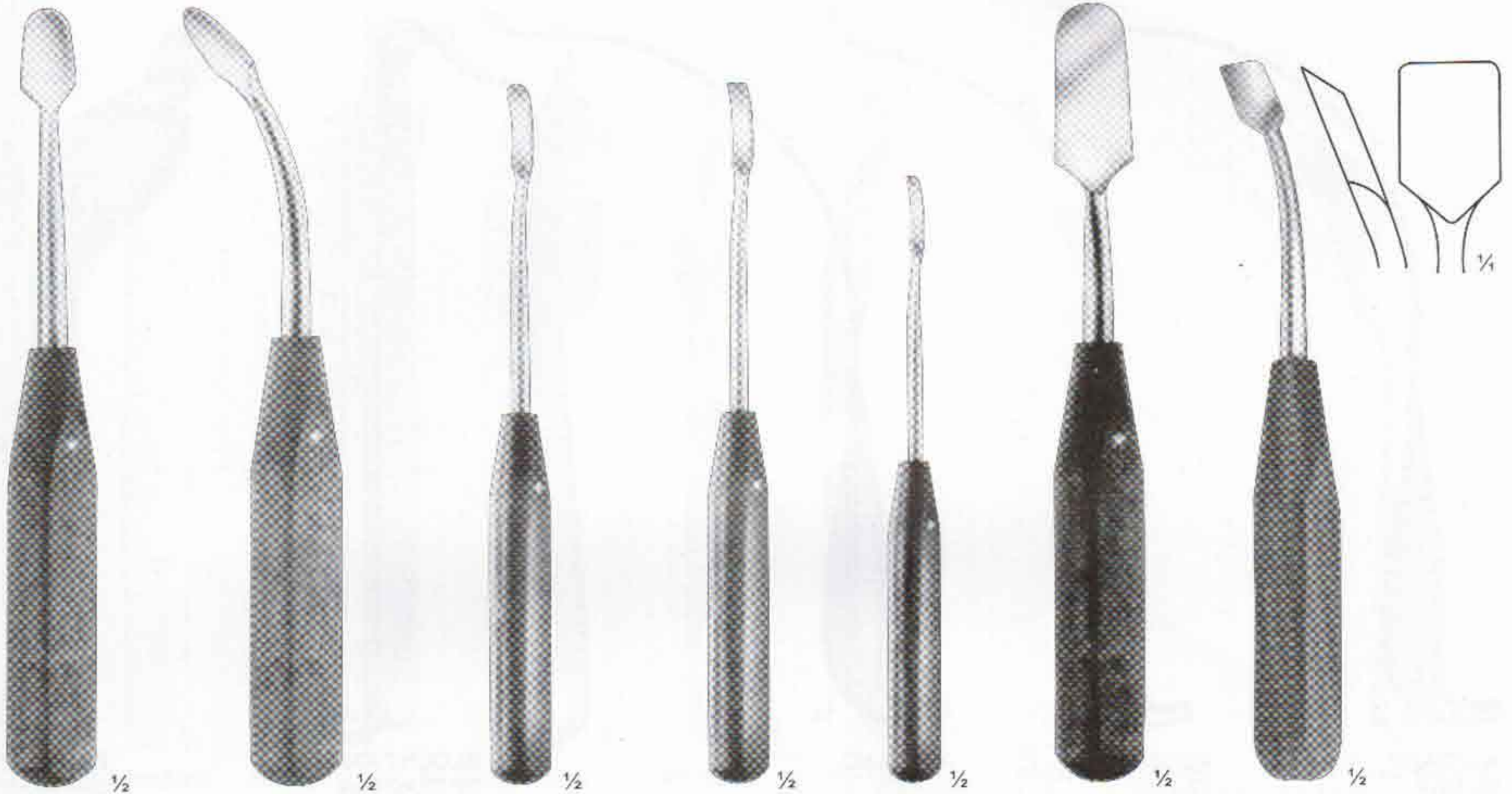

**09-1460**  
20 cm, 8"  
Medium straight  
blade round edge,  
width 14 mm

**09-1470**  
20 cm, 8"  
Medium curved  
blade round edge,  
width 14 mm

**09-1480**  
18 cm, 7"  
Small curved  
blade round edge,  
width 6 mm

**09-1490**  
18 cm, 7"  
Small curved  
blade straight edge,  
width 6 mm

**09-1500**  
18 cm, 7"  
Extra small  
curved blade  
round edge,  
width 3 mm

**09-1510**  
20 cm, 8"  
large straight blade  
round edge,  
width 20 mm

Medium Blade  
Straight Edge, 14 mm  
**09-1520**  
Straight 18.5 cm, 7 1/2"  
**09-1521**  
Curved 18.5 cm, 7 1/2"

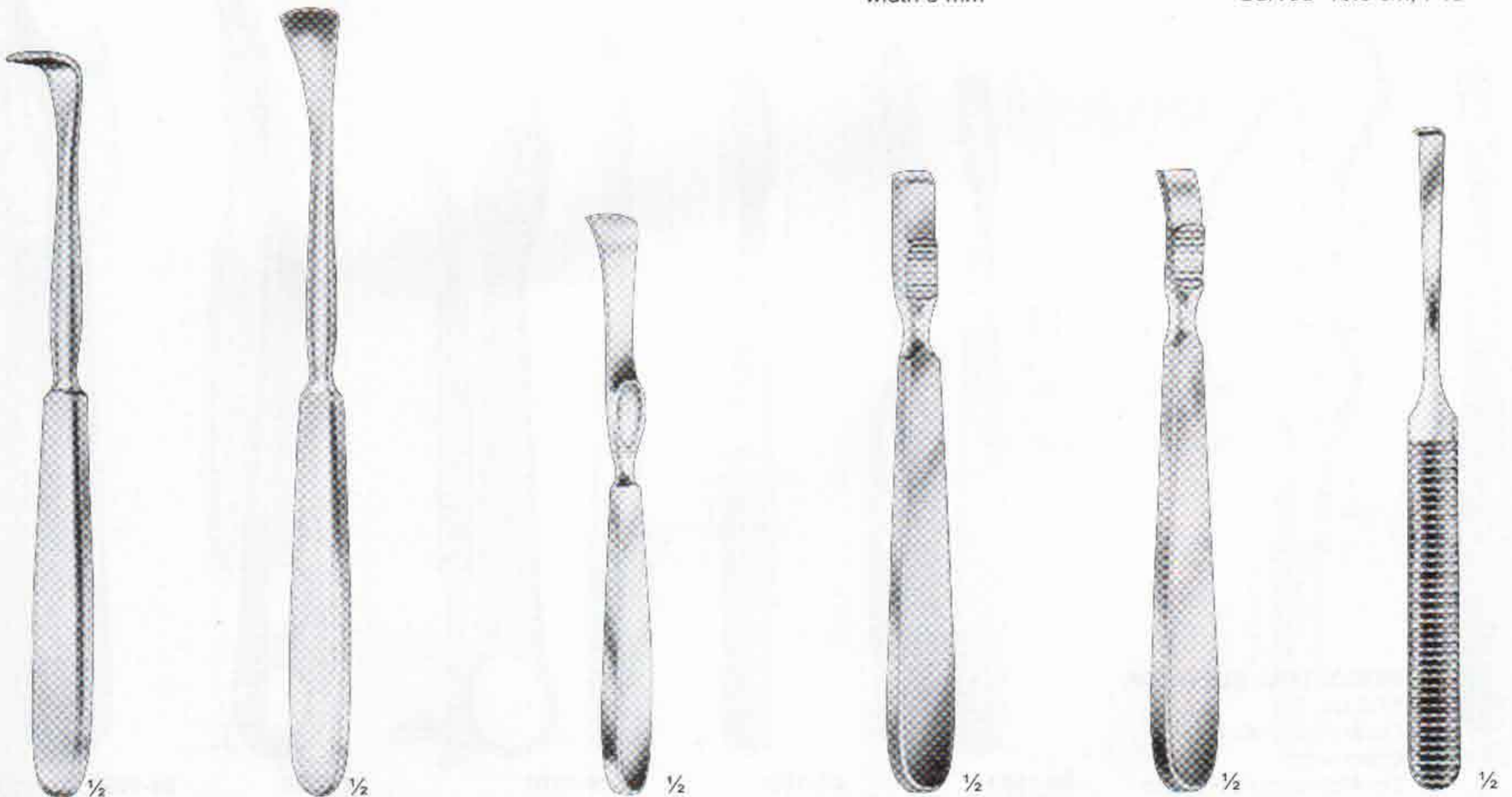

**LANGENBECK**  
**09-1530**  
18 cm, 7"

**LANGENBECK**  
**09-1540**  
19 cm, 7 1/2"

**LAMBOTTE** 21 cm, 8 1/2"  
**09-1550** 1.0 cm  
**09-1551** 1.5 cm  
**09-1552** 2.0 cm

**FARABEUF**  
**09-1560**  
15 cm, 6"

**FARABEUF**  
**09-1570**  
15 cm, 6"

**09-1580** 5 mm  
**09-1581** 6 mm  
**09-1582** 7 mm  
16 cm, 6 1/2"



# BONE LEVERS, KNEE RETRACTORS & SPINAL RETRACTORS

Knochenhebel, Kniehaken, Spinalhaken  
Elevadores para hueso, Separadores para le genou,

Leviers á os, Ecarteurs pour le genou, Ecarteurs spinaux  
Elevatori per ossa, Divaricatori per il ginocchio,

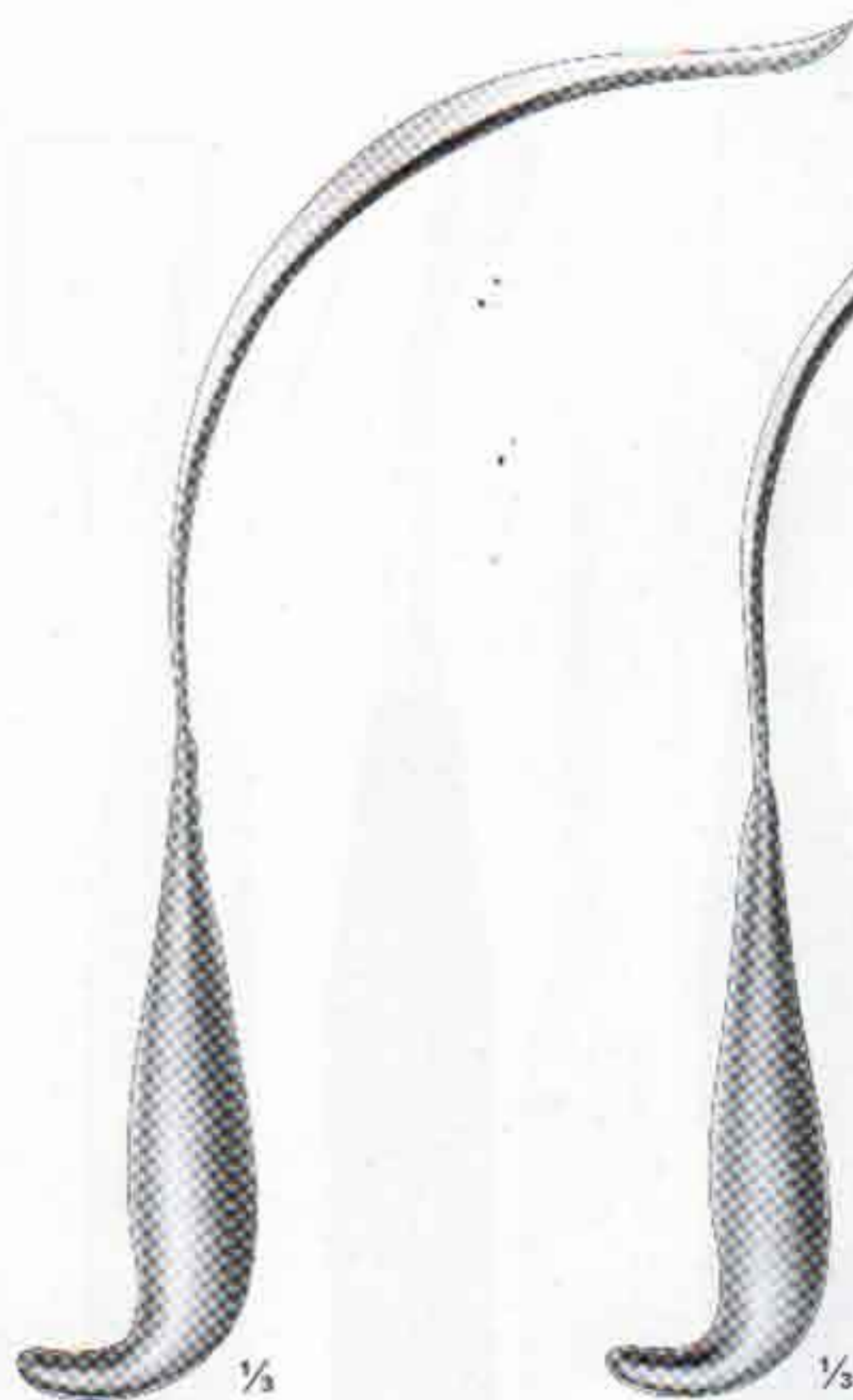

**AUFRANC**  
09-1590  
29 cm, 11 1/2"

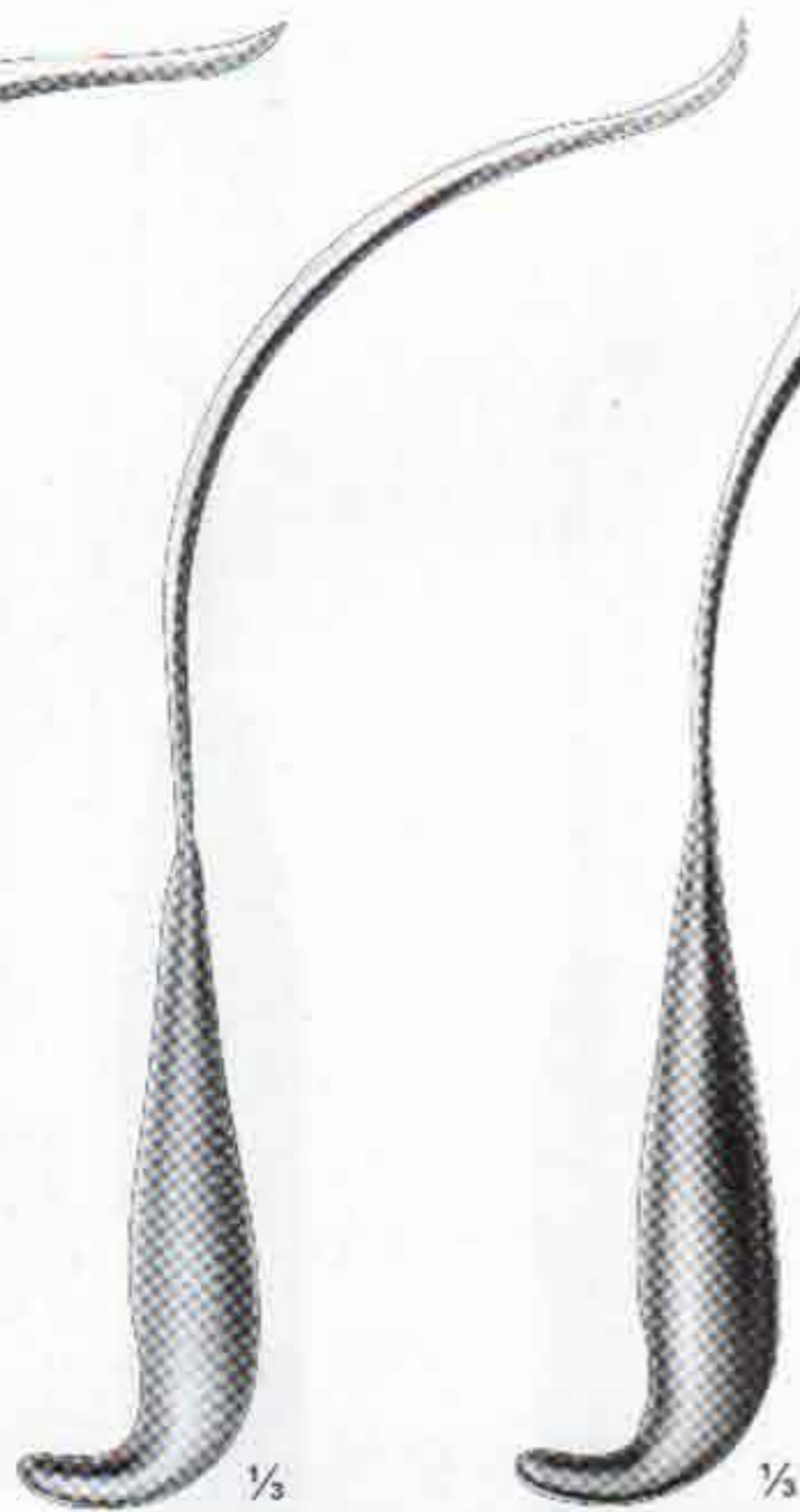

**AUFRANC**  
09-1600  
29 cm, 11 1/2"



**AUFRANC**  
09-1610  
29 cm, 11 1/2"

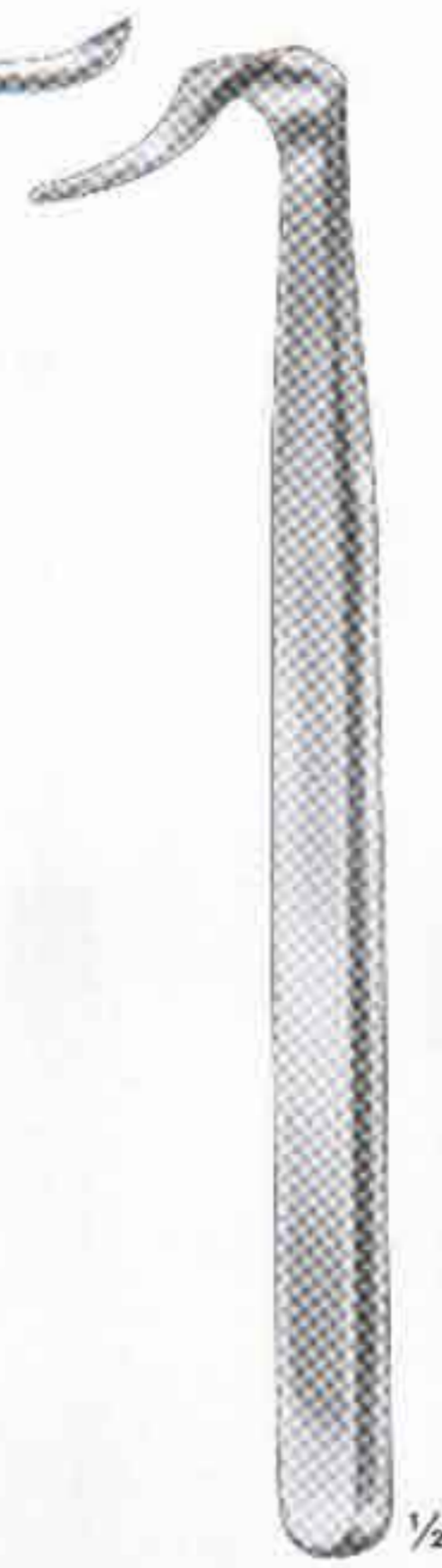

**BLOUNT KNEE  
RETRACTOR**  
09-1620  
17.5 cm, 7"



**BENNETT**  
09-1630  
24 cm, 9 1/2"  
43 mm, 60 mm  
65 mm,

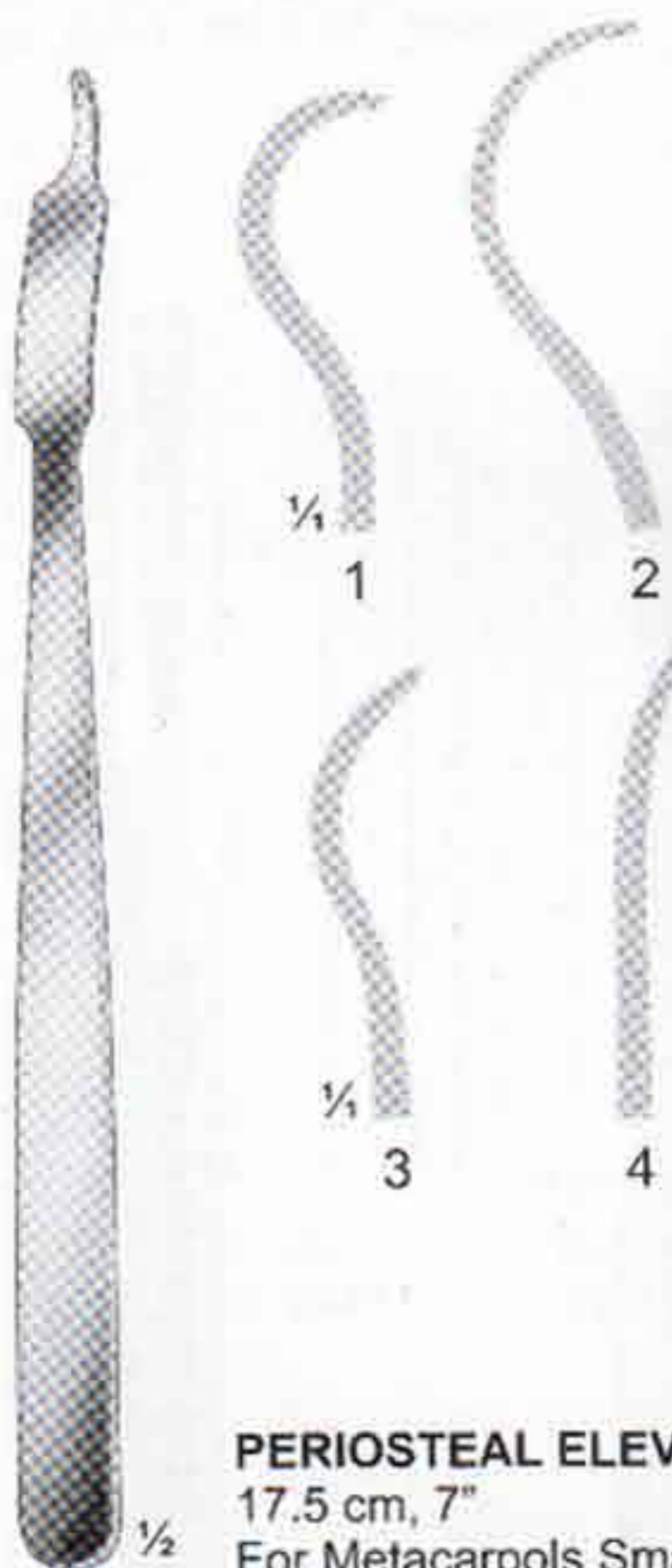

**PERIOSTEAL ELEVATOR**  
17.5 cm, 7"  
For Metacarpals Small  
6 mm width  
09-1641 For Metacarpals Medium  
10 mm width  
09-1642 Light Curve, Rounded End,  
5 mm width  
09-1643 Contra Angled Curve  
4.5 mm width



**09-1650**  
18 cm, 7"  
Small, width 6 mm  
short, narrow tip



**09-1660**  
18 cm, 7"  
Small, width 8 mm  
short, narrow tip



**09-1670**  
12.5 cm, 5"  
For Small Fragments  
Board Shank



**09-1680**  
20 cm, 8"  
Width 8 mm  
short, narrow tip



**09-1690** 20 cm, 8"  
Width 18 mm short,  
narrow tip  
**09-1691** 20 cm, 8"  
Width 18 mm long,  
narrow tip



# BONE LEVERS, KNEE RETRACTORS & SPINAL RETRACTORS

Knochenheber, Kniehaken, Spinalhaken  
Elevadores para hueso, Separadores para le genou,

Leviers á os, Ecarteurs pour le genou, Ecarteurs spinaux  
Elevatori per ossa, Divaricatori per il ginocchio,

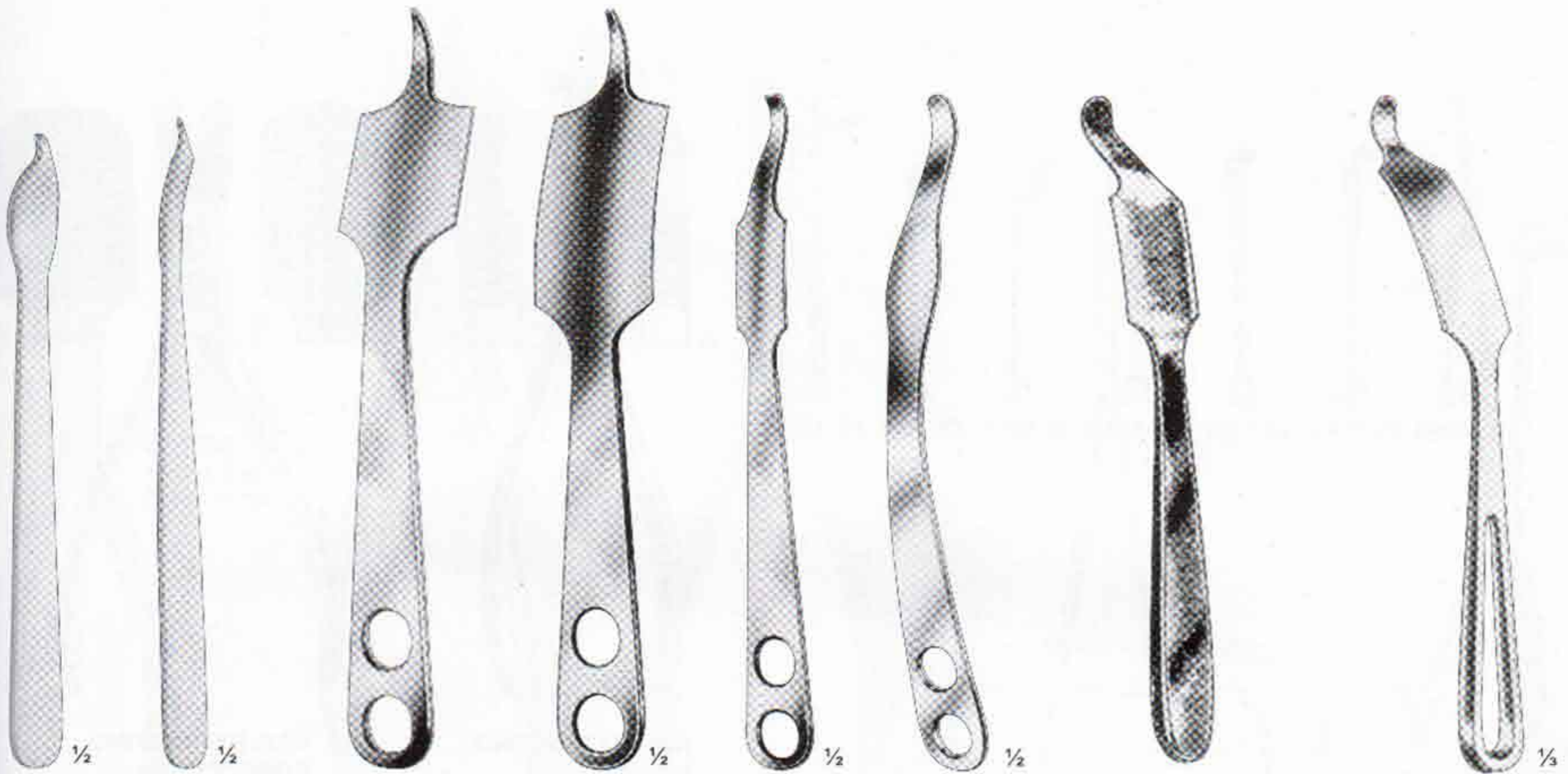

<b>HOHMANN</b> 09-1700 15 cm, 6"	<b>HOHMANN</b> 09-1710 15.4 cm, 6" Short tip	<b>09-1720</b> 18 cm, 7" Width 43 mm narrow tip <b>09-1721</b> 18 cm, 7" Width 70 mm narrow tip	<b>09-1730</b> 18 cm, 7" Width 43 mm long shank, angled	<b>09-1740</b> 16 cm, 6 1/2" width 22 mm wide tip	<b>09-1750</b> 16 cm, 6 1/2" long wire tip for Hip Surgery, width 24 mm	<b>LANGE-HOHMANN</b> 09-1760 27cm 09-1761 29cm	<b>09-1762</b> 09-1763	<b>LANGE-HOHMANN</b> 09-1770 24 cm, 9 1/2" 09-1771 26 cm, 10 1/2" 09-1772 29 cm, 11 1/2"
--	---	--	---	--	---	--	---------------------------	---

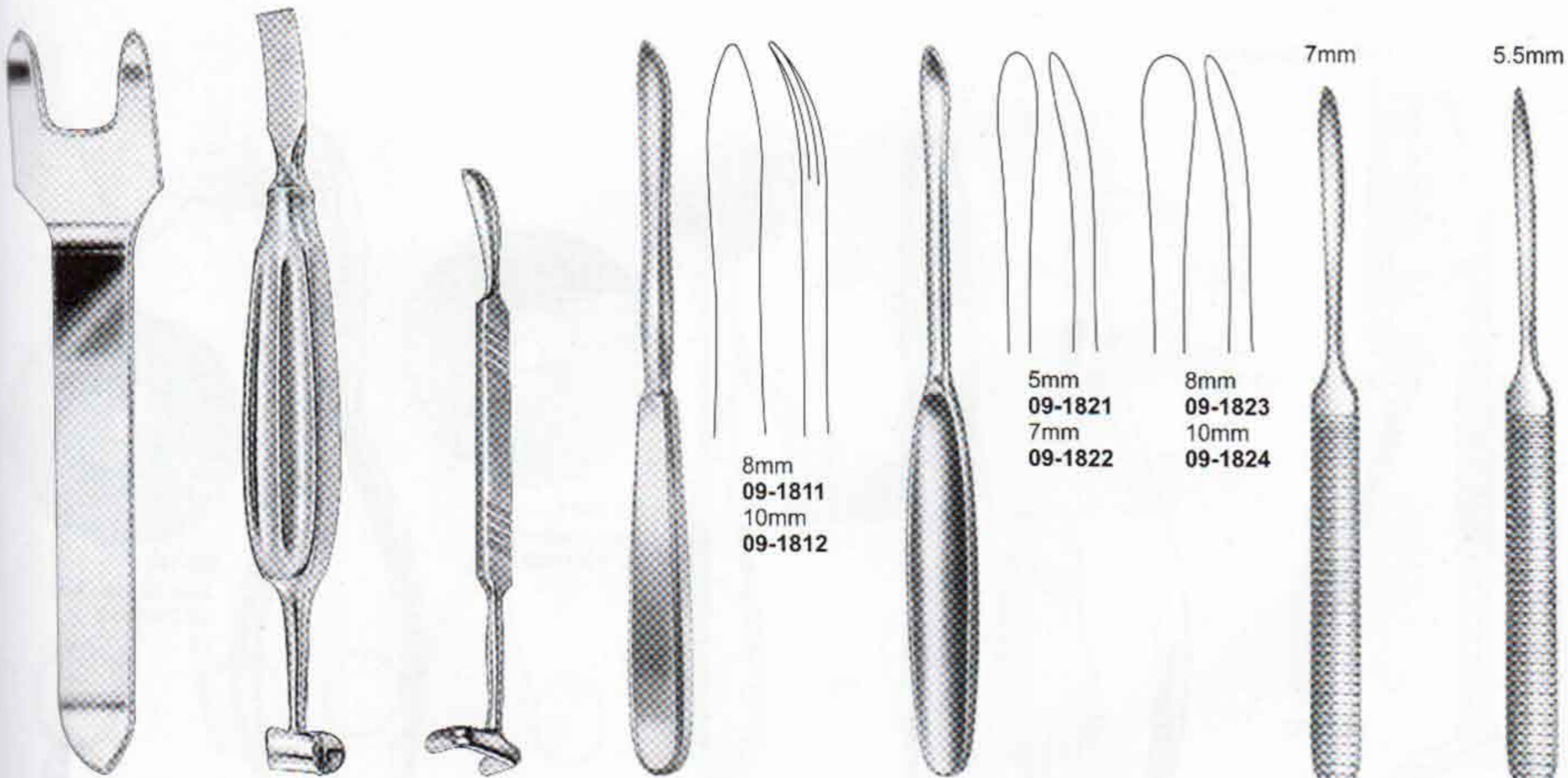

<b>RETRACTOR FOR KNEE</b> 09-1780 27 cm, 11" Blunt	<b>ALEXANDER</b> 09-1790 20 cm, 8"	<b>MATSON</b> 09-1800 22 cm, 9"	<b>LANGENBECK ELEVATOR</b> 09-1810 19.5cm	<b>MARTIN-LANGENBECK ELEVATOR</b> 09-1820 17cm	5mm 09-1821 7mm 09-1822	8mm 09-1823 10mm 09-1824	7mm Williger Elevator 09-1830 17cm	5.5mm Williger Elevator 09-1840 17cm
--	--	---------------------------------------	---	--	----------------------------------	-----------------------------------	---	---



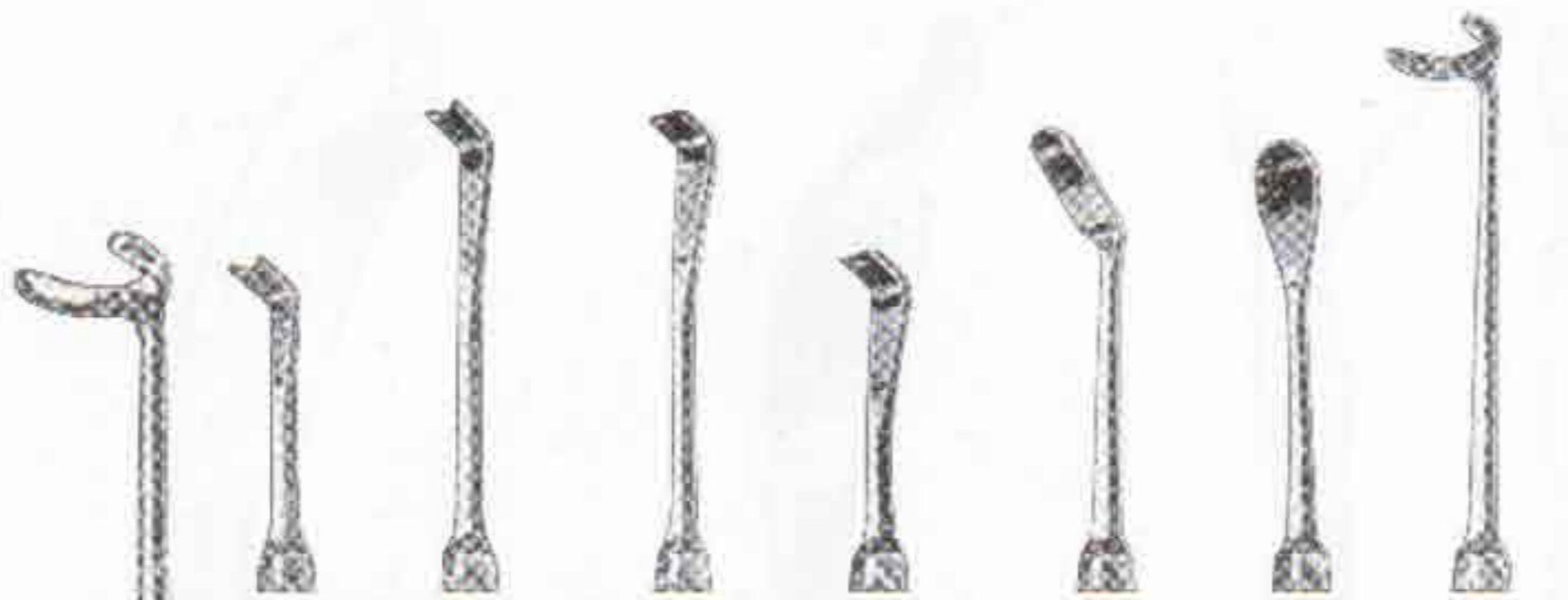

09-1850 09-1851 09-1852 09-1853 09-1854 09-1855 09-1856



Semb

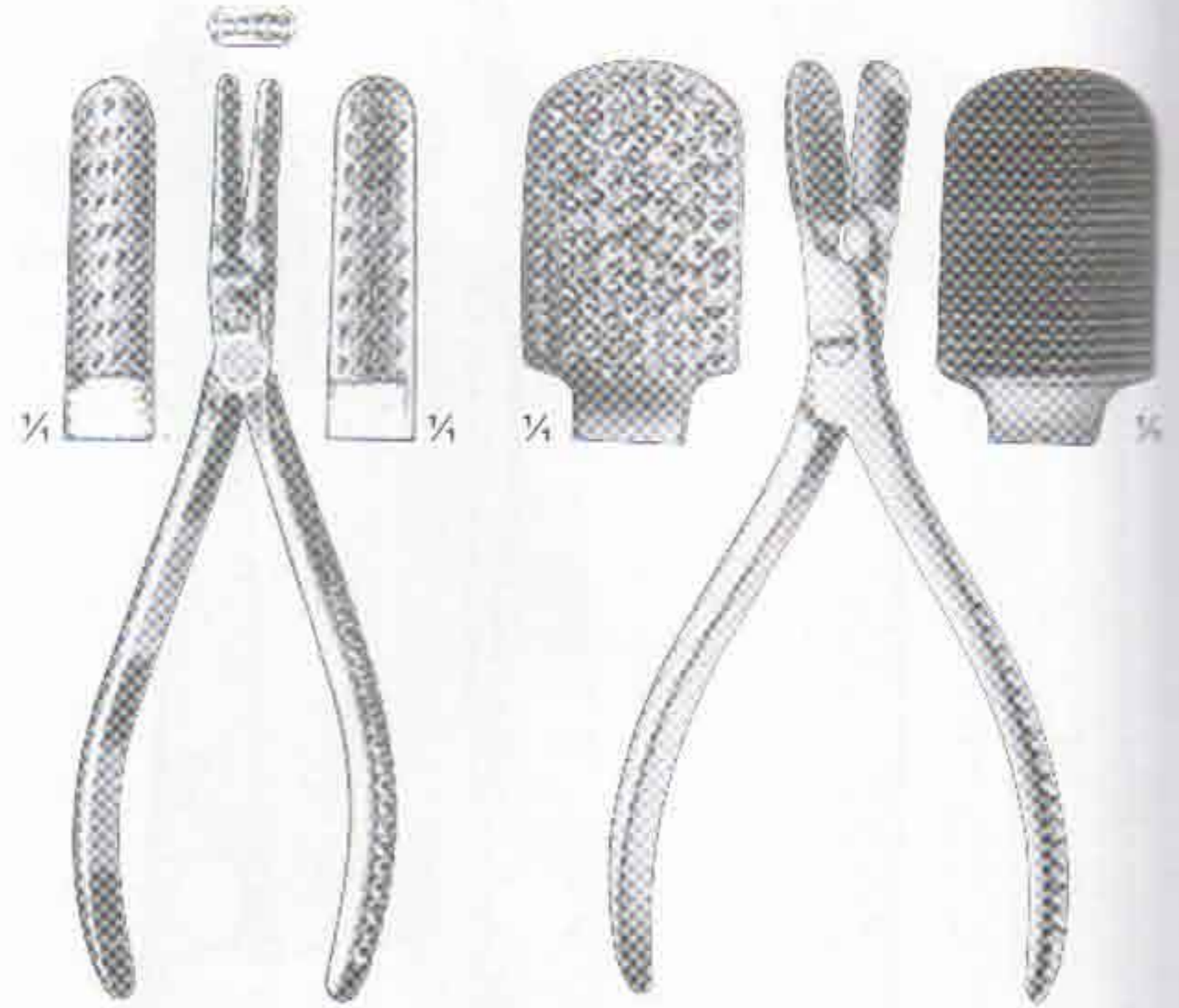

**NAIL EXTRACTING  
FORCEPS**  
09-1860  
14 cm, 5 1/2"

**NAIL EXTRACTING  
FORCEPS**  
09-1870  
14.5 cm, 5 3/4"

Frill points only

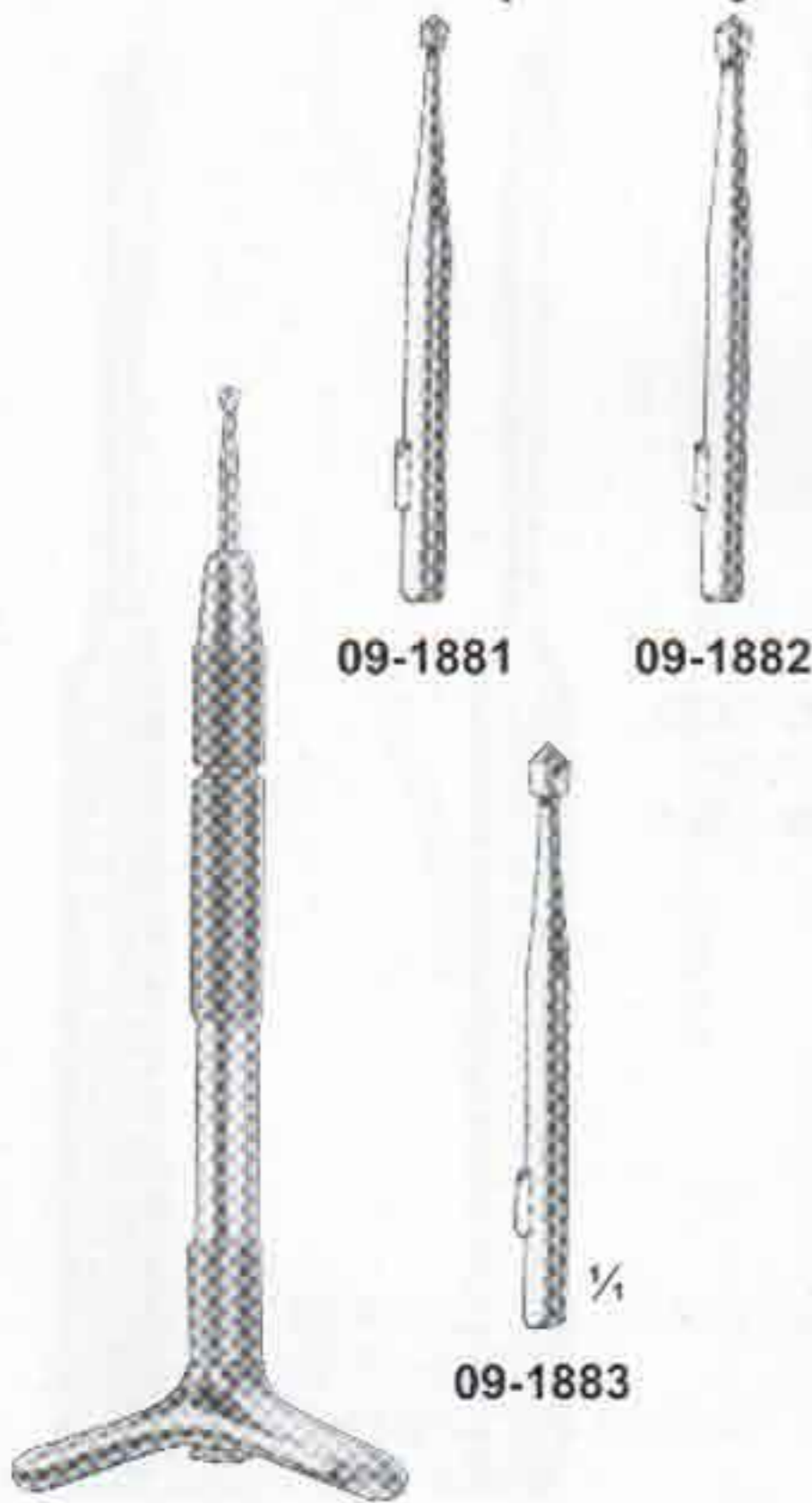

09-1881

09-1882

09-1883

**09-1880**  
Finger nail drill with 3  
drill points

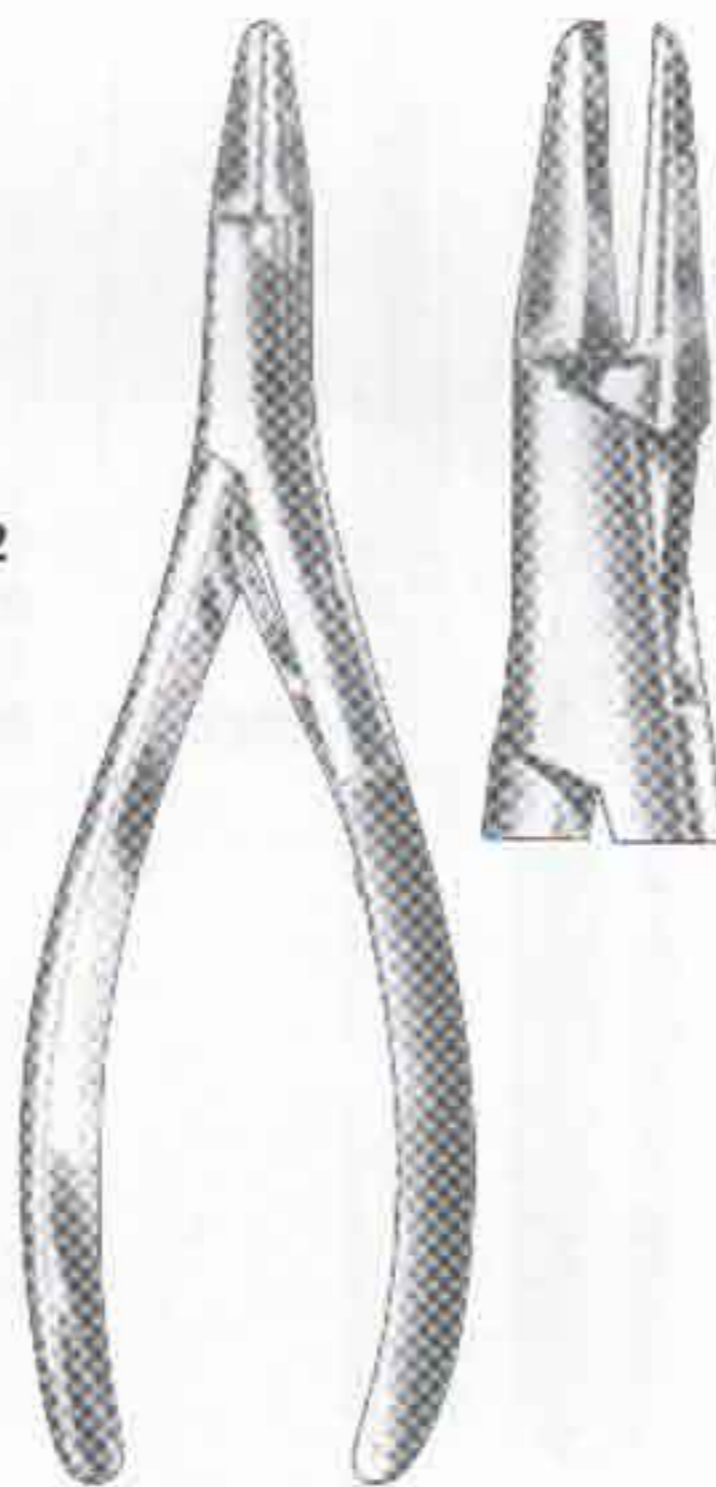

**NAIL SPLITTING  
FORCEPS**  
09-1890  
13.5 cm, 5 1/4"

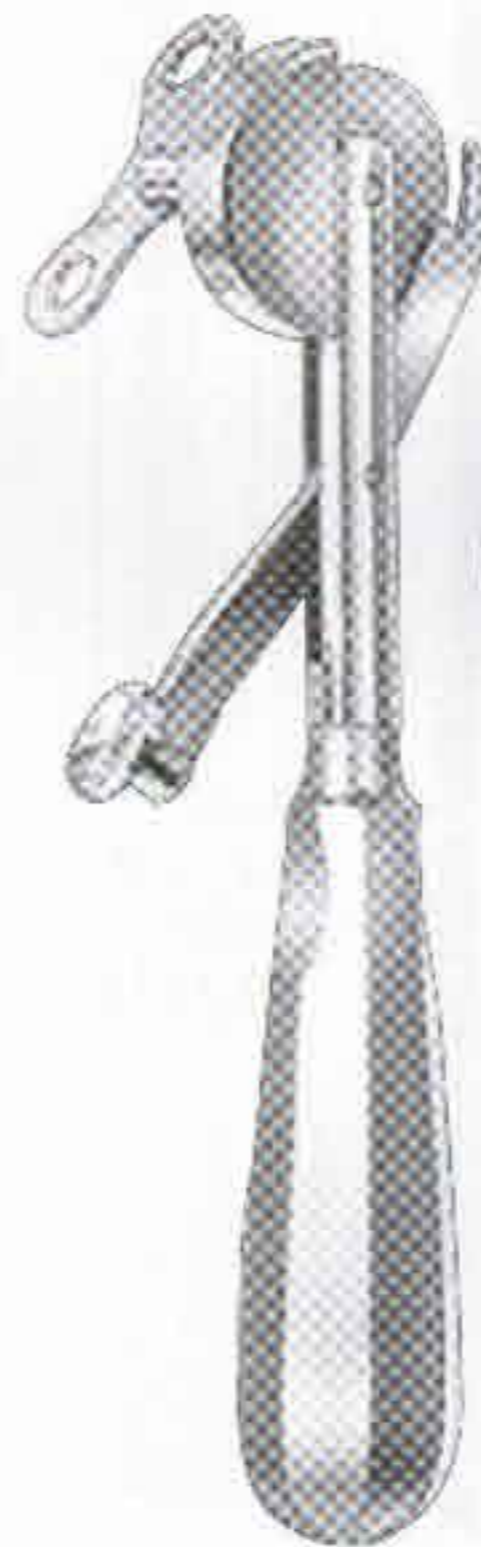

**09-1901**  
Saw Blade Only  
for 09-1900

**RING CUTTER**  
09-1900  
17 cm, 6 3/4"



**09-1911**  
Saw Blade Only  
for 09-1910

**RING CUTTER**  
09-1910  
17 cm, 6 3/4"



# FLAT NOSE PLIERS, TENDON TUNNELLING FORCEPS

Flachzangen, Sehnendurchzugzangen  
 Alicates de pico plano, Pinzas para pasar tendones

Pinces plates, Pinces pour passer les tendons  
 Tenaglie piatte, pinze passa-tendini

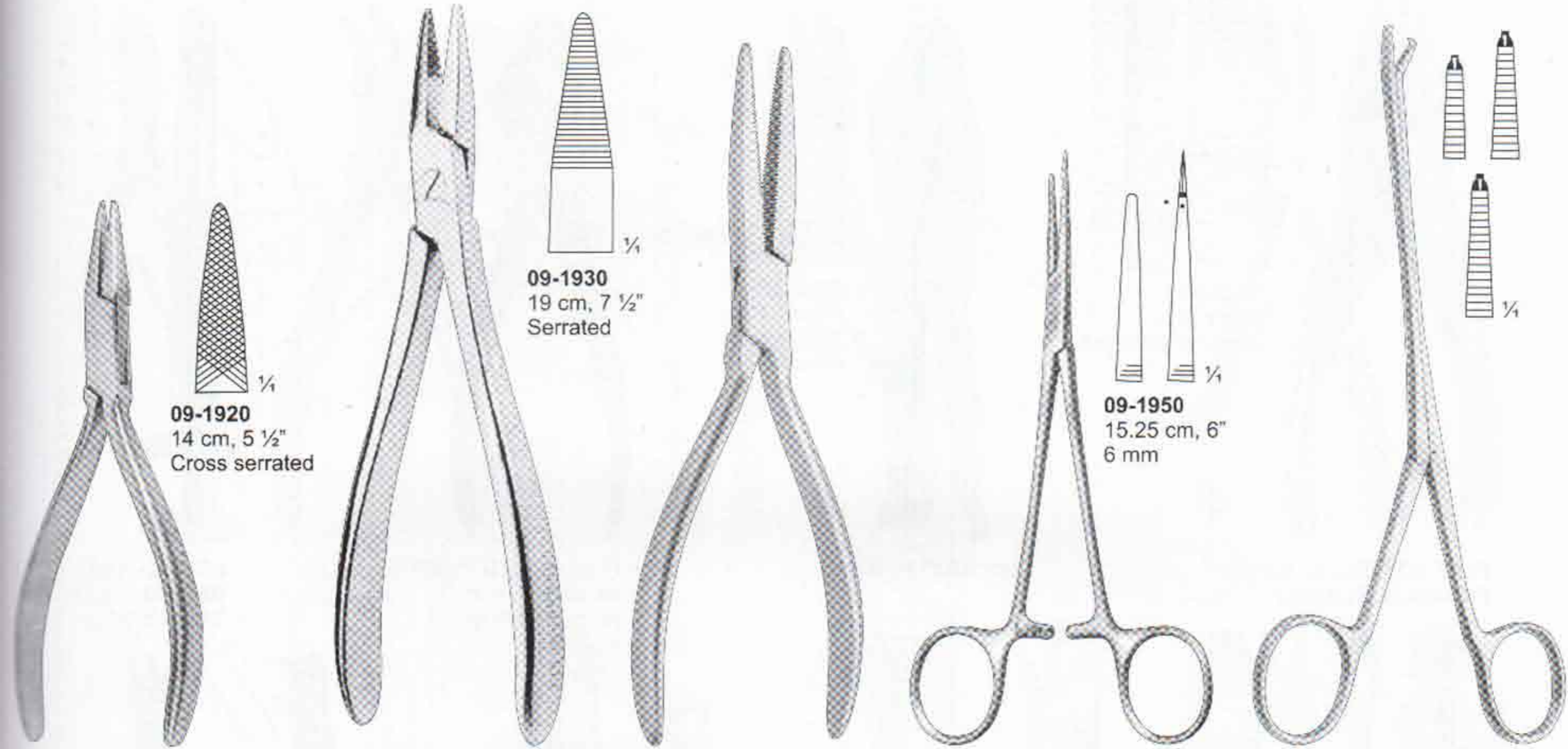

**09-1920**  
 14 cm, 5 1/2"  
 Cross serrated

**09-1930**  
 19 cm, 7 1/2"  
 Serrated

**09-1950**  
 15.25 cm, 6"  
 6 mm

**BRAND**  
**09-1960** 15 cm, 6"  
**09-1961** 19 cm, 7 1/2"  
**09-1962** 24 cm, 9 1/2"

**NEEDLE NOSE PLIERS**

**NEEDLE NOSE PLIERS**

**FLAT NOSE**  
**09-1940**  
 18 cm, 7"

**TENDON**

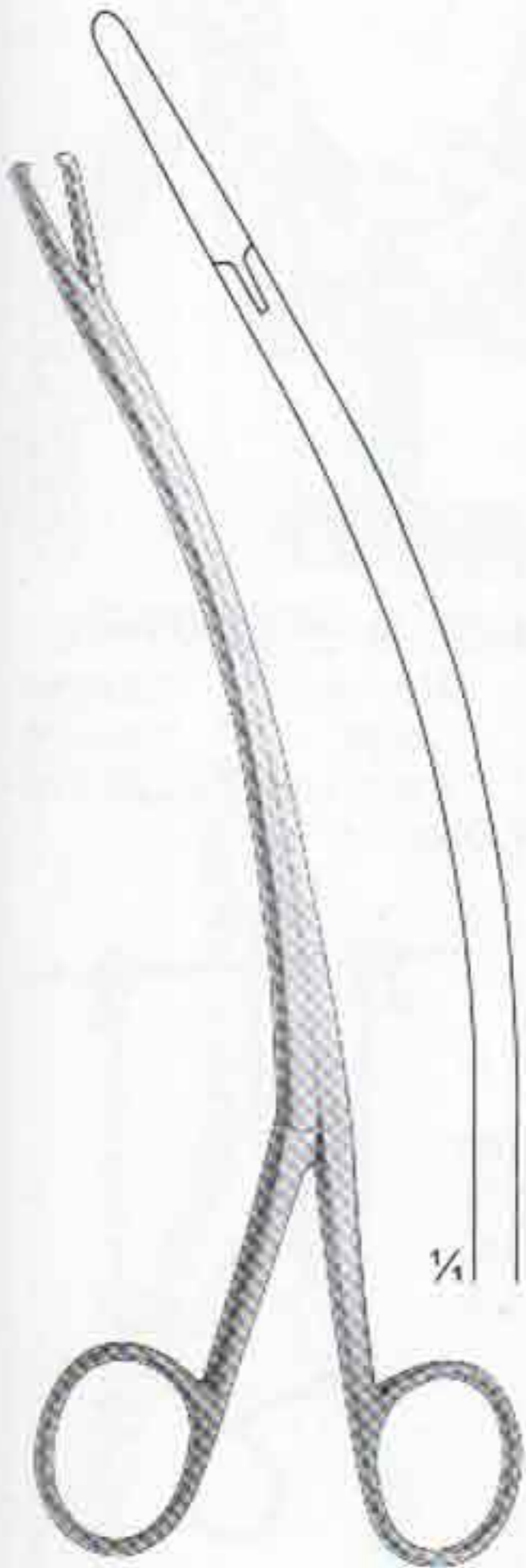

**BRAND**  
**09-1970** 15 cm, 6"  
**09-1971** 19 cm, 7 1/2"  
**09-1972** 24 cm, 9 1/2"

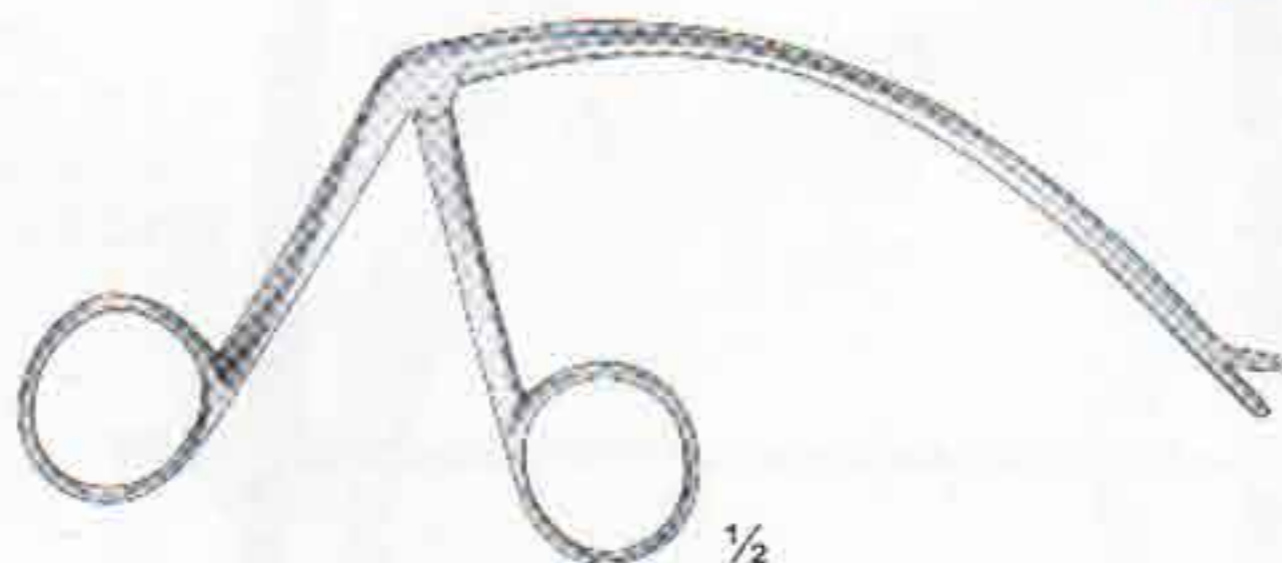

**CARROLL**  
**09-1980**  
 13 cm, 5"  
 Curved Shaft  
 2 mm x 6 mm



**LEAD HAND**  
**09-1990**  
 Adult Size

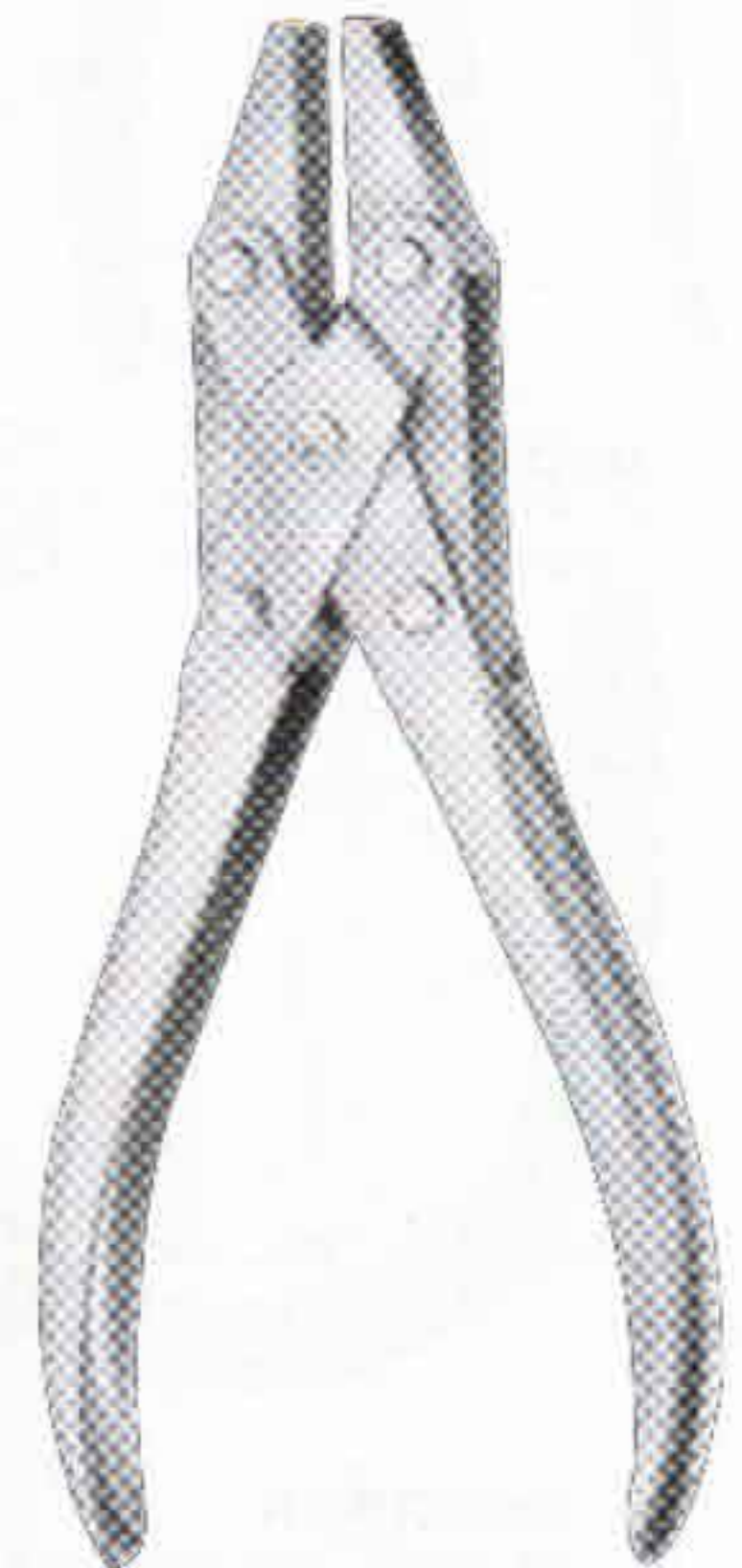

**FLAT NOSED PARALLEL PLIERS**  
**09-2000** 18 cm, 7"  
 with lateral wire cutter



# FLAT NOSE, COMBI-FLAT, VISE GRIP PLIERS

Flachzangen, Tonnenzange, Kombinationszange  
Alicates de pico plano, Combi-Alicate de alambre

Pinces plates, Combi-Pince pour fils  
Tenaglia piatta, Combi-Pinza per fili

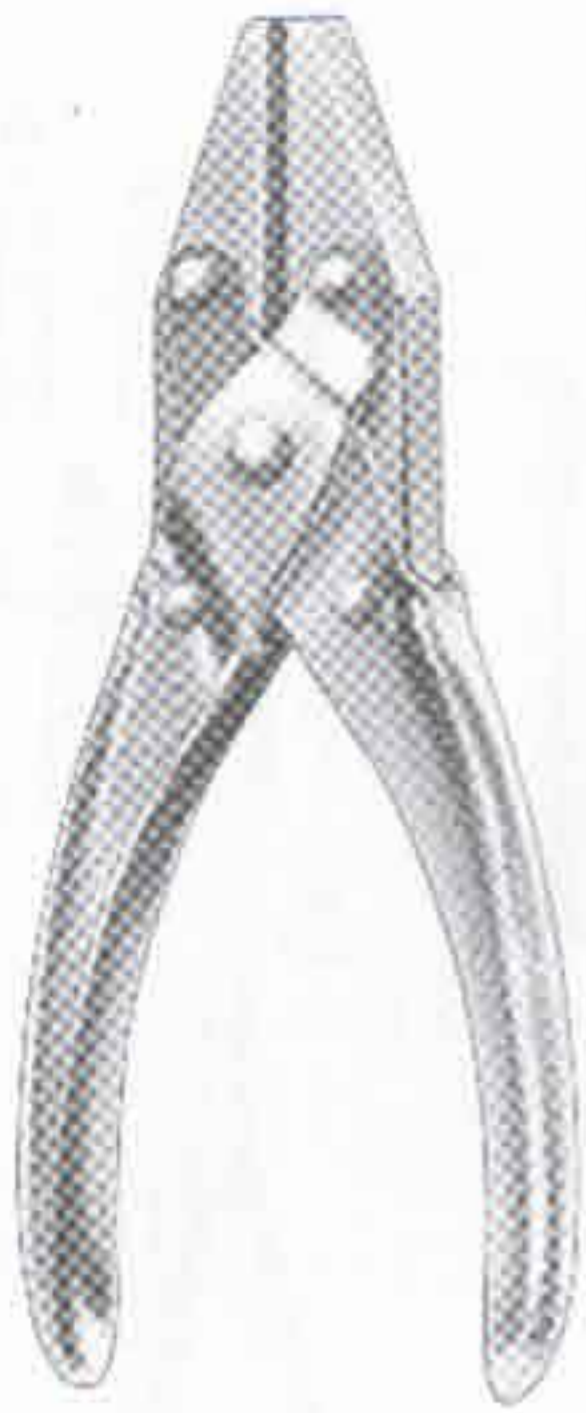

**09-2010**  
17 cm, 6 1/2"  
Grooved, Serrated

**FLAT NOSED  
PARALLEL PLIERS**



**09-2020**  
18 cm, 7"  
With Spring  
serrated

**LOCKING PLIERS**



**FLAT NOSED PLIER**  
**09-2030** 18 cm, 7"  
parallell, with lateral  
wire cutter



**LOUTE**  
**09-2040**  
21 cm, 8 1/2"



**09-2050**  
23 cm, 9"  
3 Prong

**MODEL USA**

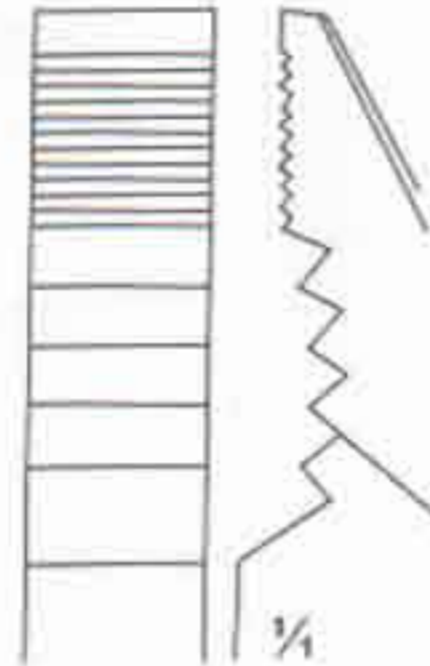

**09-2060**  
19.5 cm, 8"

**SLIP JOINT**

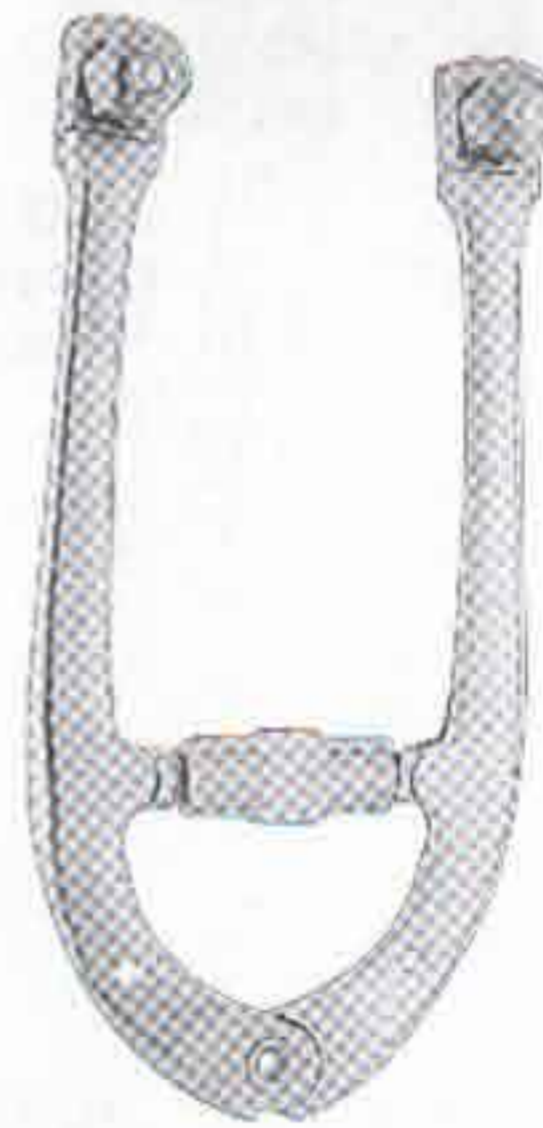

**KIRSCHNER**  
**09-2070** 40 x 140 mm  
**09-2071** 60 x 220 mm



**KIRSCHNER, AMERICAN TYPE**  
**09-2080** Medium 130 mm  
**09-2081** Large 185 mm  
**09-2082** Extra Large 220 mm  
Max. Jaw Opening



**KIRSCHNER**  
**09-2090** 200 mm x 155 mm  
**09-2091** 155 mm x 155 mm  
**09-2092** 135 mm x 130 mm  
**09-2093** 120 mm x 120 mm  
**09-2094** 105 mm x 100 mm  
**09-2095** 95 mm x 110 mm  
**09-2096** 95 mm x 70 mm



**SCREW NUT WRENCH**  
**09-2100**  
14 x 17 mm

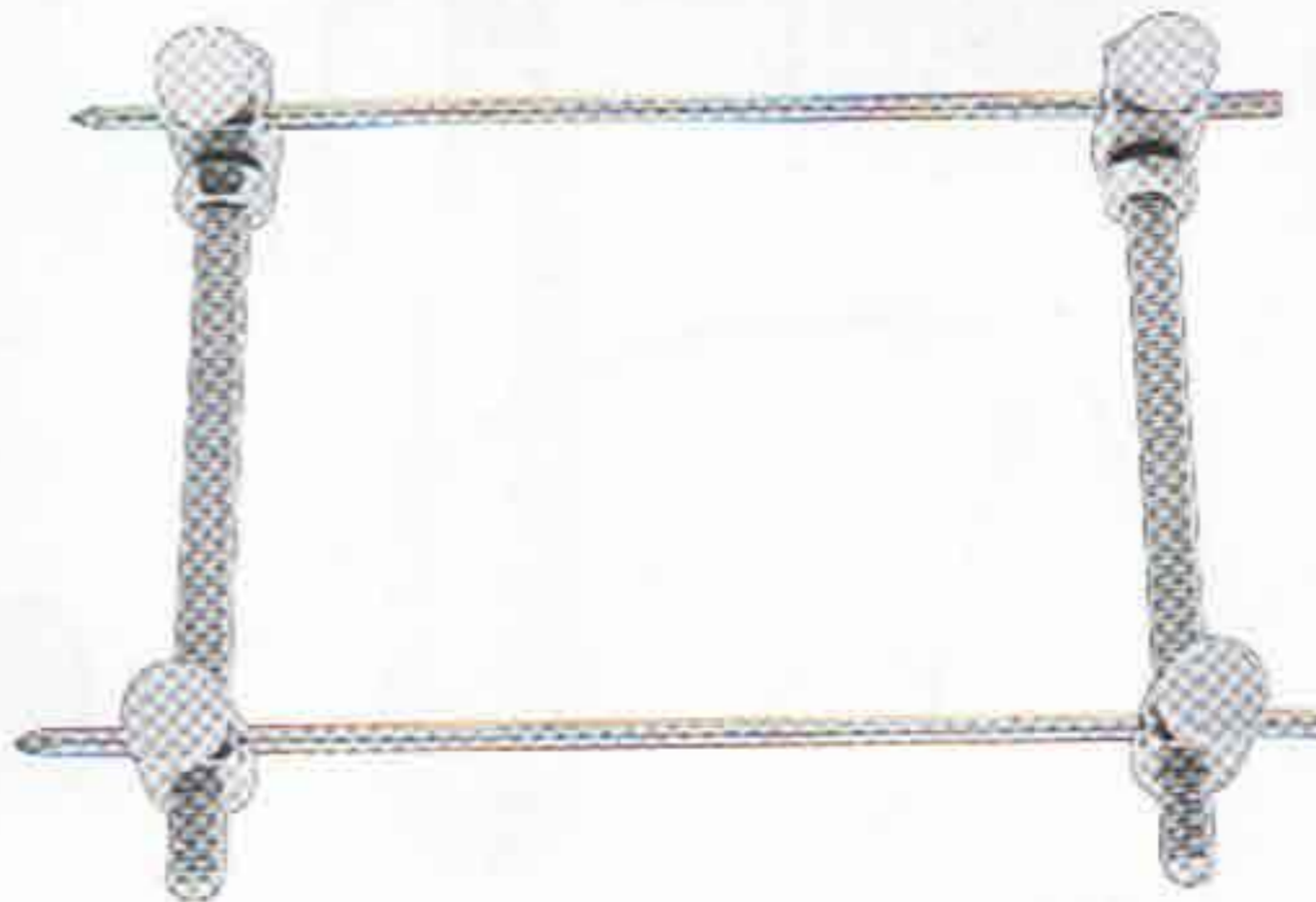

**CHARNLEY-MUELLER**  
**09-2110**  
Compression Clamp



	Inside Length	Inside Width
<b>09-2120</b>	90 mm	75 mm
<b>09-2121</b>	160 mm	90 mm
<b>09-2122</b>	210 mm	110 mm
<b>09-2123</b>	210 mm	150 mm



# BONE RONGEURS

Hohlmeißelzangen  
Pinzas gubias

Pinces-gouges  
Pinze-sgorbie

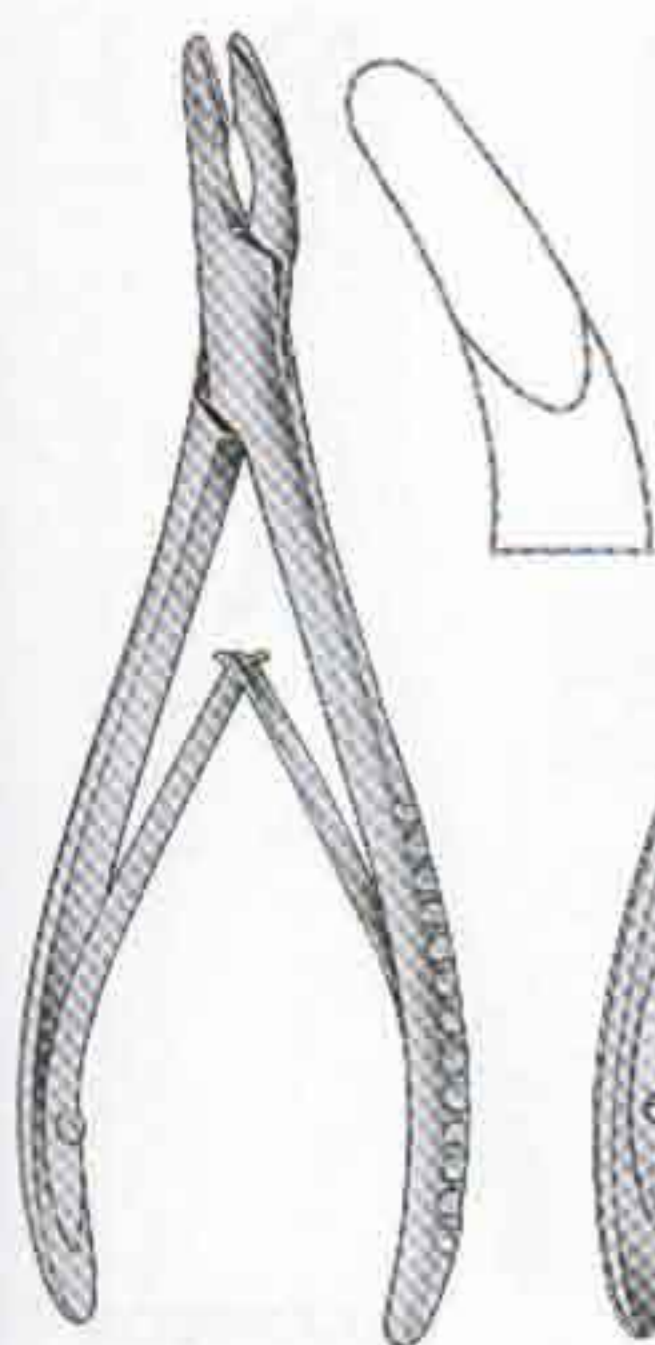

**HARTMANN**  
09-2130  
18.5 cm, 7 1/4"

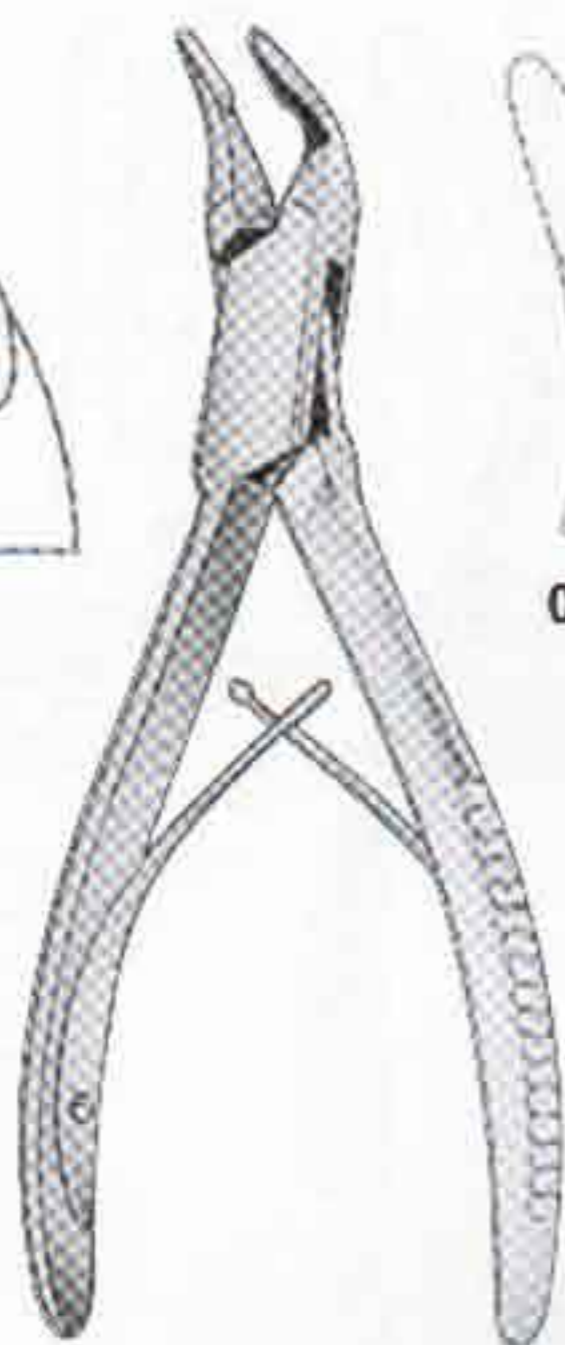

**BLUMENTHAL**  
15 cm, 6"

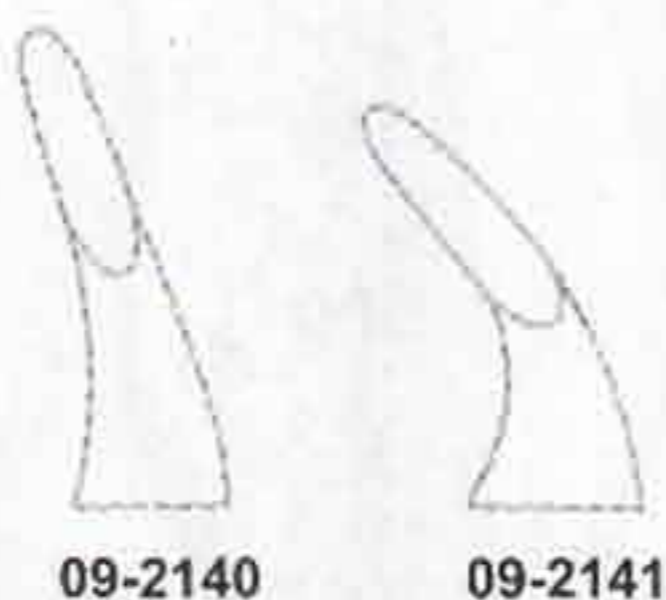

09-2140 09-2141

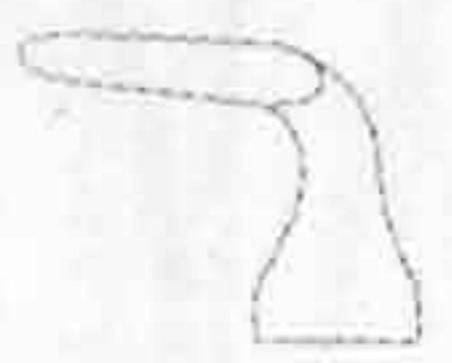

09-2142

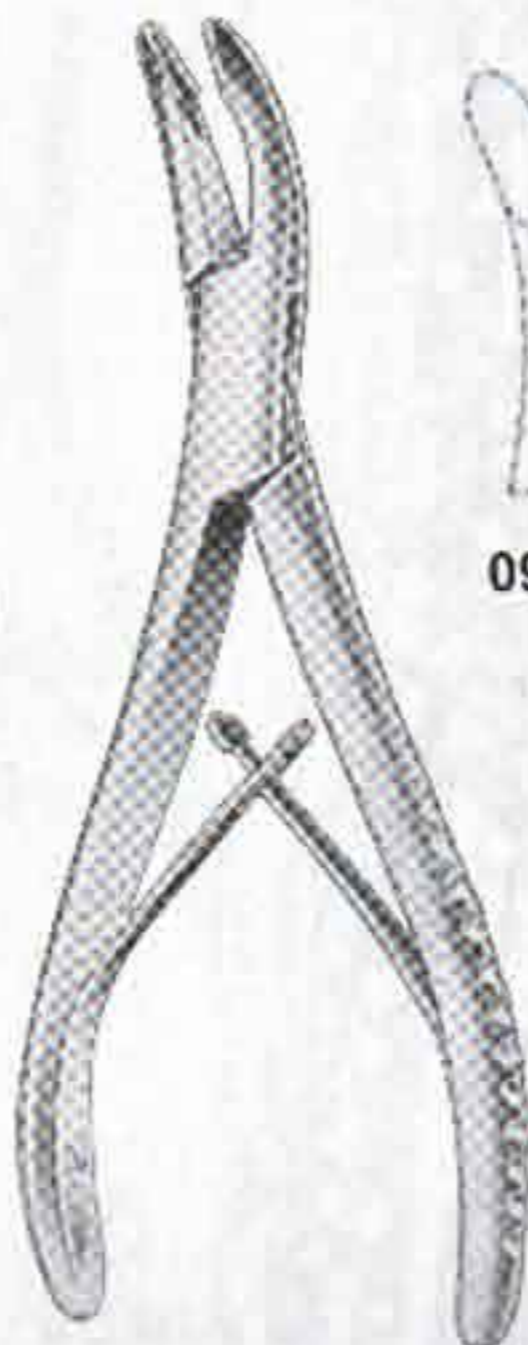

**LUER**  
15 cm, 6"

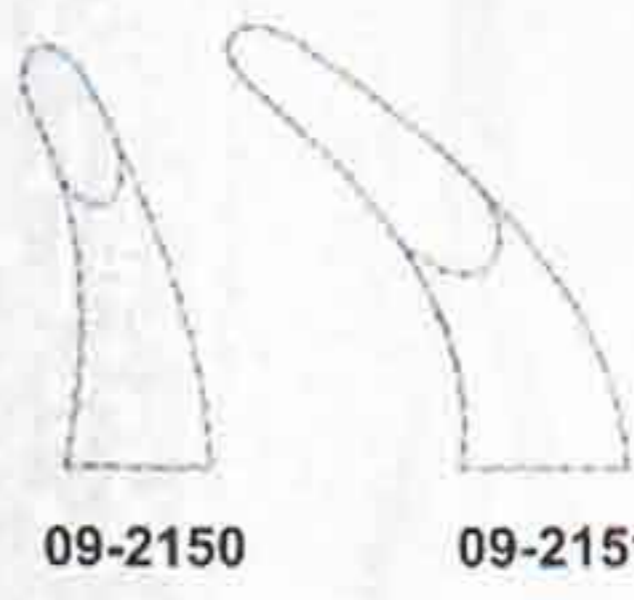

09-2150 09-2151



09-2152

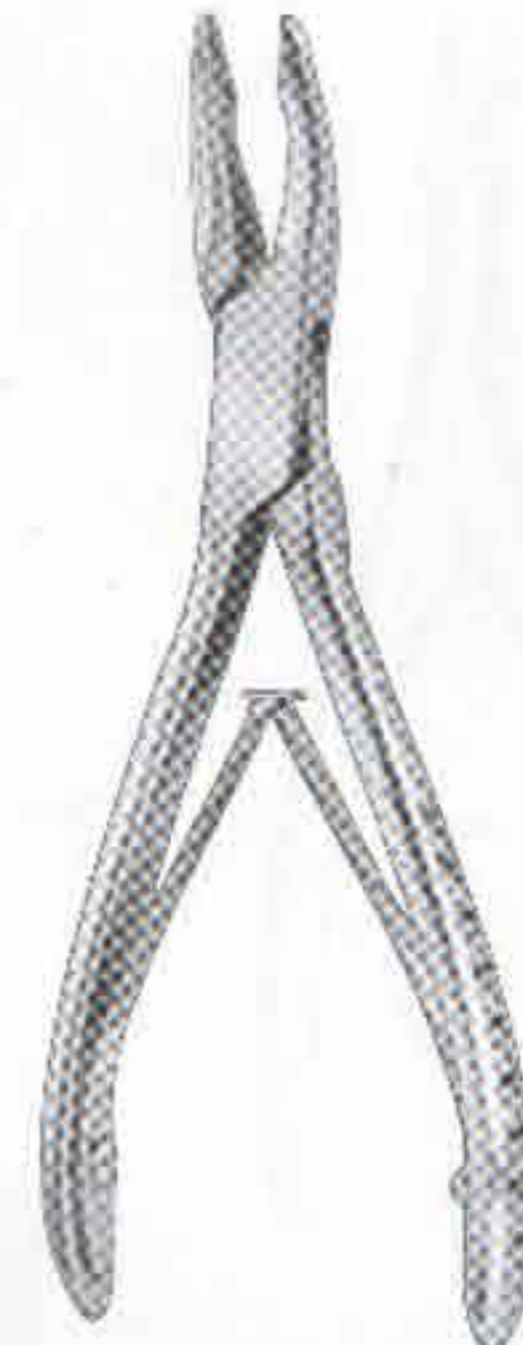

**FRIEDMAN & MINI-FRIEDMAN**



09-2160  
12 cm, 4 3/4"  
Curved



09-2161  
14 cm, 5 1/2"  
Curved

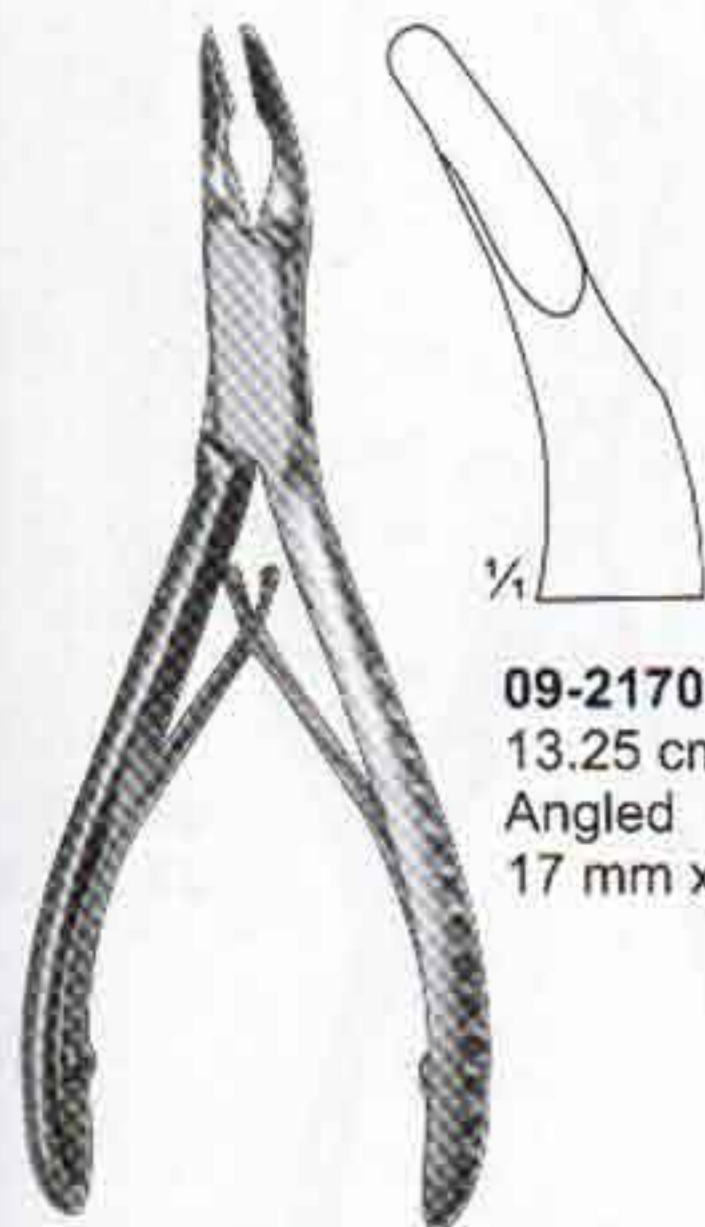

**UNIVERSAL**

09-2170  
13.25 cm, 5 1/2"  
Angled  
17 mm x 3.5 mm

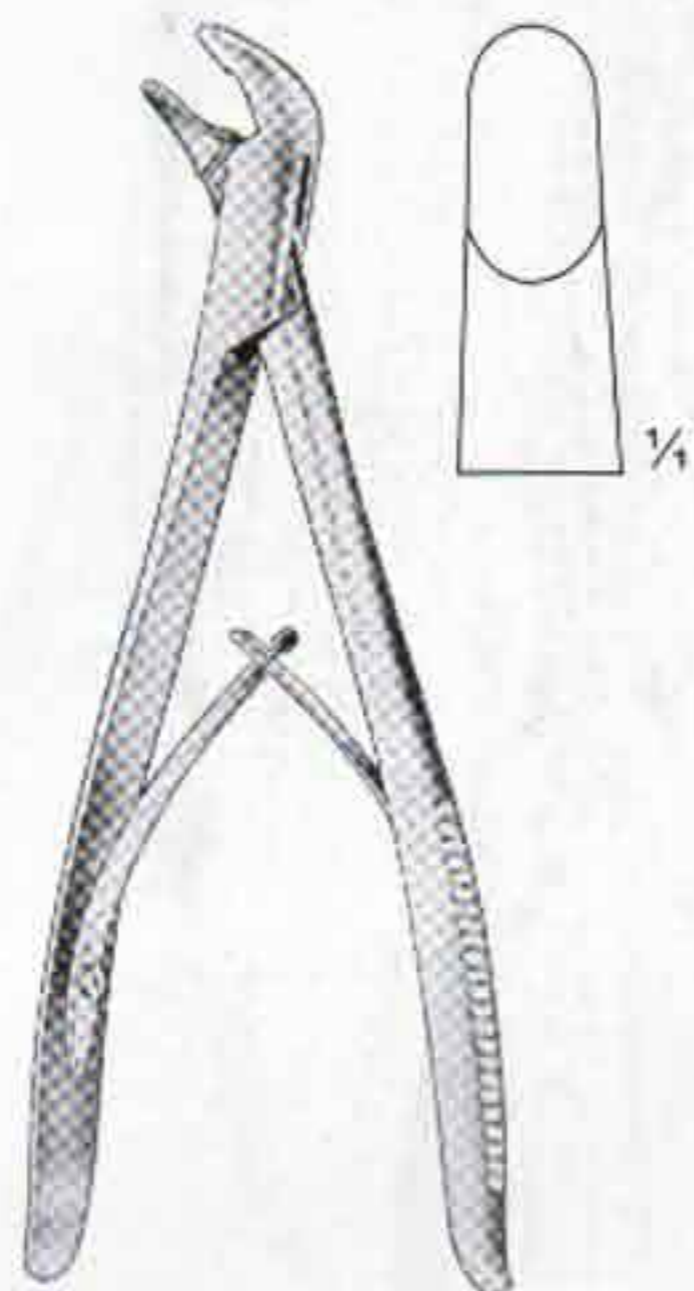

**BACON**  
09-2180  
20 cm, 8"

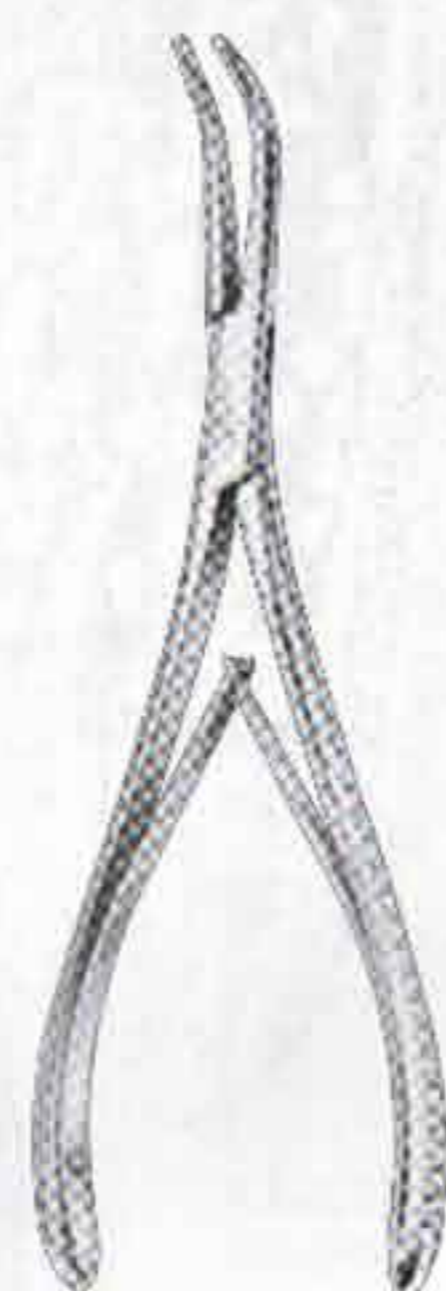

**STELLBRINK  
SYNOVCTOMY  
RONGEUR**



09-2190  
17.5 cm, 7"



09-2191  
17 cm, 6 3/4"

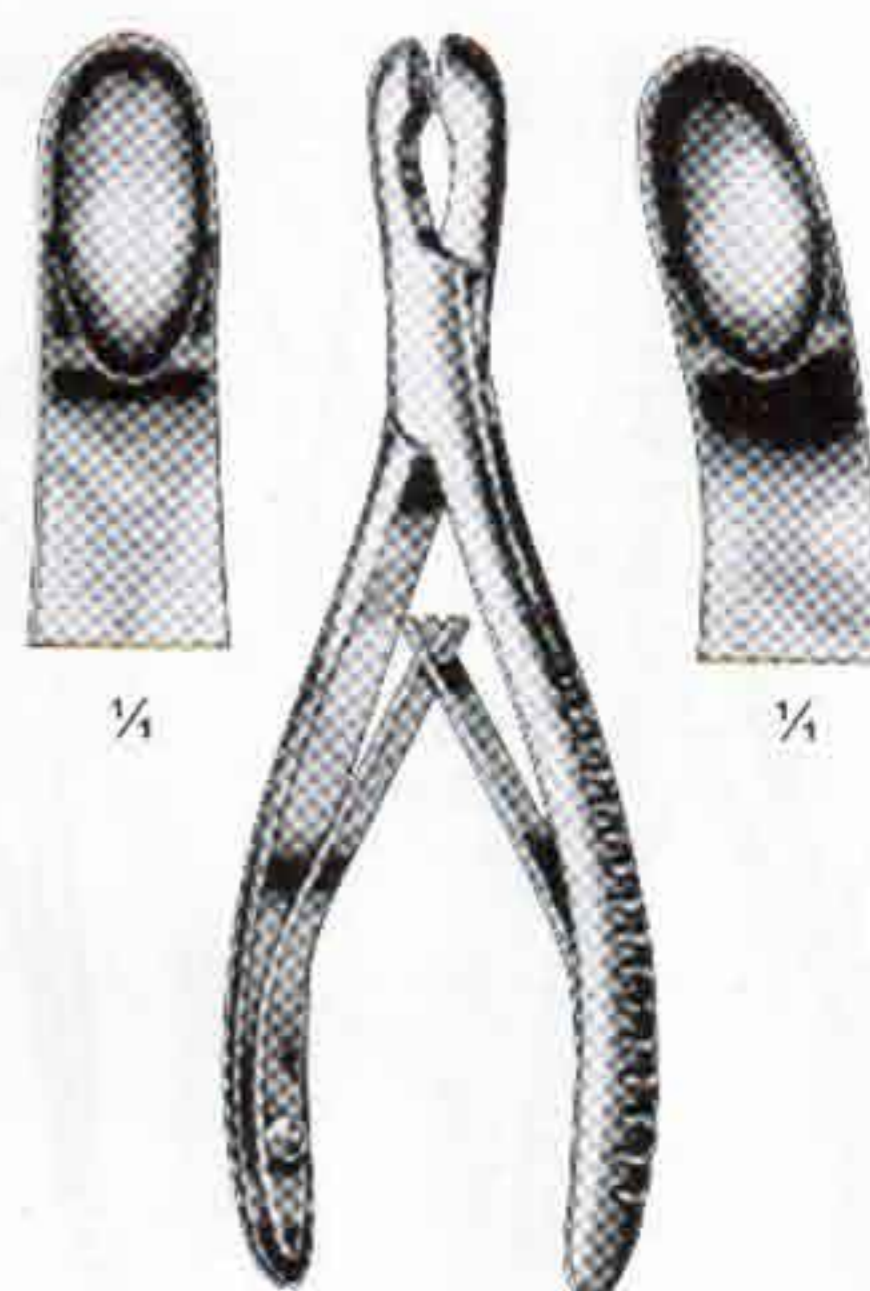

**LUER**  
09-2200 17 cm, 6 3/4" straight  
09-2201 17 cm, 6 3/4" curved

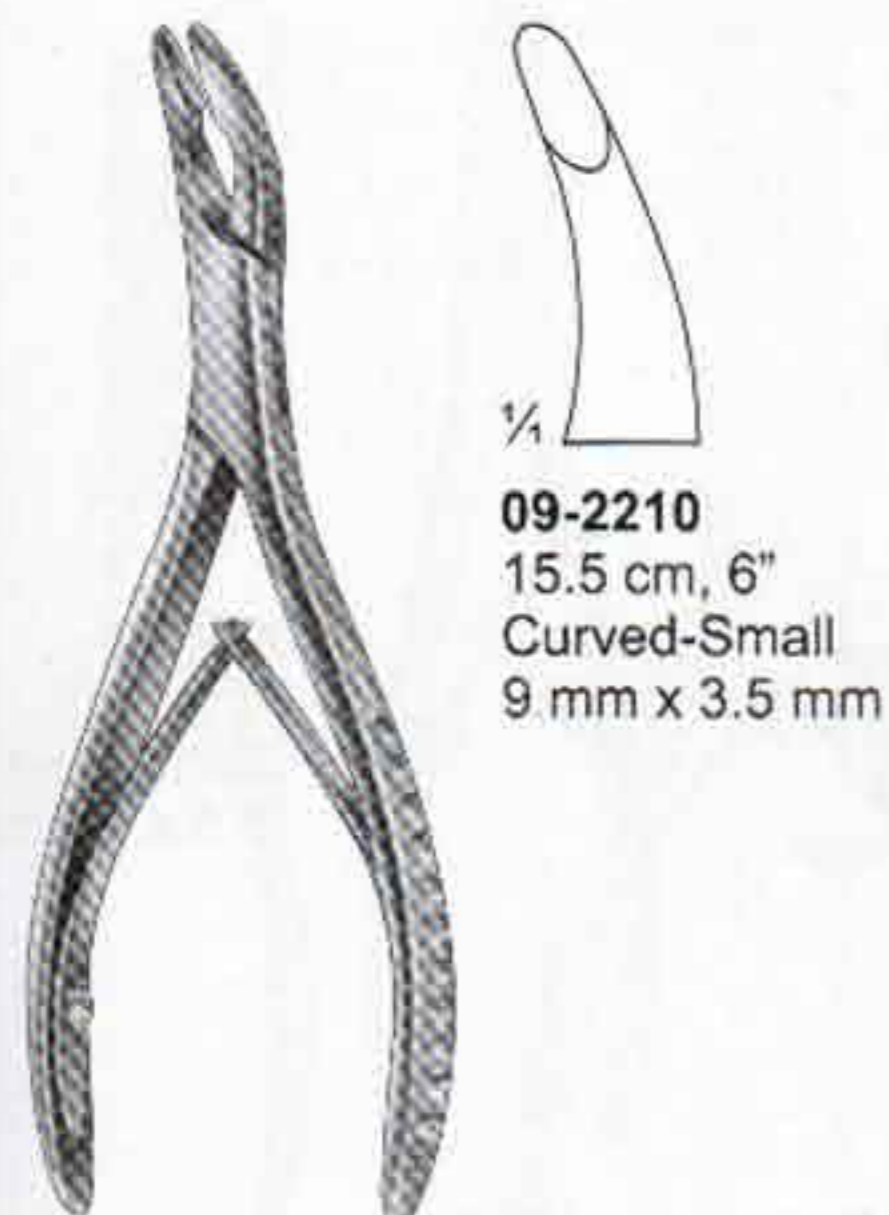

**LUER**

09-2210  
15.5 cm, 6"  
Curved-Small  
9 mm x 3.5 mm

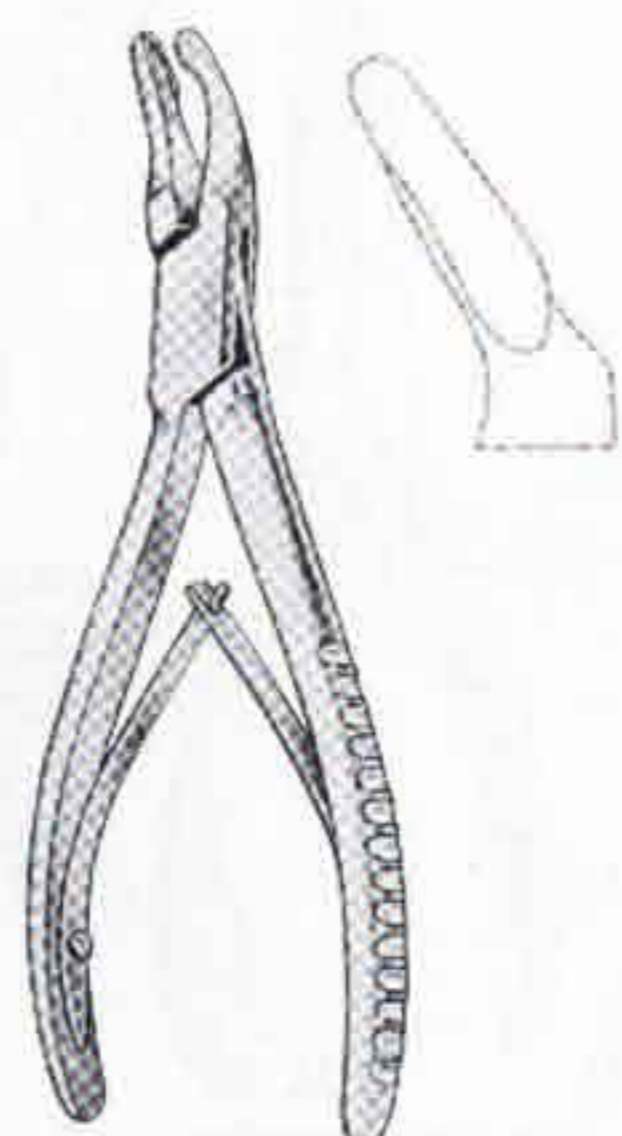

**CLEVELAND**  
09-2220  
14 cm, 5 1/2"

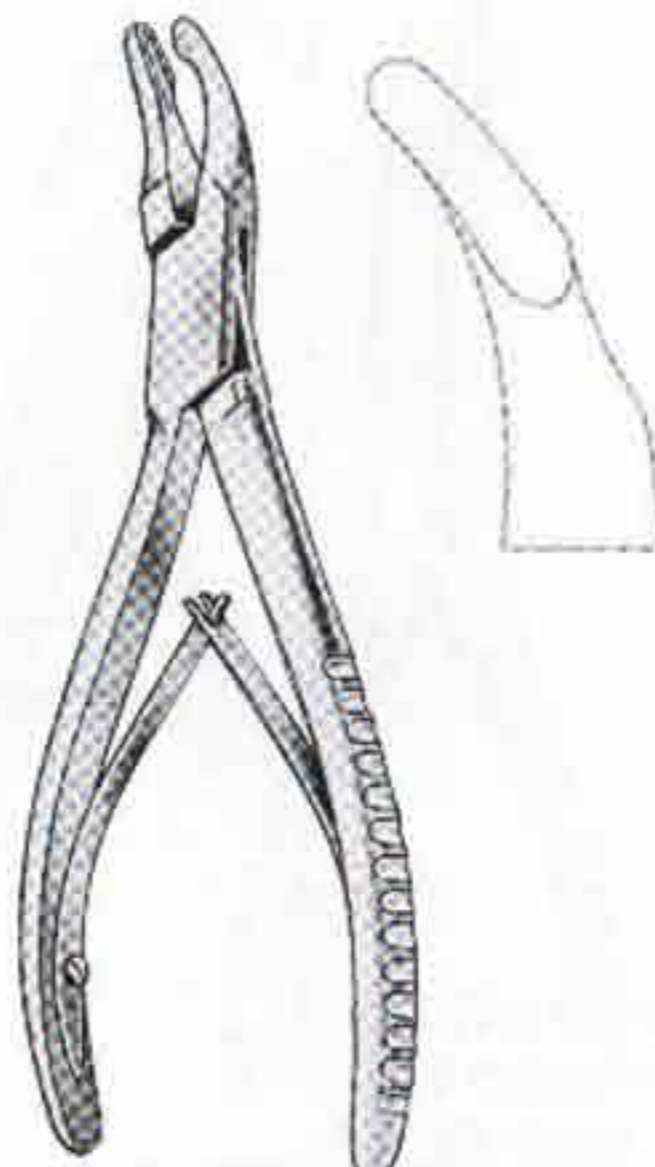

**CLEVELAND**  
09-2230  
17 cm, 6 3/4"

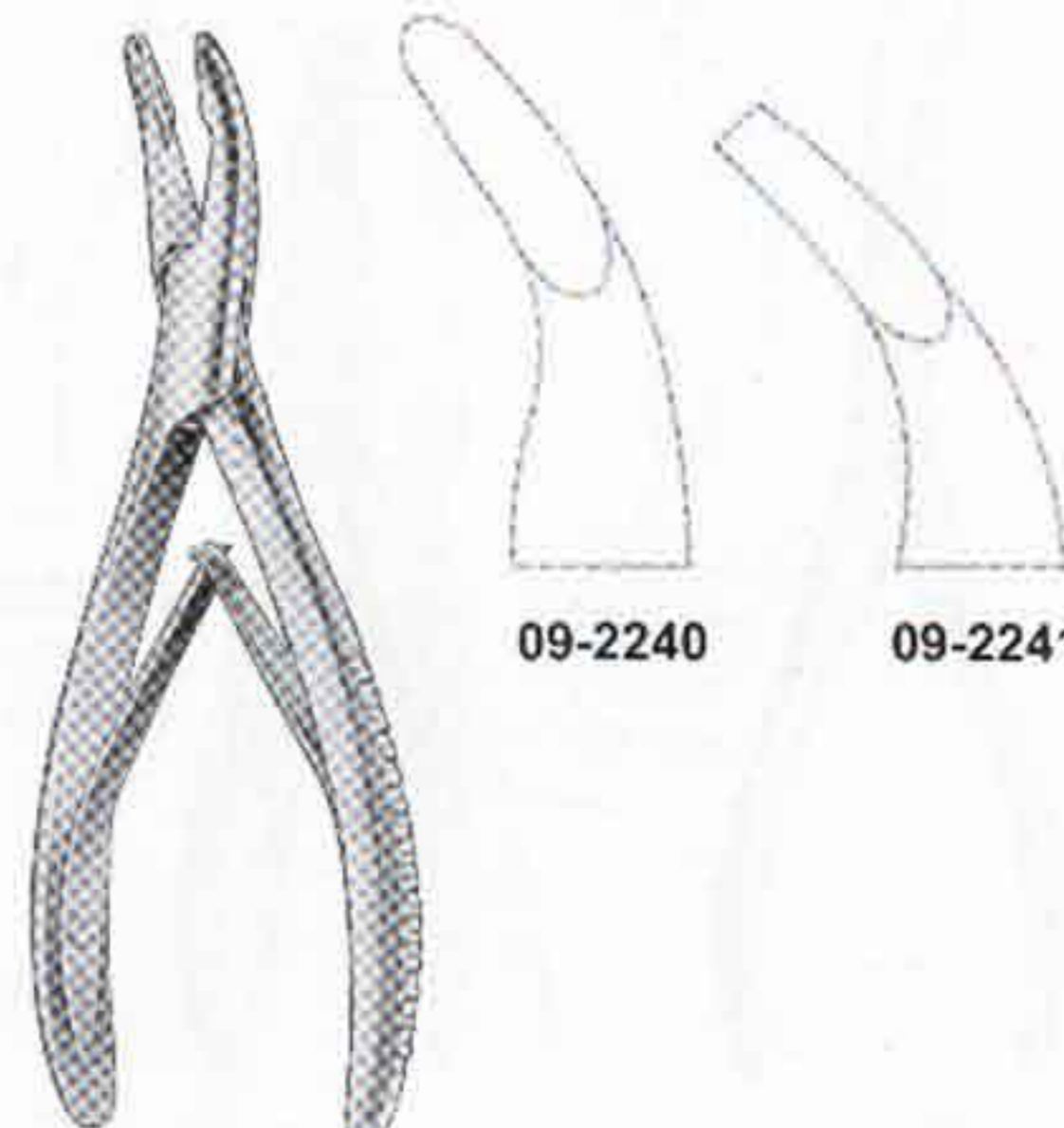

**MEAD**  
16.5 cm, 6 1/2"

09-2240 09-2241



# BONE RONGEURS

Hohlmeißelzangen  
Pinzas gubias

Pinces-gouges  
Pinze-sgorbie



**LEMPERT**  
09-2250 19 cm, 7 1/2" straight  
09-2251 19 cm, 7 1/2" curved



**LEMPERT**

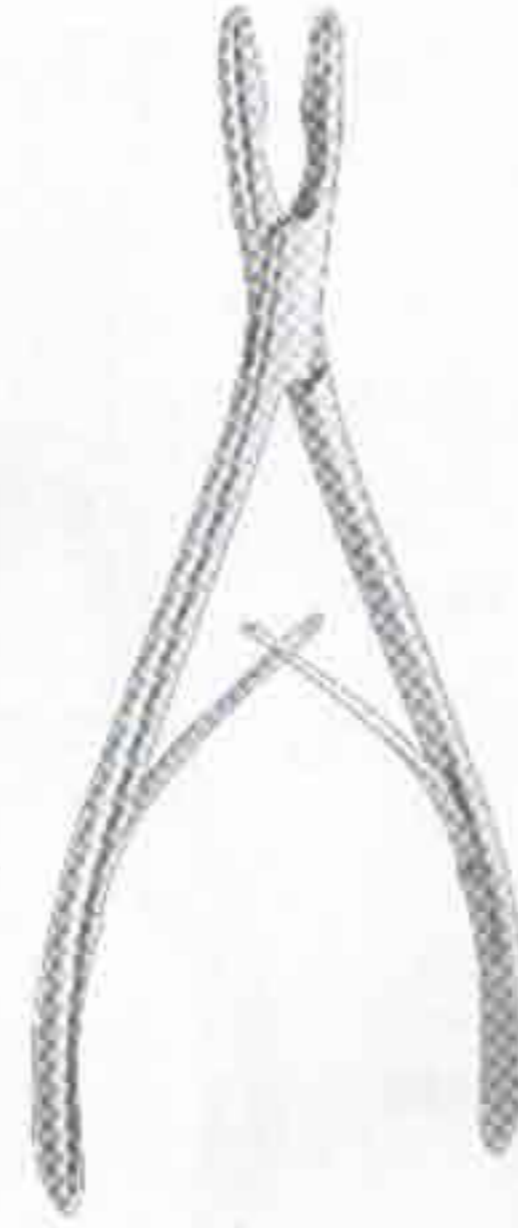

**ADSON**  
09-2270  
20 cm, 8" Straight  
15 mm x 7.5 mm

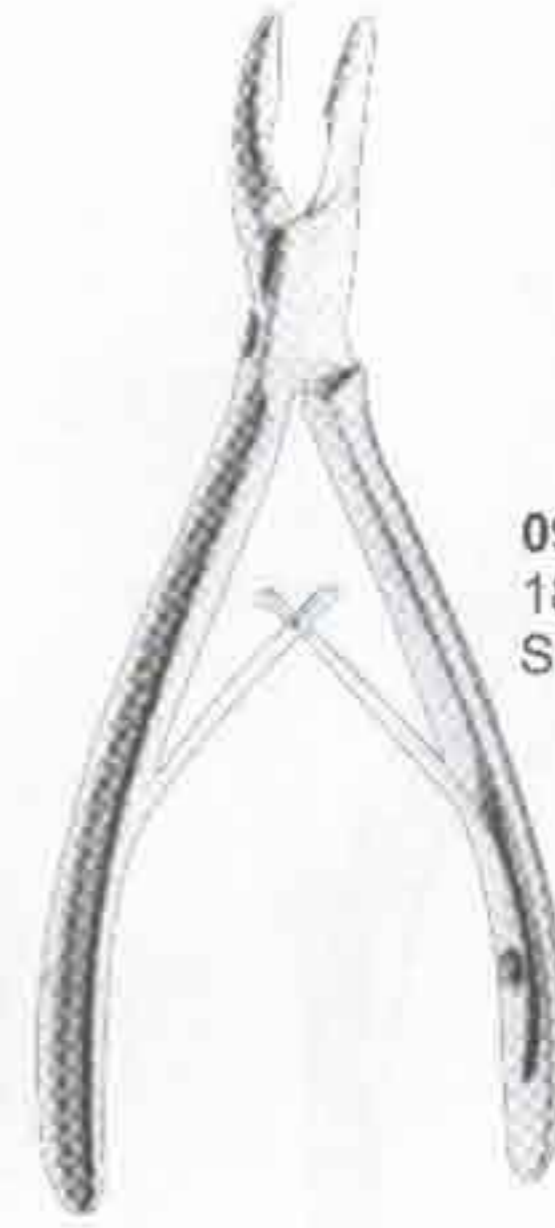

**BANE**

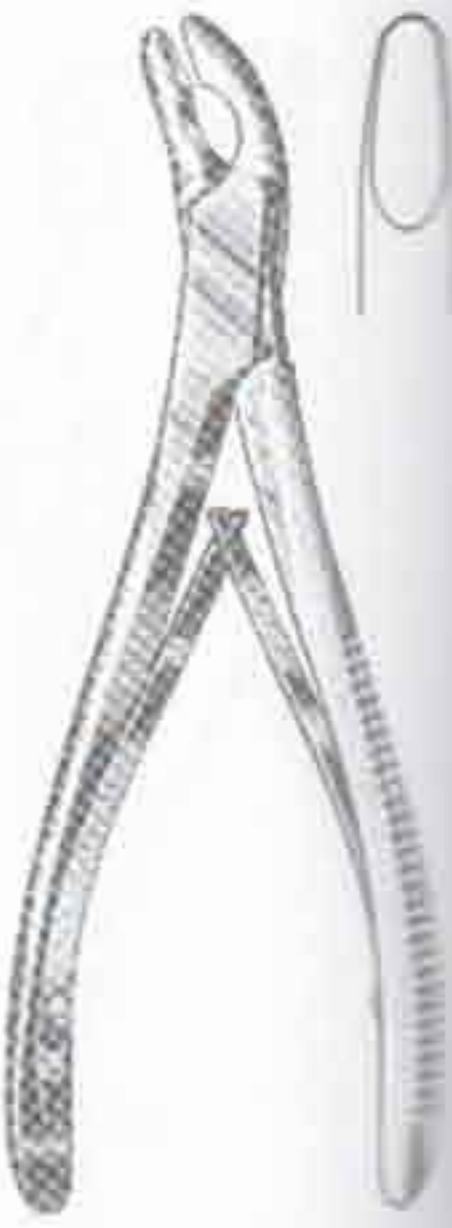

**HAKANSSON**  
09-2290  
15.5 cm, 6"

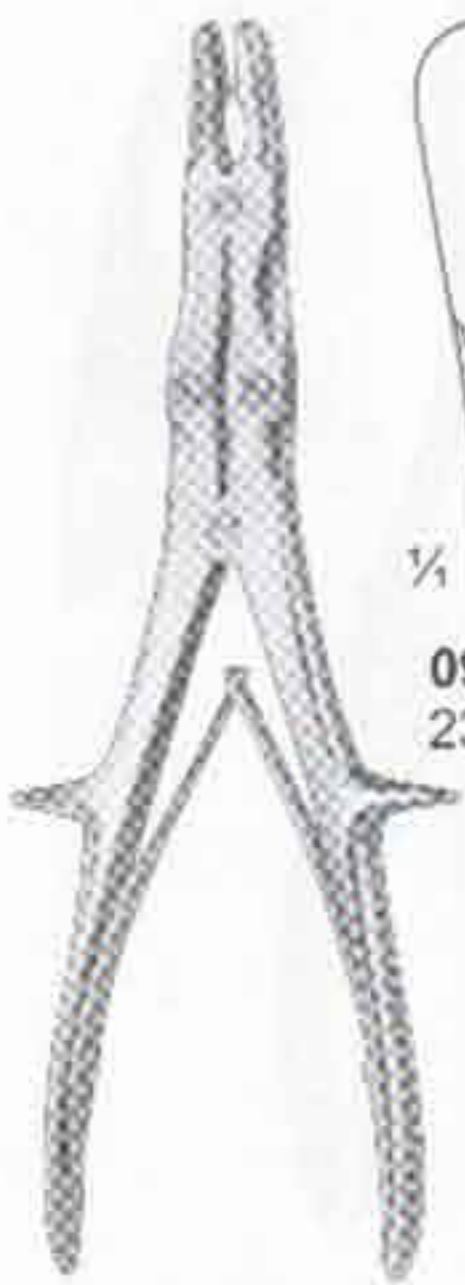

**STILLE-RUSKIN**

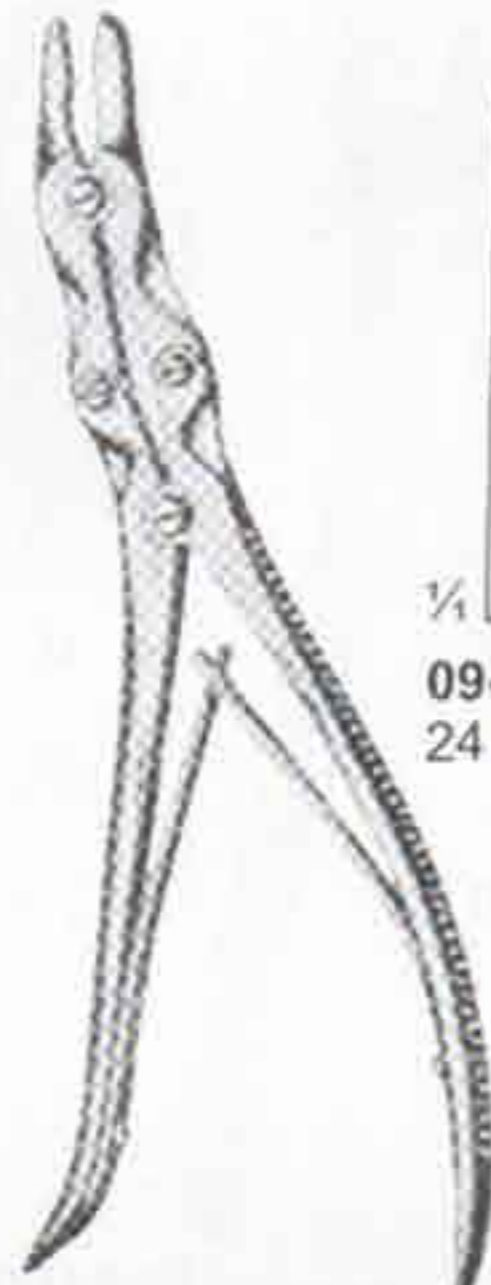
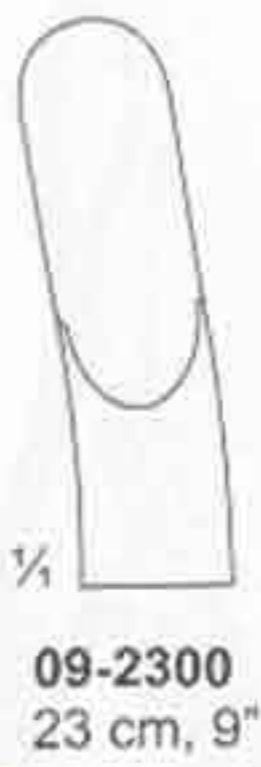

**LEKSELL-STILLE**

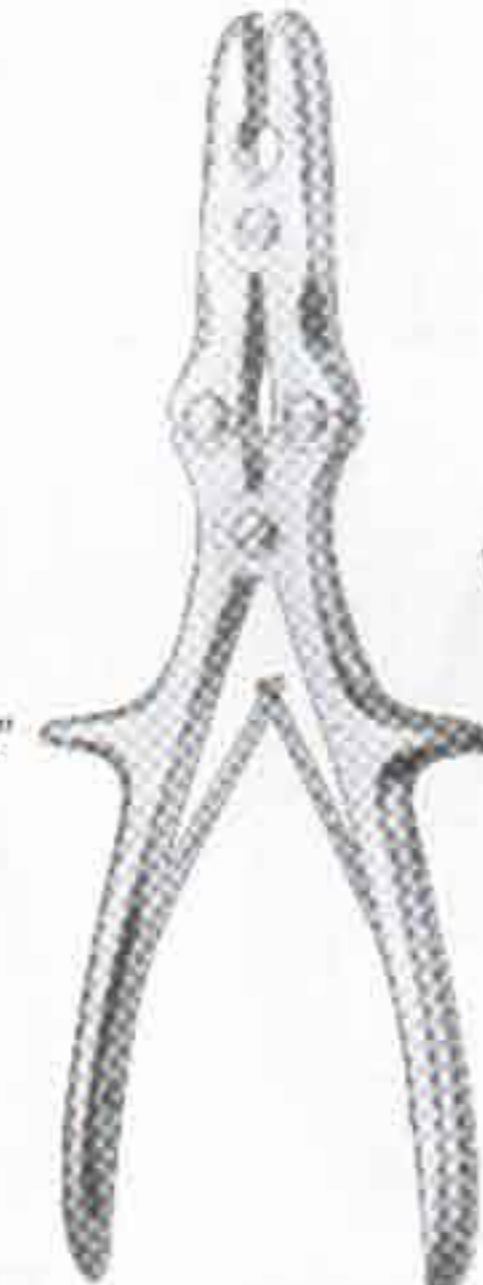

**STILLE-LUER**

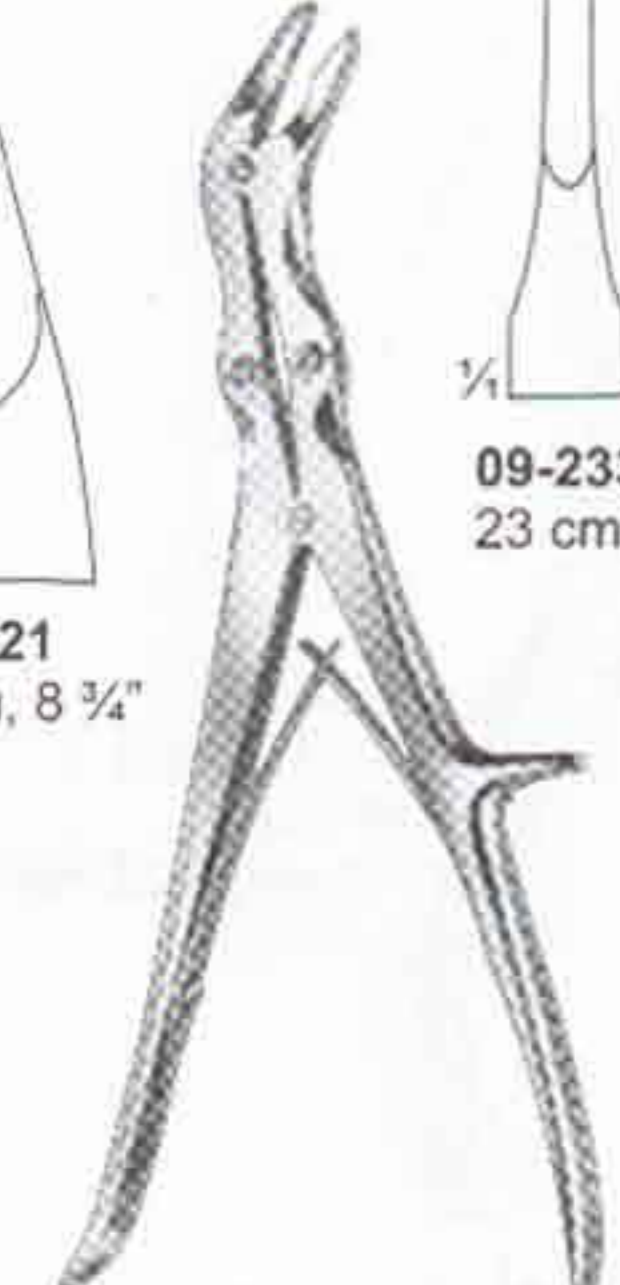

**ECHLIN / STILLE-LUER**



**BEYER RONGEUR**  
09-2340  
18 cm, 7" curved

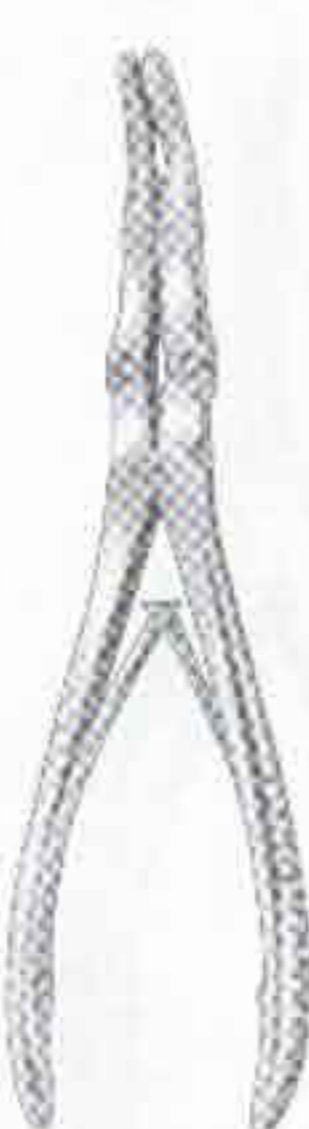

**MAYFIELD**

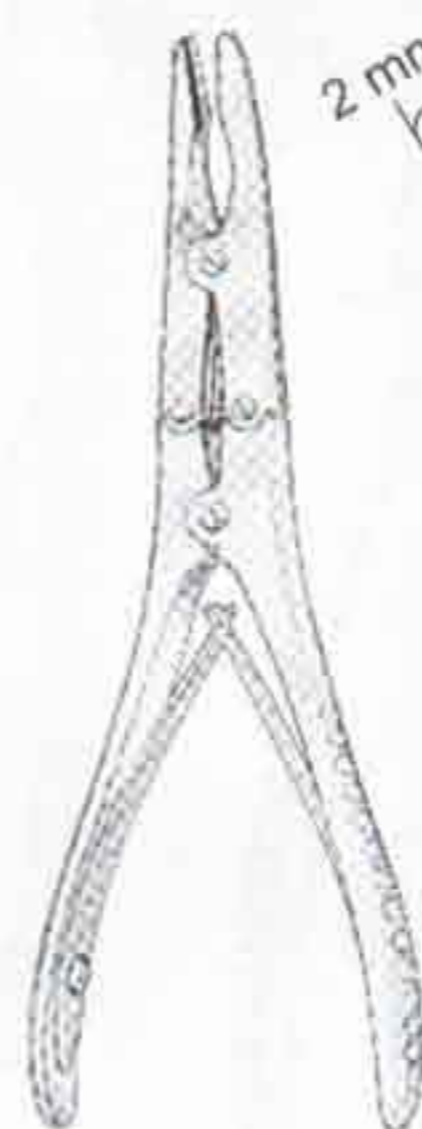

**KLEINERT-KUTZ**

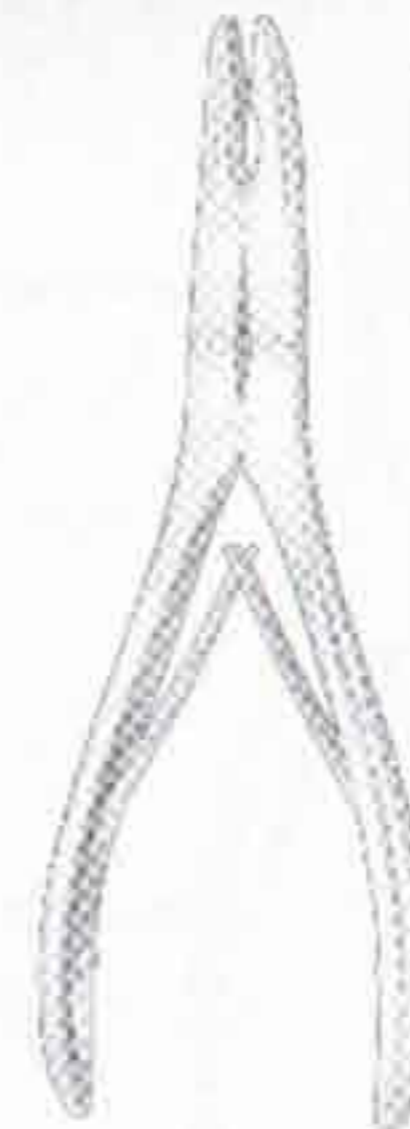
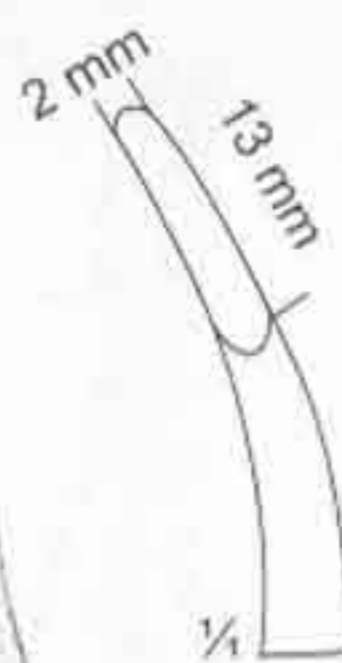

**RUSKIN-MINI**



**RUSKIN**

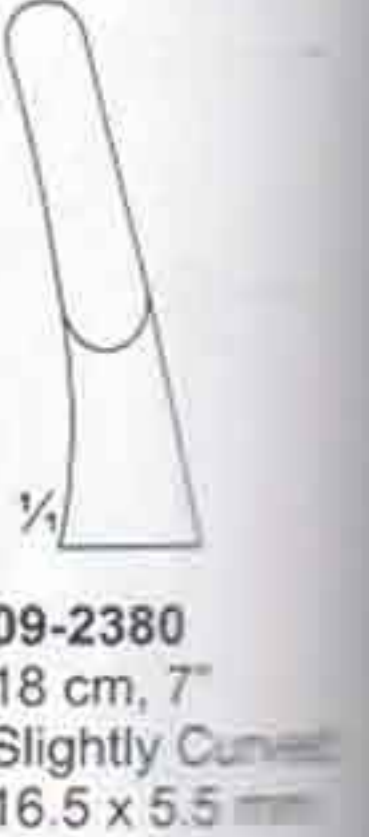



# BONE RONGEURS

Hohlmeißelzangen  
Pinzas gubias

Pinces-gouges  
Pinze-sgorbie



**09-2390**  
15.25 cm, 6"  
Straight



**09-2391**  
15.25 cm, 6"  
Slight Curve

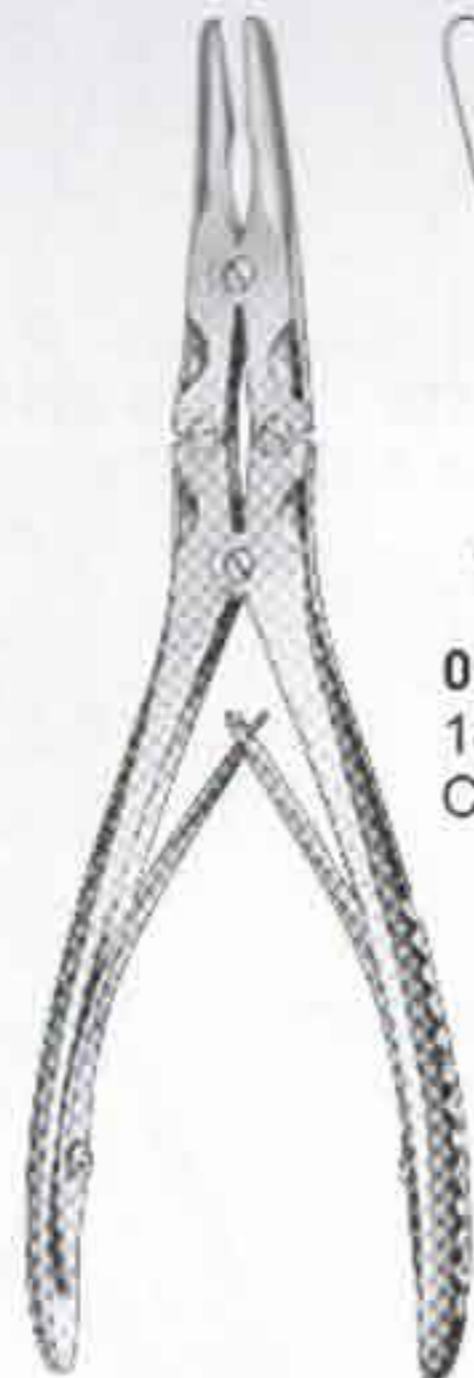

**09-2400**  
18 cm, 7"  
Curved

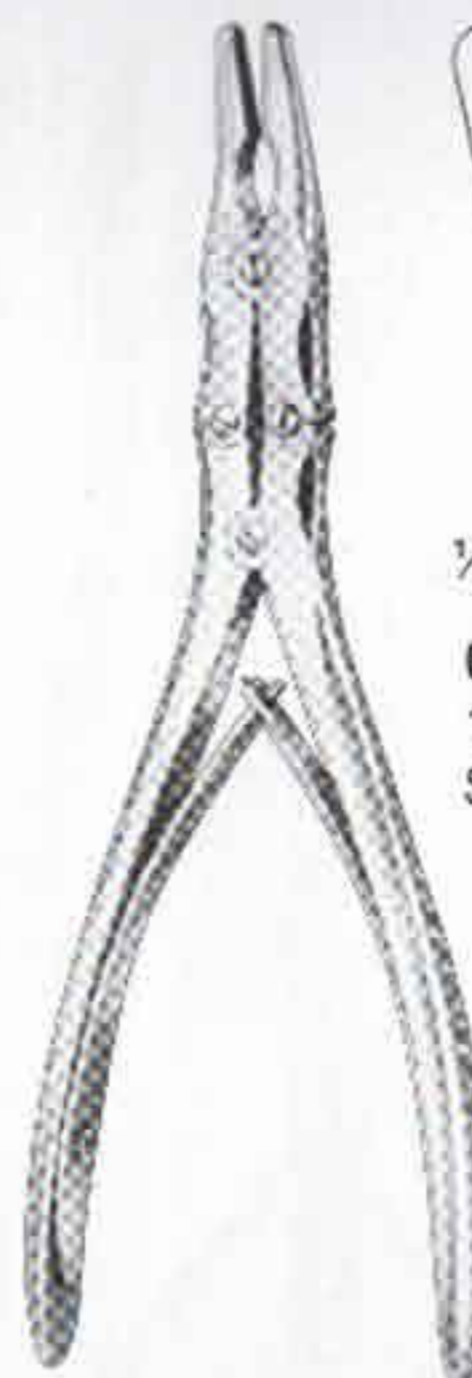

**09-2410**  
18 cm, 7"  
Slightly Curved

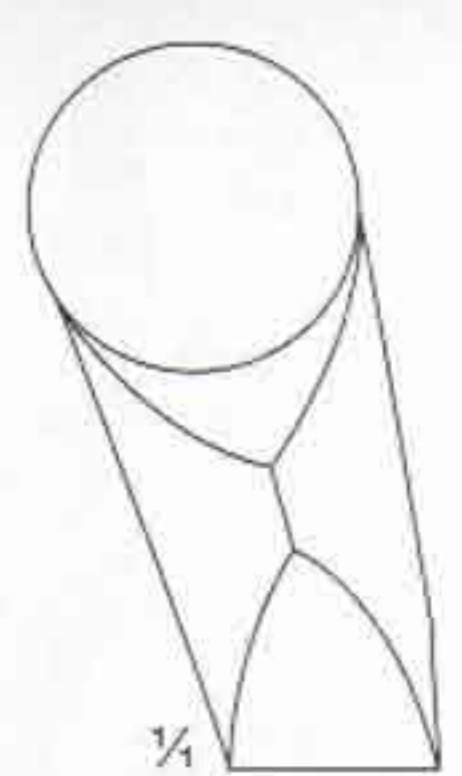
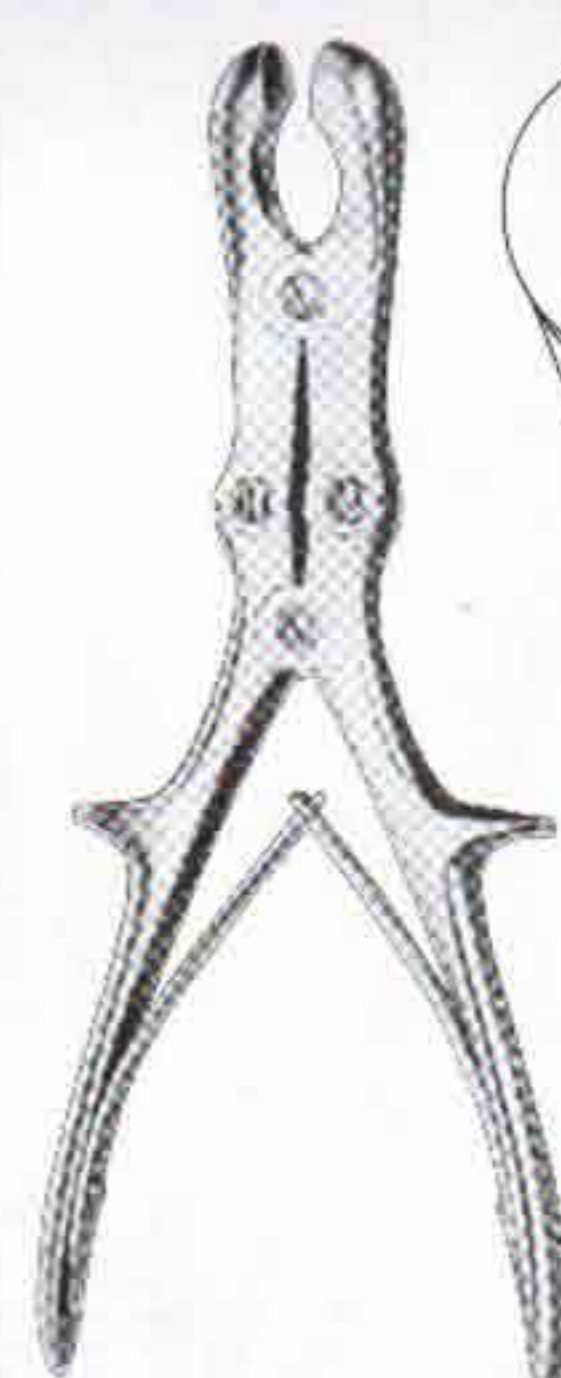

**09-2420**  
22.5 cm, 9"

**BÖHLER**

**BEYER**

**ZAUFAL-JANSEN**

**SEMB**

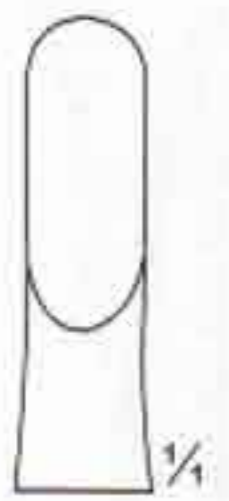

**09-2430**  
23 cm, 9"  
Duckbill  
17 mm x 6 mm

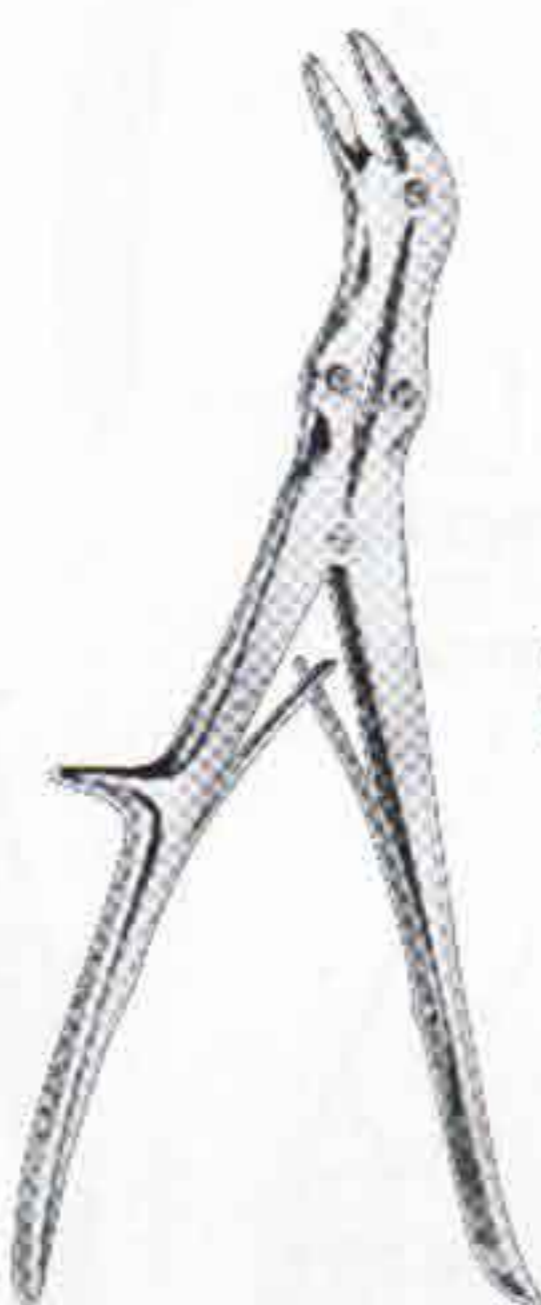

**09-2440**  
2 mm



**09-2441**  
3 mm



**09-2442**  
4 mm



**LEKSELL**  
**09-2450** 3 mm  
**09-2451** 5 mm  
**09-2452** 8 mm  
22 cm, 8 3/4"

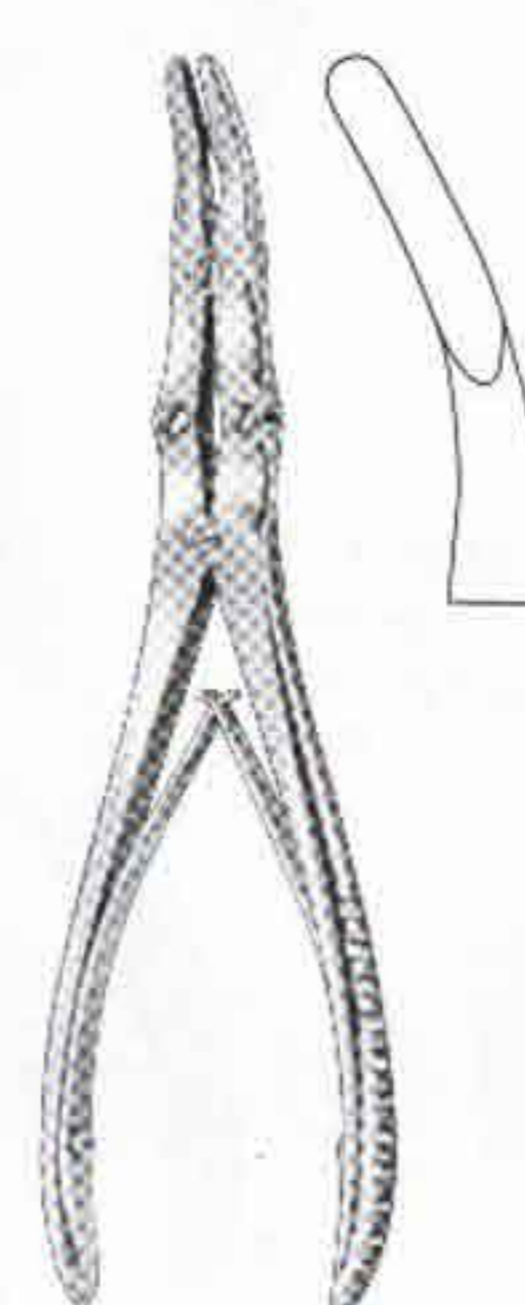

**MAYFIELD**  
**09-2460**  
17 cm, 6 3/4"



**RUSKIN RONGEUR**  
**09-2470**  
curved

**STILLE**

**ECHLIN**  
23 cm, 9"

**LEKSELL**

**MAYFIELD**

**RUSKIN RONGEUR**

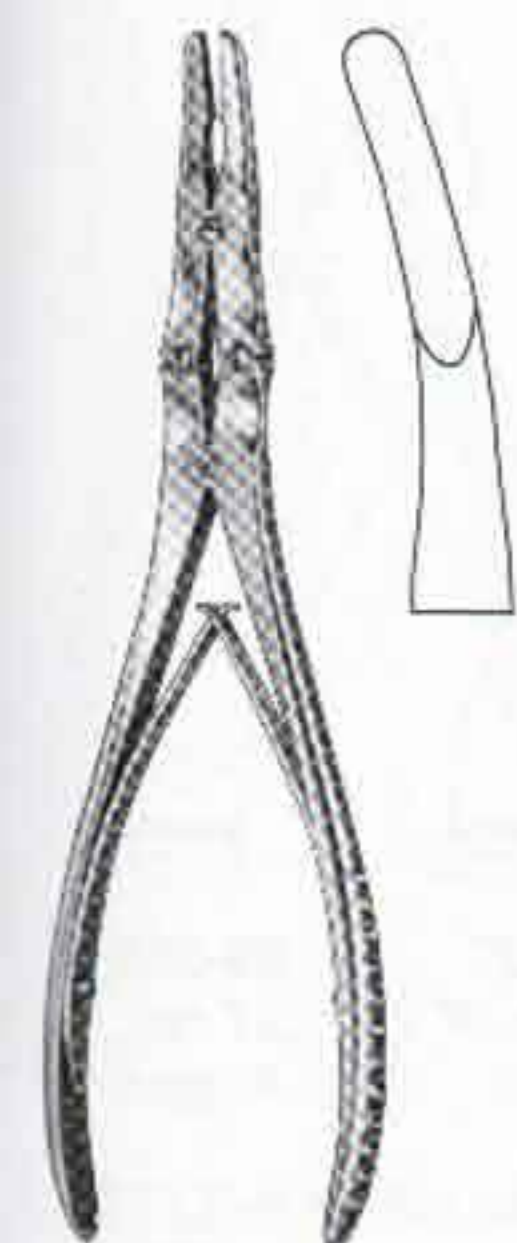

**MARQUARDT**  
**09-2480**  
20 cm, 8"

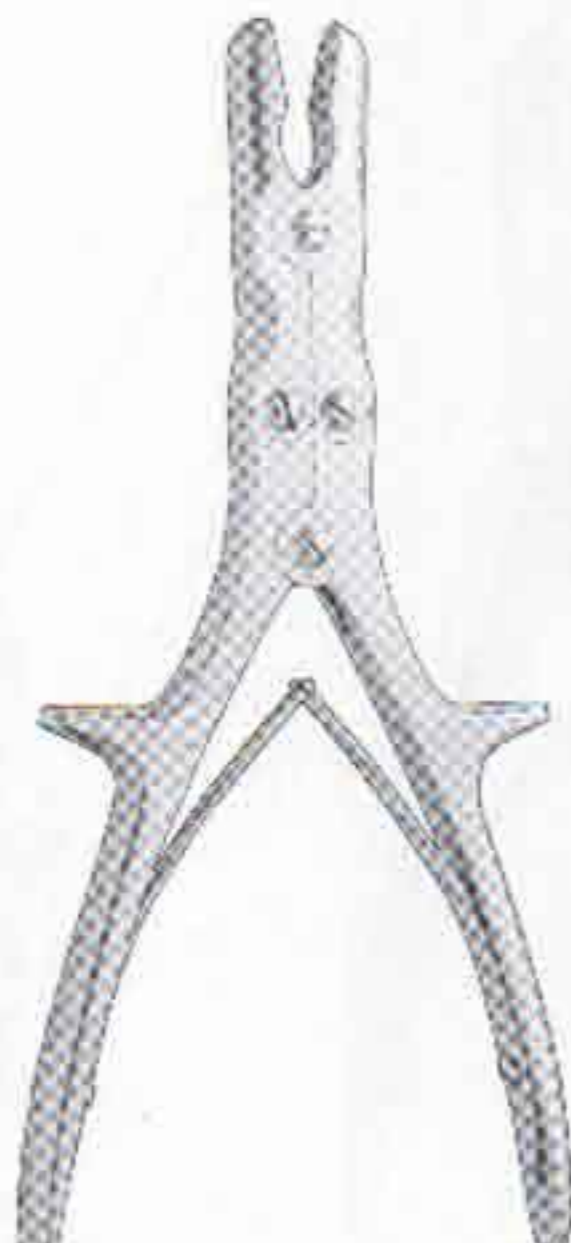

**09-2490**  
23 cm, 9"  
**09-2491**  
27 cm, 10 1/2"  
straight



**09-2492**  
23 cm, 9"  
**09-2493**  
27 cm, 10 1/2"  
curved

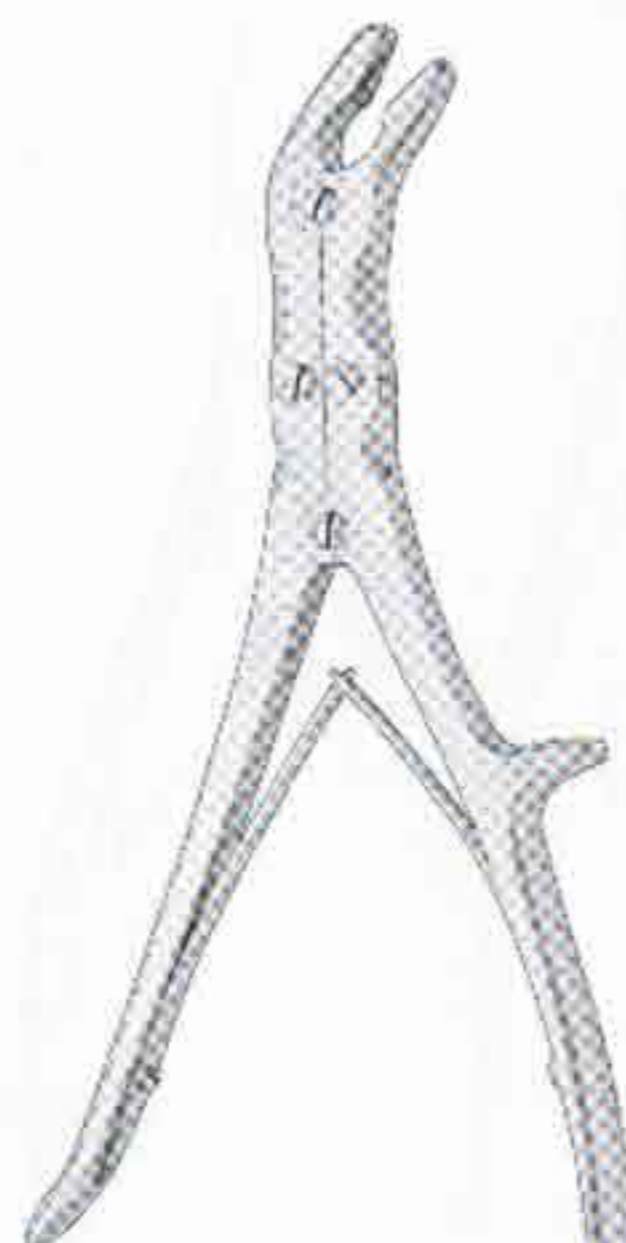

**STILLE RONGEUR**  
**FORCEPS**  
**09-2500**  
23 cm, 9"  
Double-Action  
jaws 3mm wide  
Jaws angled to side

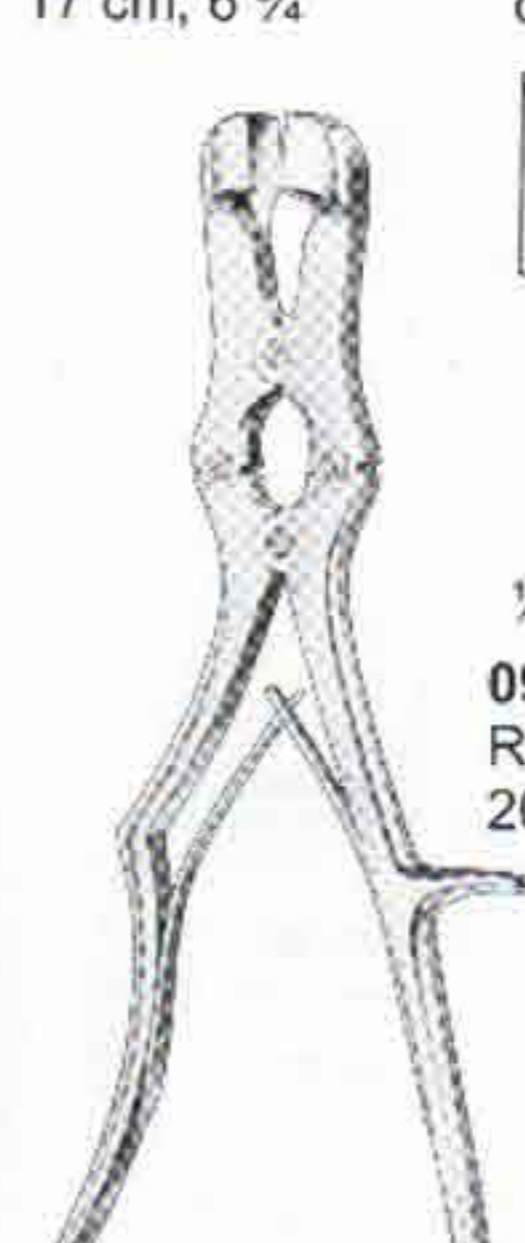

**SAUERBRUCH**  
31 cm, 12 1/4"



**09-2511**  
Straight  
20 mm



# BONE CUTTING FORCEPS

Knochensplitterzangen  
Pinzas cortantes para hueso

Pinces coupantes à os  
Cesoie per ossa

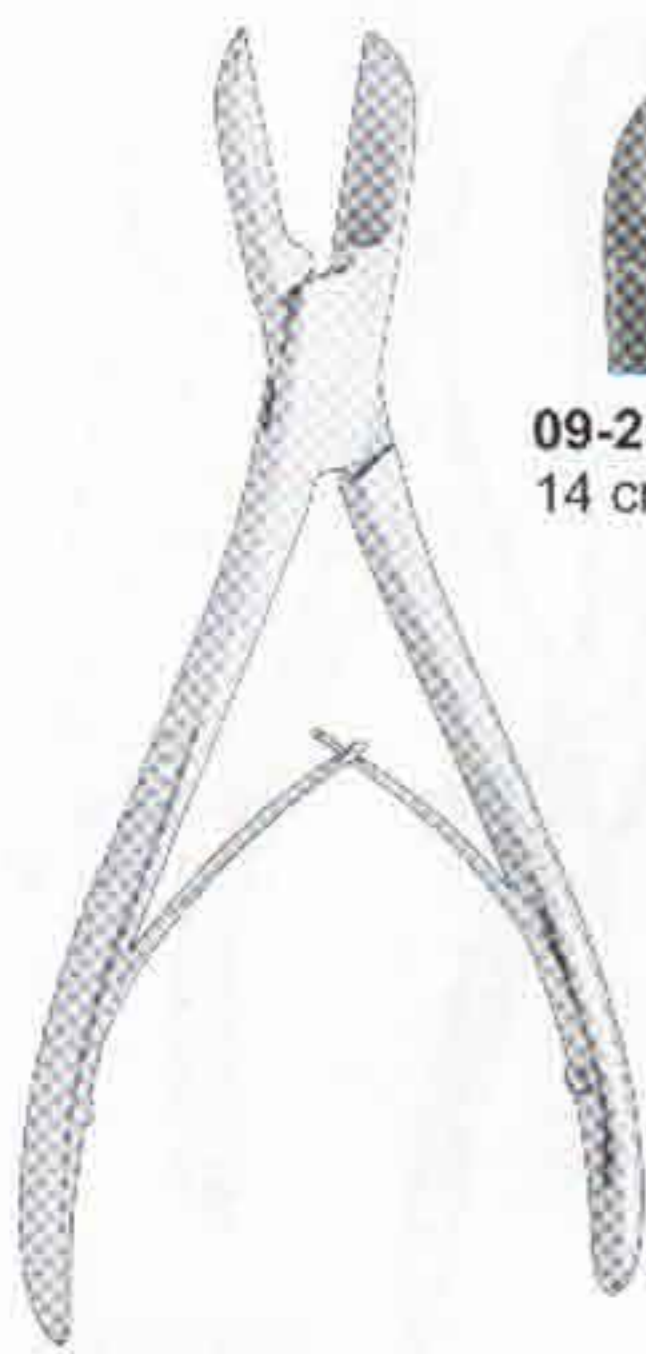

**LISTON BONE  
Cutting Forceps**



**09-2520**  
14 cm, 5 1/2"



**09-2521**  
17 cm, 6 3/4"



**09-2522**  
19 cm, 7 1/2"  
**09-2523**  
22 cm, 8 3/4"

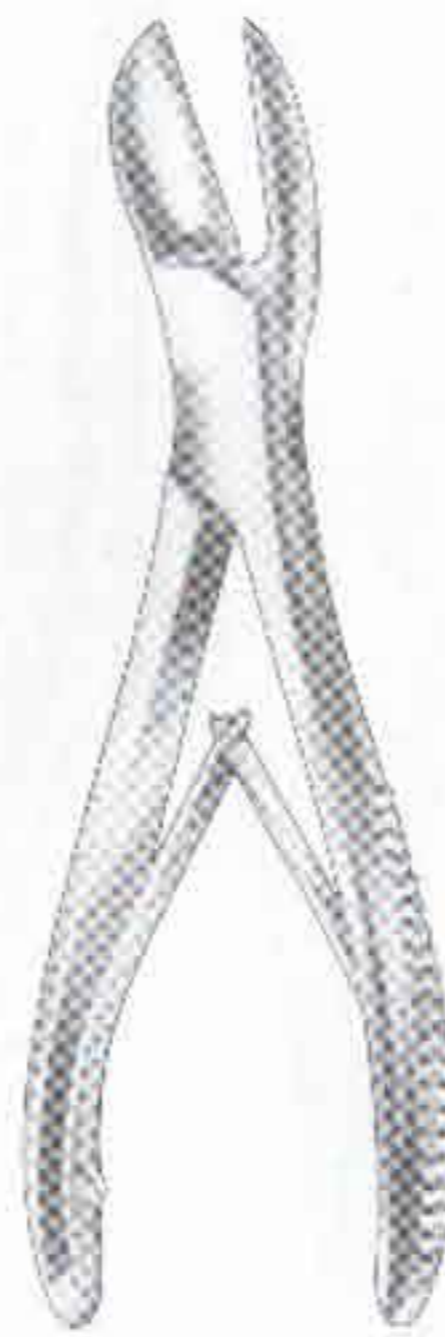

**LISTON**



**09-2530**  
14 cm, 5 1/2"



**09-2531**  
17 cm, 6 3/4"



**09-2532**  
19 cm, 7 1/2"



**09-2533**  
22 cm, 8 3/4"



**MARKWALDER**



**09-2540**  
20 cm, 8"

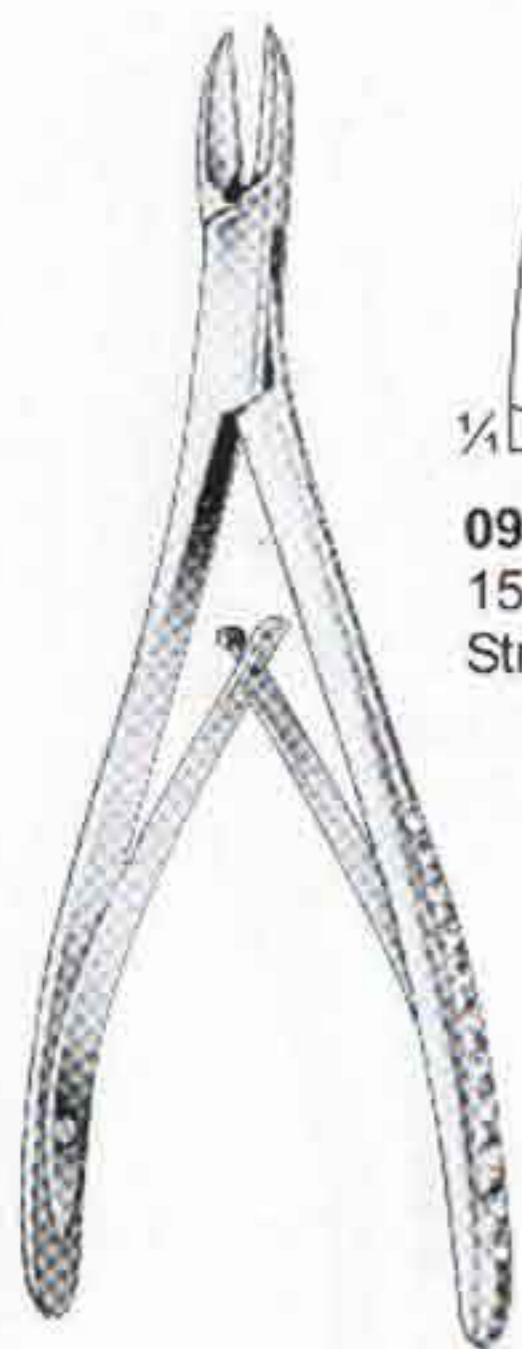

**LITTAUER / LISTON**



**09-2550**  
15 cm, 6"  
Straight,

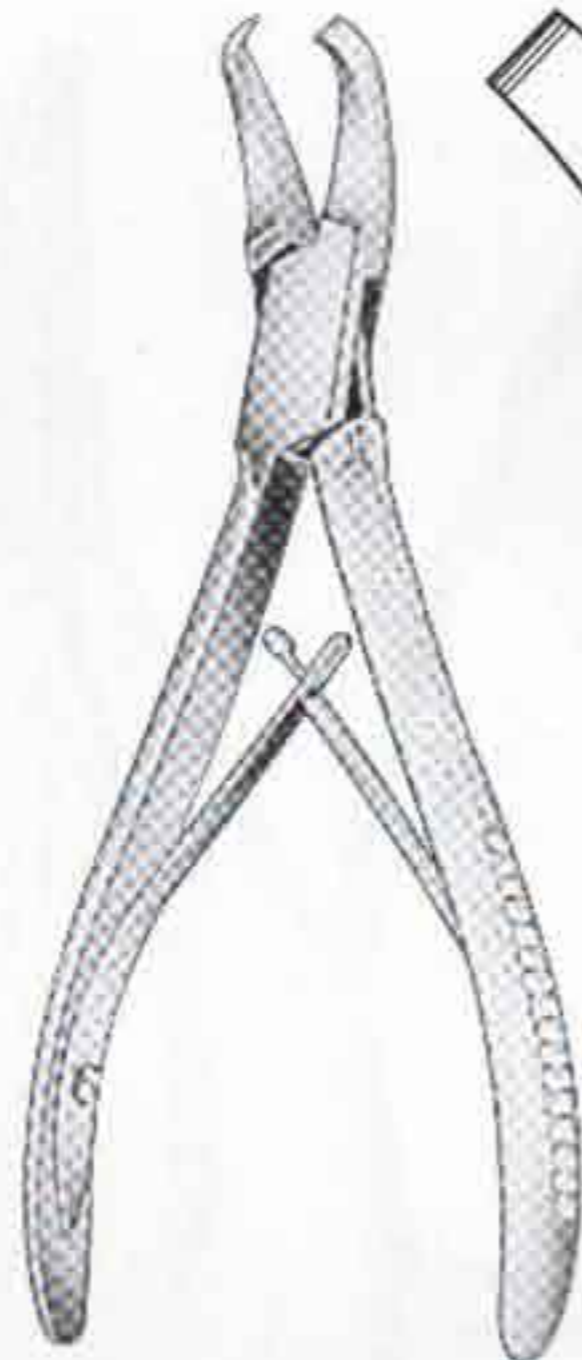

**CLEVELAND-GARDNER**

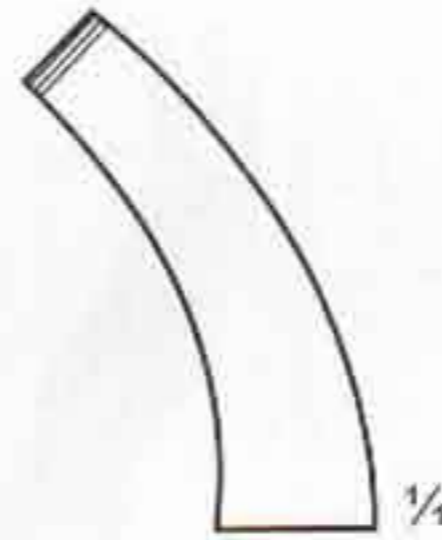

**09-2560**  
16 cm, 6 1/2"



**WALTON-LISTON**



**09-2570**  
15 cm, 6"  
Straight



**09-2571**  
15 cm, 6"  
Angled

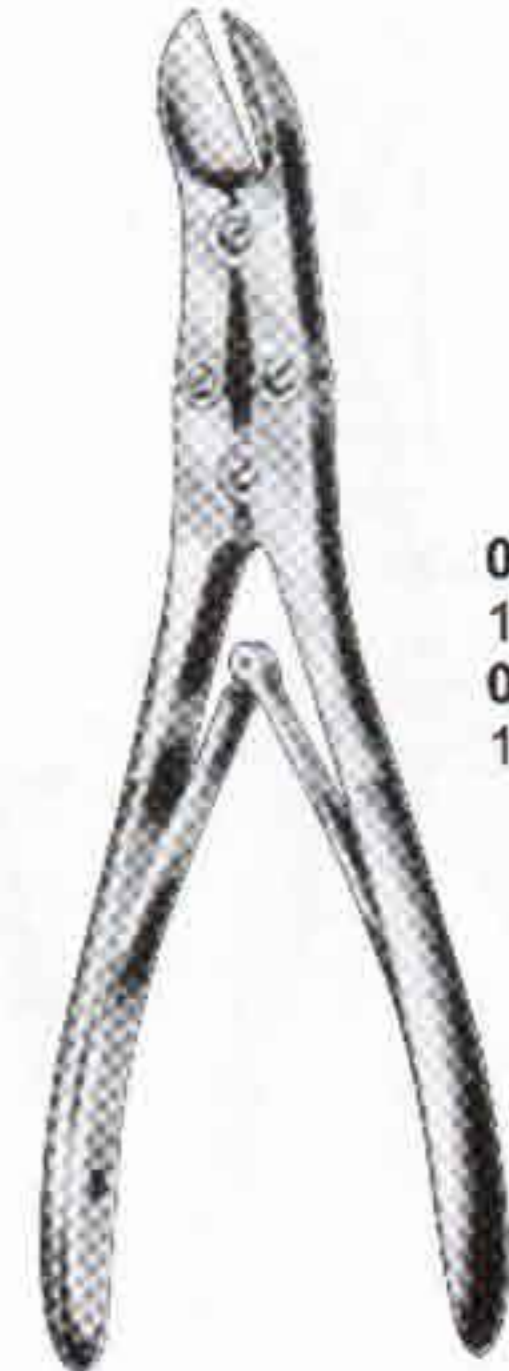

**RUSKIN-LISTON**



**09-2580**  
19 cm, 7 1/2" Straight  
**09-2581**  
19 cm, 7 1/2" Curved

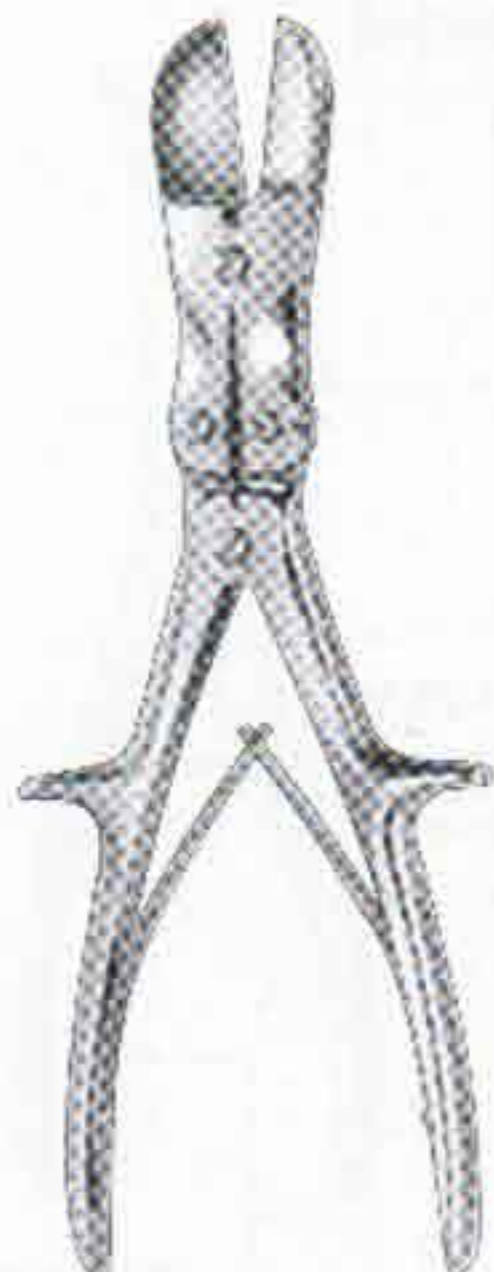

**STILLE-LISTO**

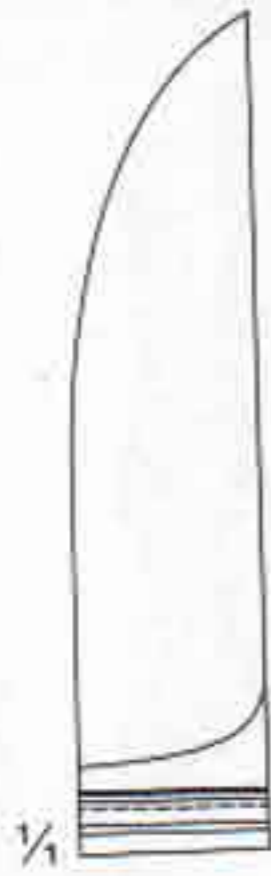

**09-2590**  
27 cm, 10 1/2"  
Straight

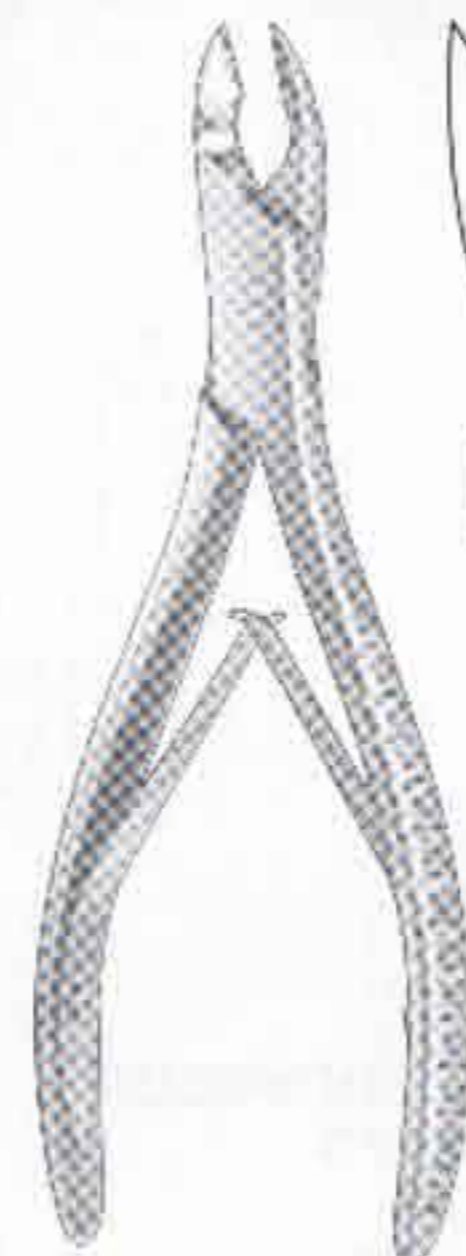

**CLEVELAND**  
**09-2600**  
17 cm, 6 3/4"

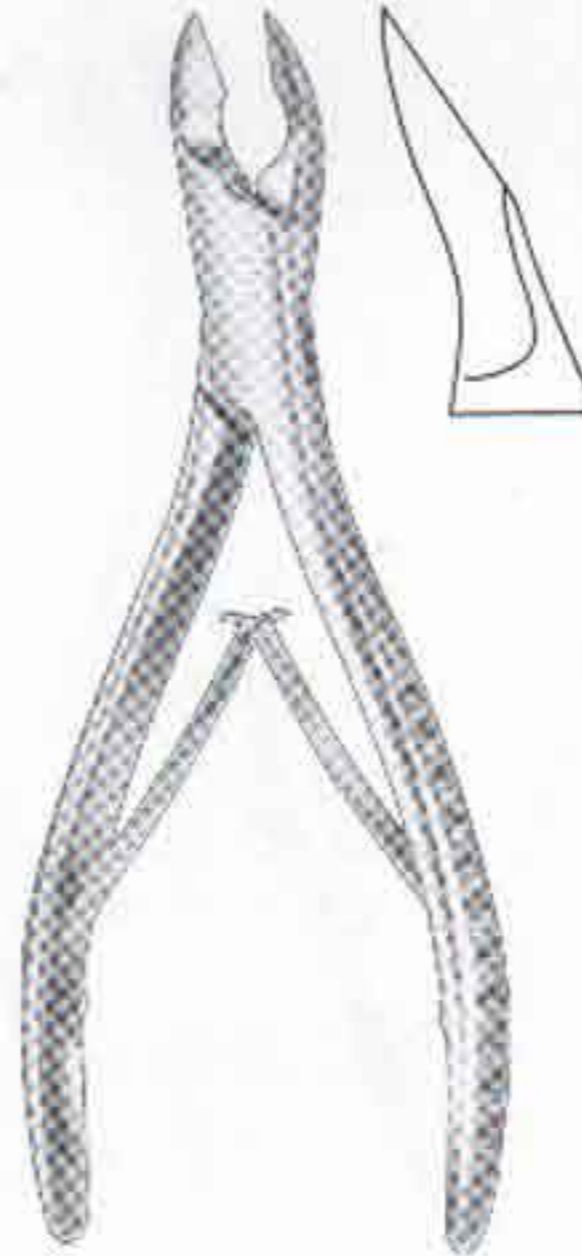

**CLEVELAND**  
**09-2610**  
15 cm, 6"

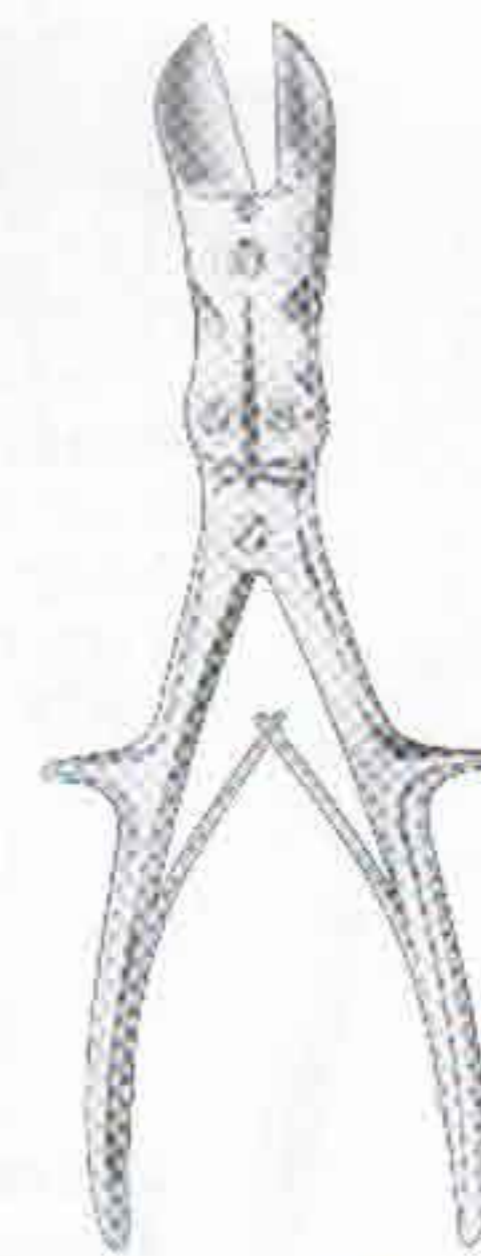

**LISTON**



**09-2620**  
23 cm, 9"  
Angled



**09-2621**  
27 cm, 10"  
Angled



# BONE CUTTING FORCEPS

Knochensplitterzangen  
Pinzas cortantes para hueso

Pinces coupantes à os  
Cesoie per ossa

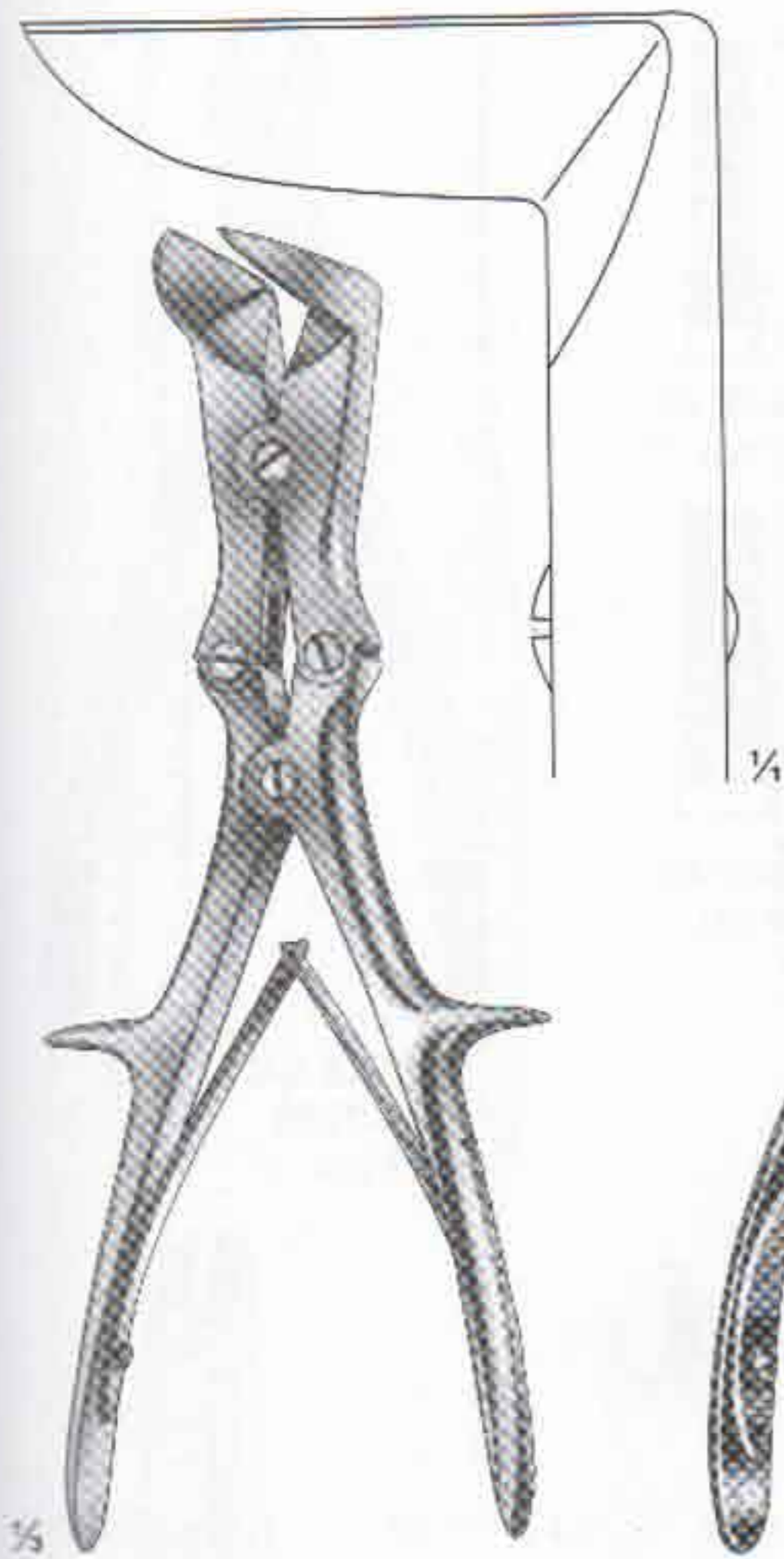

**LISTON-STILLE**  
09-2630  
26 cm, 10 1/4"

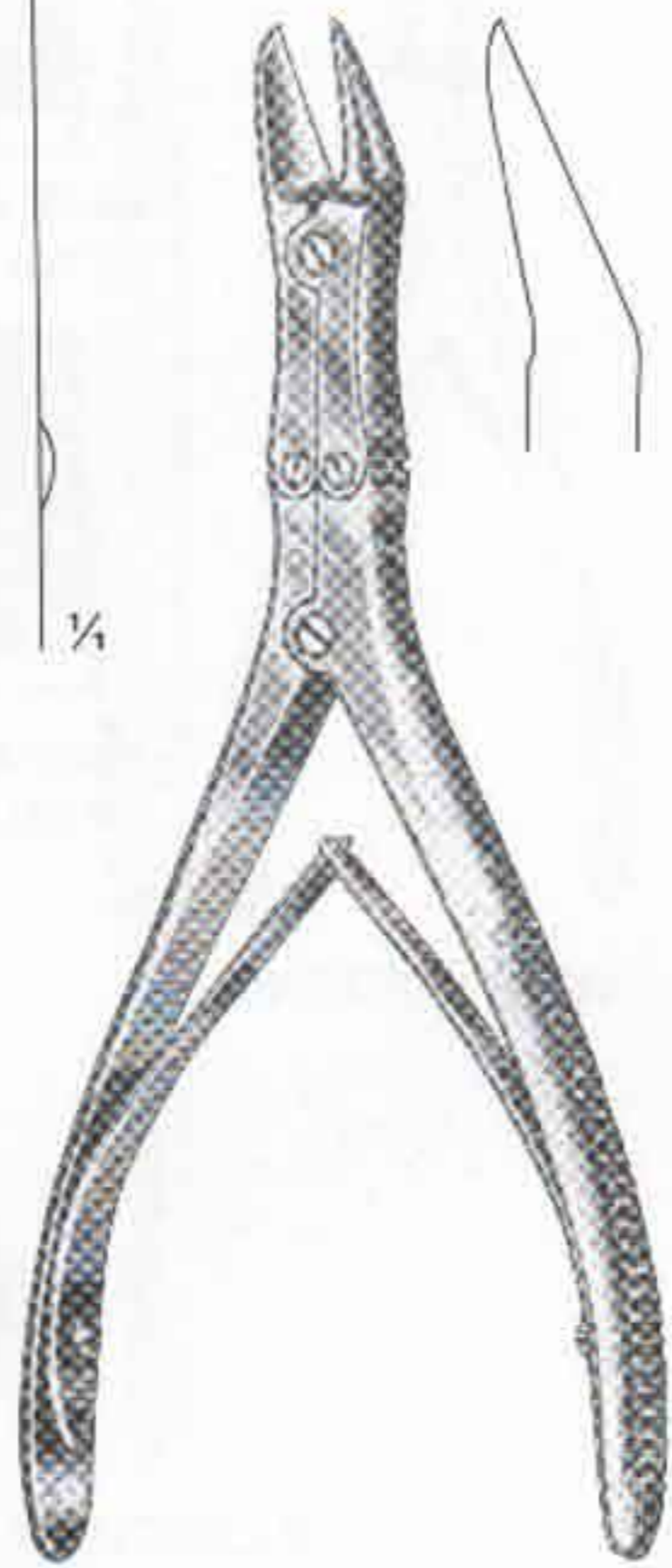

**Mc INDOE**  
09-2640  
17.5 cm, 7"

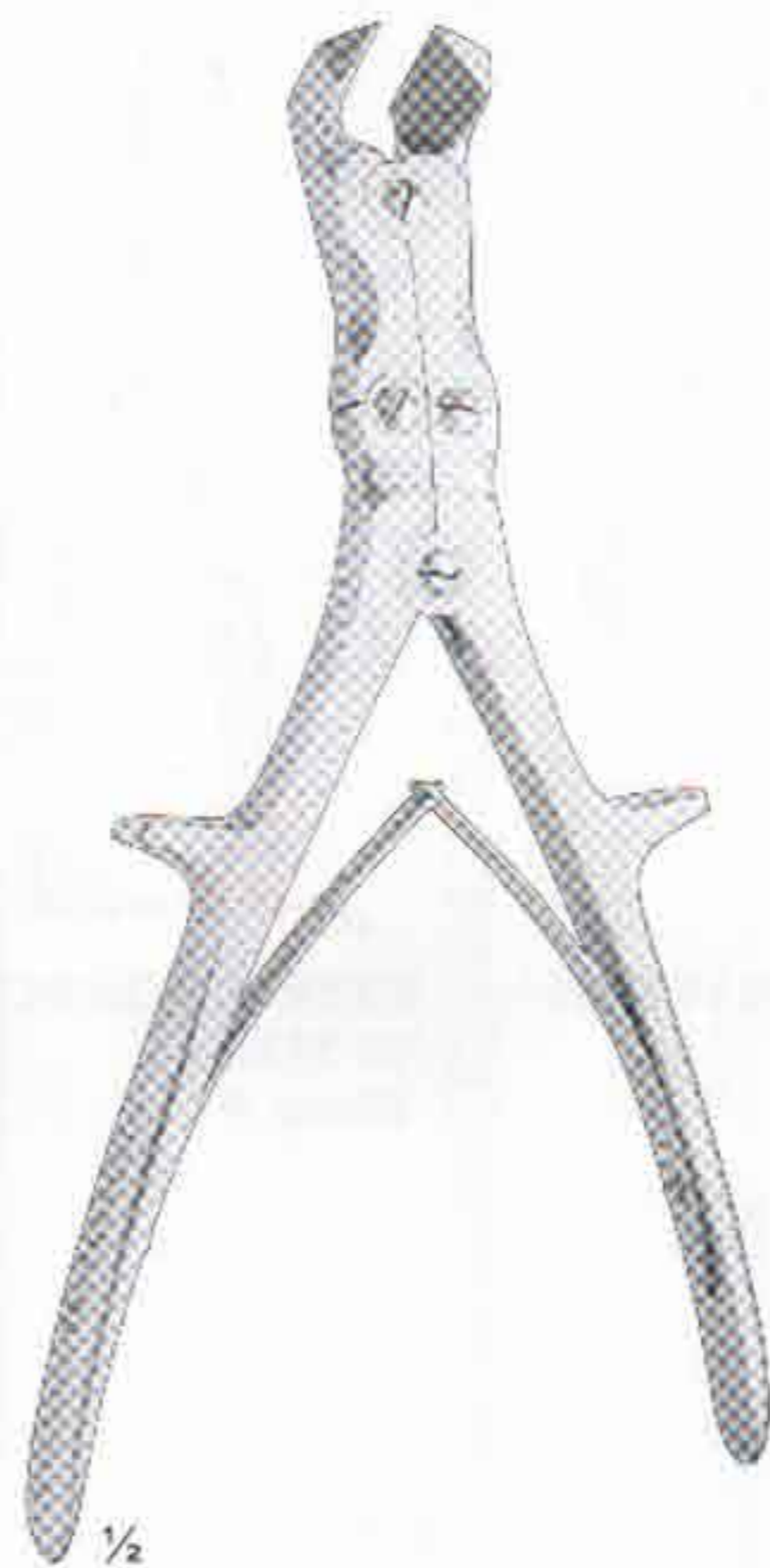

**HORSLEY**  
Bone Cutting Forceps  
09-2650  
25 cm, 10"

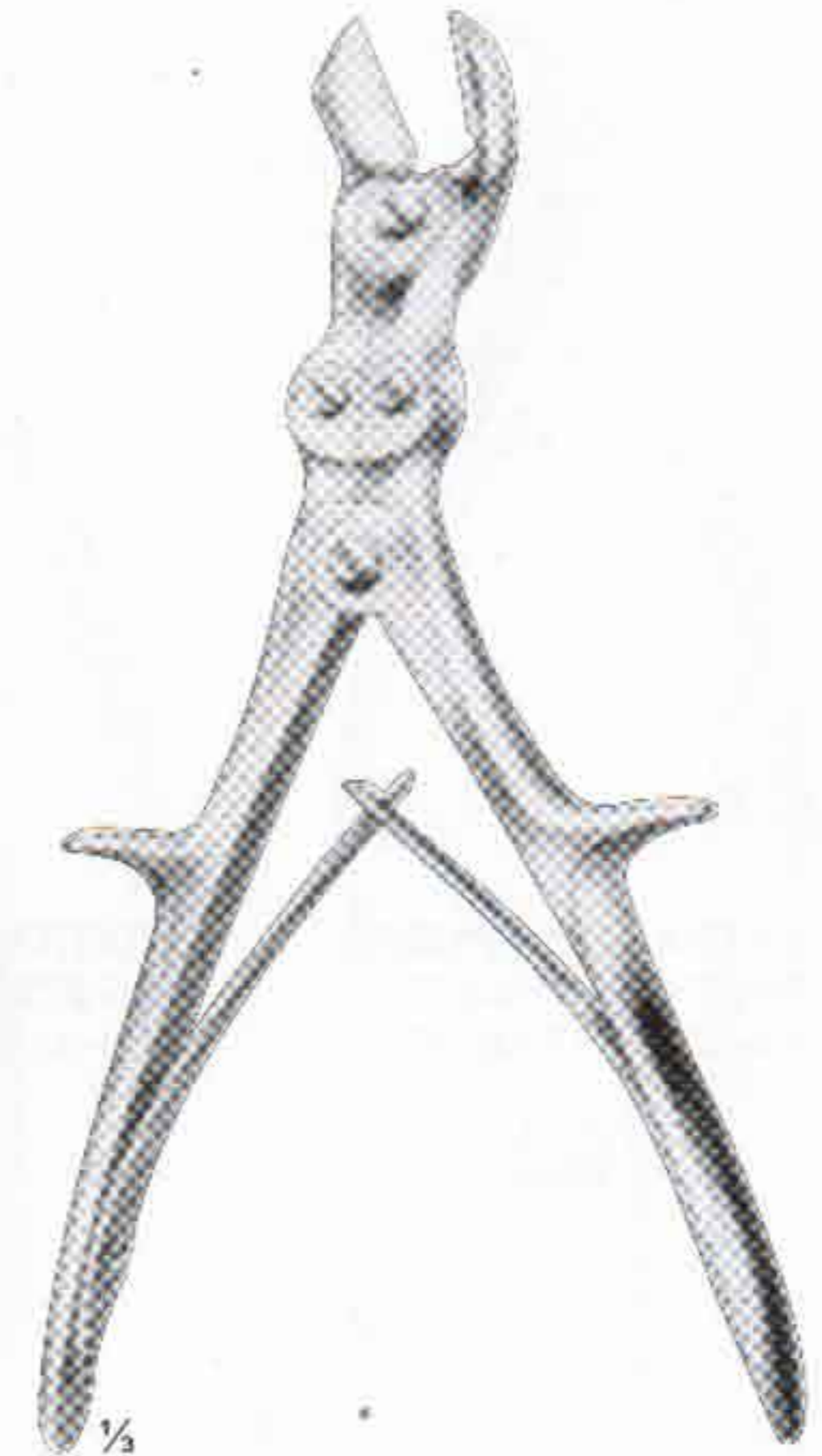

**LISTON-KEY (HORSLEY)**  
09-2660  
26.5 cm, 10 1/2"  
Angled, 28 mm

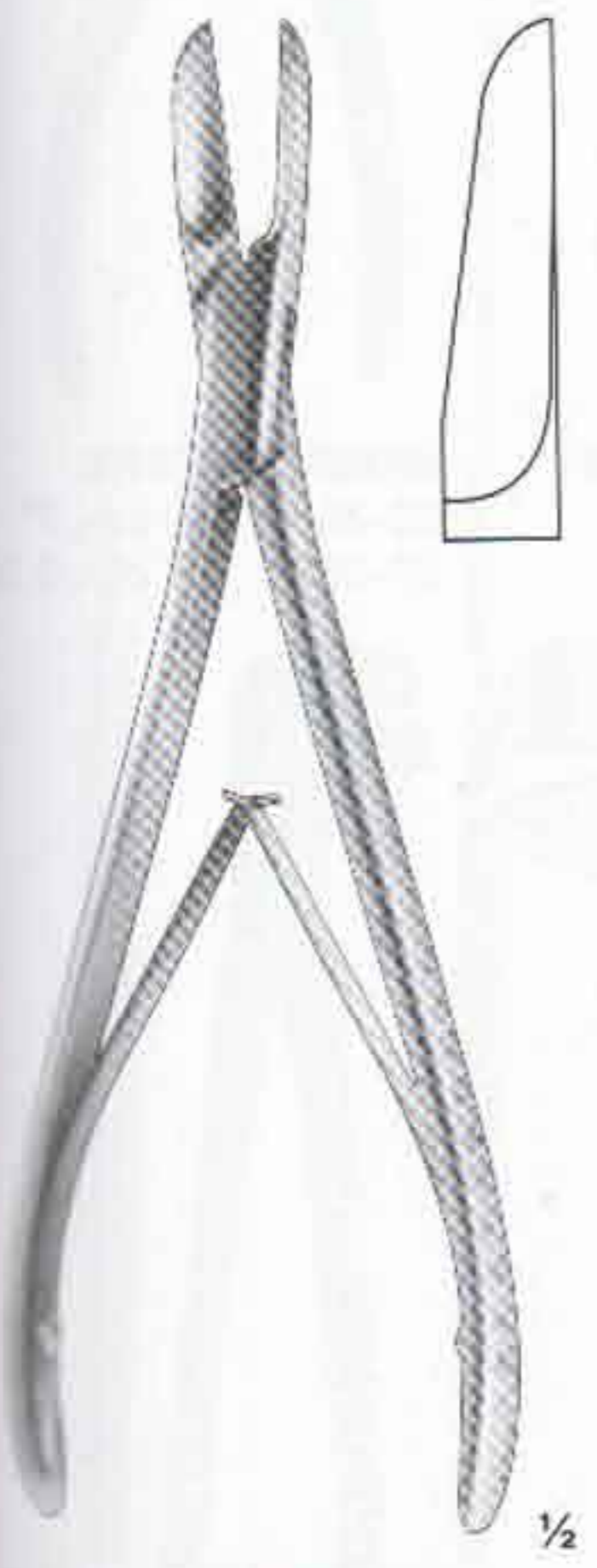

**COTTLE-KAZANJIAN**  
09-2670  
19 cm, 7 1/2"

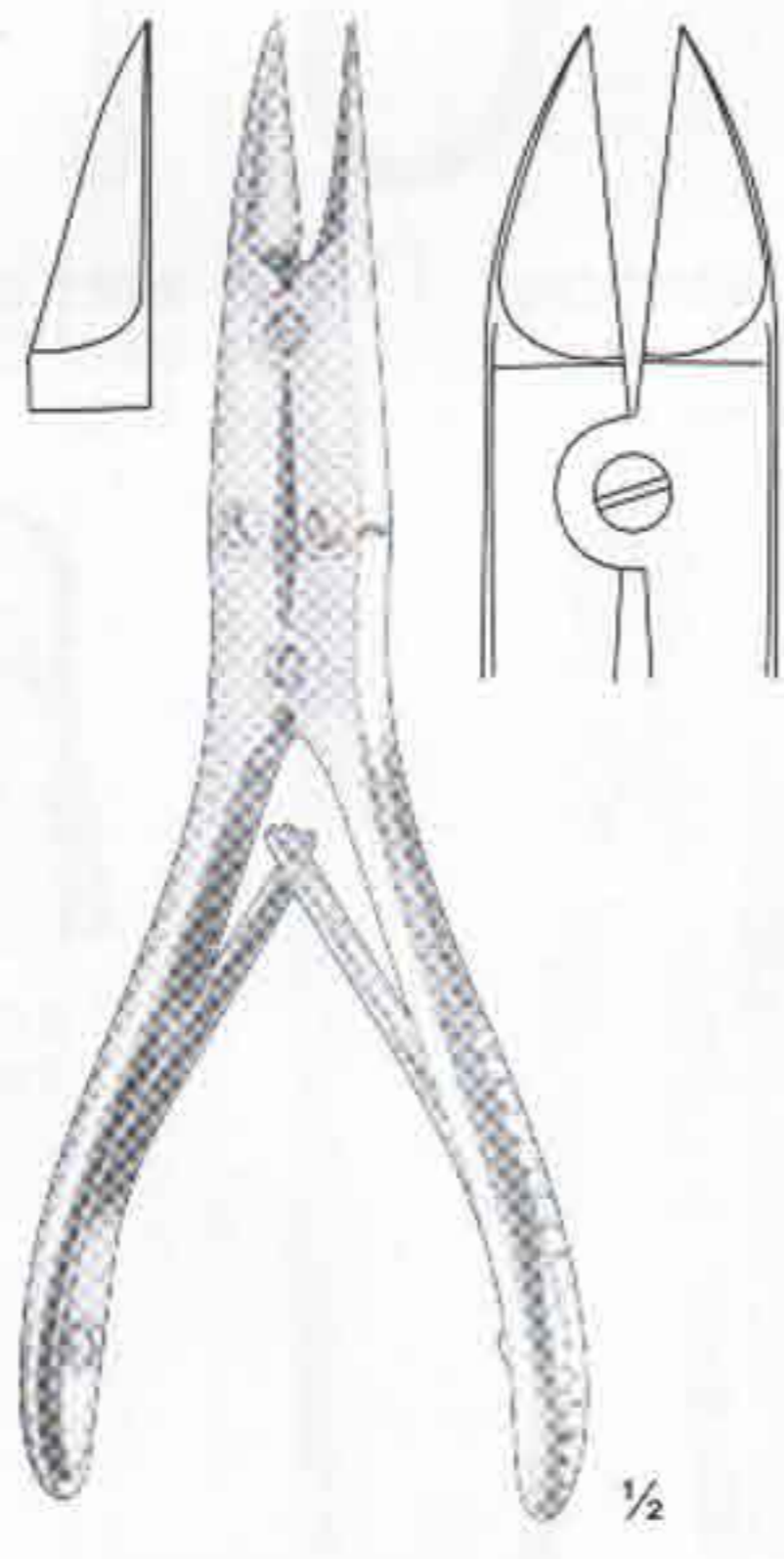

**09-2680**  
15 cm, 5 3/4"

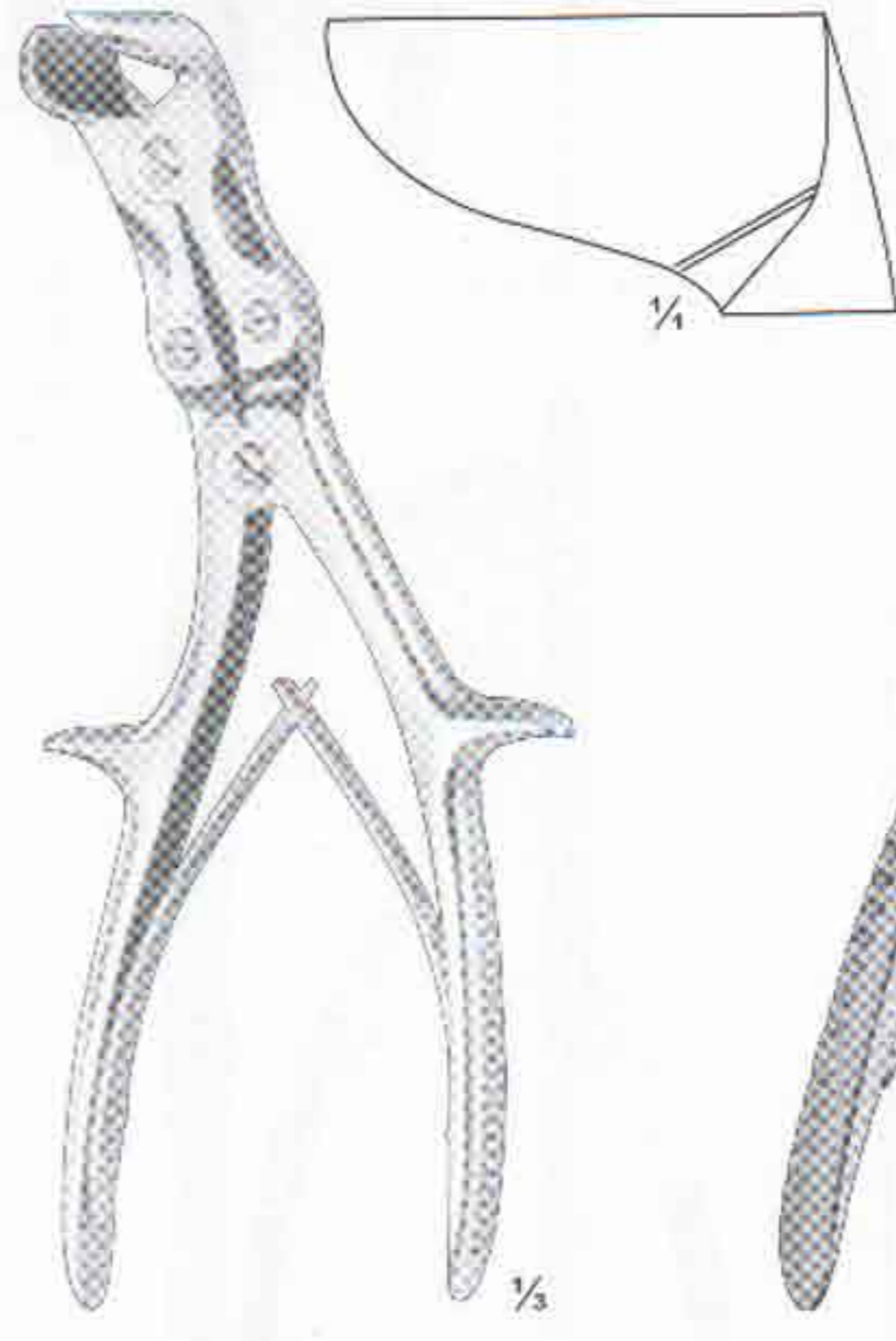

**SEMB**  
09-2690  
24 cm, 9 1/2"

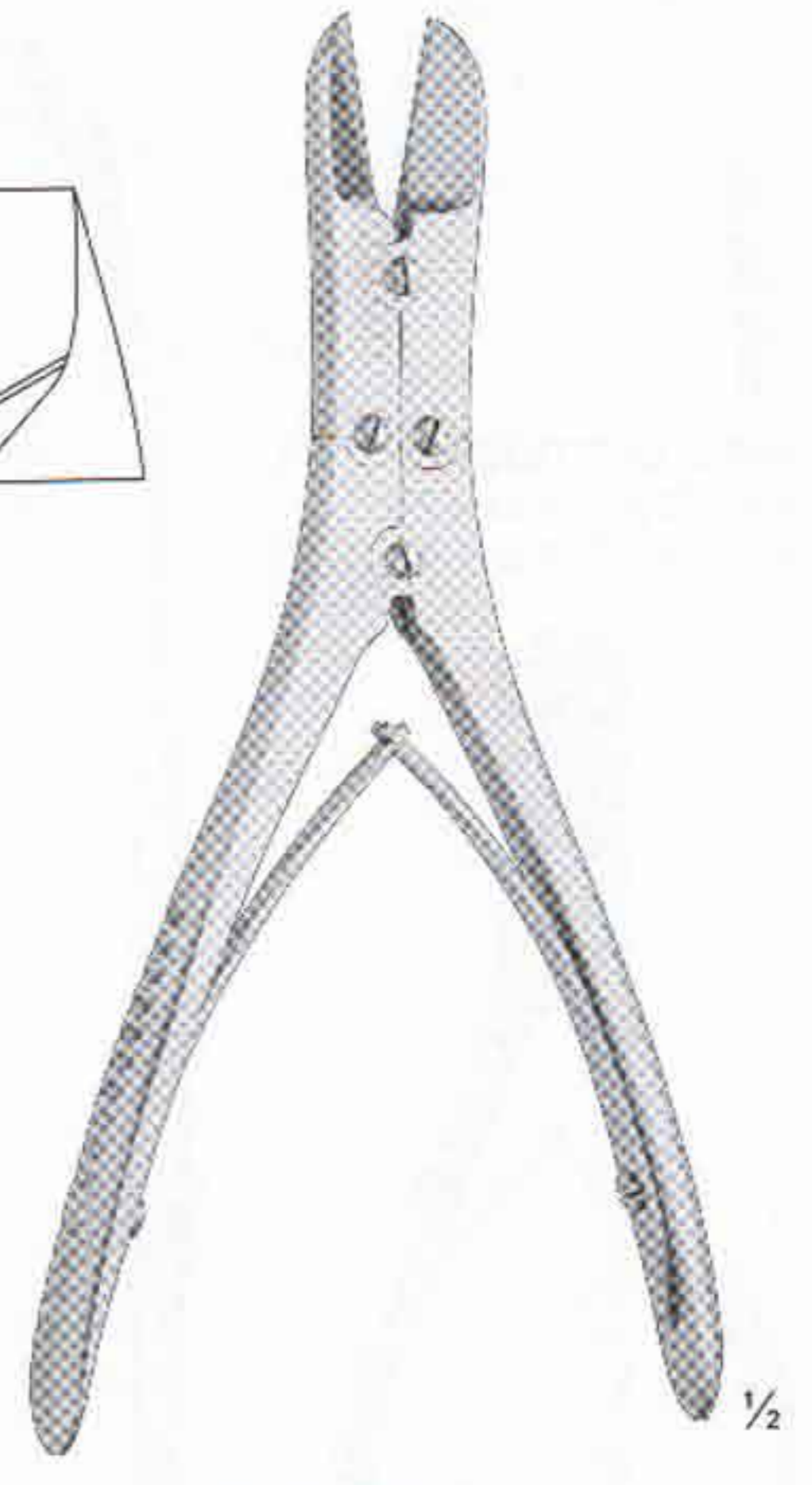

**RUSKIN BONE SPLITTING FORCEPS**  
09-2700  
20 cm, 8", Double-Action



# FLAT NOSE PLIERS & WIRE CUTTING PLIERS T.C. INSERTED

*Pinces plates, Alicates planos, Flachzangen.*

*Pinces coupantes, Alicates para cortar alambre, Drahtkneifzangen*



**EXTRACTION PLIERS**  
09-2710 18 cm, 7"  
09-2711 18 cm, 7"



**EXTRACTION PLIERS**  
09-2720  
20 cm, 8"

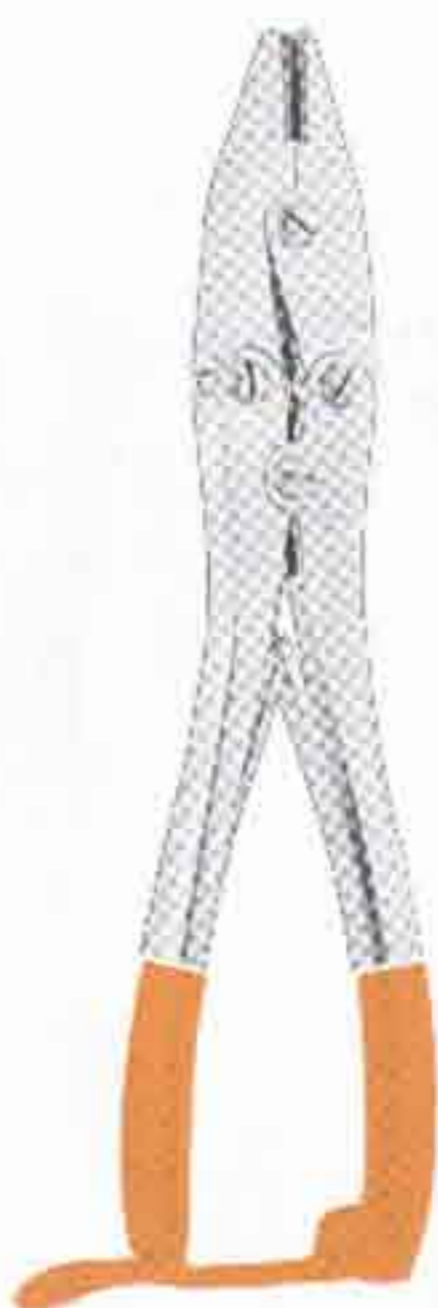

**EXTRACTION PLIERS**  
09-2730  
20 cm, 8"

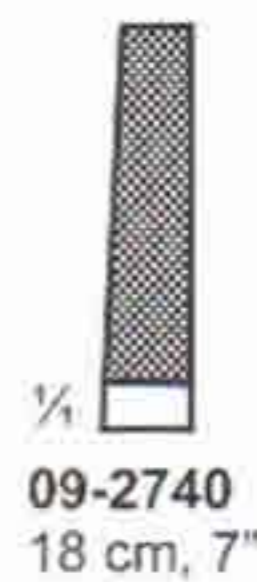
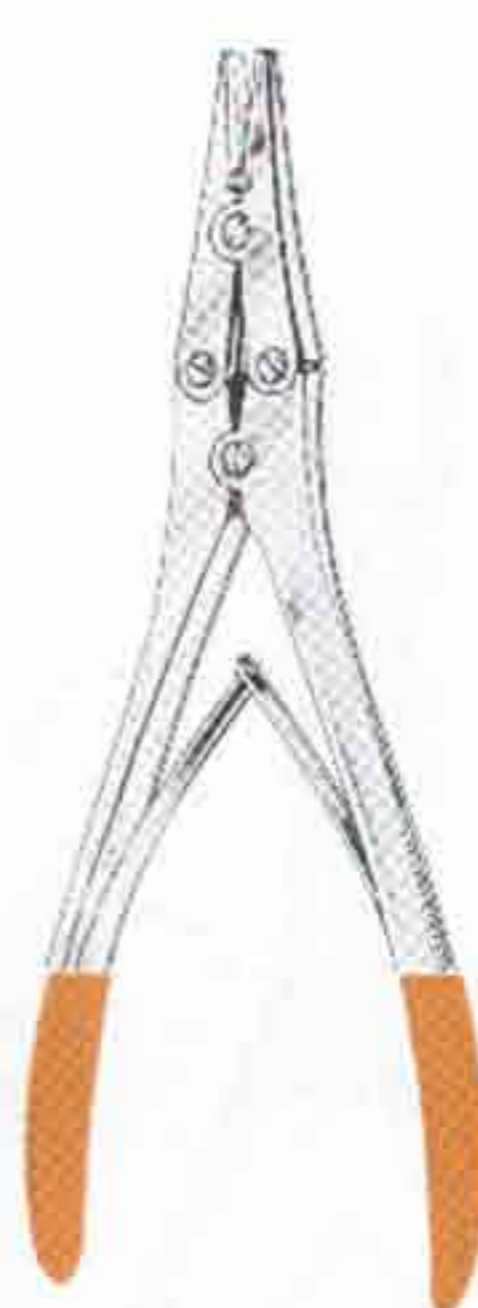

**WIRE CUTTERS**

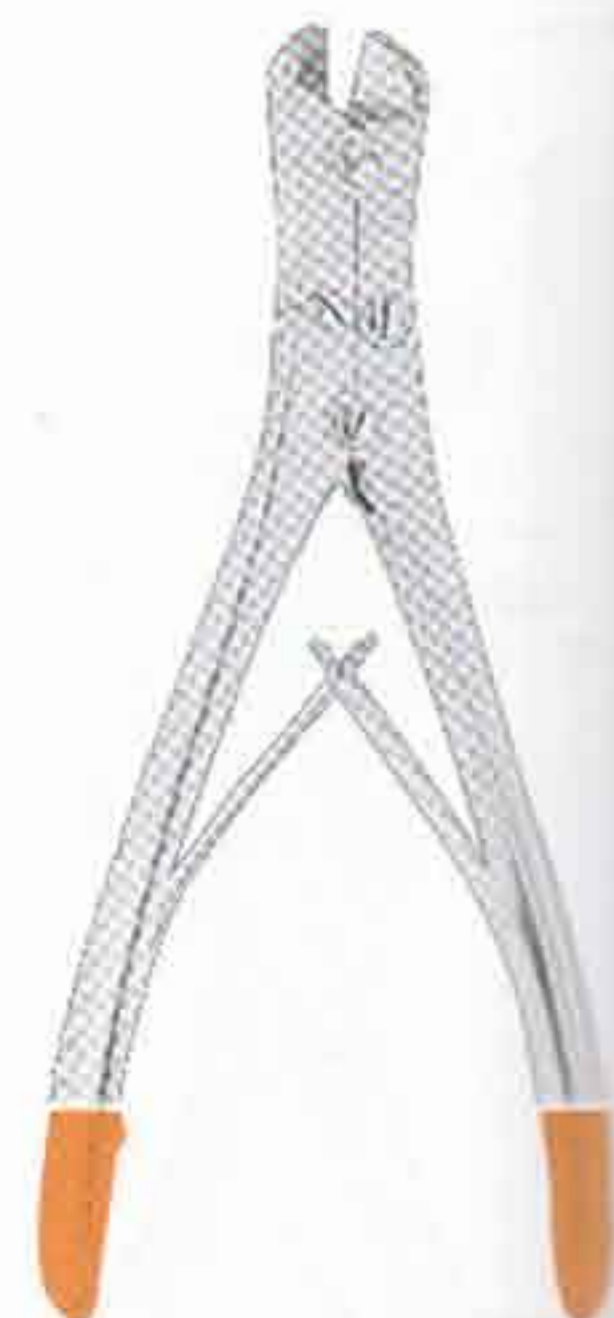

**WIRE CUTTERS**  
09-2750  
18 cm, 7"

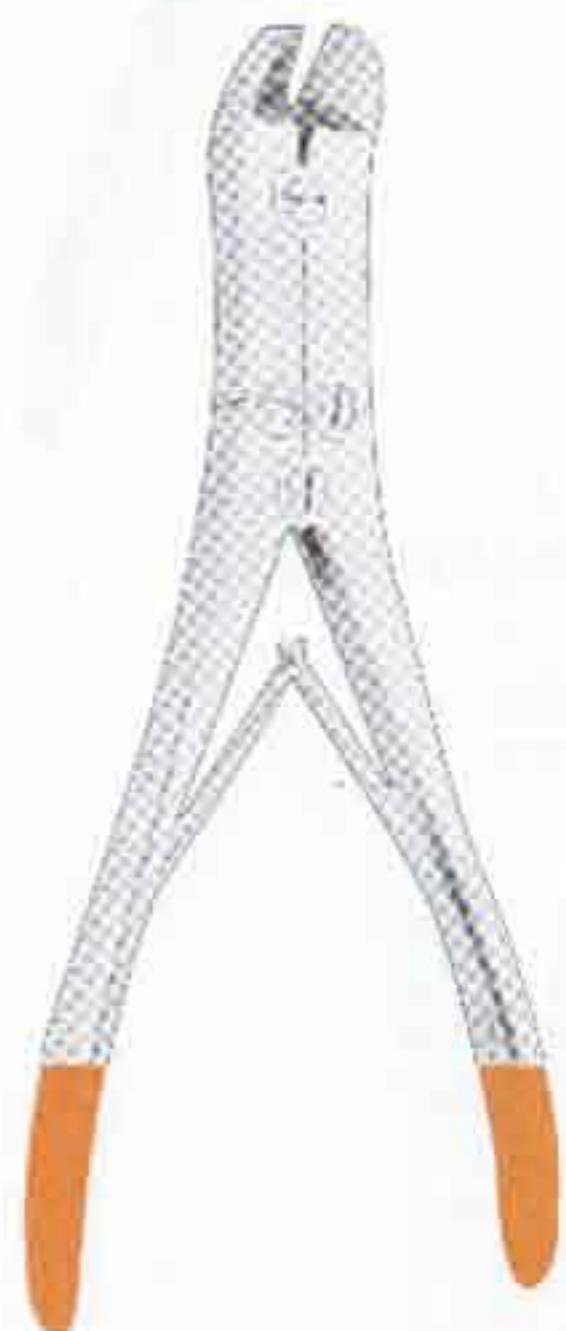

**WIRE CUTTERS**  
09-2760 18 cm, 7"  
09-2761 21 cm, 8 1/4"

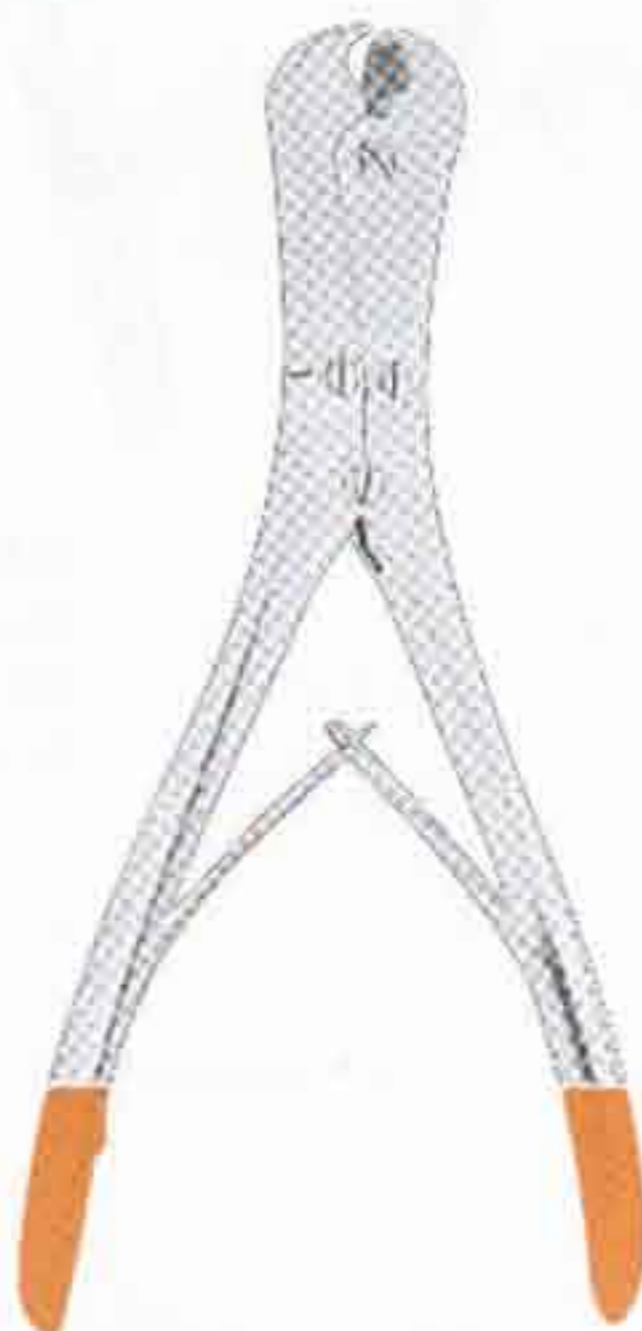

**WIRE CUTTERS**  
09-2770  
18 cm, 7"



**UNIVERSAL SCISSORS**  
09-2780 10 cm, 4"  
09-2781 12 cm, 5"



**WIRE CUTTER**  
09-2790  
18 cm, 7"



**WIRE CUTTERS**  
09-2800 18 cm, 7"  
09-2801 21 cm, 8 1/4"

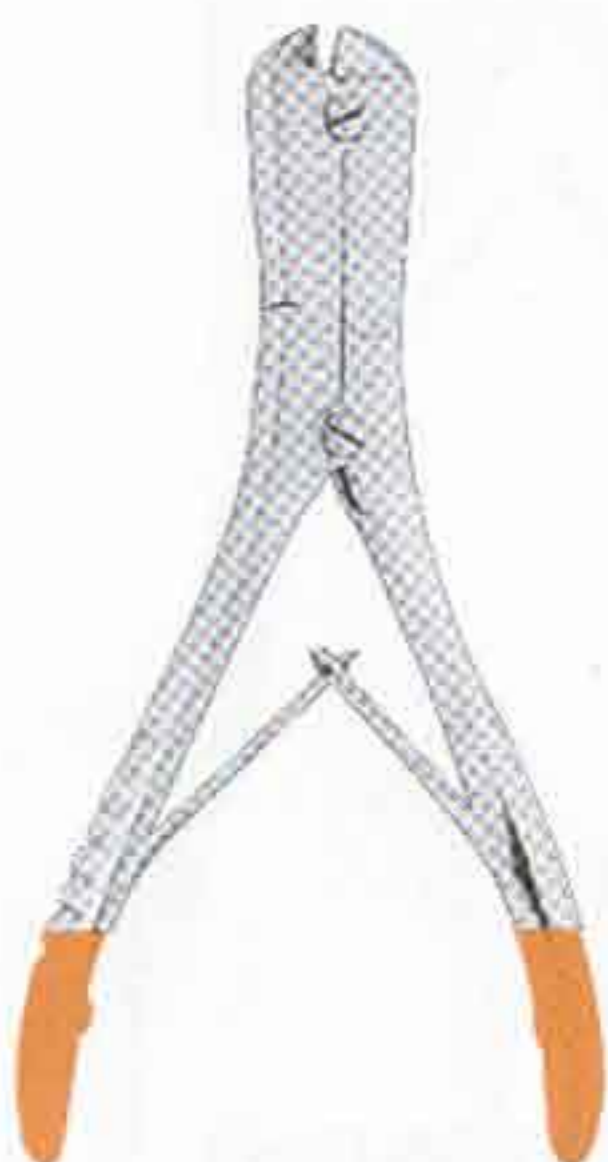

**WIRE CUTTERS**  
09-2810  
14 cm, 5 1/2"

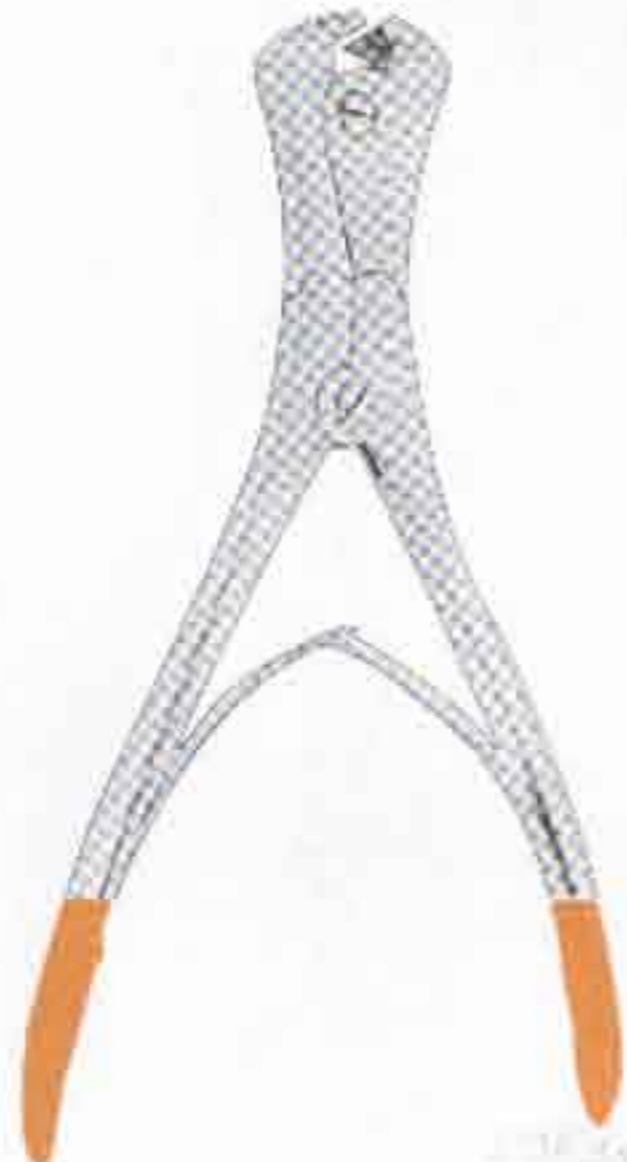

**WIRE CUTTERS**  
09-2820  
22 cm, 8 3/4"



**WIRE CUTTERS**  
09-2830 46 cm, 18"  
09-2831 56 cm, 22"



**09-2840**  
24 cm, 9 1/2"



# DURA HOOKS / NERVE HOOKS



Duramesser, Durahaken,  
Durahaken, Nerv-und Gefäßhäkchen

Couteaux Pour Dure-mere, Crochets Pour Dure-mère,  
Crochets Pour Dure-mère, Crochets à Nerfs Et à Vaisseaux

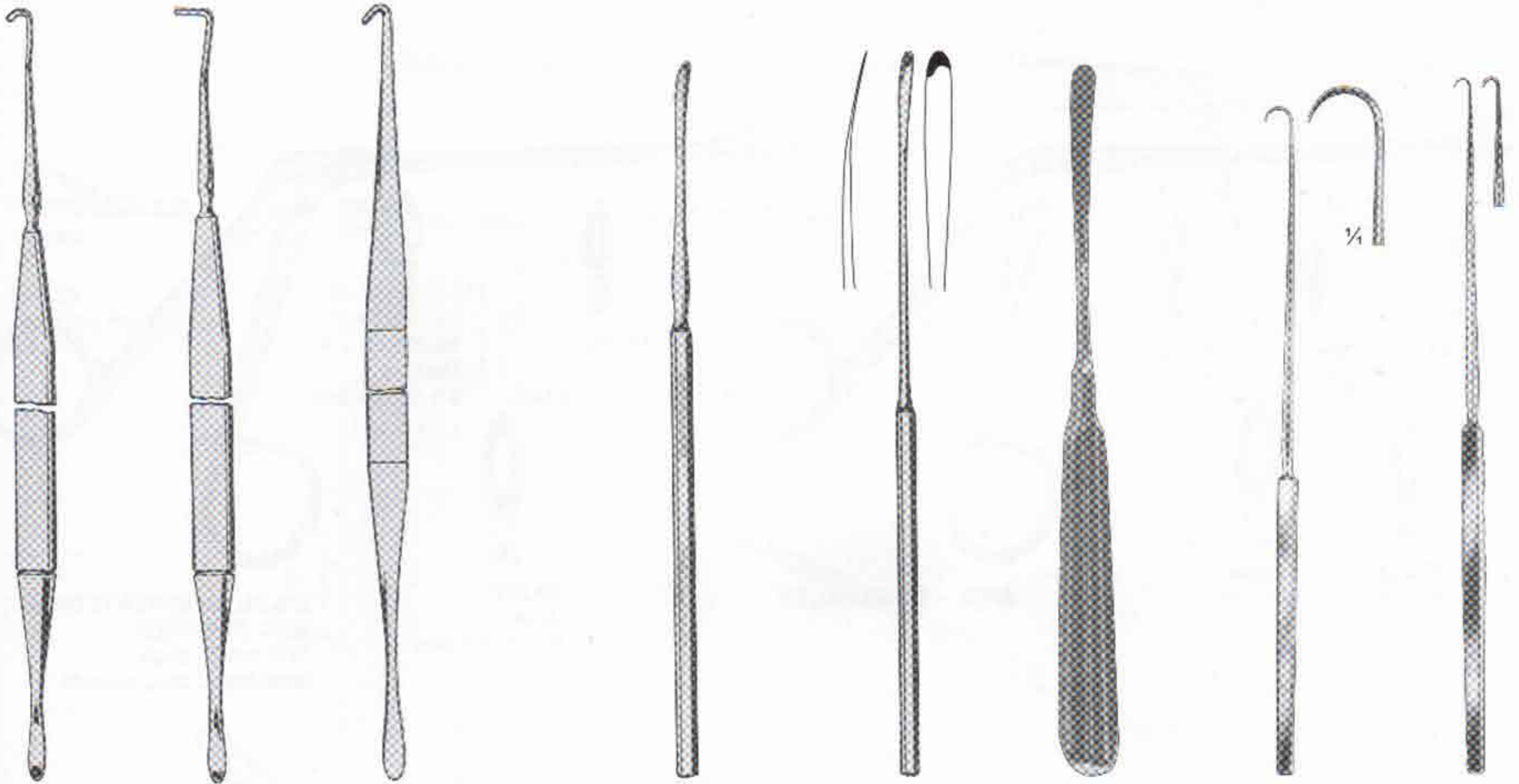

**SCOVILLE**  
**10-100**  
30 cm, 12"  
Nerve Hook and  
Dissector

**SCOVILLE**  
**10-110**  
30 cm, 12"  
Nerve Hook and  
Dissector

**SCOVILLE**  
**10-120**  
30 cm, 12"  
Sympathectomy Hook  
and Dissector

**10-130**  
Davis  
4 mm, 19 cm, 7 1/2"

**10-140**  
Sachs  
3 mm, 20 cm, 8"

**10-150**  
Sachs  
6 mm, 20 cm, 8"

**GRAHAM**  
**10-160**  
16.5cm

**SACHS**  
**10-170**  
16.5cm

## NERVE SEPARATOR & SPATULA

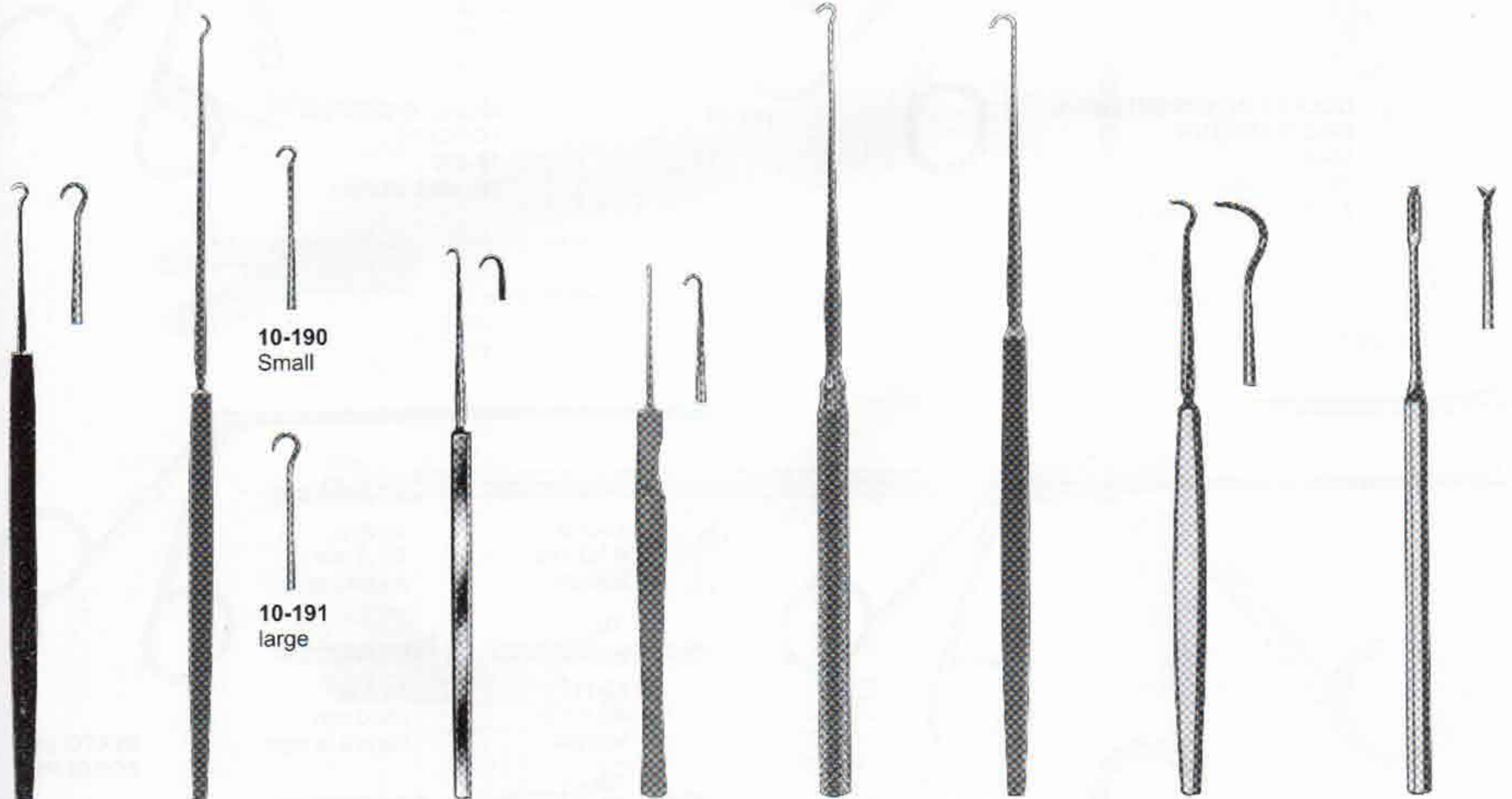

**FRAZIER**  
**10-180**  
12.5 cm, 5"

**GILLIES**  
19 cm, 7 1/2"

**10-190**  
Small

**10-191**  
large

**10-200**  
Straight  
13 cm, 5"

**LAHEY CLINIC**  
**10-210**  
13 cm, 5"

**SACHS**  
**10-220**  
18.5 cm, 7 1/4"

**10-230**  
16 cm, 6 1/2"

**TOENNIS**  
**10-240**  
15 cm, 6"

**DURA**  
**TWIST HOOK**  
**10-250**  
14 cm, 5 1/2"



# LAMINECTOMY RONGEURS

Laminektomieztangen  
Pinzas Para Laminectomia

Pinces Pour Laminectomie  
Pinze Per Laminectomia

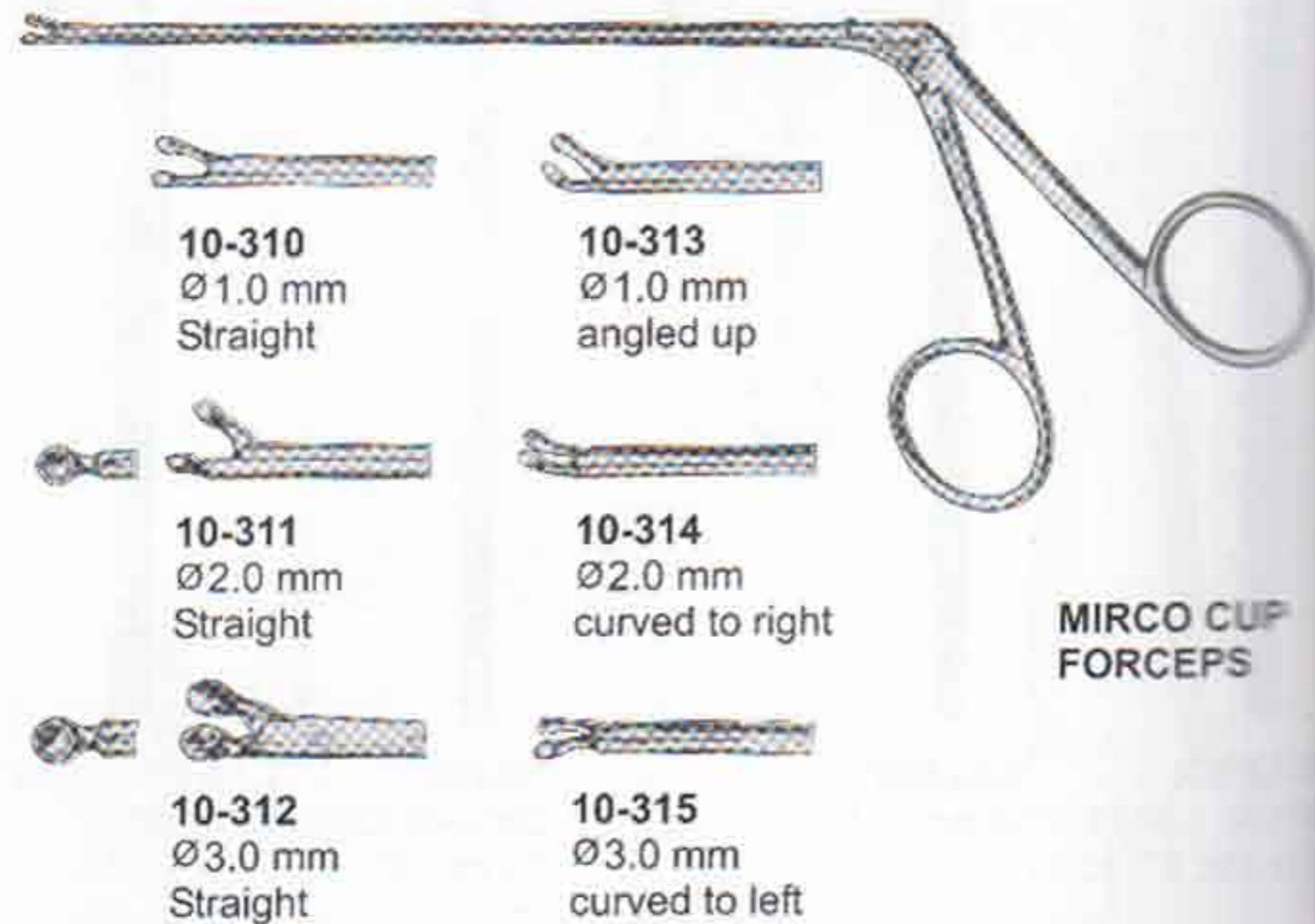
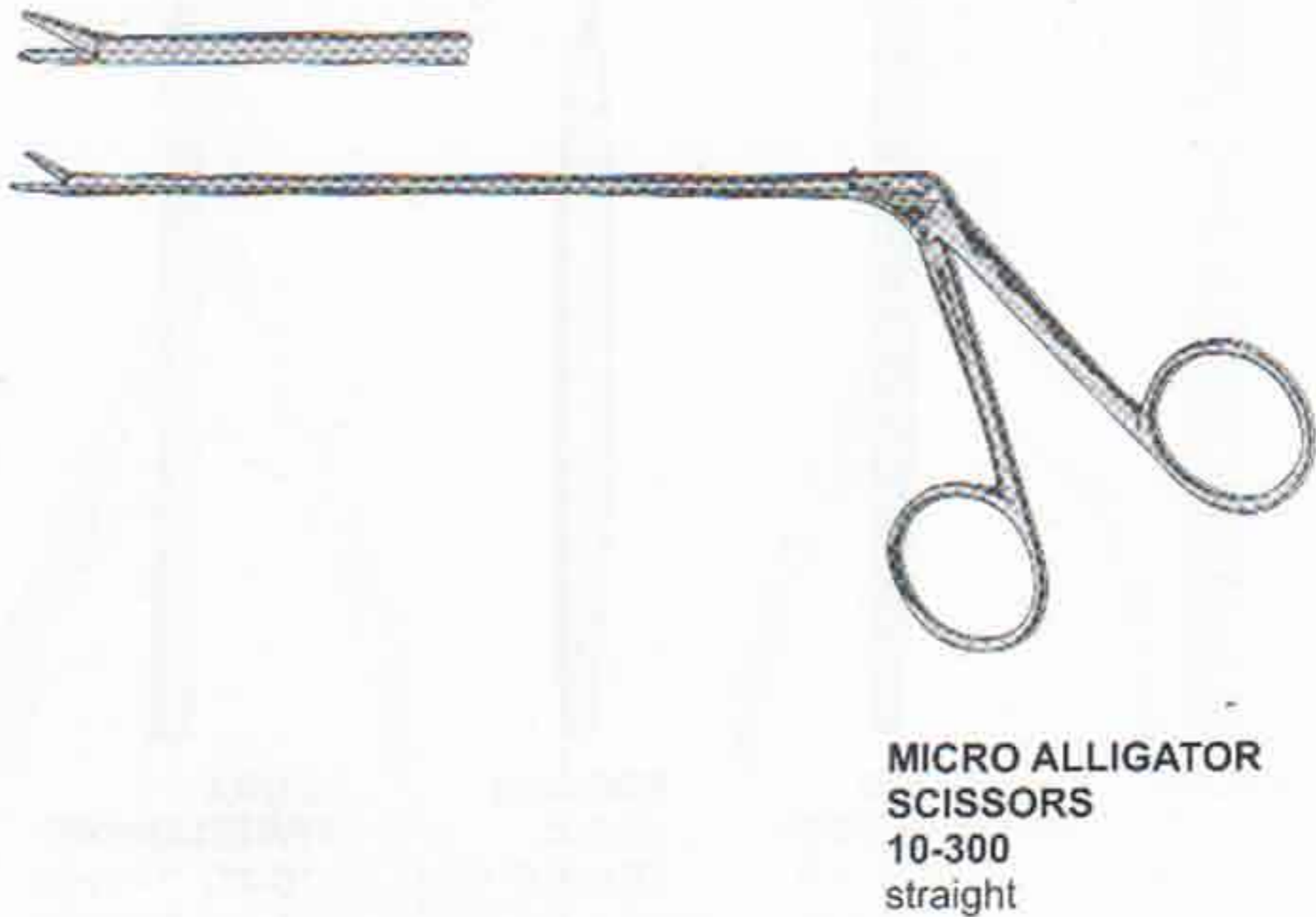
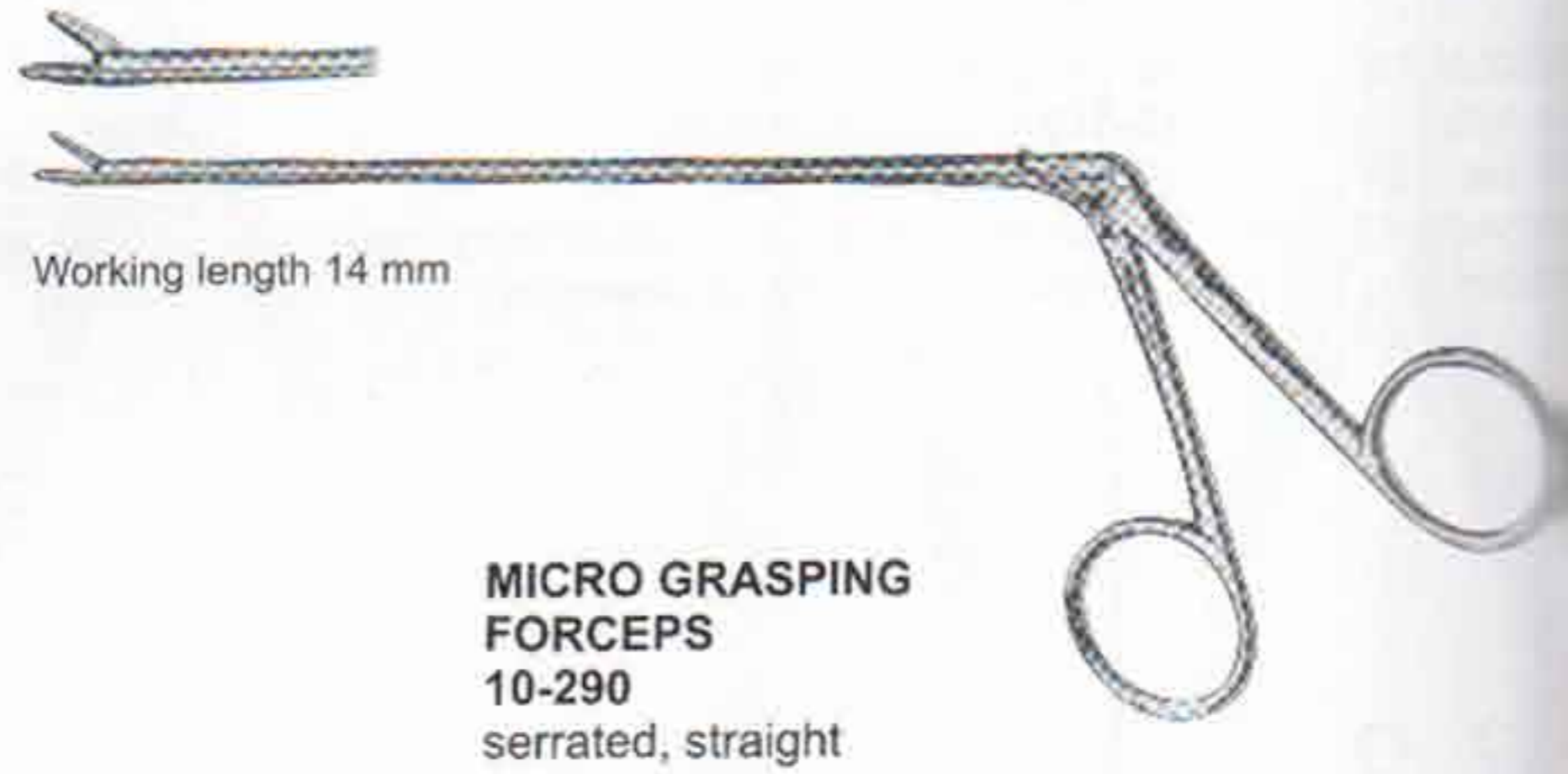
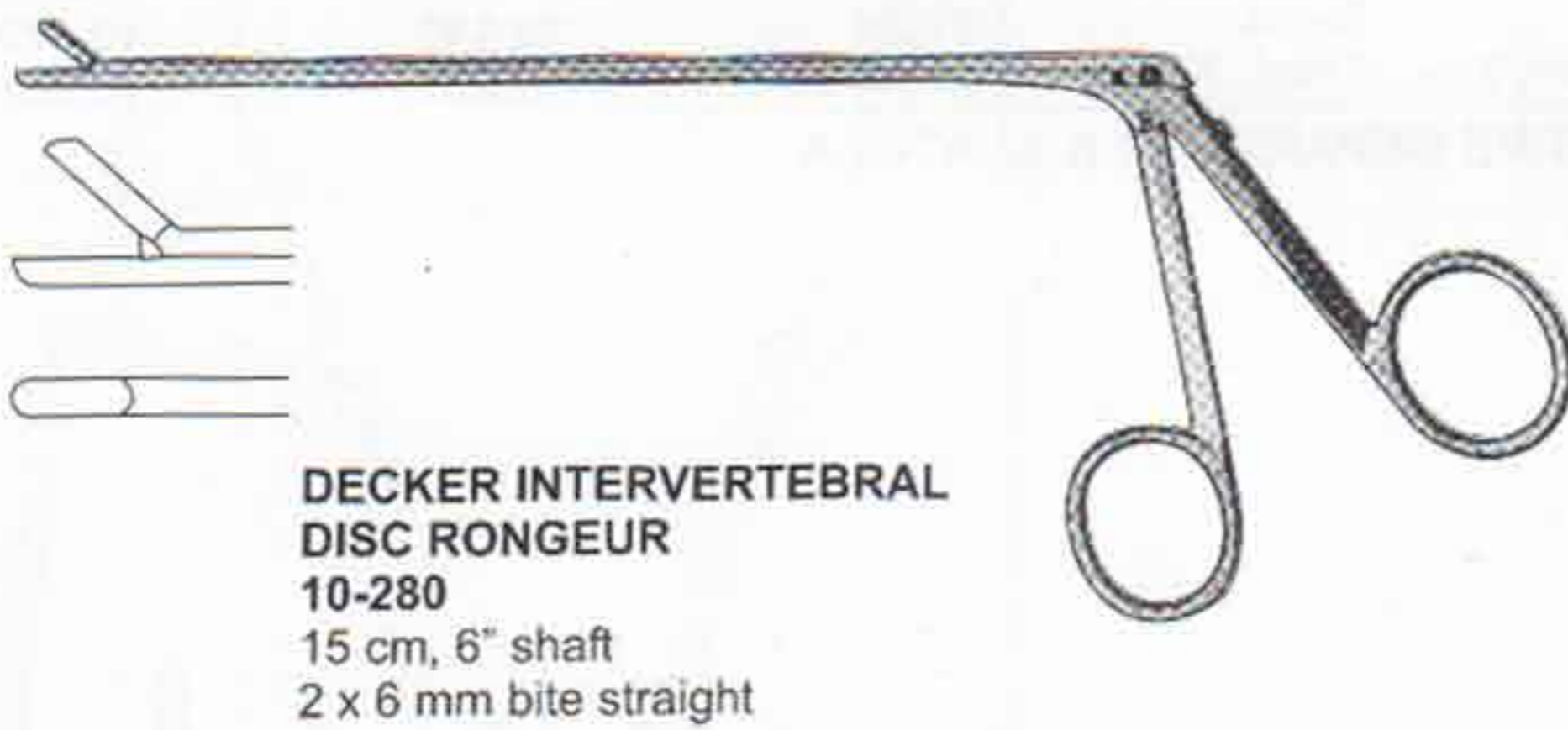
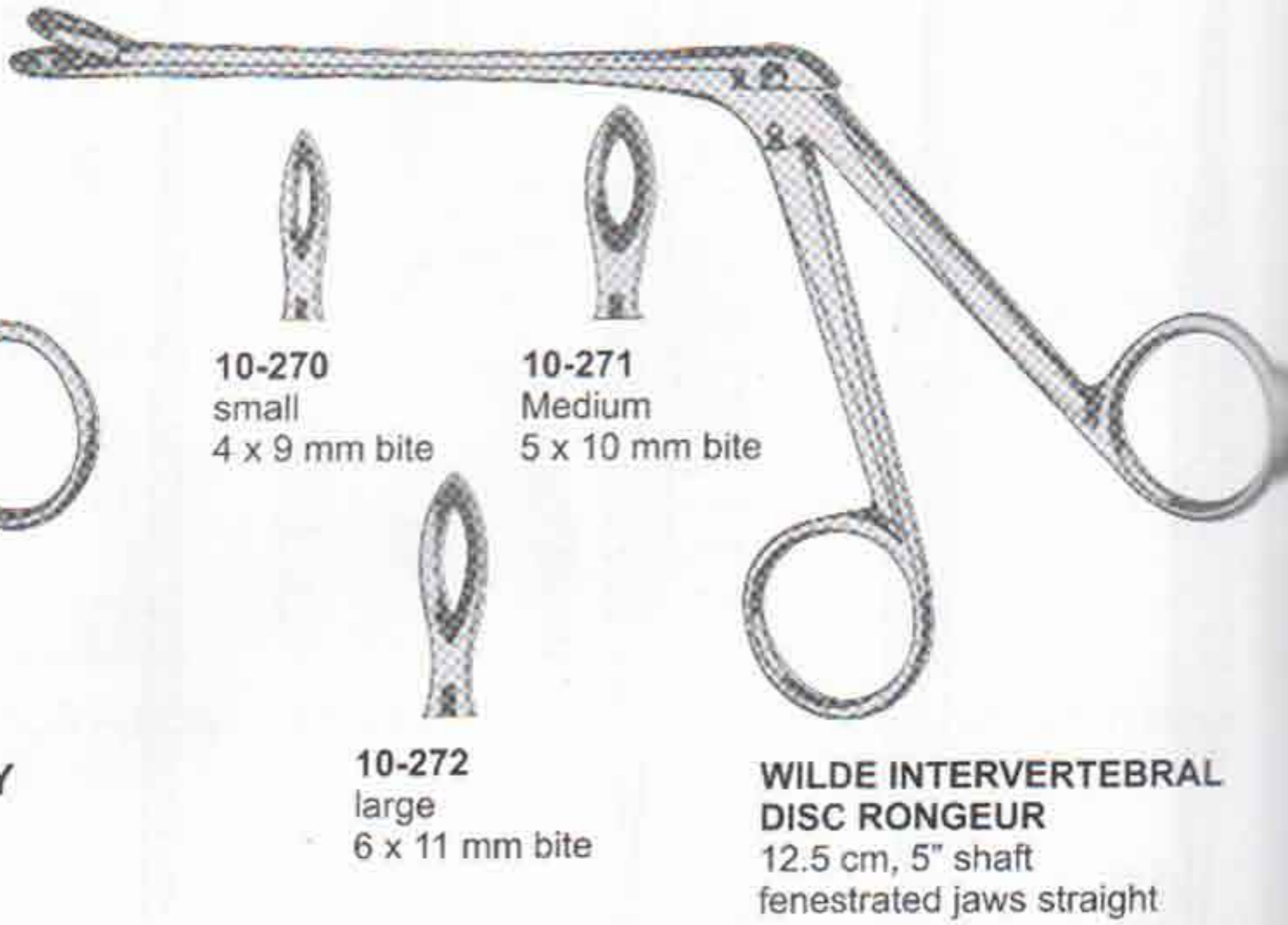
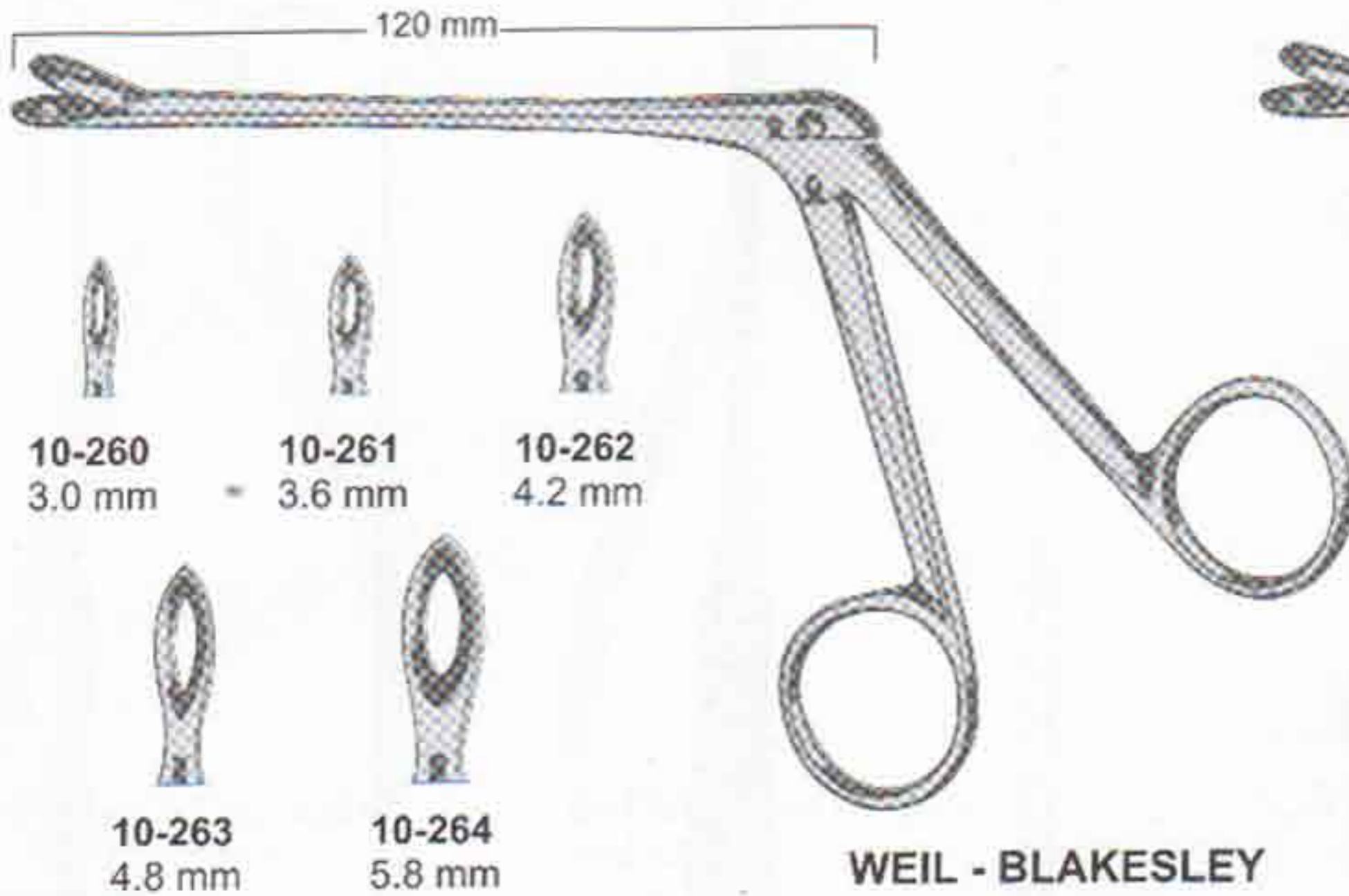



# LAMINECTOMY RONGEURS

Laminektomietangen  
Pinzas Para Laminectomia

Pinces Pour Laminectomie  
Pinze Per Laminectomia

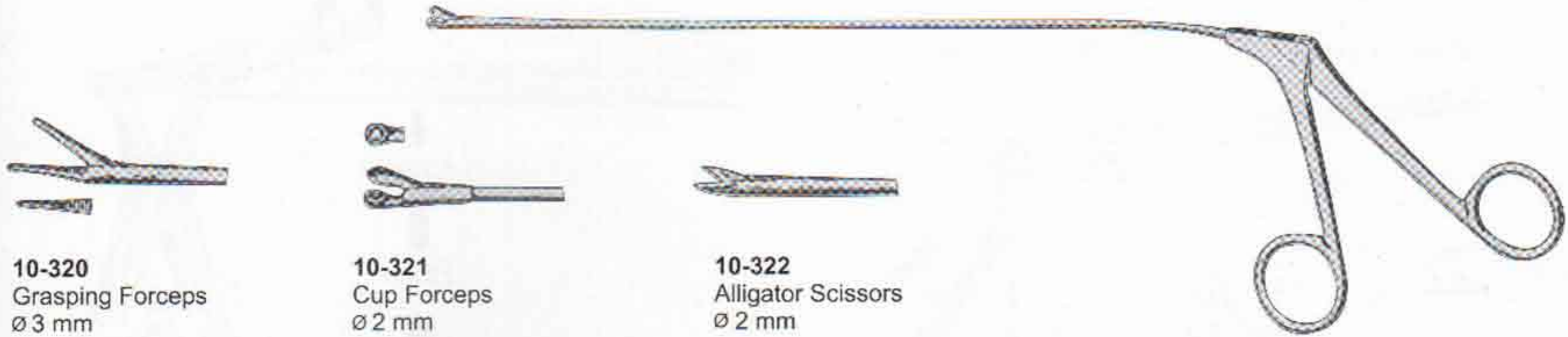

**10-320**  
Grasping Forceps  
Ø 3 mm

**10-321**  
Cup Forceps  
Ø 2 mm

**10-322**  
Alligator Scissors  
Ø 2 mm

**MICRO ALLIGATOR FORCEPS**  
with tubular shaft  
18 cm, 7"

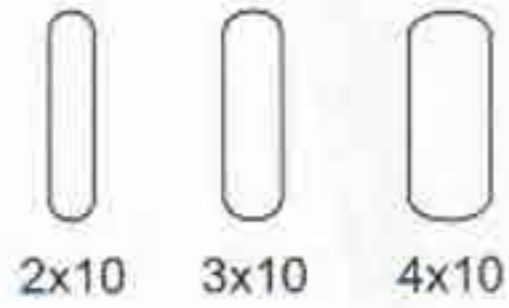

2x10 3x10 4x10



Straight Shaft	180 mm
Bite 2 x 10 mm	<b>10-330</b>
Bite 3 x 10 mm	<b>10-331</b>
Bite 4 x 10 mm	<b>10-332</b>

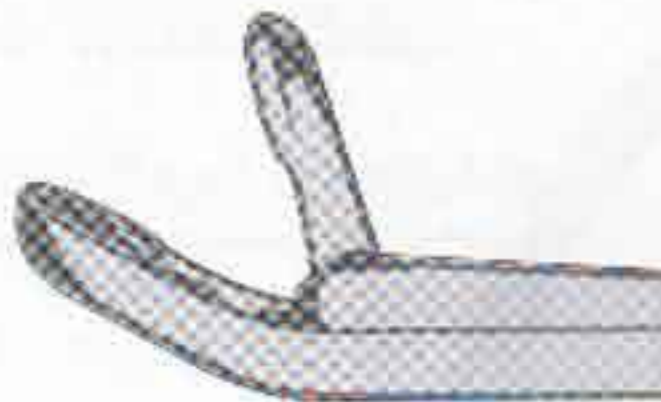

Angled - up Shaft	180 mm
Bite 2 x 10 mm	<b>10-333</b>
Bite 3 x 10 mm	<b>10-334</b>
Bite 4 x 10 mm	<b>10-335</b>



Angled - down Shaft	180 mm
Bite 2 x 10 mm	<b>10-336</b>
Bite 3 x 10 mm	<b>10-337</b>
Bite 4 x 10 mm	<b>10-338</b>

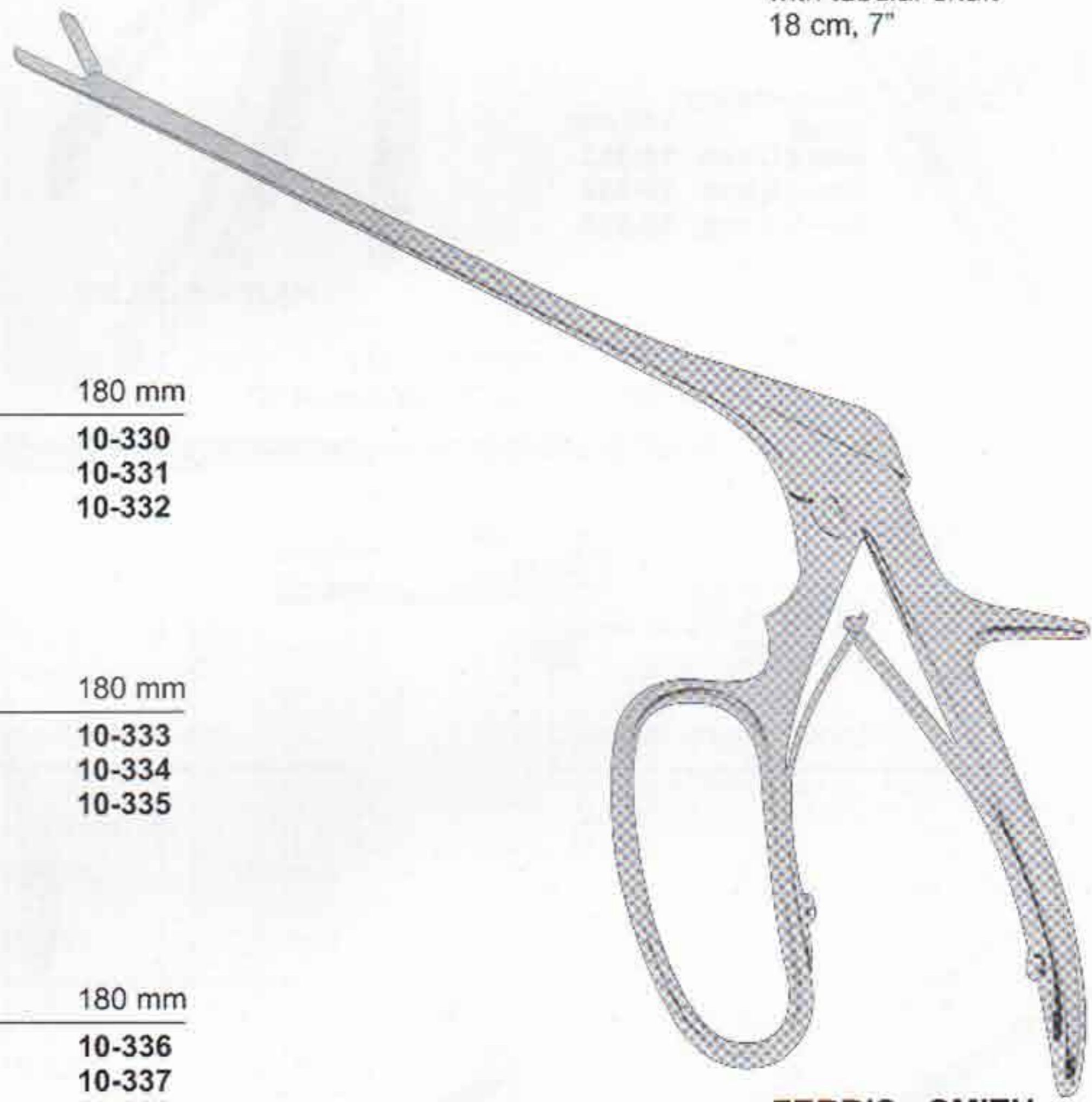

**FERRIS - SMITH**



4 mm 5 mm 6 mm

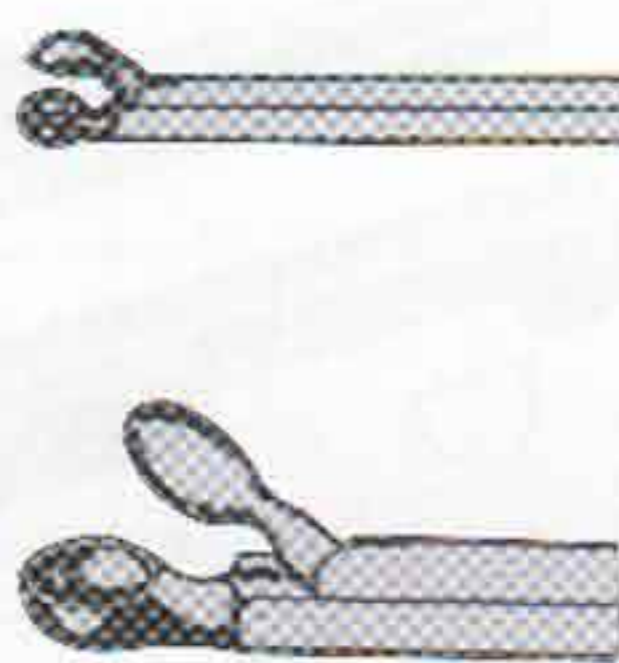

OldBerg Shaft	180 mm
Bite Ø 4 mm	<b>10-340</b>
Bite Ø 5 mm	<b>10-341</b>
Bite Ø 6 mm	<b>10-342</b>

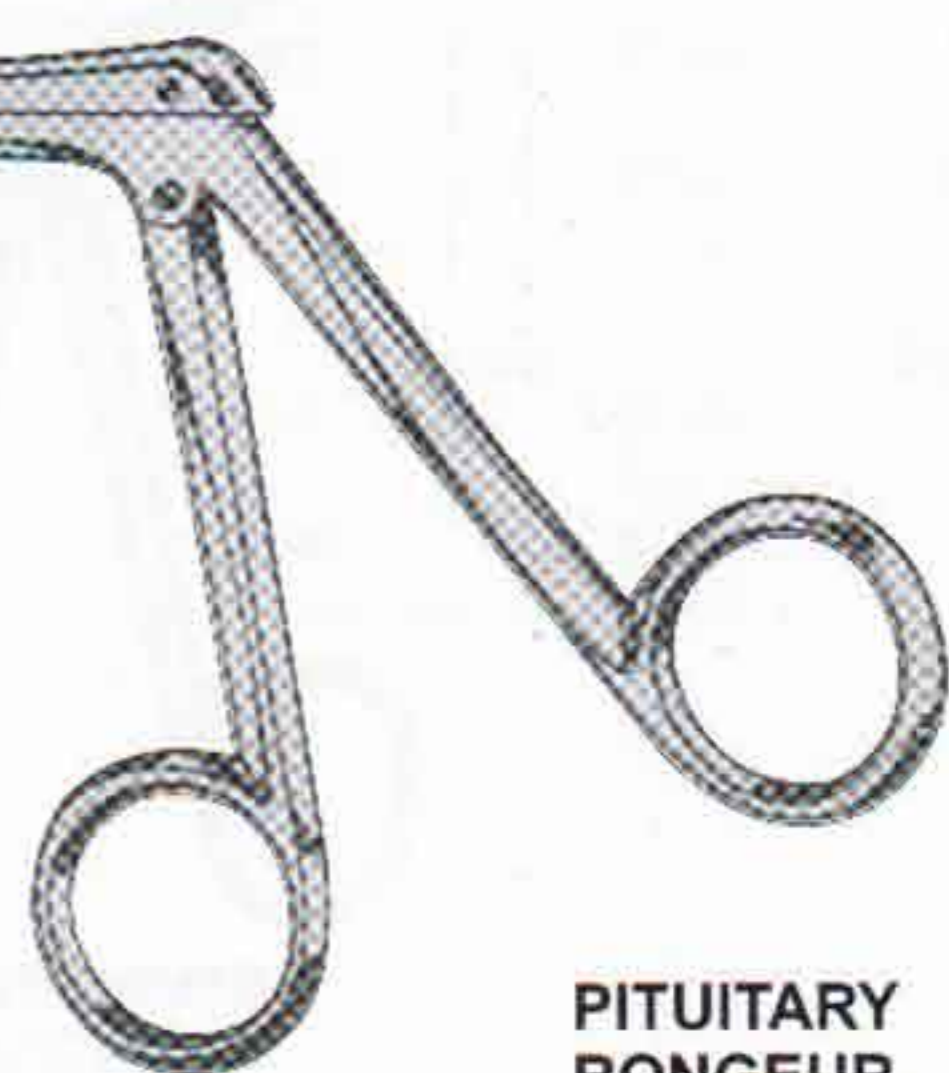

**PITUITARY RONGEUR**



2.0 mm 3.0 mm 3.5 mm



90°  
Up-cutting  
Shaft 140 mm  
Bite 2.0 mm **10-350**  
Bite 3.0 mm **10-351**  
Bite 3.5 mm **10-352**



90°  
Down-cutting  
Shaft 140 mm  
Bite 2.0 mm **10-353**  
Bite 3.0 mm **10-354**  
Bite 3.5 mm **10-355**

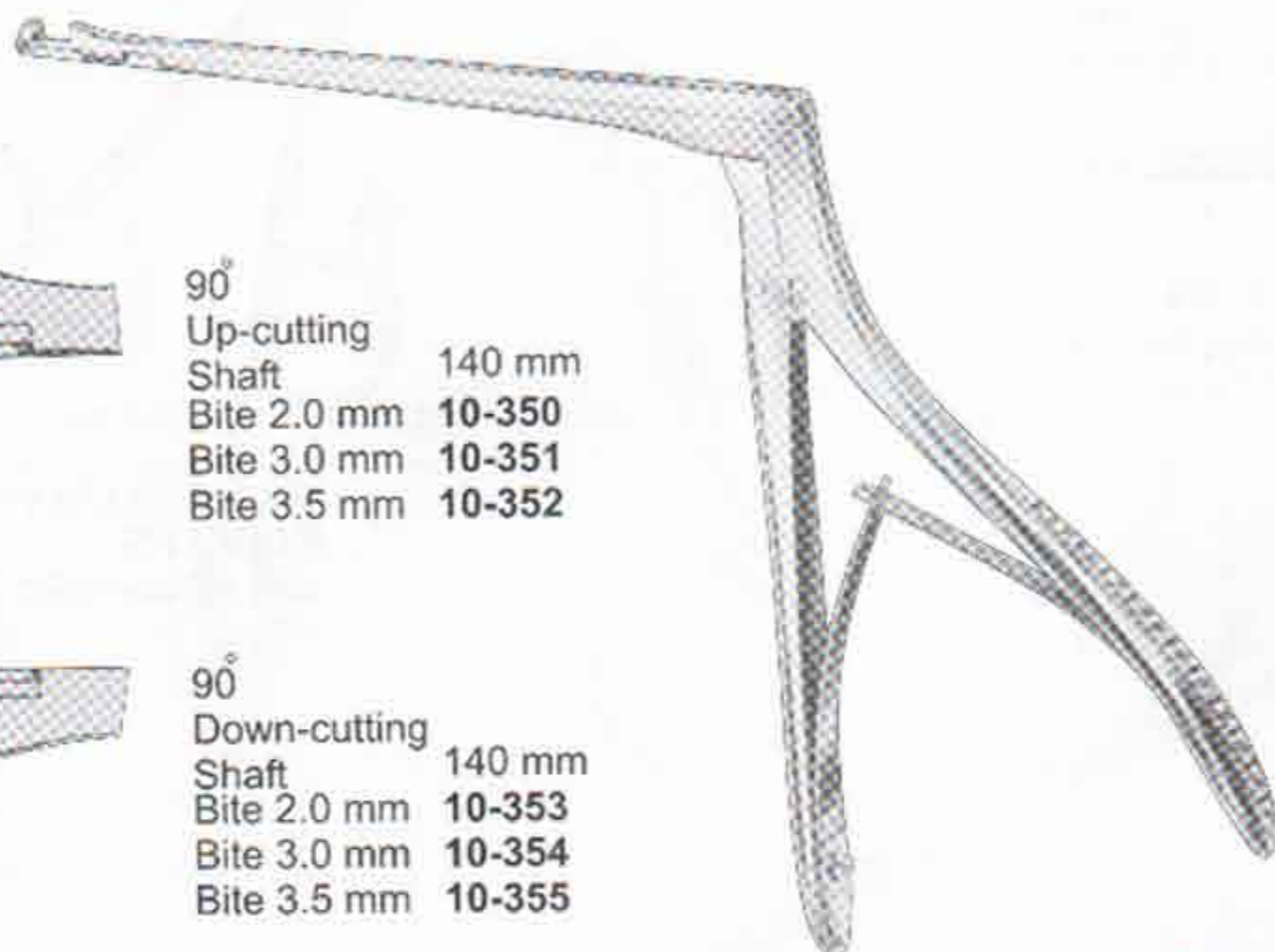

**HAJEK-KOFLER**

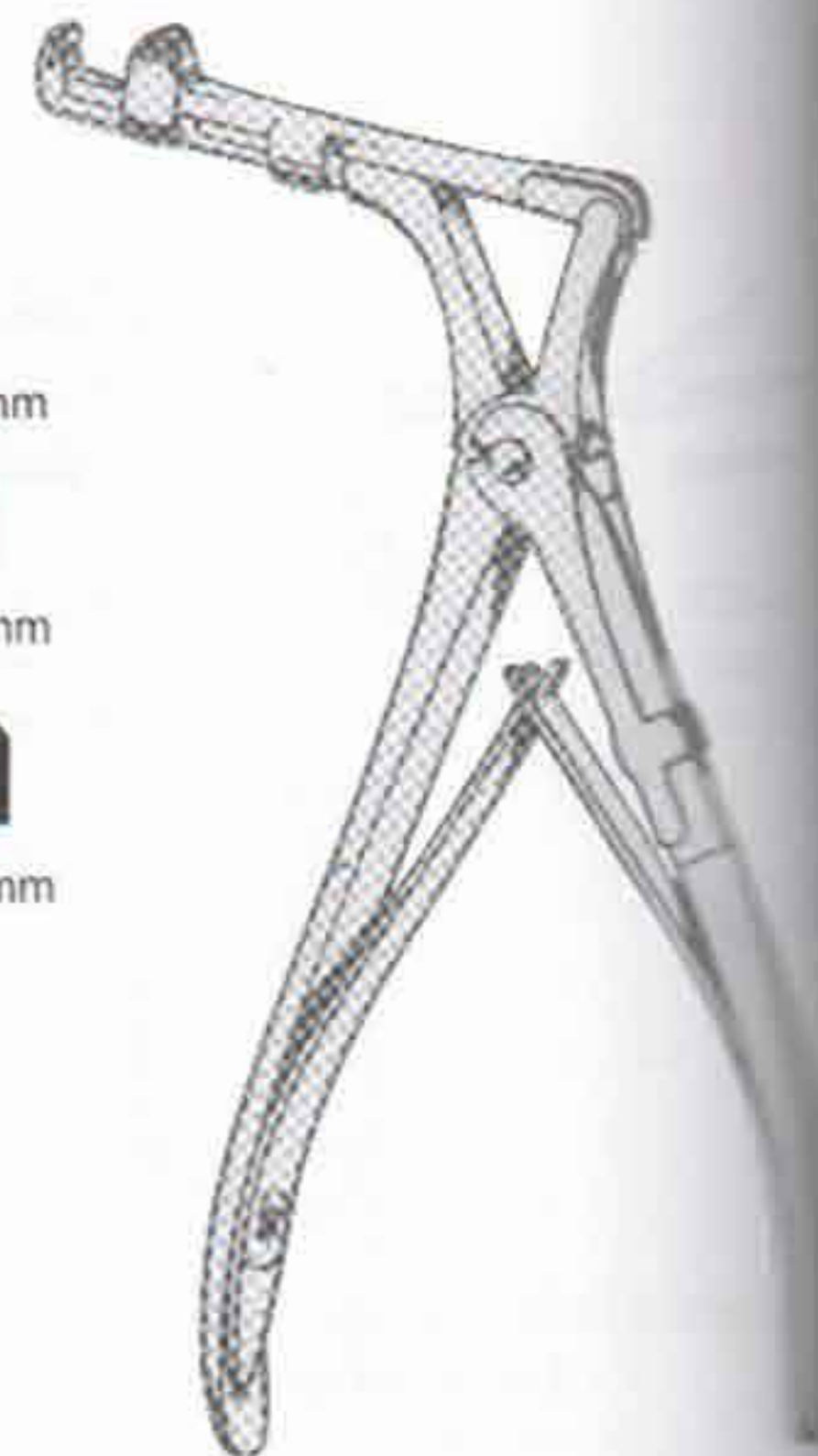

1.0 mm  
2.5 mm  
4.0 mm

**CITELLI**  
10-360 1.0 mm  
10-361 2.5 mm  
10-362 4.0 mm

160 mm, 6 1/4"

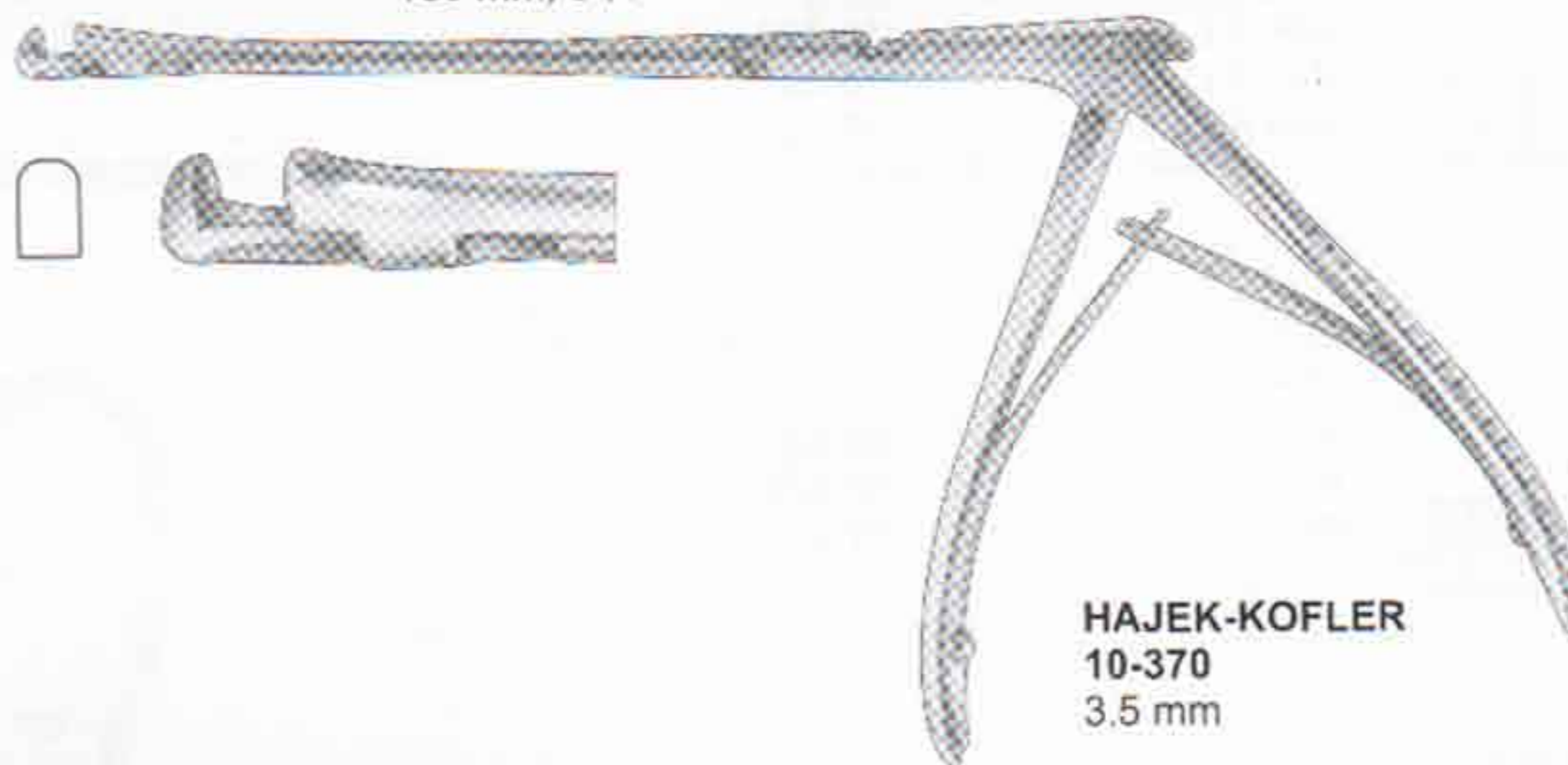

**HAJEK-KOFLER**  
10-370  
3.5 mm

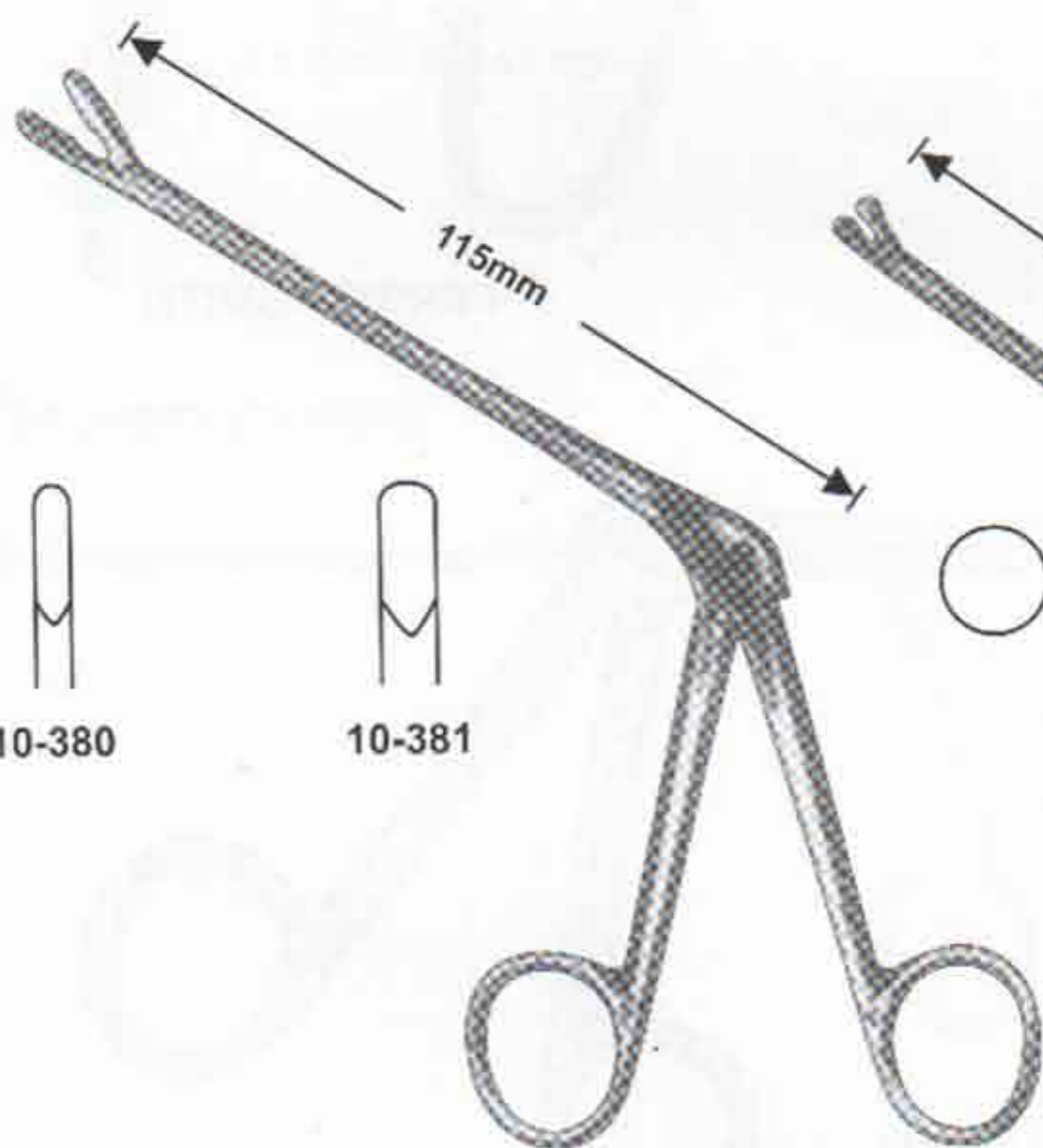

10-380

10-381

**SPURLING-LOVE**  
10-380 28cm  
10-381 28cm

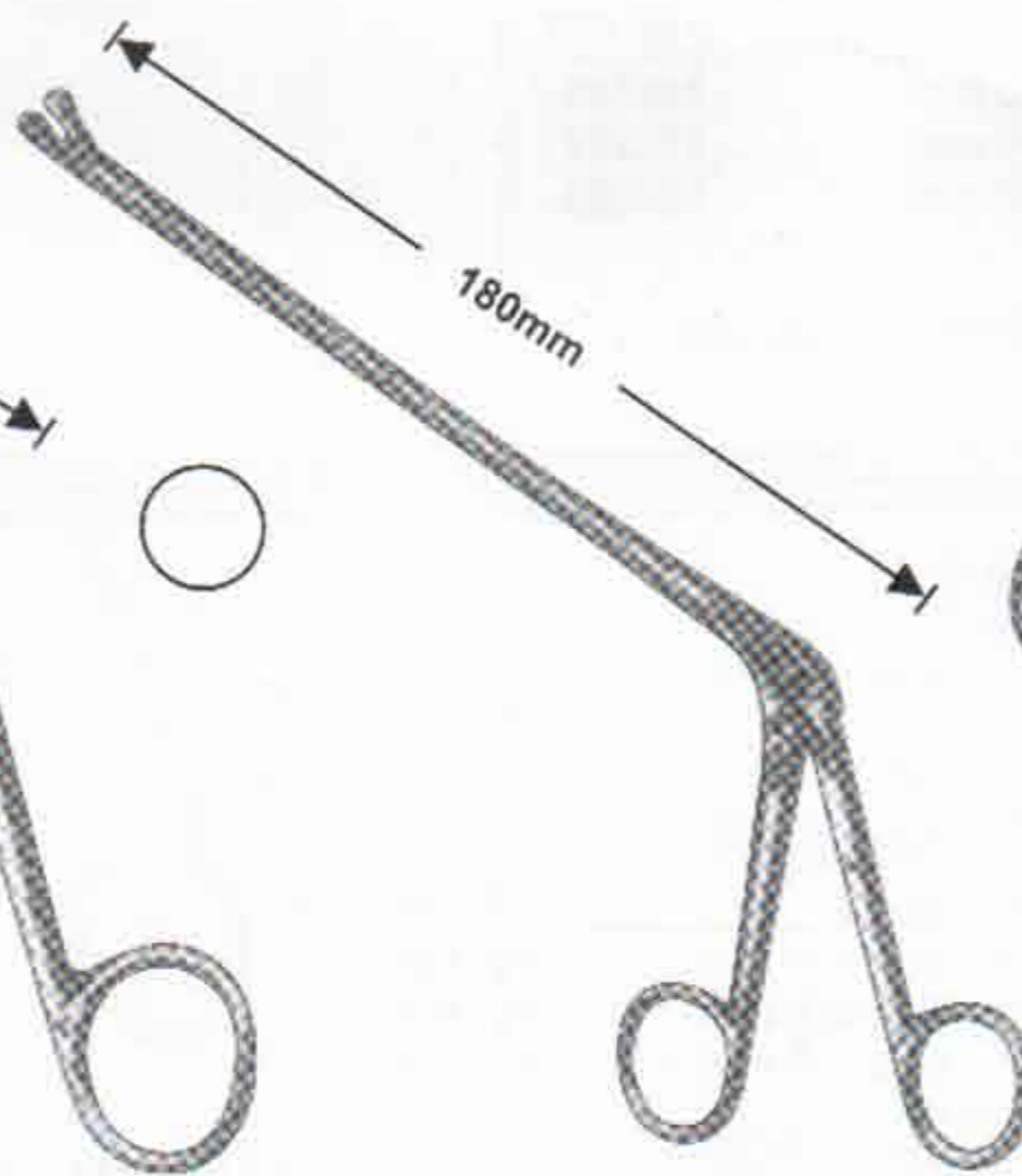

**OLDBERG**  
10-390 25cm



**COLCLOUGH**  
10-400 27cm UP CUT  
10-401 27cm DOWN CUT



# PUNCHES

Laminectomiestanzen  
Pinzas Cortantes Para Laminectomía

Pinces Emporte-pièces à Laminectomie  
Pinze Taglienti Per Laminectomia





LOVE-KERRISON  
LAMINECTOMY PUNCH





Forward 90° Regular Footplate

	2 mm bite forward	
	<b>10-410</b>	150 mm
	<b>10-411</b>	200 mm

	3 mm bite forward	
	<b>10-412</b>	150 mm
	<b>10-413</b>	200 mm

	4 mm bite forward	
	<b>10-414</b>	150 mm
	<b>10-415</b>	200 mm

	5 mm bite forward	
	<b>10-416</b>	150 mm
	<b>10-417</b>	200 mm

	6 mm bite forward	
	<b>10-418</b>	150 mm
	<b>10-419</b>	200 mm



Up 40° Regular footplate

	2 mm bite up	
	<b>10-420</b>	150 mm
	<b>10-421</b>	200 mm

	3 mm bite up	
	<b>10-422</b>	150 mm
	<b>10-423</b>	200 mm

	4 mm bite up	
	<b>10-424</b>	150 mm
	<b>10-425</b>	200 mm

	5 mm bite up	
	<b>10-426</b>	150 mm
	<b>10-427</b>	200 mm

	6 mm bite up	
	<b>10-428</b>	200 mm



Down 90° Regular footplate

	2 mm bite down	
	<b>10-429</b>	150 mm
	<b>10-430</b>	200 mm

	3 mm bite down	
	<b>10-429</b>	150 mm
	<b>10-430</b>	200 mm

	4 mm bite down	
	<b>10-431</b>	150 mm
	<b>10-432</b>	200 mm

	5 mm bite down	
	<b>10-433</b>	150 mm
	<b>10-434</b>	200 mm



# LAMINA SPREADERS FORCEPS

Wirbelkörperspreizer  
Separadores Para Cuerpos Vertebrales

Ecarteurs Pour Corps Vertébraux  
Separatori Per Vertebre

## BRAIN CLAMPS

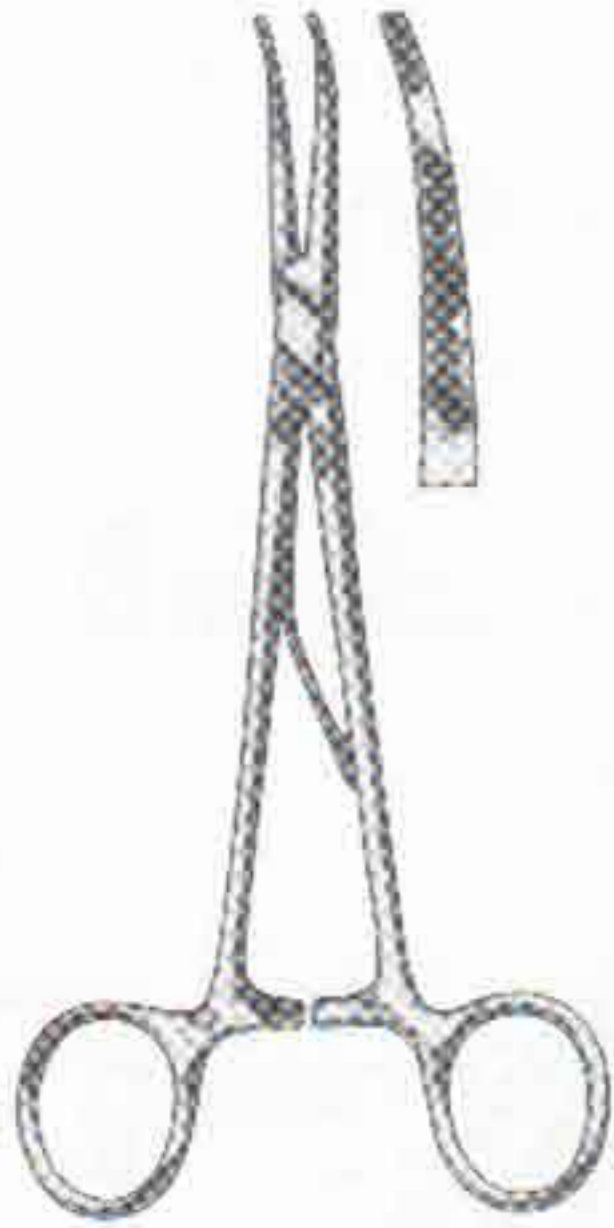

**MCKENZIE**  
10-440 15cm  
10-441 19cm

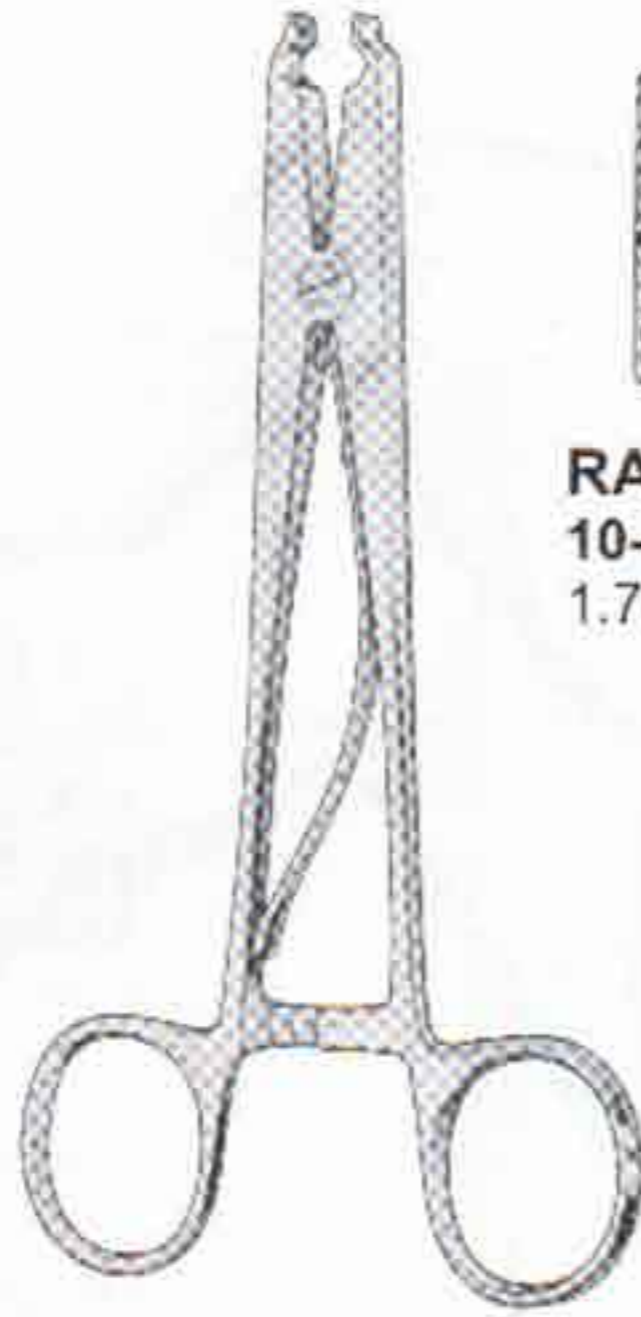

**RANEY**  
10-450  
16 cm, 6 1/2"



**RANEY**  
10-460  
1.7cm, 3/4"

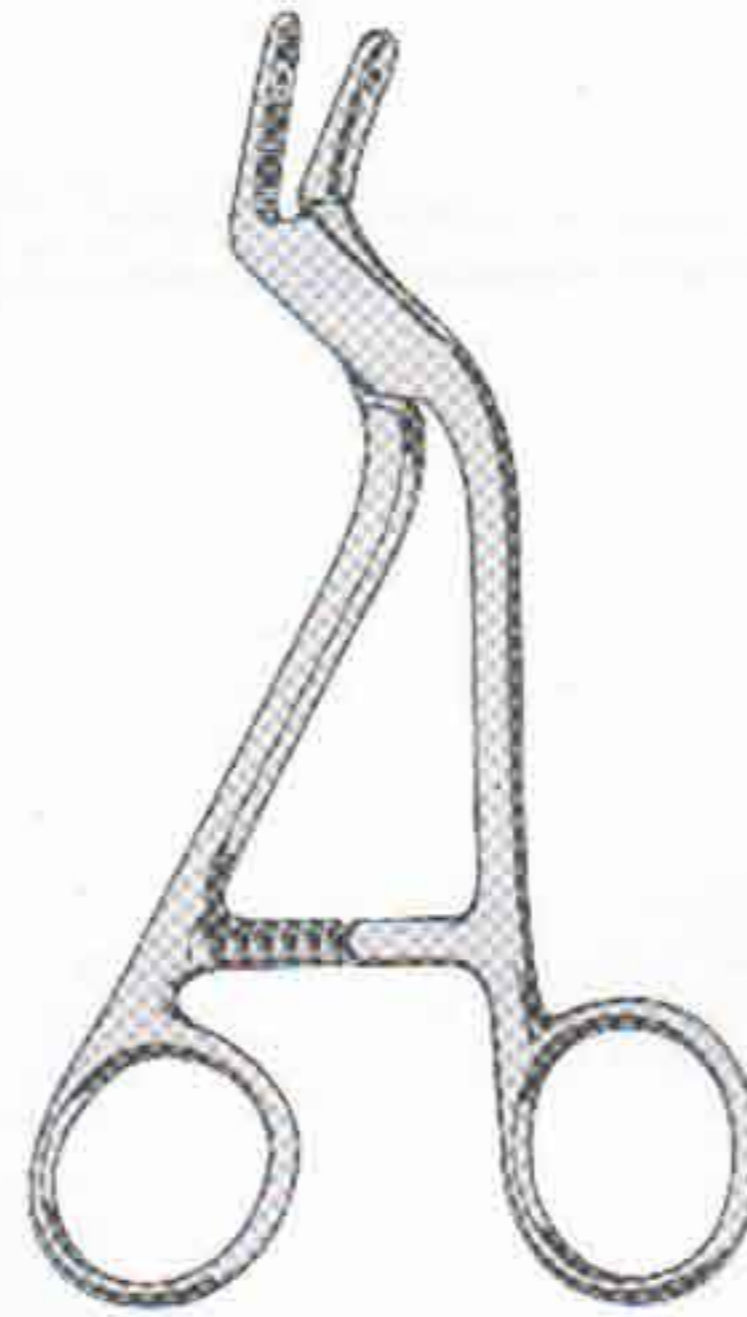

**ADSON**  
10-470 15 cm, 6"  
Drill Guide and  
Dura Protector

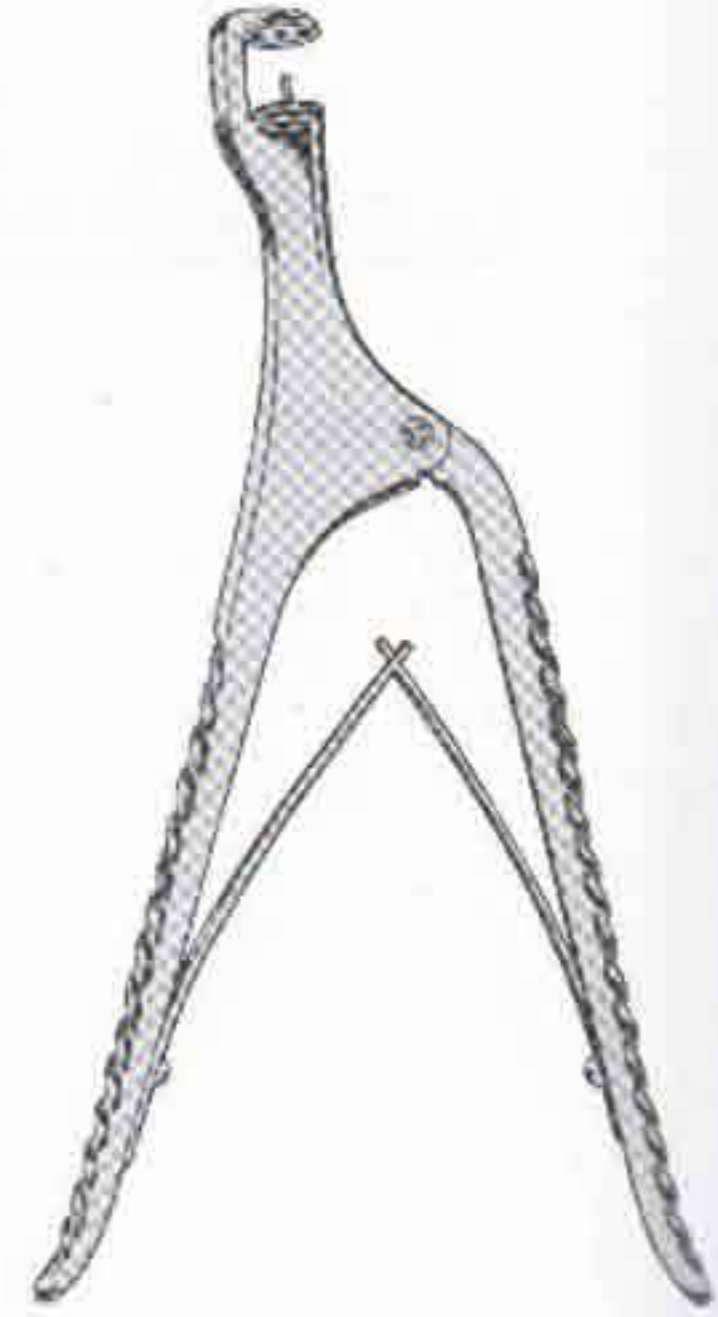

**CONE**  
10-480 20 cm 8"  
10-481 23 cm 9"  
Skull Punch



**DAHLGREN**  
10-490 20 cm, 8"  
Complete with 2 Blades

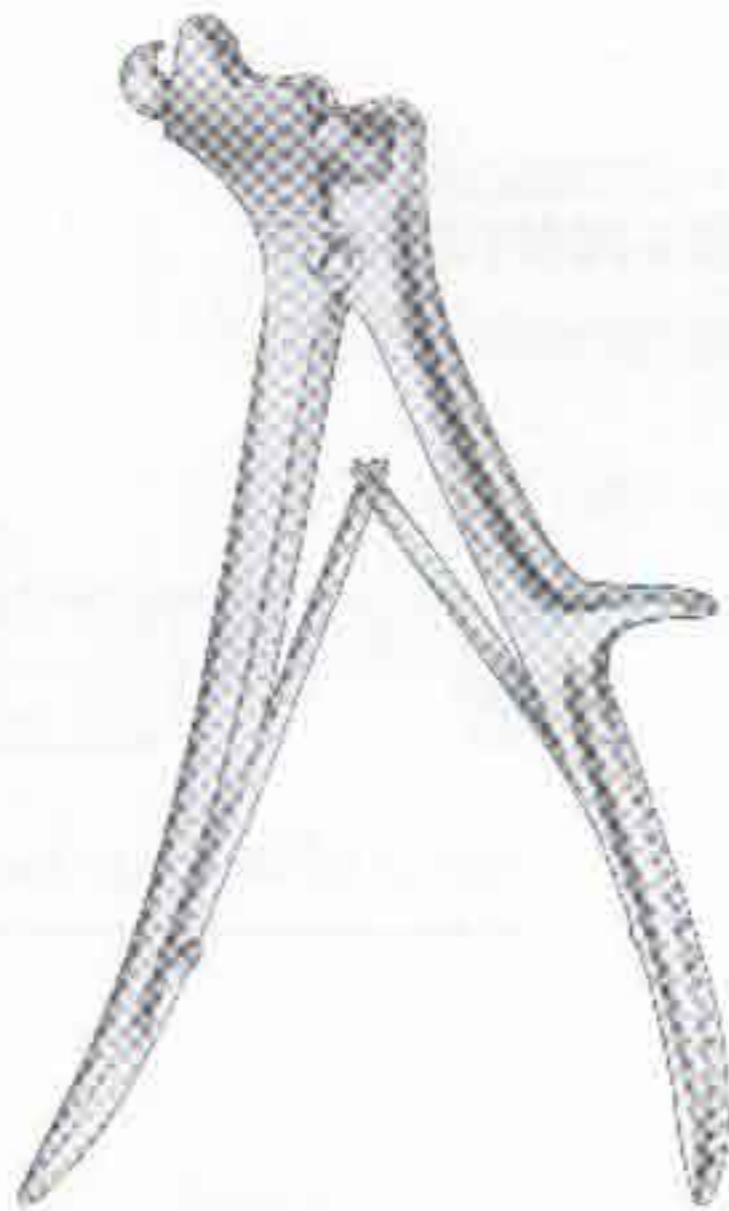

**DE VILBISS**  
10-500  
Skull cutting forceps  
21cm, 8 1/4"

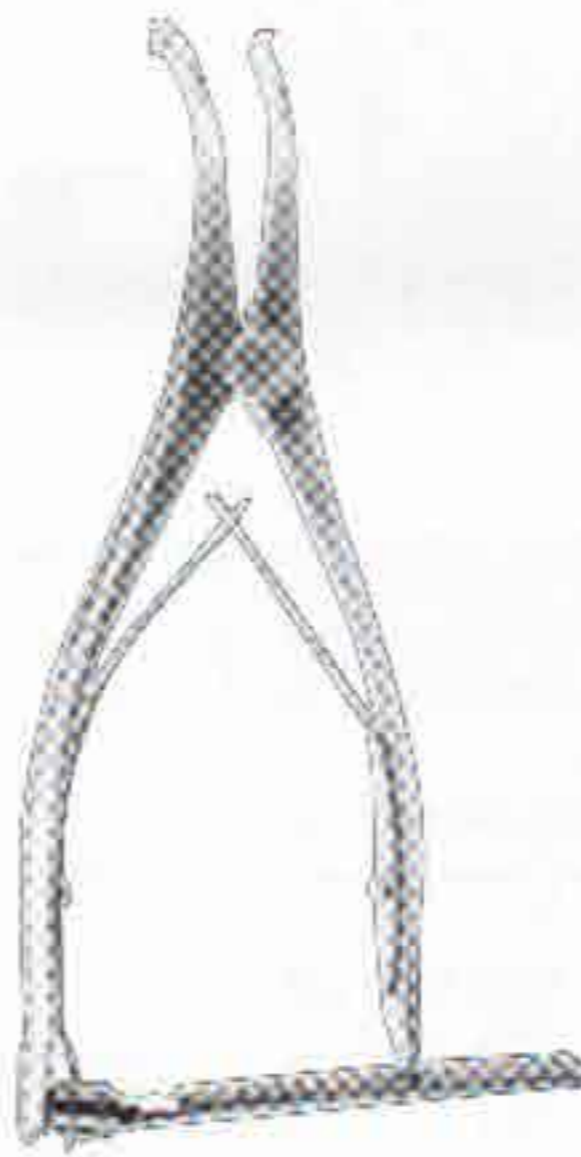

**INGE**  
10-510  
16 cm, 6 1/2"  
Small pattern

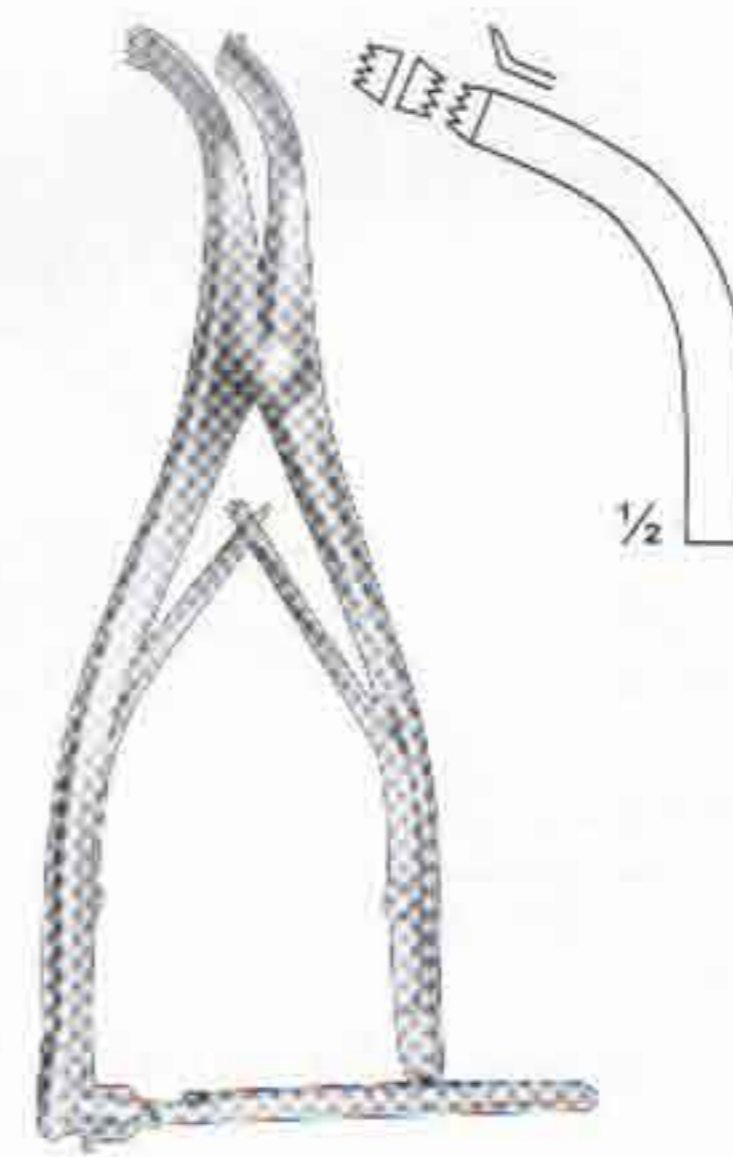

**INGE**  
10-520  
17 cm, 6 3/4"



**INGE** 26 cm, 10 1/4"  
10-530 Jaw width 5 cm  
10-531 Jaw width 10 cm  
large pattern

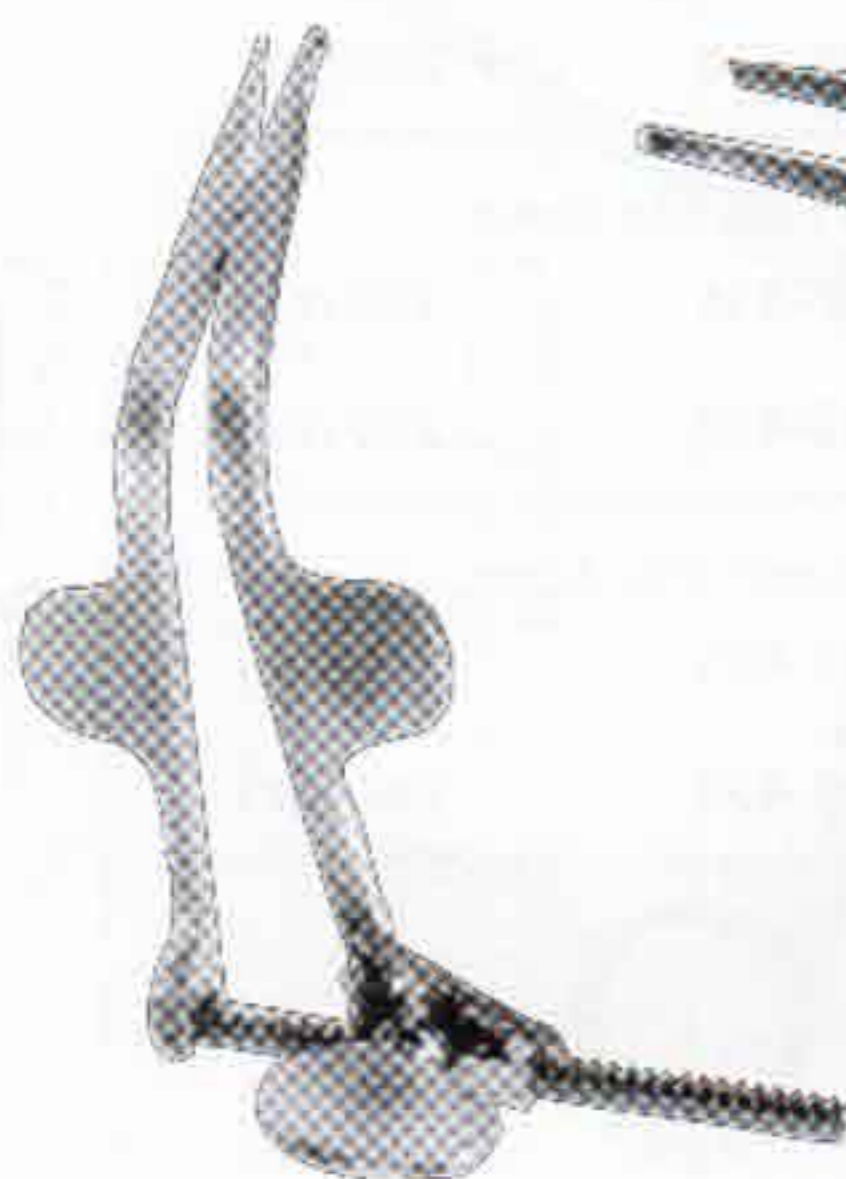

**CLOWARD**  
10-540  
13 cm, 5"

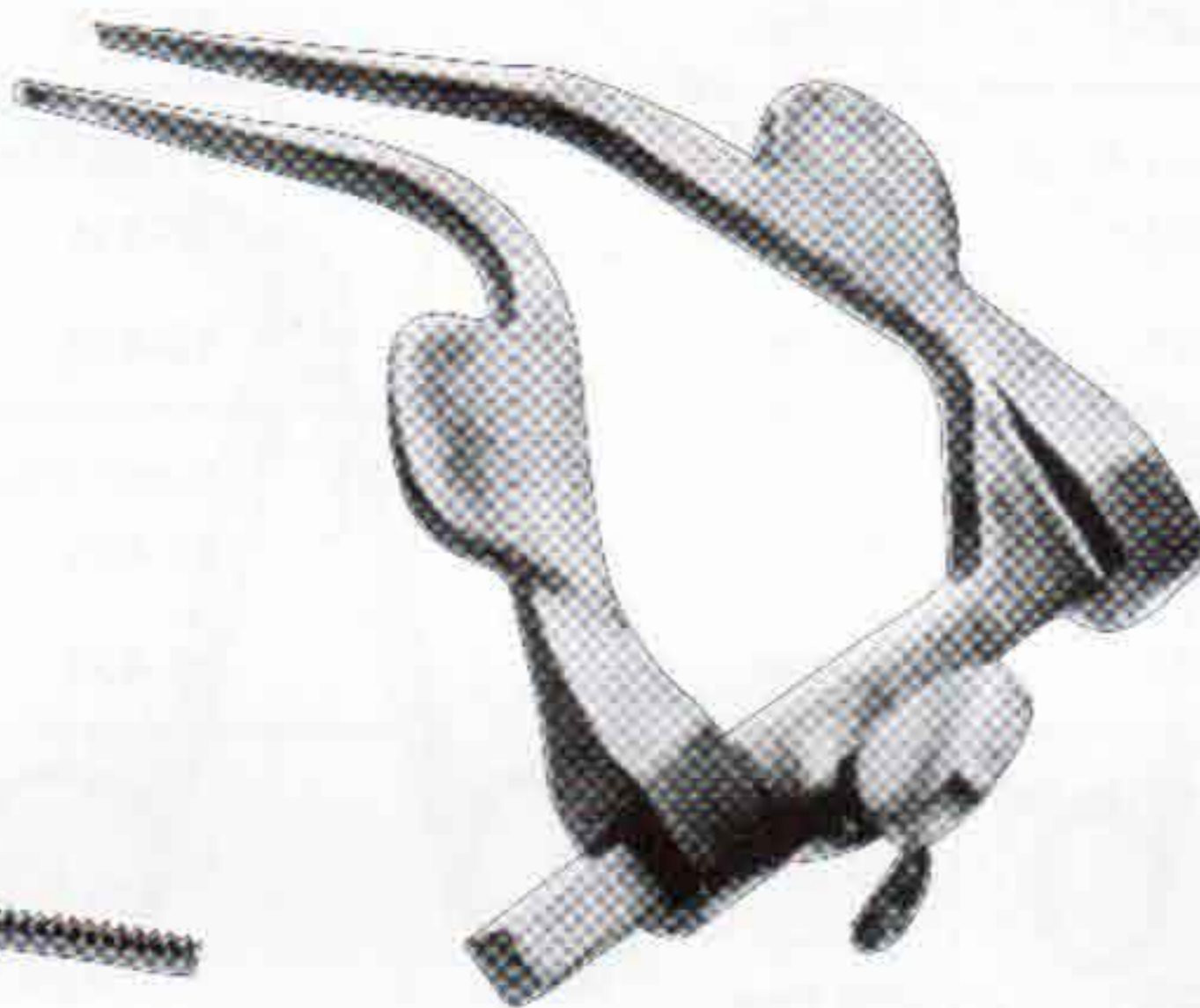

**LUMBAR LAMINA SPREADER**  
10-550  
arm length: 87.5 mm  
spread: 37.5 mm

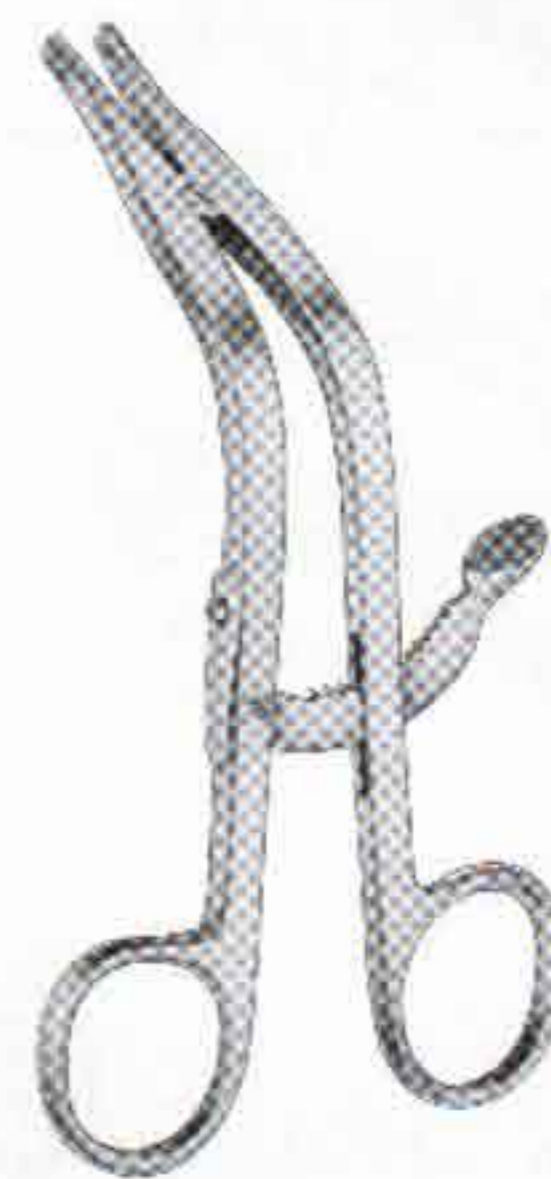

**CLOWARD**  
10-560  
16 cm, 6 1/2"



**10-570**  
14 cm, 5 1/2"



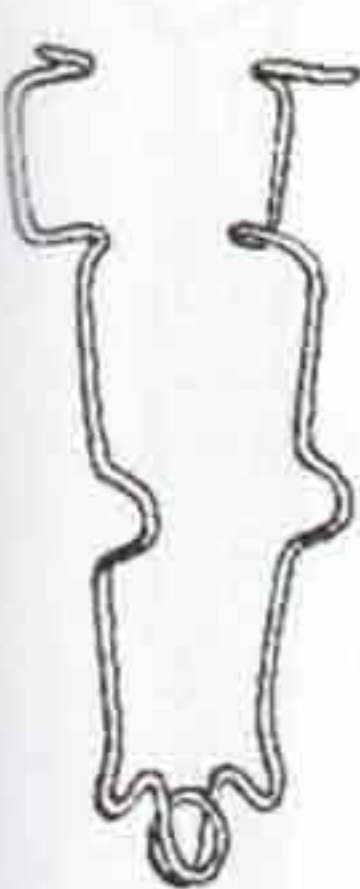

**BOWMAN**  
11-100 7 cm

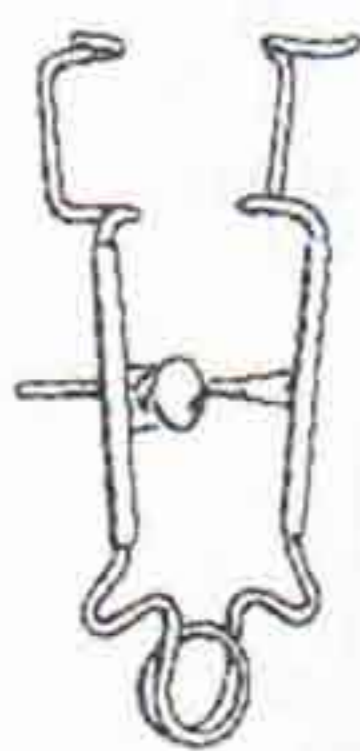

**CRITCHETT**  
11-110 6 cm



**SMITH**  
11-120 5 cm

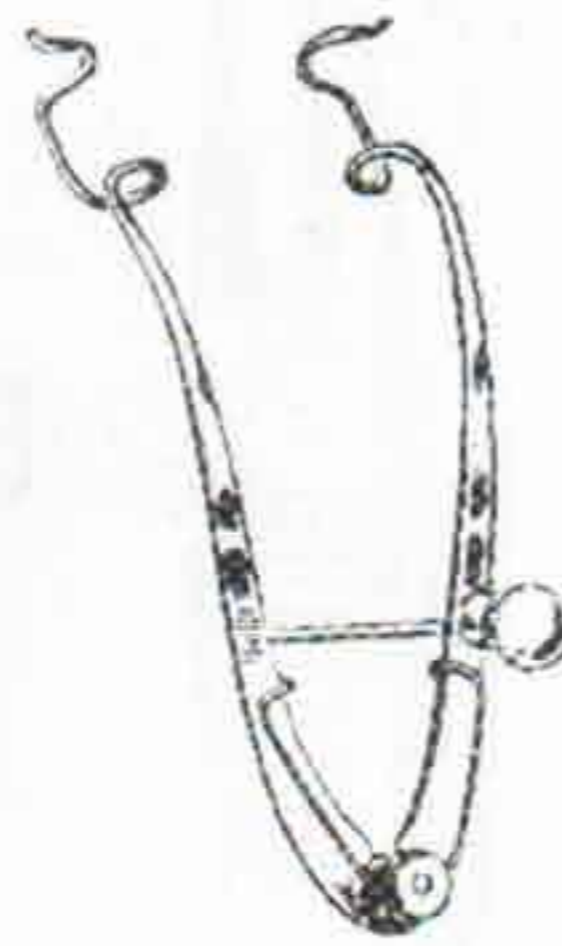

**CLARKE**  
11-130 8 cm



**GRAEFE**  
11-140 6 cm  
11-141 9 cm

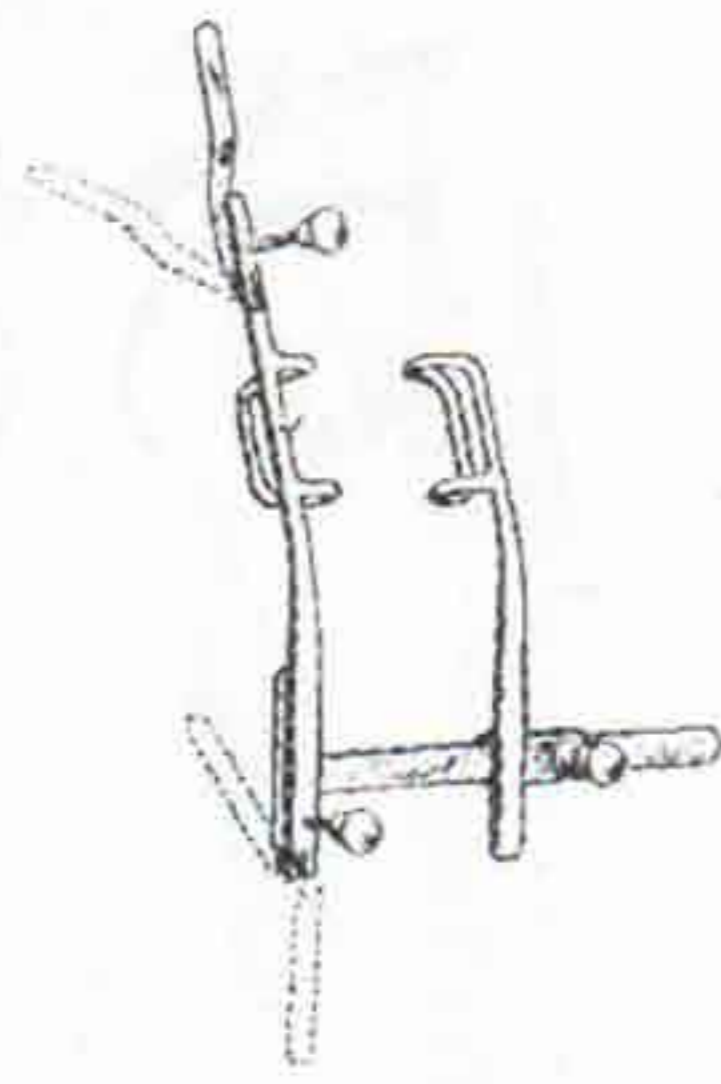

**ARRUGA**  
11-150 7 cm L  
11-151 9 cm R

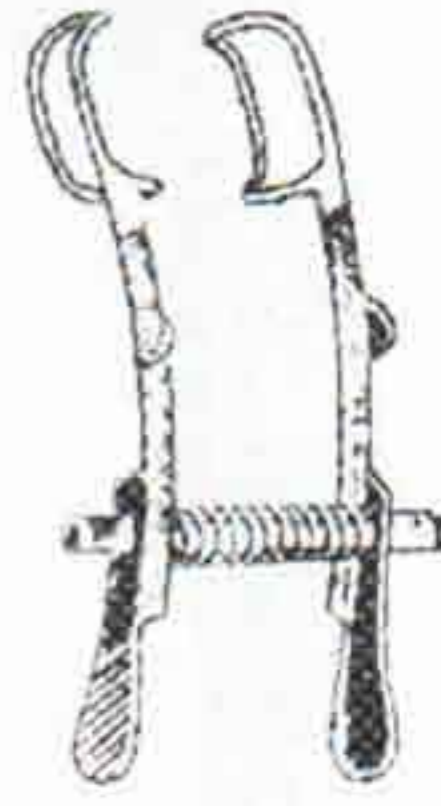

**MELLINGER**  
11-160 7 cm



**MUELLER**  
11-170 7 cm

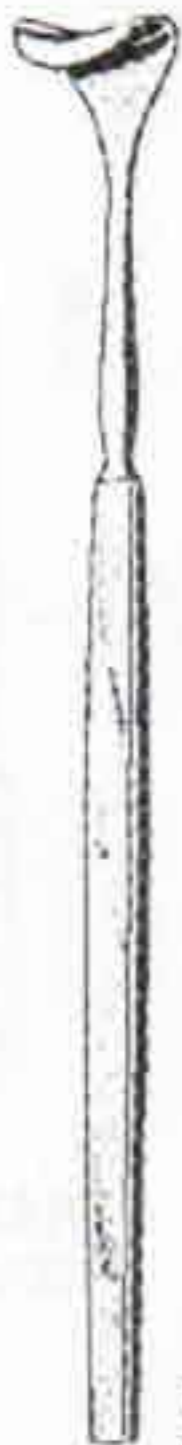

**DESMARRES**  
11-180 12 cm  
11-181 14 cm  
11-182 16 cm  
11-183 18 cm



**CATARACT**  
11-190 Fig 1  
11-191 Fig 2  
11-192 Fig 3  
11-193 Fig 4  
11-194 Fig 5  
11-195 Fig 6

**KNIVES**

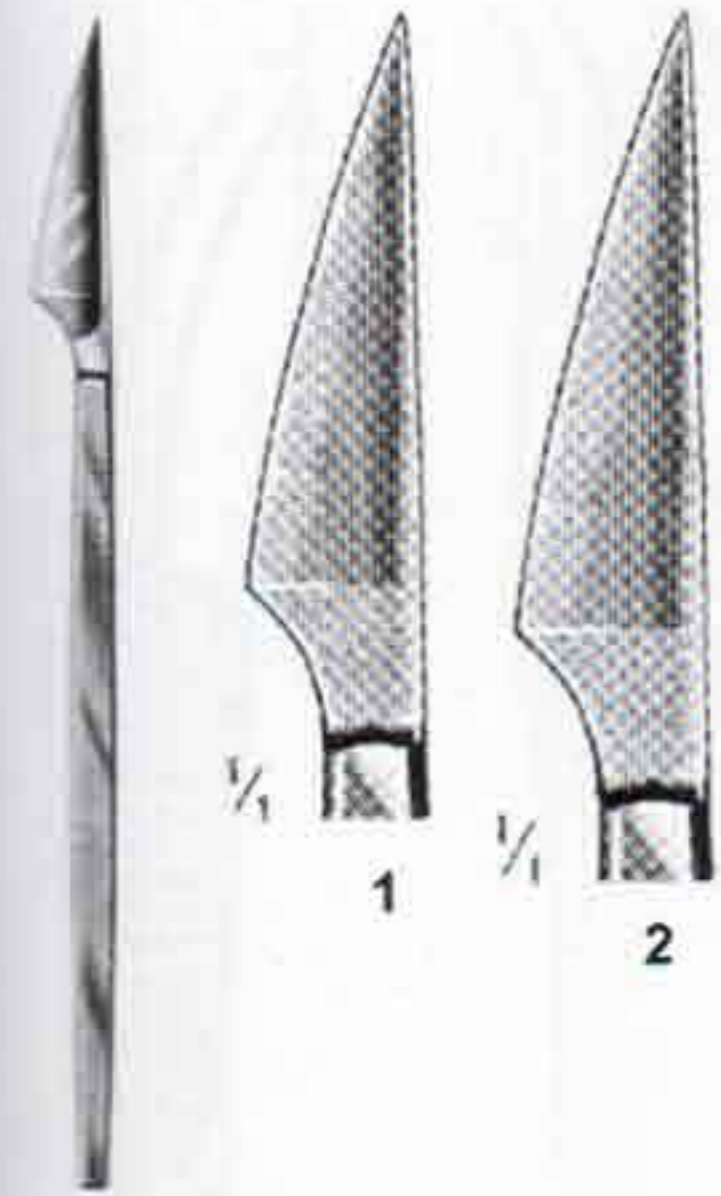
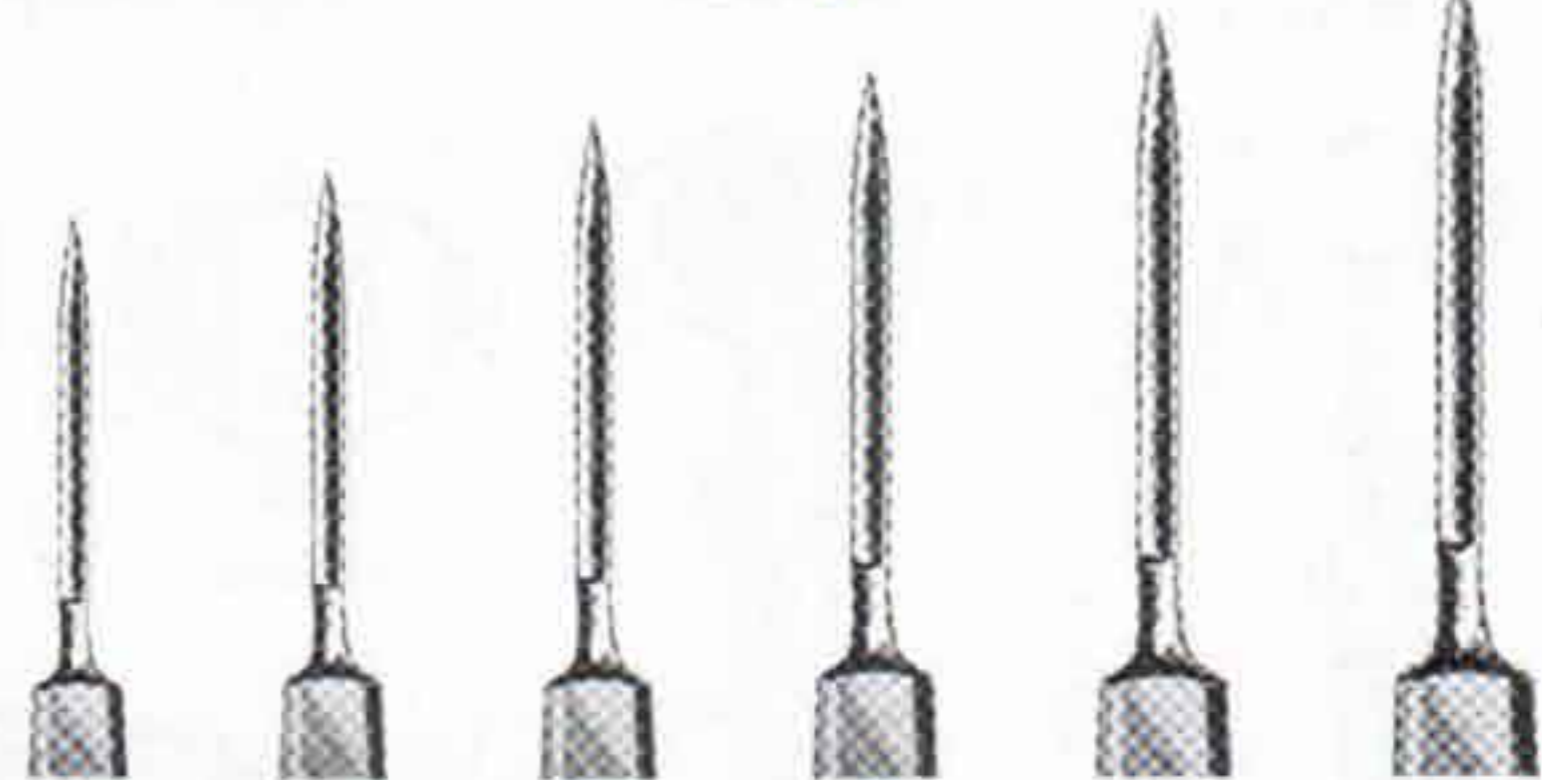

**BEER**  
11-200 Fig 1  
11-201 Fig 2



11-210 11-211 11-212 11-213 11-214 11-215 11-216 11-217  
**JAEGER** **JAEGER**





**SNELLEN**  
11-220 R  
11-221 L

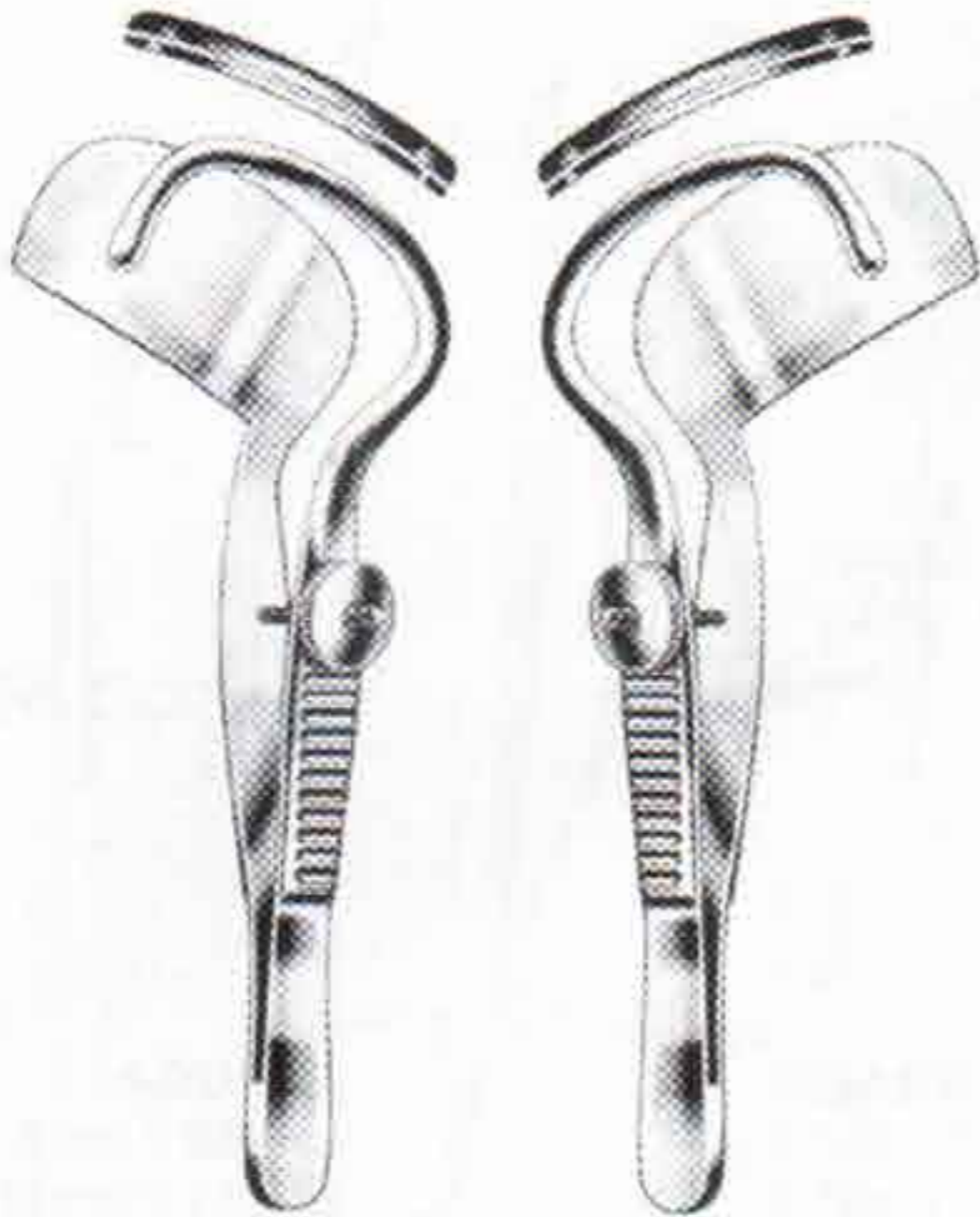

**DESMARRES**  
11-230 10cm 11-231



**KNAPP**  
11-240 11cm



**WECKER**  
11-250 11cm  
11-251 11cm  
11-252 11cm

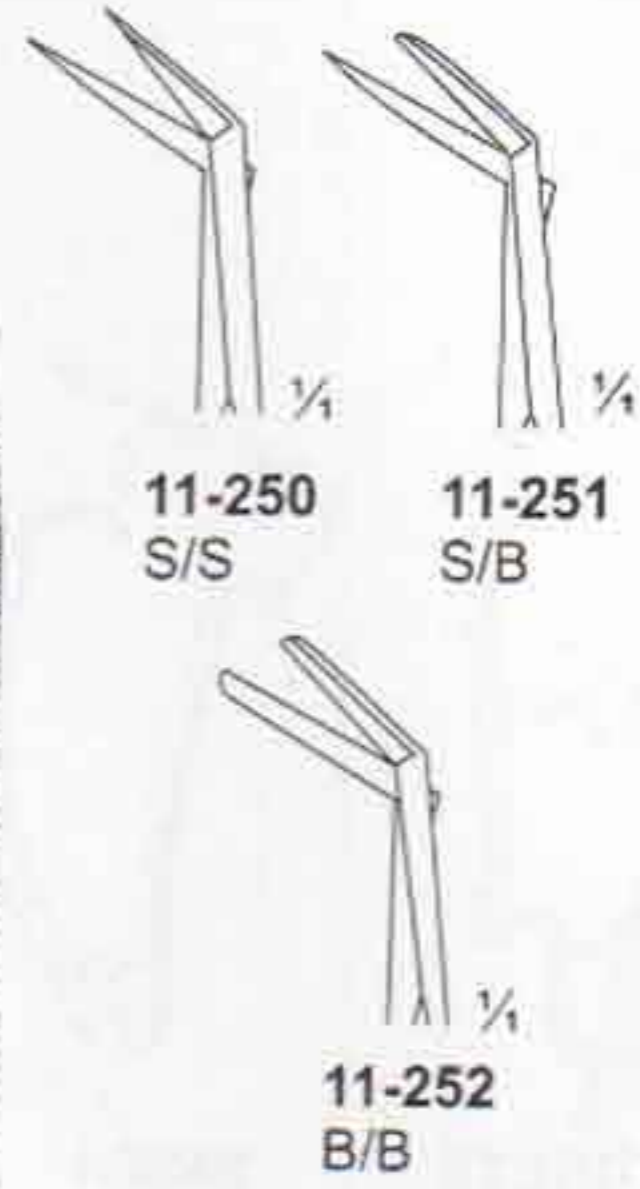

**AYER**  
11-260 9cm



**LAMBERT**  
11-270 9cm



**DESMARRES**  
11-280 9cm  
11-281 9cm  
11-282 9cm



11-280



11-281



11-282



**1:2 DASTOOR**  
11-290 10cm



**1:2 STRABISMUS**  
11-300 11cm

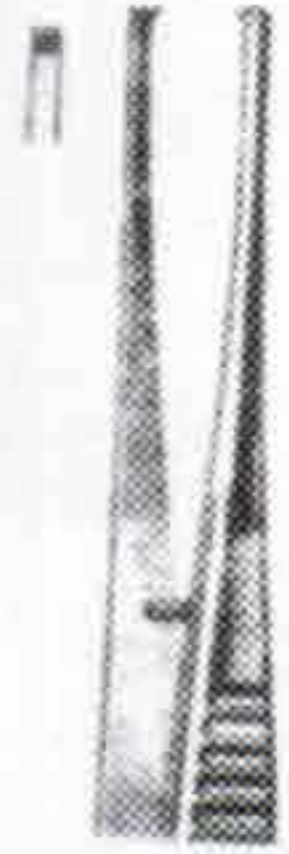

**2:3 STRABISMUS**  
11-301 11cm



**CASTROVILLA**  
11-310 9cm



**WORTH**  
11-320 10cm



**WORTH**  
11-330 10cm



**1:2**  
11-340

**HESS**  
9cm



**1:2**  
11-350



**1:2 FISCHER**  
11-360 7cm



**1:2 FISCHER**  
11-370



# OPHTHALMOLOGY



**ARRUGA**  
11-380 9.5cm



**ELSCHING**  
11-390 10cm

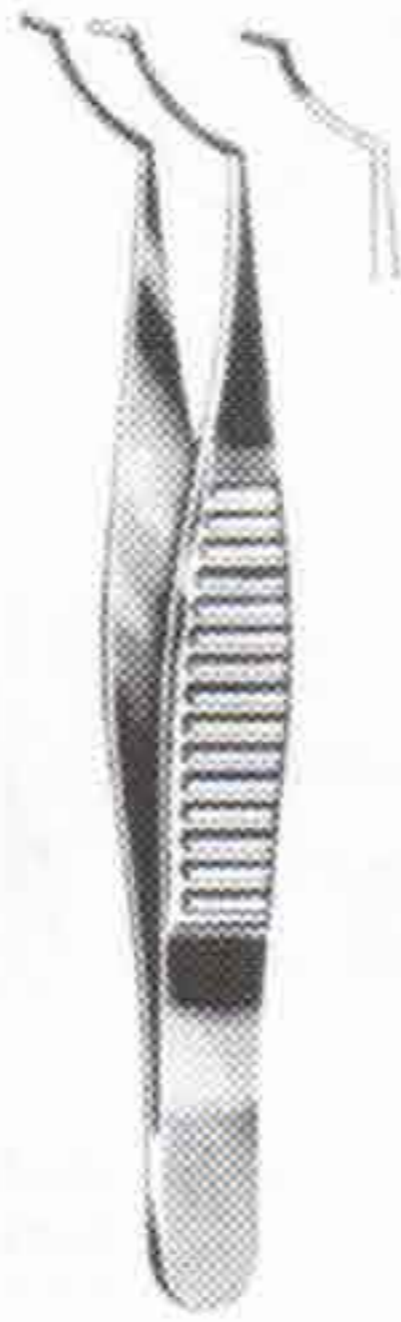

**HESS**  
11-400 6.5cm



11-410 6cm



**FUCHS**  
11-420 7cm



**HESS**  
11-430 6cm



**ELSCHING**  
11-440 11cm



**GRAEFE**  
11-450 11cm



**GRAEFE**  
11-460 11cm



**SCHMIDT-RIMPLEX**  
11-470 11cm



**GRAEFE Serated**  
11-480 10cm 11-483  
11-481 10cm 11-484  
11-482 10cm 11-485

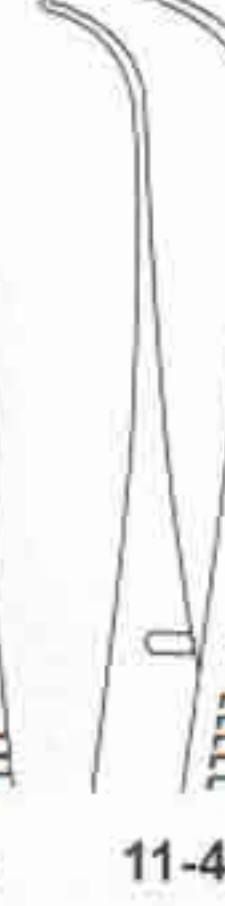

11-480

11-481

11-482

11-483

11-484

11-485



**STR**  
11-490



**GRAEFE**  
7cm



**CUR**  
11-500



**1:2 STR**  
11-510



**GRAEFE**  
7cm



**1:2 STR**  
11-520



**BISHOP-HRRMAN SERRATED** 1:2  
11-530 8.5cm 11-531



**1:2**  
11-540



**HESS** 1:2  
11-550



# EAR SPECULA

Ohrspekula  
Espéculos Auriculares

Spéculms Auriculares  
Specoli Auricolari

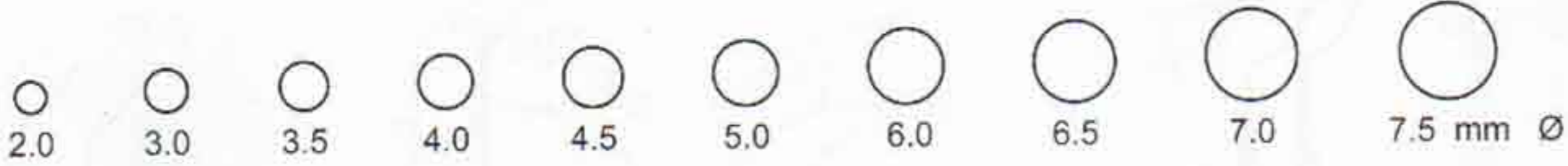

### BOUCHERON

- 12-100 Set of 4
- 12-101 3.5 mm
- 12-102 4.5 mm
- 12-103 5.5 mm
- 12-104 6.5 mm



### PLOITZER

- 12-110 Set of 4
- 12-111 2 mm
- 12-112 3 mm
- 12-113 4 mm
- 12-114 5 mm

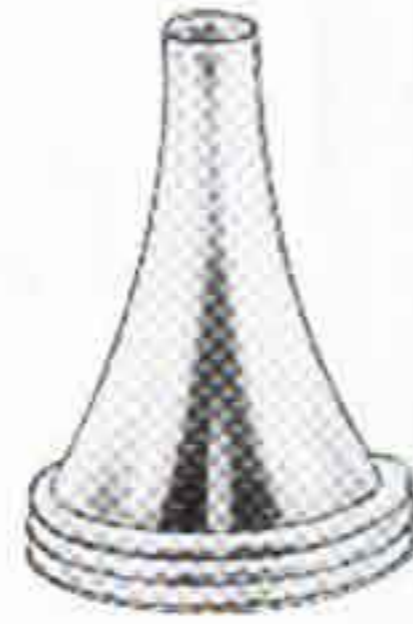

### HARTMANN for children

- 12-120 Set of 3
- 12-121 2 mm
- 12-122 3.5 mm
- 12-123 5 mm



### HARTMANN Set of 4, For Adults

- 12-130 4.0 mm
- 12-131 5.0 mm
- 12-132 6.0 mm
- 12-133 7.5 mm



12-140  
5.3 x 6.5 mm



12-141  
7.5 x 8.5 mm



12-142  
6.5 x 7.5 mm



12-143  
8.5 x 9.5 mm



**ZOLLNER**  
Set of 6, Alu Black



12-144  
9.5 x 10.5 mm



12-145  
10.5 x 11.5 mm



### GRUBER AURAL SPECULA

Black finish, diam, 38 mm

- 12-150 Set of 4
- 12-151 3 mm
- 12-152 4 mm
- 12-153 5 mm
- 12-154 7 mm



### ROSEN

Black finish, slotted round ends 35 mm

- 12-160 Set of 4
- 12-161 3 mm
- 12-162 4 mm
- 12-163 5 mm
- 12-164 7 mm



### ROSEN

slotted round ends  
Black finish, 35 mm

- 12-170 Set of 4
- 12-171 4 mm
- 12-172 5 mm
- 12-173 6 mm
- 12-174 7 mm



### TUMARKIN

Tapered Slot

- | 12-180 | Size | Set of 8 |
|--------|------|----------|
| 12-181 | 0    | 4.5 mm   |
| 12-182 | 1    | 6.5 mm   |
| 12-183 | 2    | 7.0 mm   |
| 12-184 | 3    | 7.5 mm   |
| 12-185 | 4    | 8.0 mm   |
| 12-186 | 5    | 8.5 mm   |
| 12-187 | 6    | 9.0 mm   |
| 12-188 | 7    | 11. mm   |



12-202

### SIEGLE

Single Part:

- 12-200 to 12-201 Diagnostic Head Complete Set Aural magnifier, anastigmatic, complete with:
- 12-202 1 diagnostic head
- 12-203 to 12-205 3 ear specula
- 12-206 1 rubber bulb with rubber tube and connection cone



12-203  
Ear Speculum,  
Ø 6.5 mm



12-204  
Ear Speculum,  
Ø 7 mm



12-205  
Ear Speculum,  
Ø 8 mm



# NASAL TOMPON, CURETTES, TYMPANUM NEEDLE



Nasentamponinzetten, Currettes, Trommelfellnadeln Pincesa à Pansements, Curette, Aiguilles Pour Le Tympan  
 Septumzangen, siebbeinküretten, Aguja Para Timpano Pincas Pour La Cloison Nasal, Curetas, Aghi Per Timpano



**REINER**  
12-210  
Tip Only

**REINER**  
12-211  
Tip Only

**12-212**  
Shield



**12-213** 50CC Complete  
75CC Complete

**12-214** 100CC Complete  
150CC Complete  
With Tip & Shield

- 12-220 Ø 2 mm
- 12-221 Ø 2,5 mm
- 12-222 Ø 3 mm
- 12-223 Ø 4 mm
- 12-224 Ø 5 mm

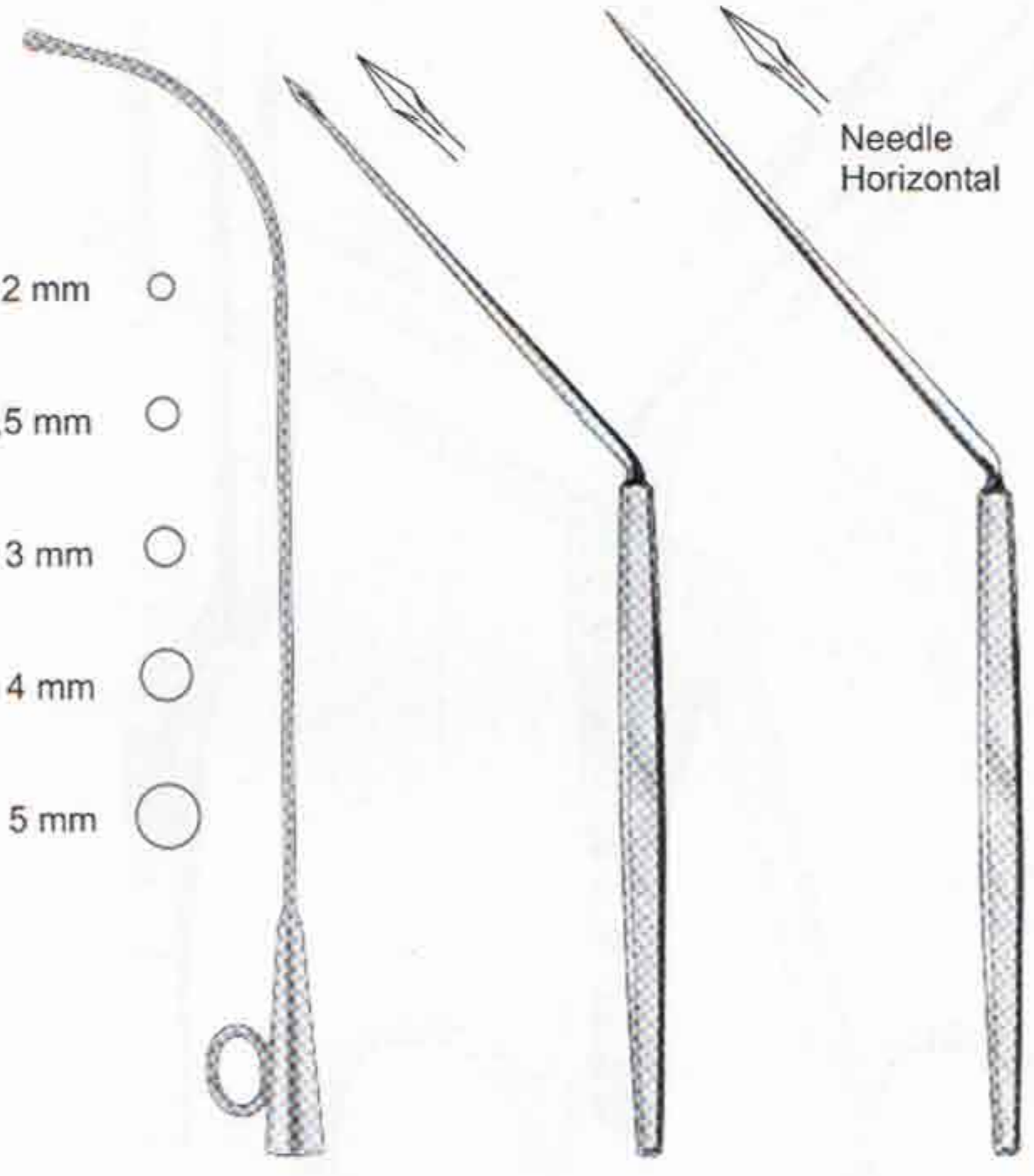

**Hartmann**  
Eustachian  
Catheters

**POLITZER**  
12-230  
16.5 cm, 6 1/2"

**POLITZER**  
12-240  
16.5 cm, 6 1/2"

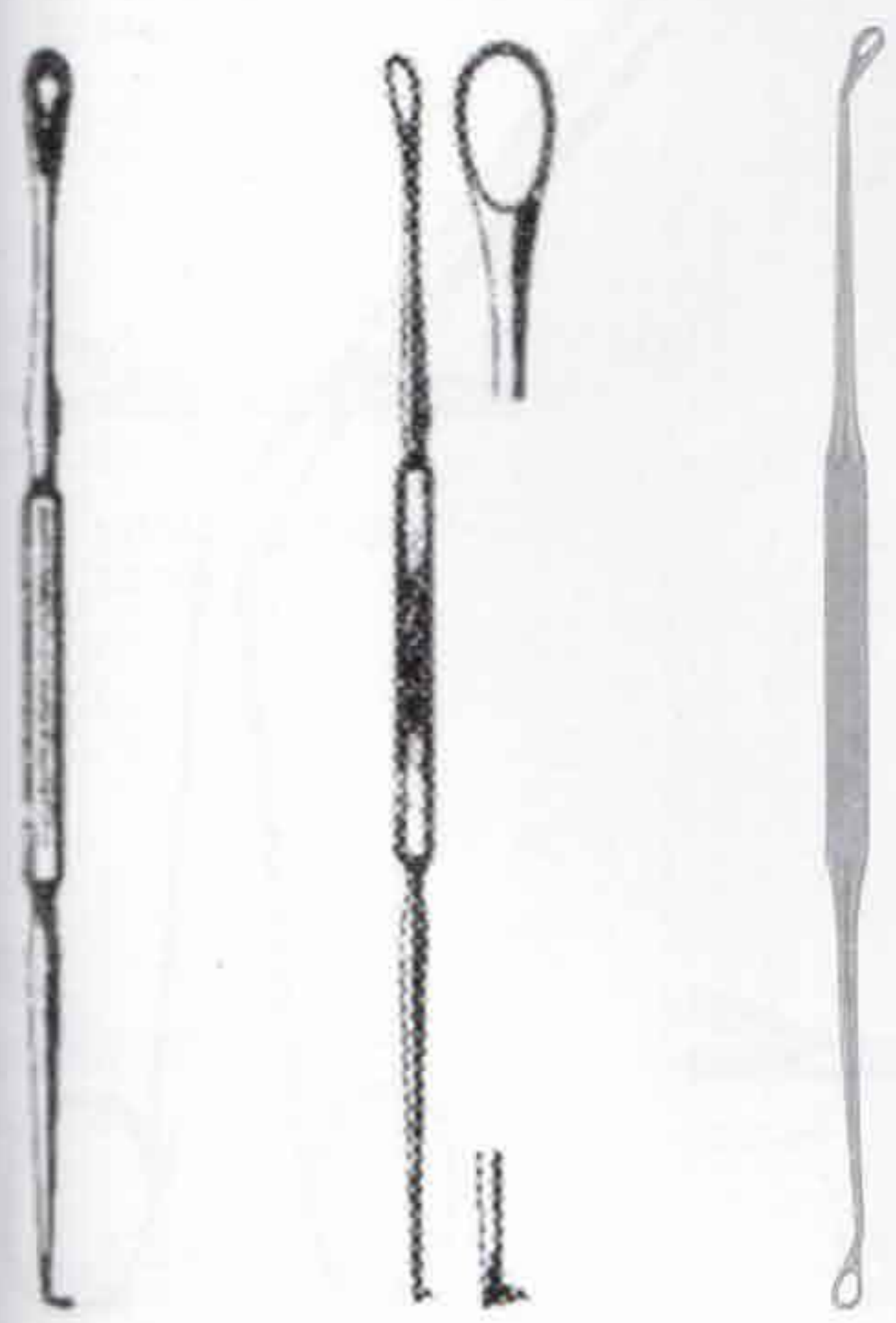

**GROSS**  
12-250

**GROSS**  
12-260

**COAKLEY SINUS**  
CURETTES

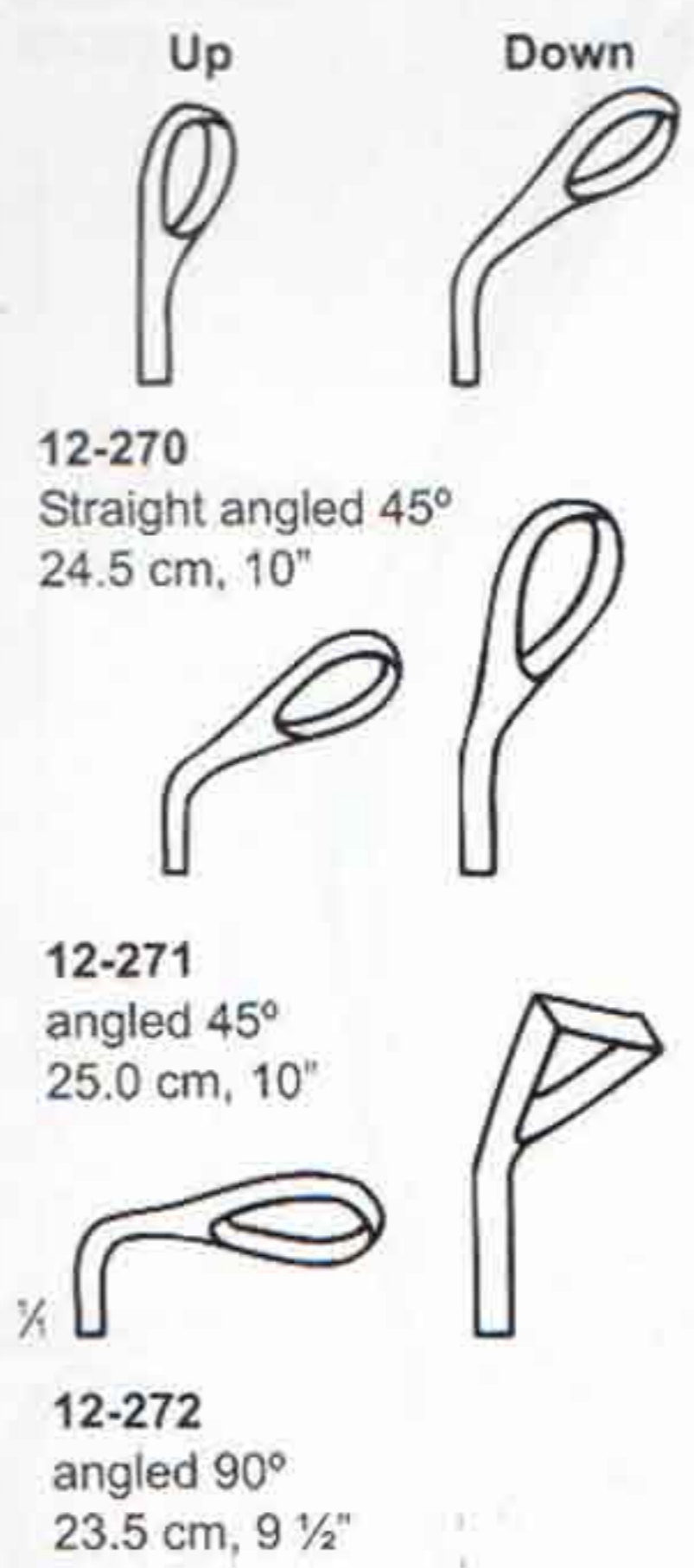

**12-270**  
Straight angled 45°  
24.5 cm, 10"

**12-271**  
angled 45°  
25.0 cm, 10"

**12-272**  
angled 90°  
23.5 cm, 9 1/2"



**KRAUSE-VOSS**  
12-280  
25 cm, 10"  
Nasal Polypus Snare,  
knee shaped, complete



**WILDE**  
12-290  
Nasal Polypus Snare,  
bayonet-shaped



# EAR POLYPUS FORCEPS, SEPTUM FORCEPS

Ohrpolypenzangen, Nasenpolypenzangen  
 Pinzas Para Pólipos Auriculares, Pinzas Para Pólipos Nasaes

Pinces Pour Polypes Auriculaires, Pinces À Polypes Nasales  
 Pinze Per Polipi Auricolari, Pinze Per Polipi Nasali



**TROELTSCH**  
 12-300  
 11 cm, 4 1/2"



**LUCAE**  
 12-310  
 14 cm, 5 1/2"

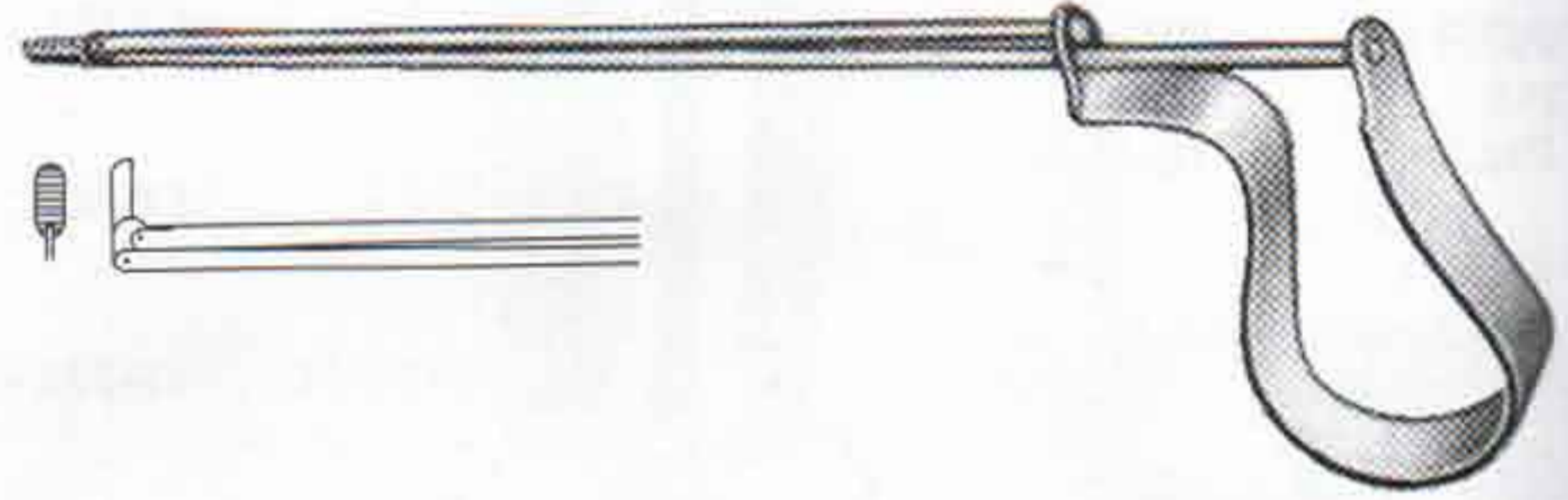

**QUIRE**  
 12-320  
 12 cm, 4 3/4"

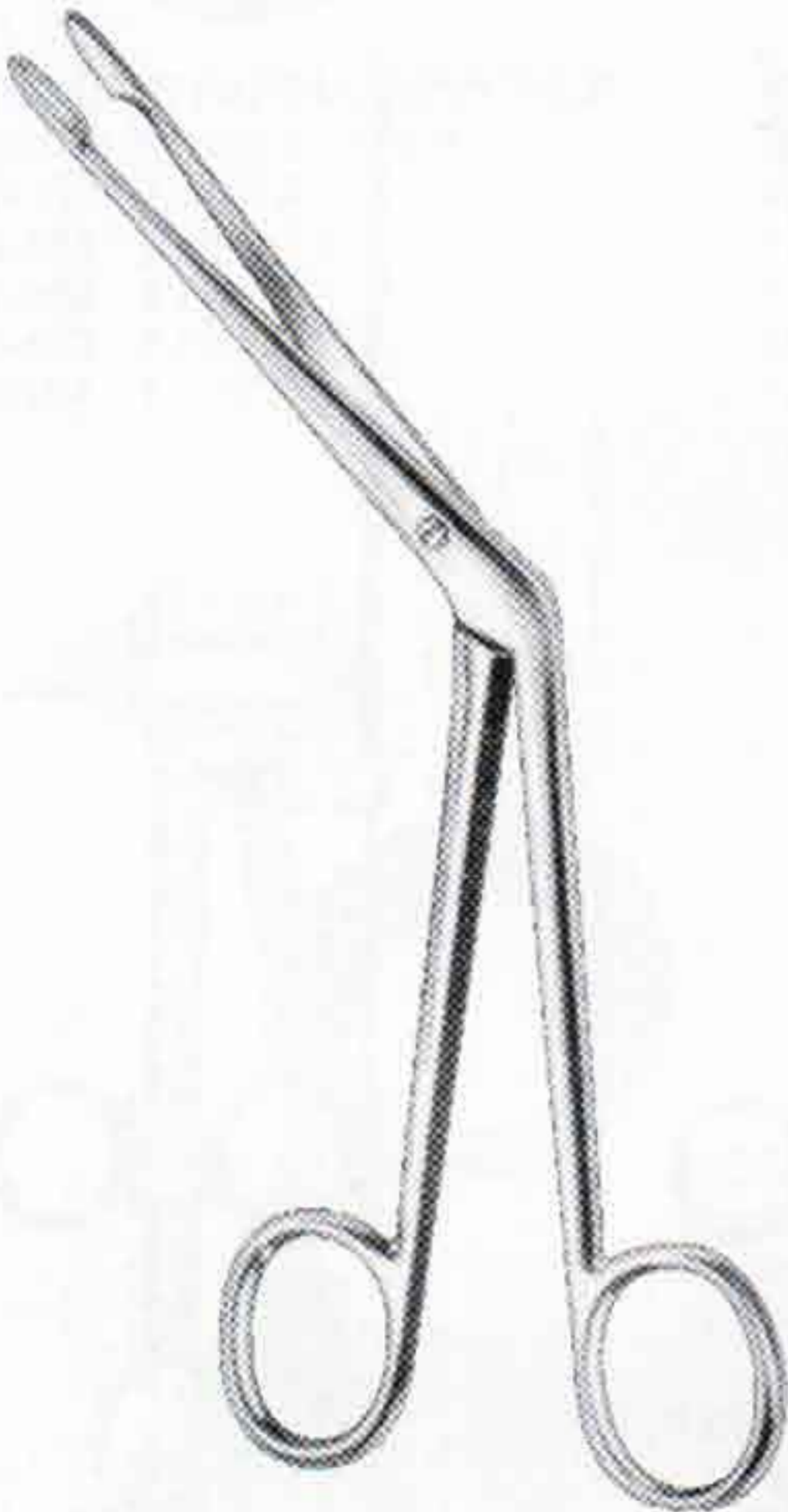

**HARTMANN**  
 12-330  
 16 cm, 6 1/4"  
 12-331  
 20 cm, 8"

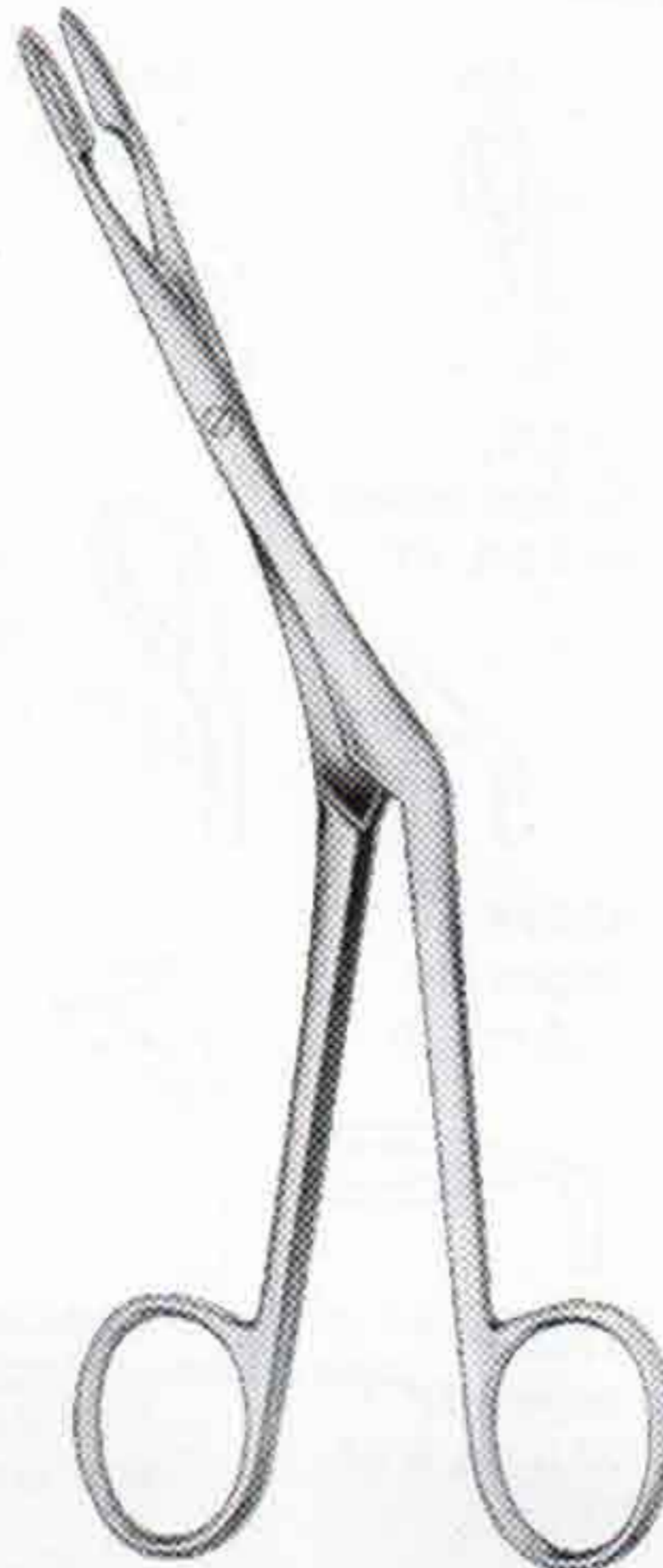

**HEYMANN-KNIGHT**  
 12-340  
 18 cm, 7"

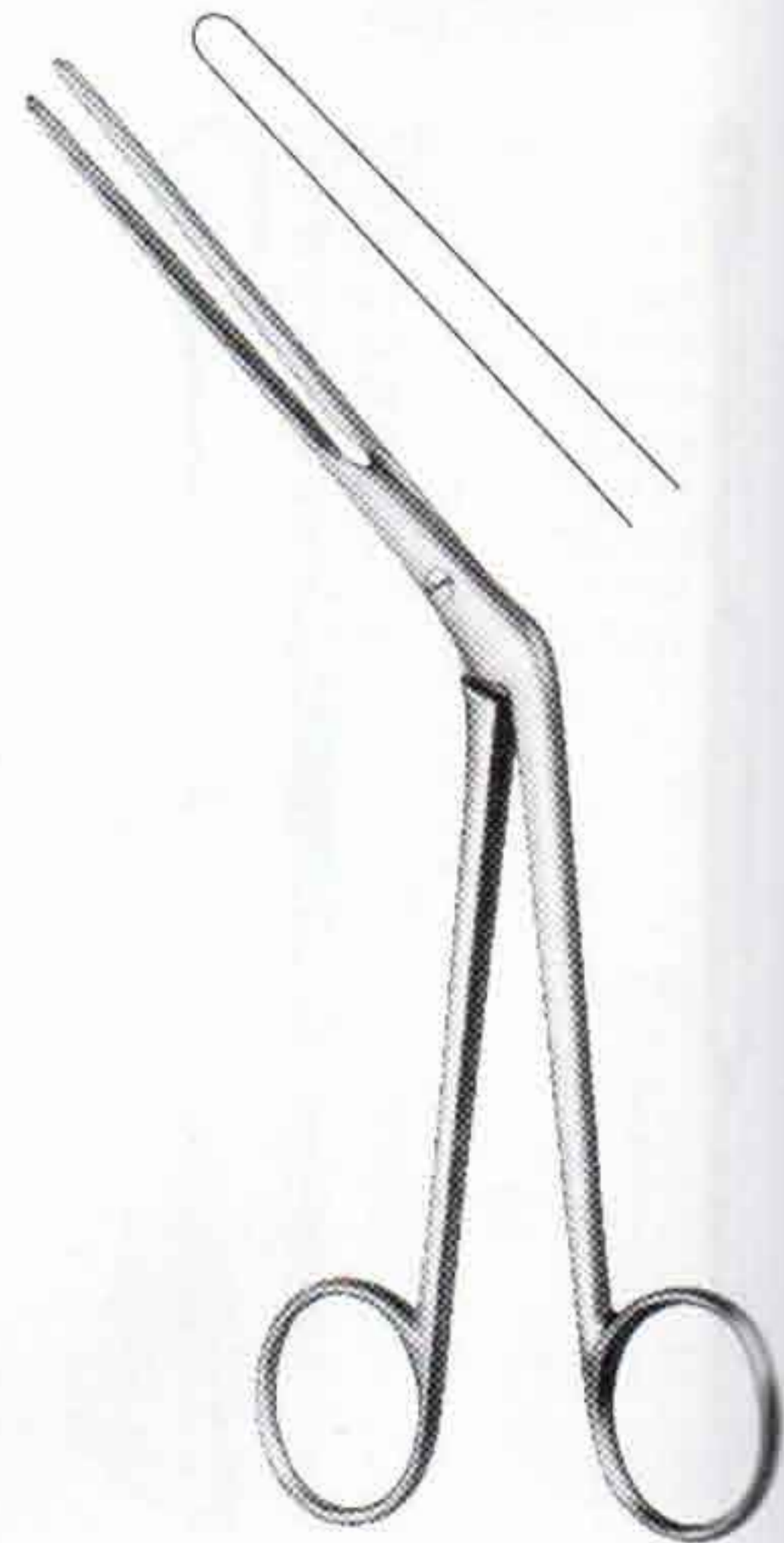

**LUBET-BARBON**  
 12-350  
 20 cm, 8"



# ALLIGATOR EAR FORCEPS

Alligator-ohrfaßzangen  
Pincas crocodiles à oreilles

Pinze alligatore per orecchi  
Pinzas de boca de cocodrilo para el oído



**HARTMANN-WULLSTEIN**  
12-360



**HARTMANN-WULLSTEIN**  
12-361



**HARTMANN**  
12-362  
12-363



**HARTMANN**  
12-364  
12-365



**HARTMANN-NOYES**  
12-366



**DUCKBILL**  
12-367



**WEINGÄRTNER**  
12-368



**HARTMANN**  
12-369 = 2.0 mm  
12-370 = 2.5 mm  
12-371 = 3.0 mm



**HARTMANN**  
12-372 = 2.0 mm  
12-373 = 2.5 mm  
12-374 = 3.0 mm



**STRÜMPEL**  
12-375



**HARTMAN**  
12-376



**HARTMANN**  
12-377



**HARTMANN-HOFFMANN**  
12-378

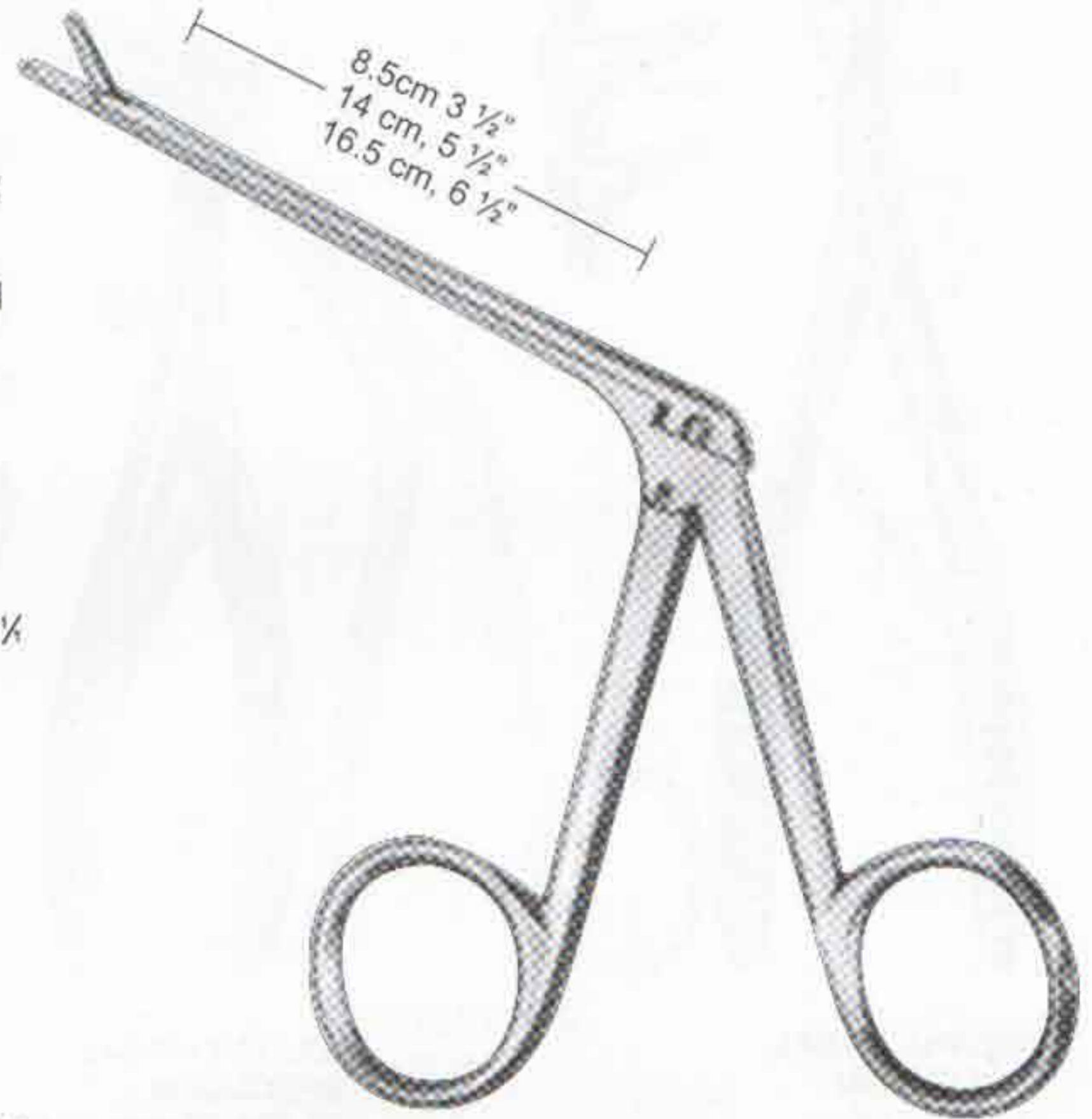



# NASAL SPECULUM

Nasenspekula  
Especulos Nasaes

Spéculums Nasaux  
Specoli Nasali

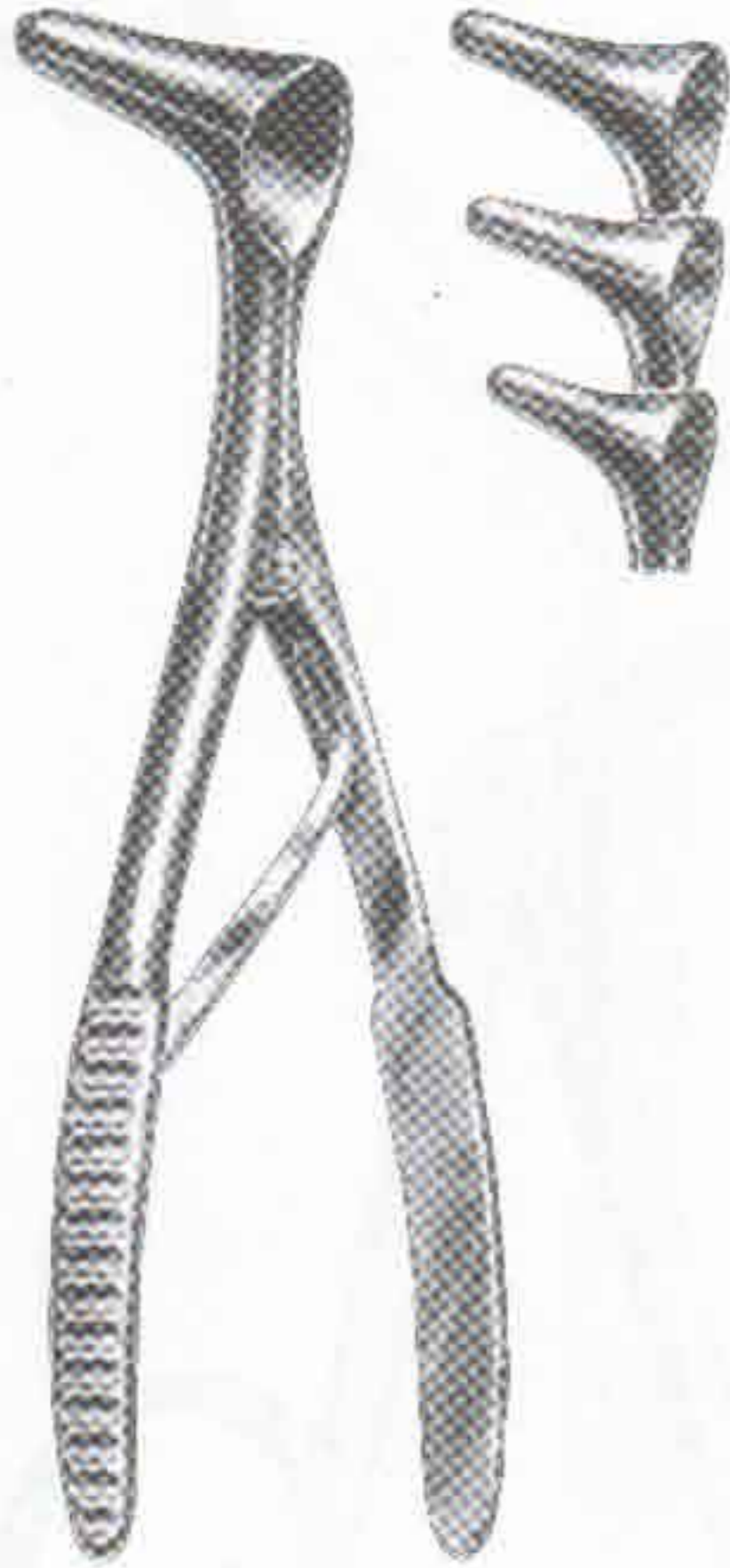

**VIENNA NASAL SPECULUM**  
12-390 - Infant  
12-391 - Child  
12-392 - Adult  
14 cm, 5 1/2"

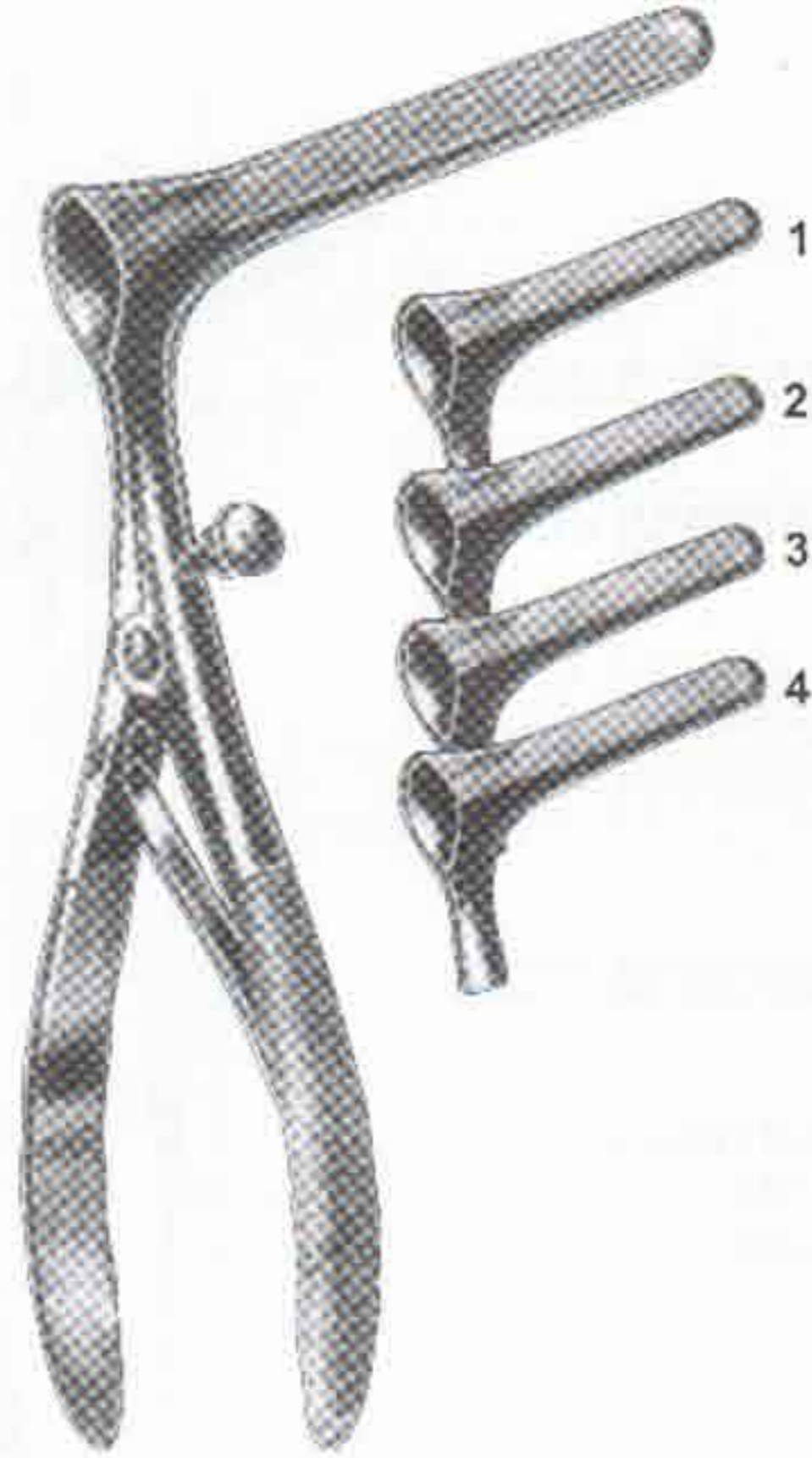

**KILLIAN NASAL SPECULUM**  
12-400 35 mm 2" Small blade  
12-401 50 mm 3" Medium blade  
12-402 75 mm  
12-403 90 mm  
13 cm, 5 1/4"

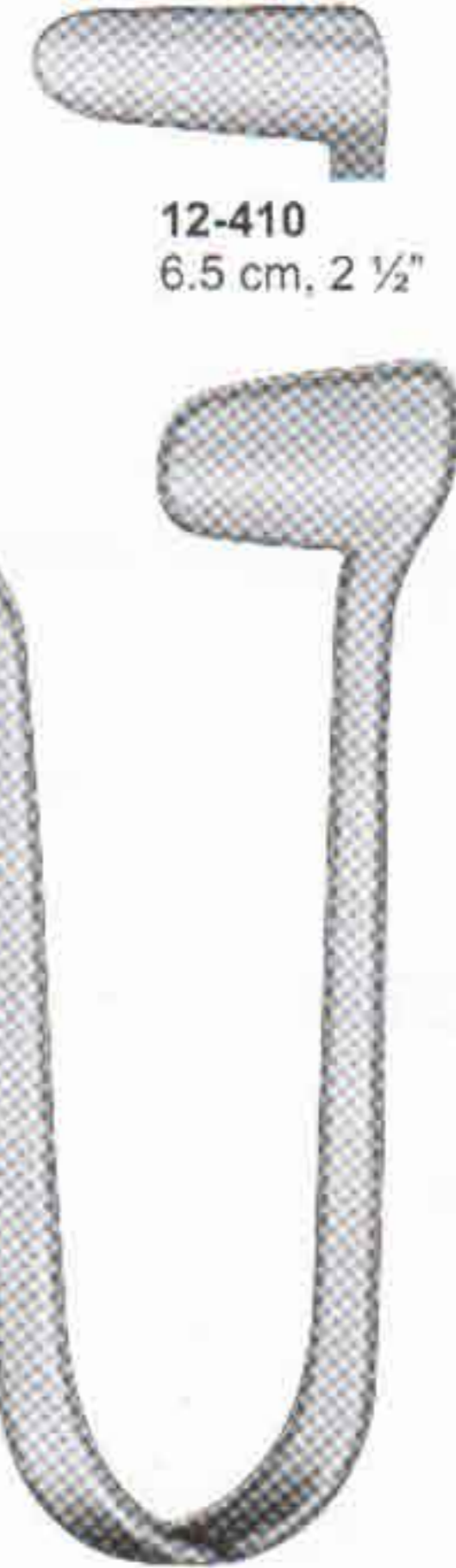

**THUDICHUM (Golfsmith)**



12-410  
6.5 cm, 2 1/2"

12-411  
6.5 cm, 2 1/2"

12-412  
6.5 cm, 2 1/2"

12-413  
6.5 cm, 2 1/2"

12-414  
6.5 cm, 2 1/2"

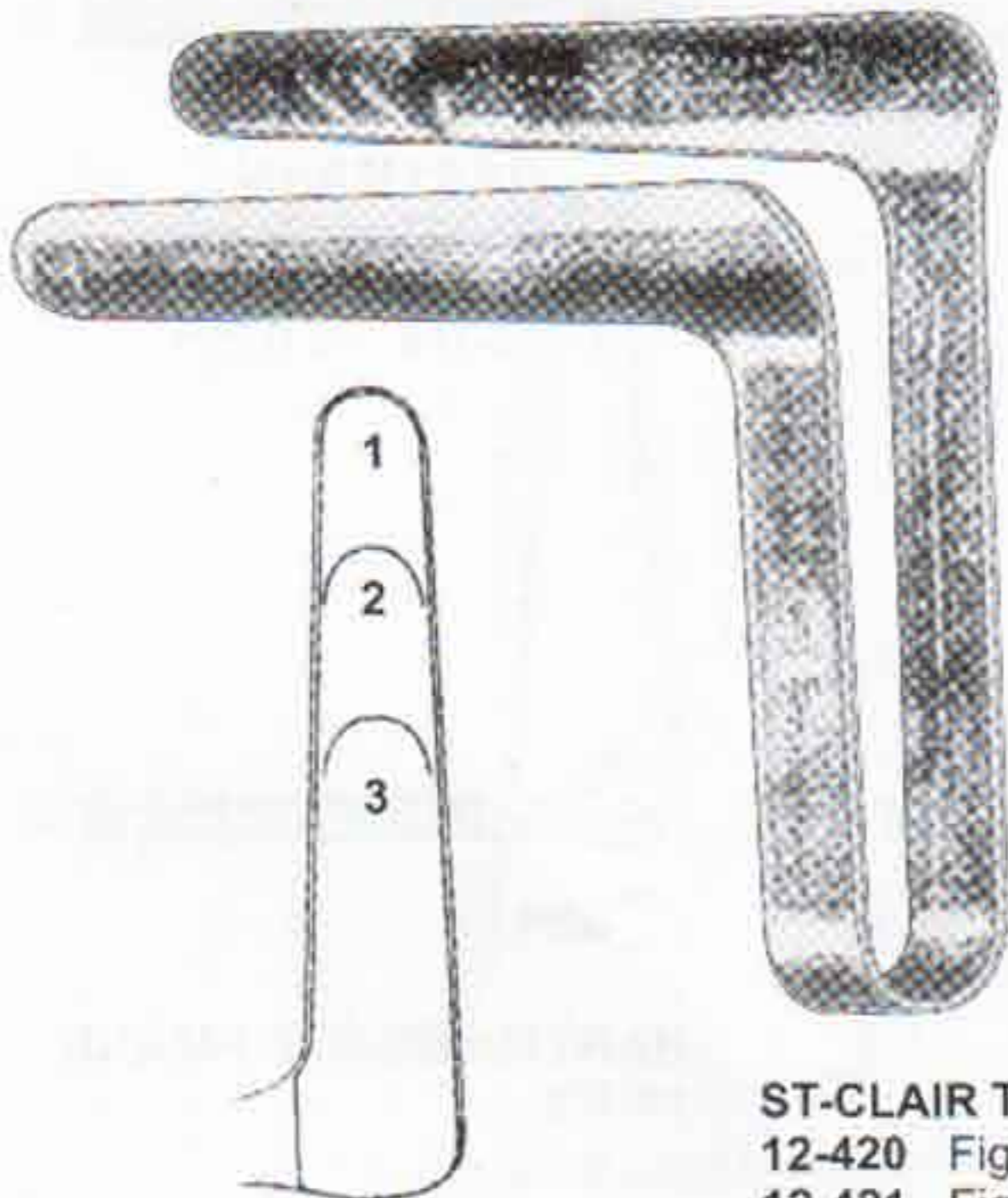

**ST-CLAIR THOMSON**  
12-420 Fig 1  
12-421 Fig 2  
12-422 Fig 3

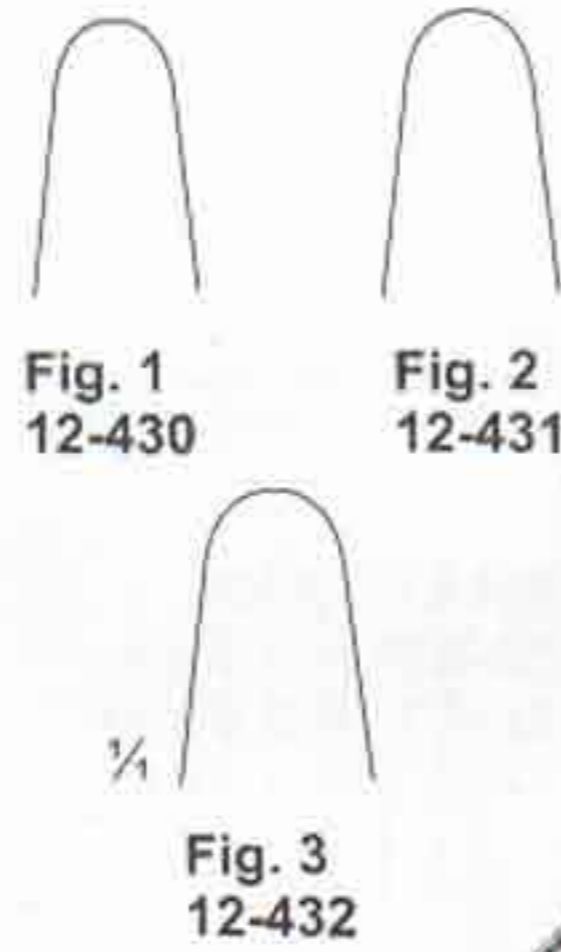
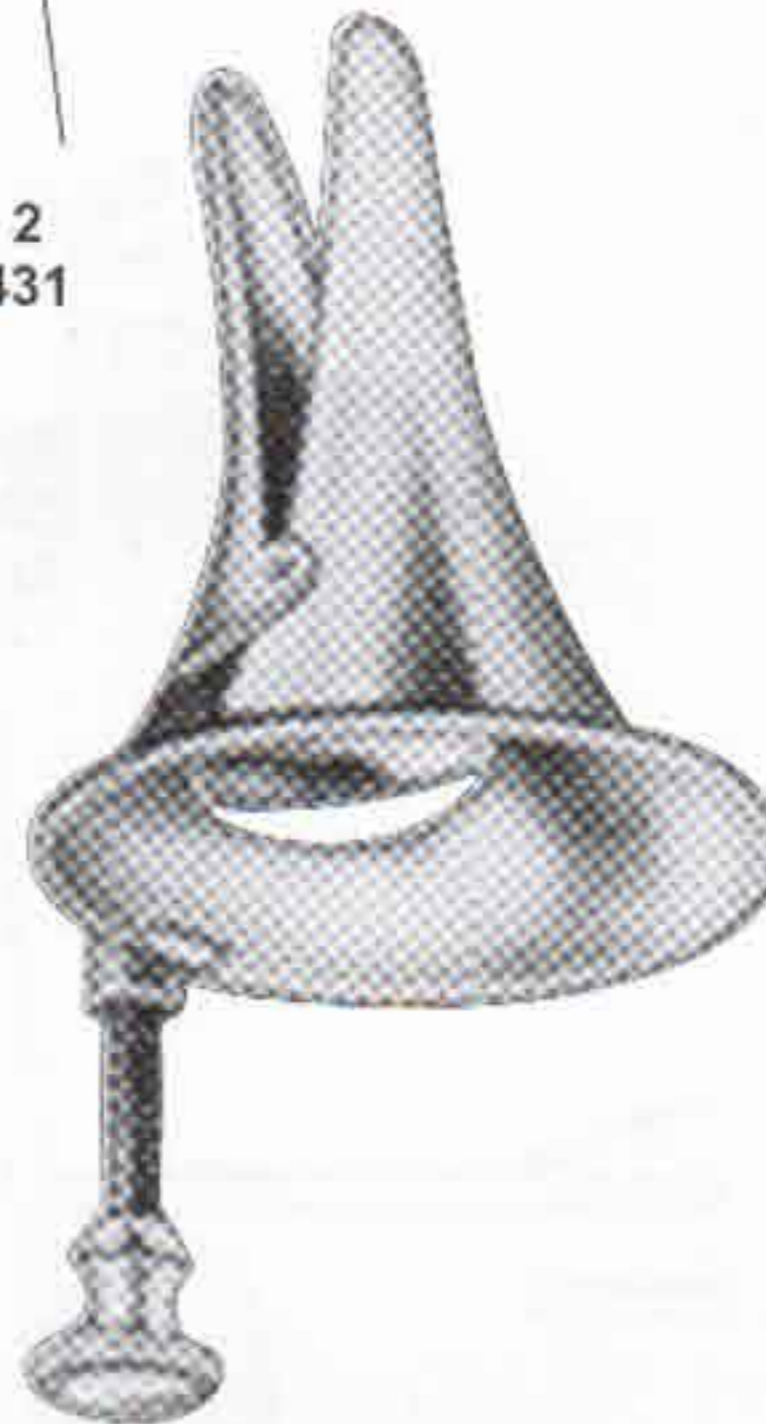

Fig. 1  
12-430

Fig. 2  
12-431

Fig. 3  
12-432



**VOLTOLINI (Duplay)**

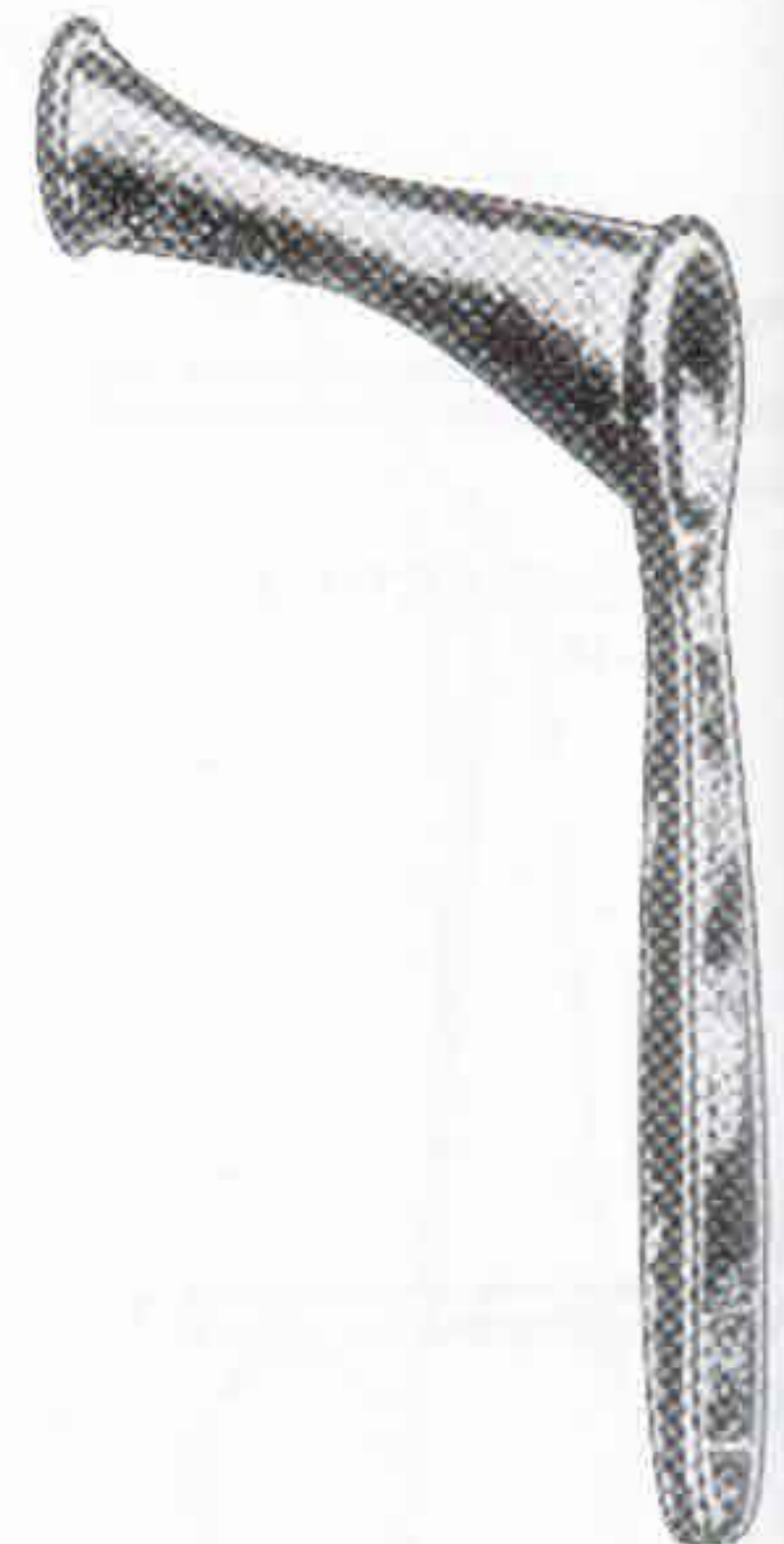

**YANKAUER**  
12-440  
19cm



# SEPTUM FORCEPS, TONSIL PUNCHES



Nasenpolyenzangen, Tonsillenzangen  
Pinzas Para Pólipos Nasaes, Pinzas Para Amígdalas

Pinces À Polypes Nasaux, Pinces Pour Amygdalas  
Pinze Per Polipi Nasali, Pinze Per Tonsille

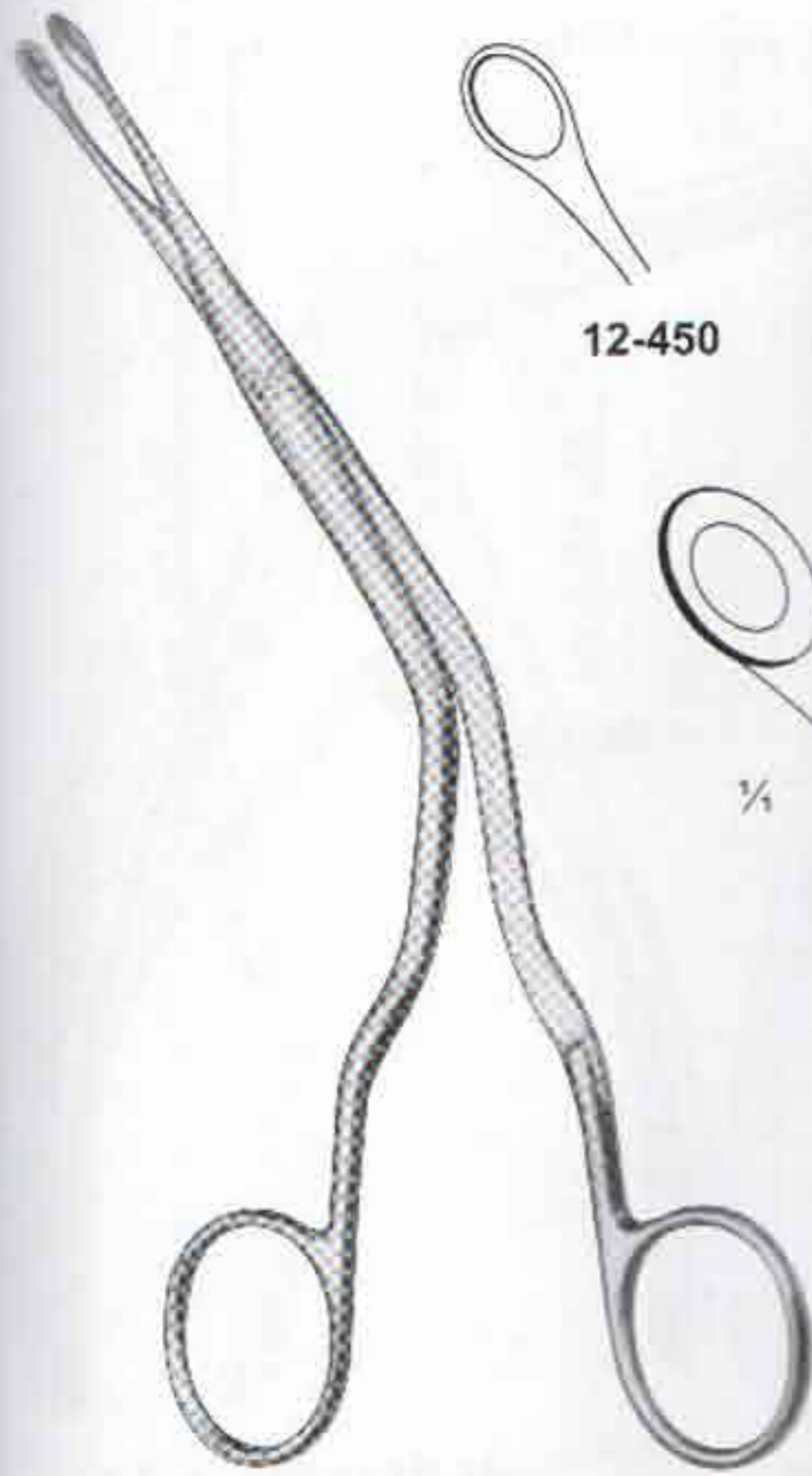

**LUC**  
20 cm, 8"



**BRUENINGS**  
19 cm, 7 1/2"

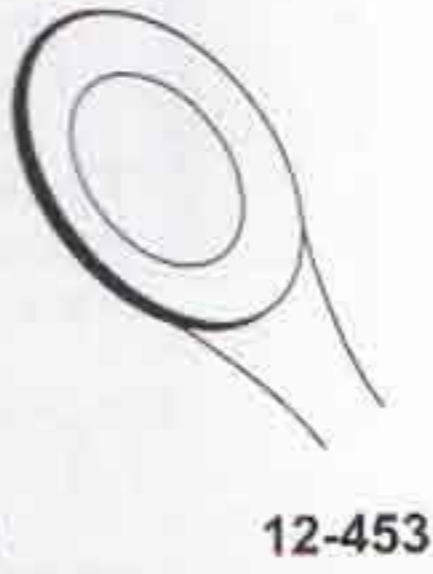
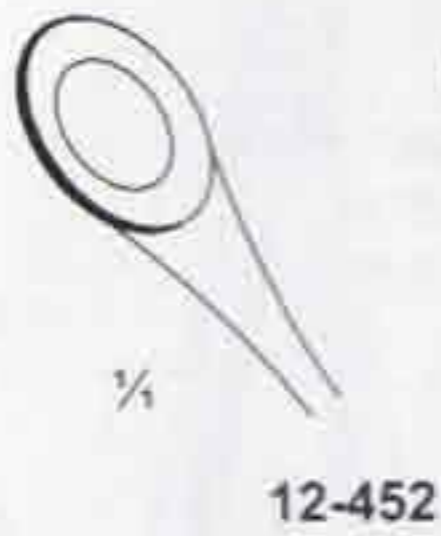

**12-470** 1/4  
13 cm, 5 1/4" Straight  
5 x 10 mm

12.5 cm/5"



**WATSON-WILLIAMS**  
12-471

12.5 cm/5"



**WATSON-WILLIAMS**  
12-472

12.5 cm/5"



**WATSON-WILLIAMS**  
12-473

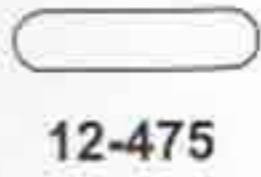

12.5 cm/5"



**GRUENWALD-HENKE** 1/4  
Nasal Cutting Forceps

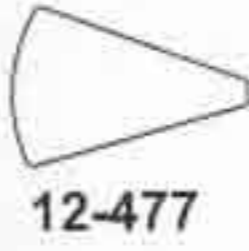

12.5 cm/5"



**SCHMEDEN**  
Nasal Cutting Forceps  
12-478

12.5 cm/5"



**STRUYCKEN**  
Nasal Cutting Forceps  
12-479

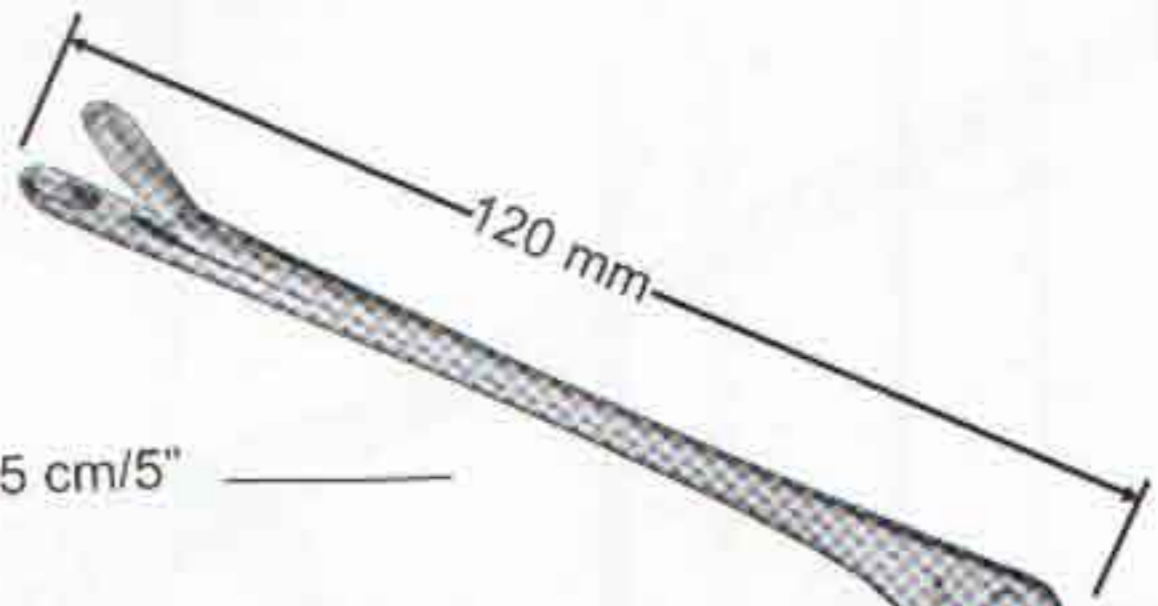

12.5 cm/5"



**HARTMANN**  
Nasal Cutting Forceps



**TAKAHASHI**  
19 cm, 7 1/2"



# SEPTUM FORCEPS, TONSIL PUNCHES

Nasenpolyenzangen, Tonsillenzangen  
Pinzas Para Pólipos Nasaes, Pinzas Para Amígdalas

Pinces À Polypes Nasaux, Pinces Pour Amygdalas  
Pinze Per Polipi Nasali, Pinze Per Tonsille

2.0 mm    3.0 mm    3.5 mm

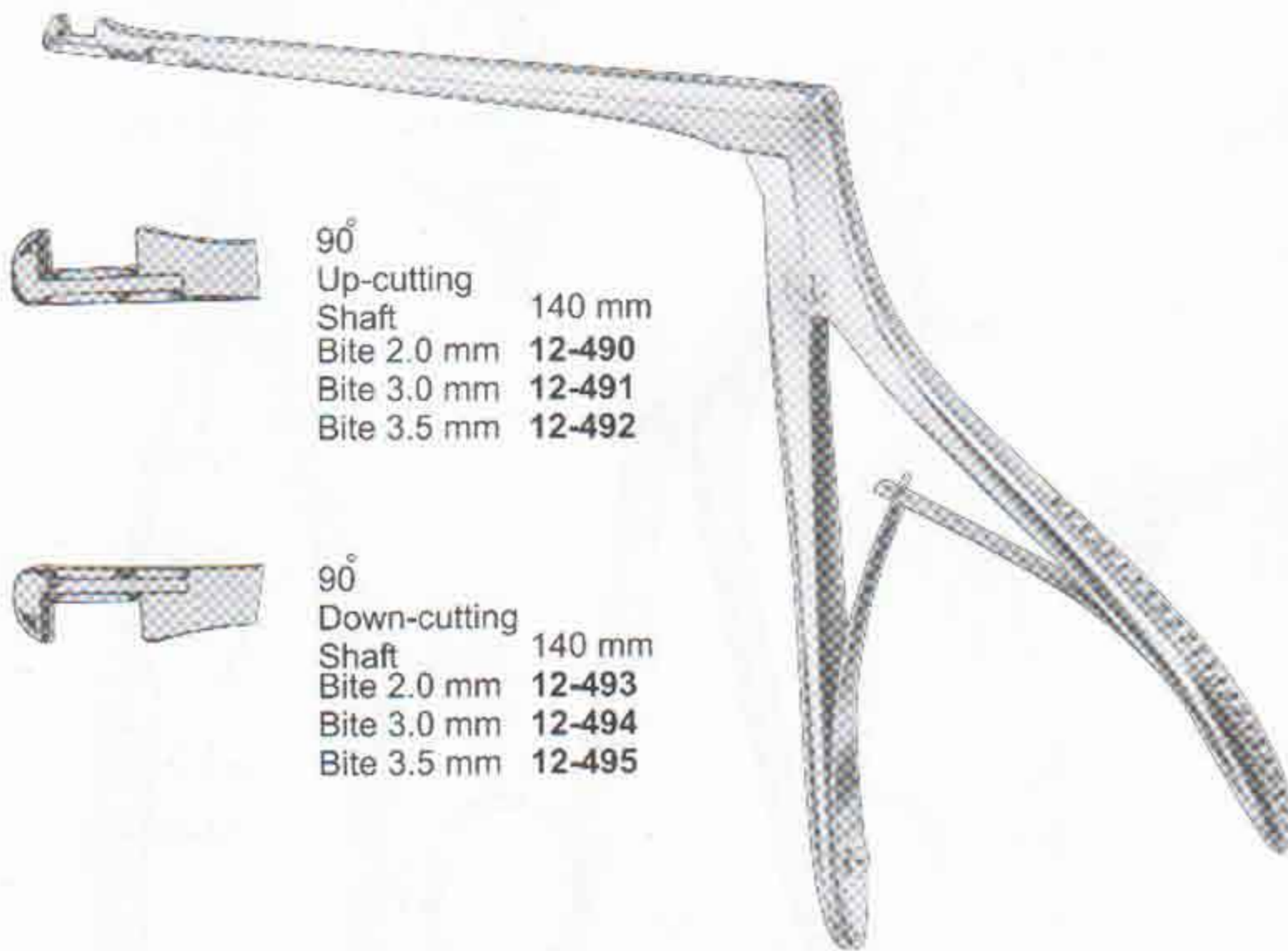

90°  
Up-cutting  
Shaft 140 mm  
Bite 2.0 mm 12-490  
Bite 3.0 mm 12-491  
Bite 3.5 mm 12-492

90°  
Down-cutting  
Shaft 140 mm  
Bite 2.0 mm 12-493  
Bite 3.0 mm 12-494  
Bite 3.5 mm 12-495

**HAJEK-KOFLER**

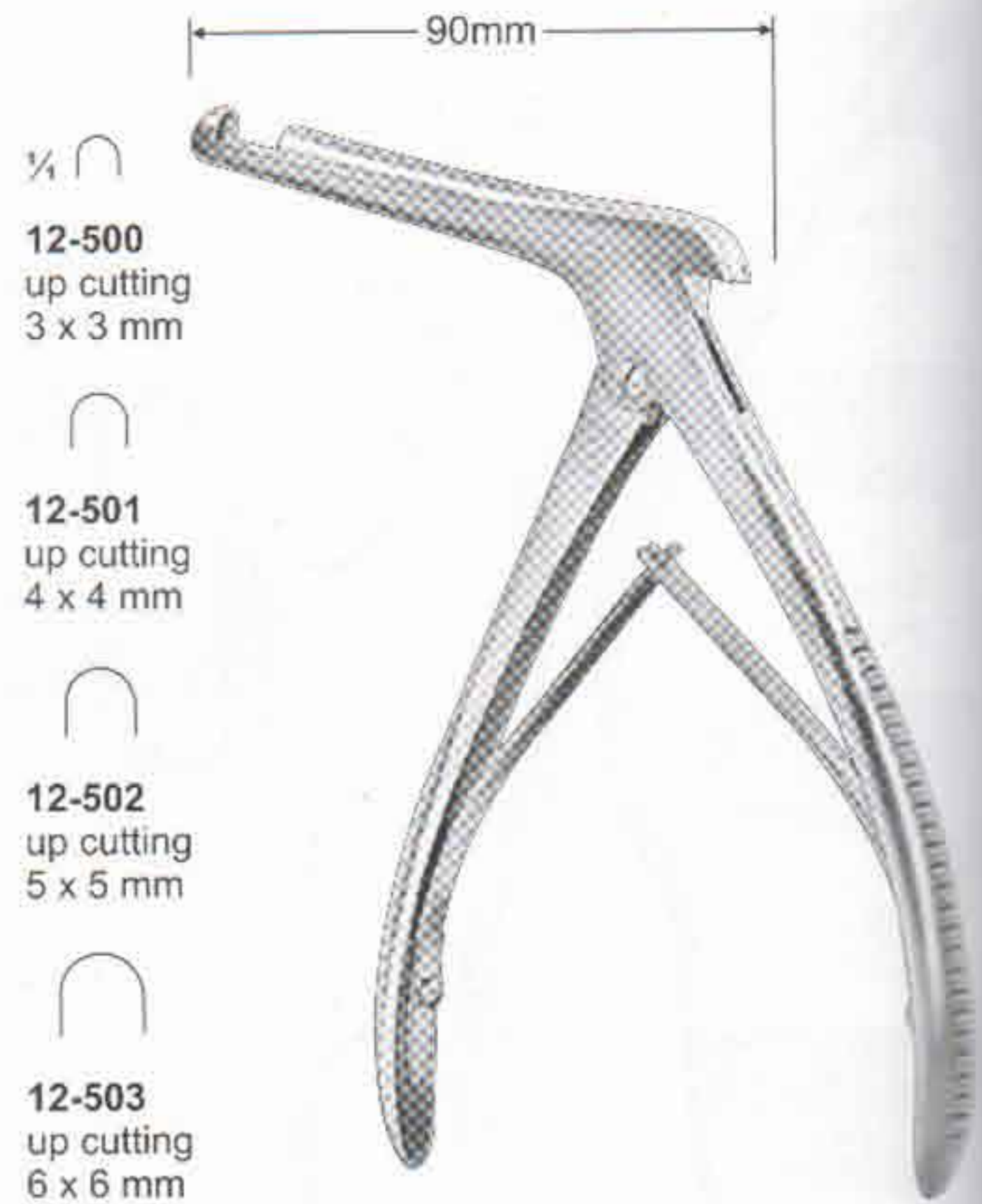

1/4  
12-500  
up cutting  
3 x 3 mm

12-501  
up cutting  
4 x 4 mm

12-502  
up cutting  
5 x 5 mm

12-503  
up cutting  
6 x 6 mm

**KERRISON**  
41-148  
9 cm, 3 1/2"

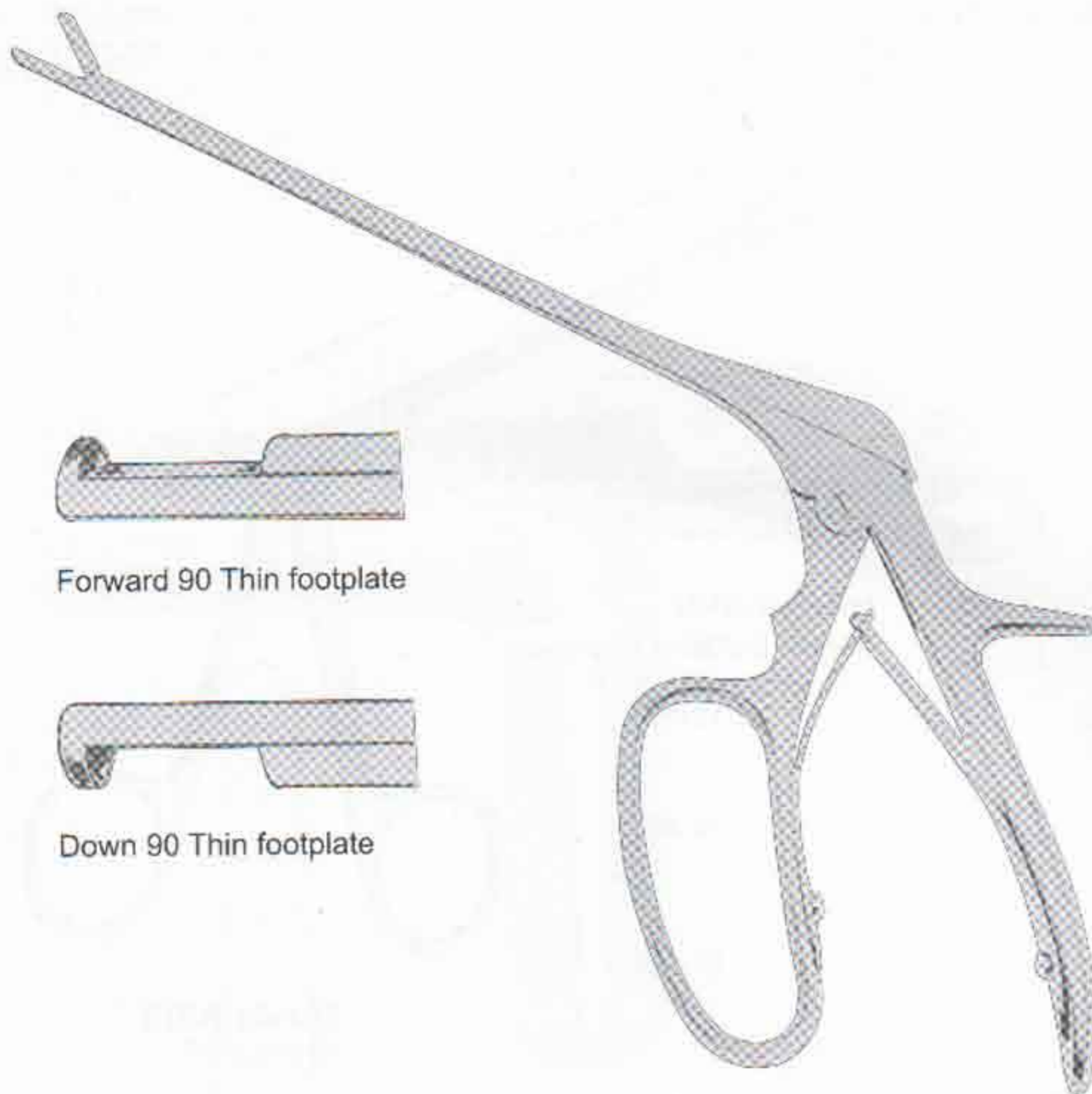

Forward 90 Thin footplate



Down 90 Thin footplate

**FERRIS - SMITH**  
12-510



12-520  
19 cm, 7 1/2"  
Double Action  
5 x 15mm tip

**JANSEN-MIDDLETON**



# SEPTUM FORCEPS, SEPTUM KNIVES, CURETTES



Septumzangen, Septummesser, Ohrküretten

Pinces Pour La Cloison Nasale, Bistouris Pour La Cloison Nasale, Curettes

Septumrichtzangen, Cuchillos Para Tabique Nasal, Curettes

Pinze Per il Setto Nasale, Bisturi Per Il Setto Nasale, Cuette



**ASCH**  
12-530  
23 cm, 9"



1/4  
**12-540**  
right



**12-541**  
left

**WALSHAM**  
21 cm, 8 1/4"



**BRUNINGS**  
12-550  
15.5 cm, 6 1/4"  
Septatome



**FREER**  
12-560  
15 cm, 6"



**FREER**  
12-570  
15.5 cm, 6 1/4"  
Mucous Knife

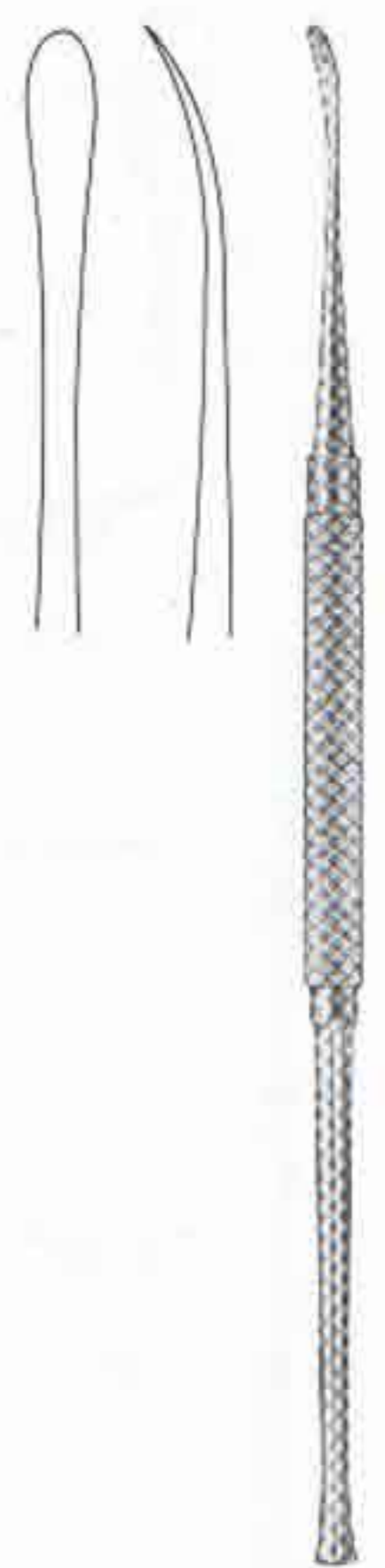

**FREER**  
12-580  
19 cm, 7 1/2"  
Respiratory sharp  
4 mm



**FREER**  
12-590  
19 cm, 7 1/2"  
Respiratory sharp  
4 mm



**BUCK**  
16.5 cm, 6 1/2"



**12-600**  
Blunt  
**12-601**  
Sharp

**12-602**  
Blunt  
**12-603**  
Sharp

**12-604**  
Blunt  
**12-605**  
Sharp

**12-606**  
Blunt  
**12-607**  
Sharp

1/4  
**12-608**  
Blunt  
**12-609**  
Sharp

**12-610**  
Blunt  
**12-611**  
Sharp

**12-612**  
Blunt  
**12-613**  
Sharp

**12-614**  
Blunt  
**12-615**  
Sharp



**BALLENGER**  
12-620 4 x 3 mm  
12-621 5 x 4 mm  
12-622 6 x 5 mm  
20 cm, 8"  
Swivel Knife,  
bayonet-shaped



3 mm



4 mm



1/4  
5 mm



# SEPTUM CHISELS, SEPTUM GOUGES

Septummeißel, Septum-Hohlmeißel  
Cinceles Para Tabique Nasal, Gubias Para Tabique Nasal

Ciseaux-burins Pour La Cloison Nasale, Gouges Pour La Cloison Nasale  
Scalpello Per il Setto Nasale, Sgorbie Per il Setto Nasale



**FREER**  
12-630  
16 cm, 6 1/4"  
4 mm wide  
Septum Chisel,  
straight



**FREER**  
12-640  
16 cm, 6 1/4"  
4 mm wide  
Septum Chisel,  
curved



**FREER**  
12-650  
15 cm, 6"  
6 mm wide  
Septum Gouge,  
straight

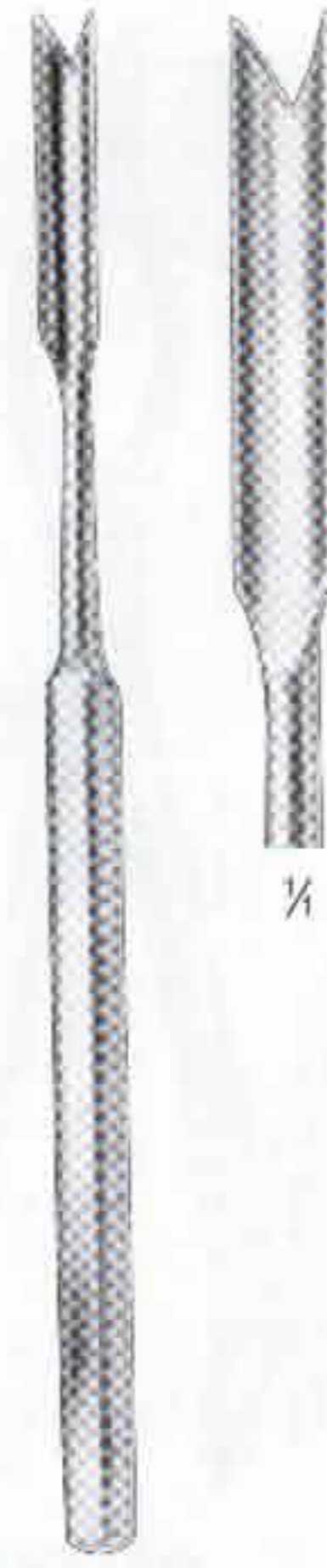

**BALLENGER**  
12-660  
15.5 cm, 6"  
6 mm wide  
Septum Gouge



**KILLIAN**  
12-670  
17 cm, 6 3/4"  
5 mm wide  
Septum Gouge



**FREER**  
12-680  
19cm 7 1/2"  
blunt



**FREER**  
12-690  
18cm 7"  
sharp



**EICKEN-KILLIAN**  
12-700  
3mmØ



**KILLIAN**  
12-710  
1.5cmØ



**HARTMANN**  
12-720  
1.5cmØ

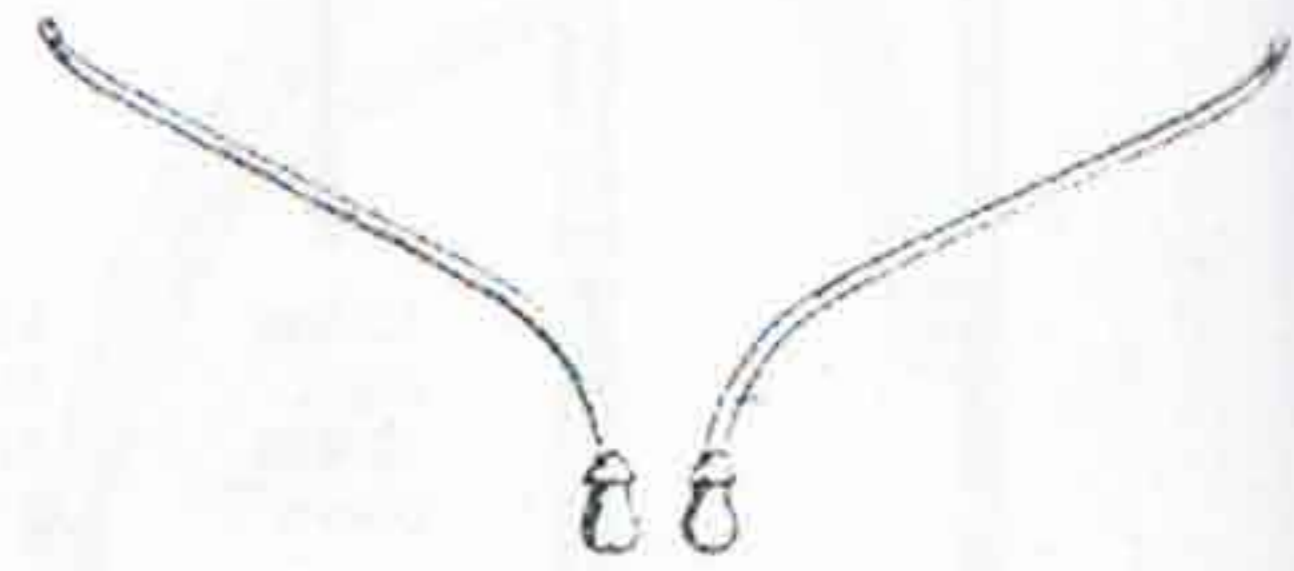

**HARTMANN**  
12-730 2mmØ  
12-731 2.5mmØ  
12-732 3mmØ



# ADENOID CURETTES

Ringmesser  
Cuchillos Para Adenoidse

Couteaux à Végétations Adenoïdales  
Coltelli Per Vegetazioni Adenoidee



12-740



12-741



12-742



12-743



12-744



12-745



12-750



12-751



12-752



12-753

**Beckmann**  
22 cm, 8 3/4"

**ST. CLAIR-THOMSON**  
21cm, 8 1/4"



12-760



12-761



12-762

**LA FORCEPS**  
Adenotomes  
23 cm, 9"

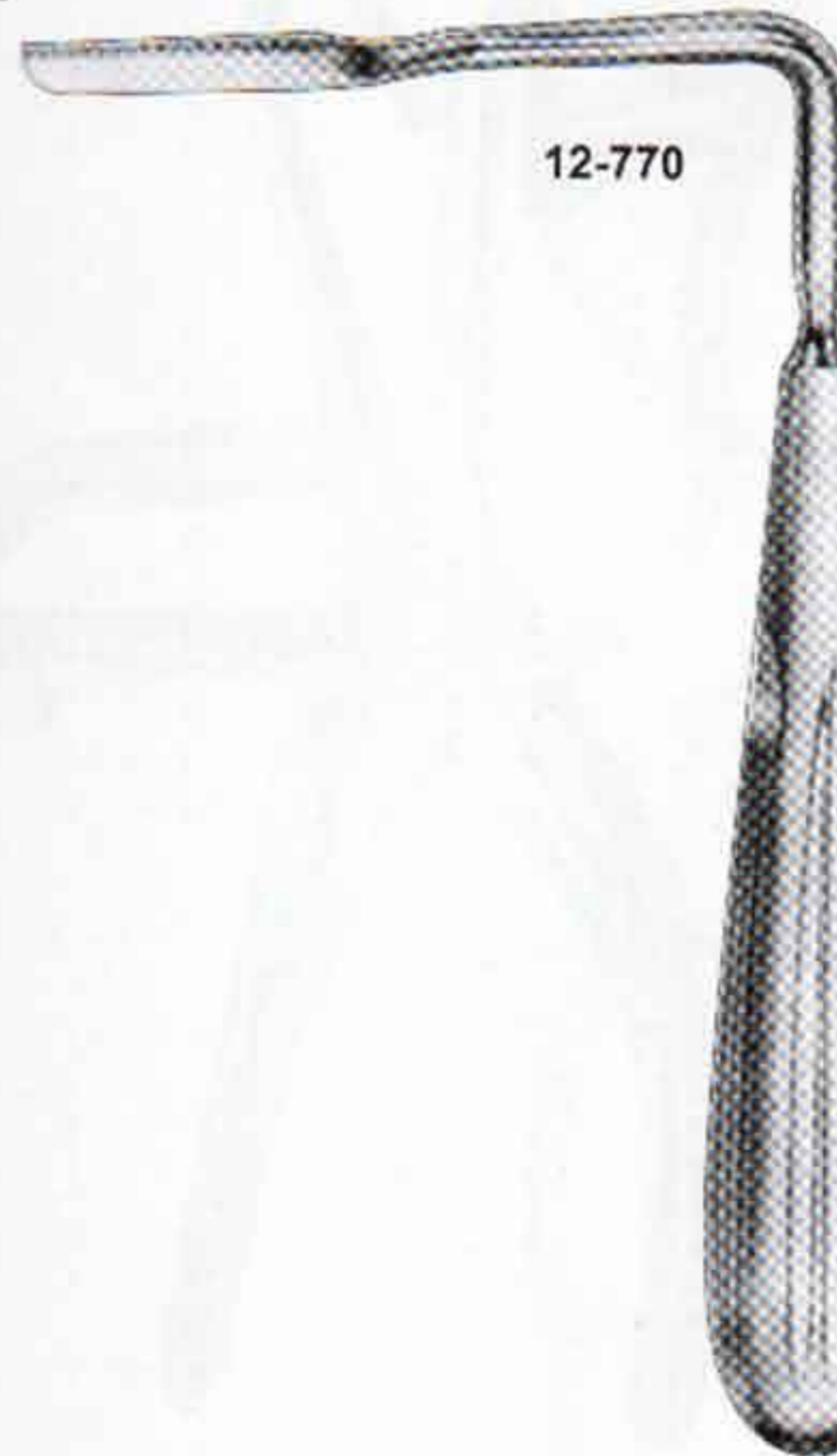

12-770



12-771

**JOSEPH**



# MOUTH GAG, LIP & CHEEK RETRACTORS

Mundsperrer, Lippen- u Wangenhalter  
Abrebocas, Separadores Para Labios y Mejillas

Ouvre-bouche, Ecarteurs Des Lèvres et Joues  
Apribocca, Separatori Per Labbra e Guancia



**MOLT**  
12-780  
11 cm, 4 1/2"



**DOYEN-COLLIN**  
12-790 12 cm, 5"  
12-791 14 cm, 5 1/2"  
Mout Gag

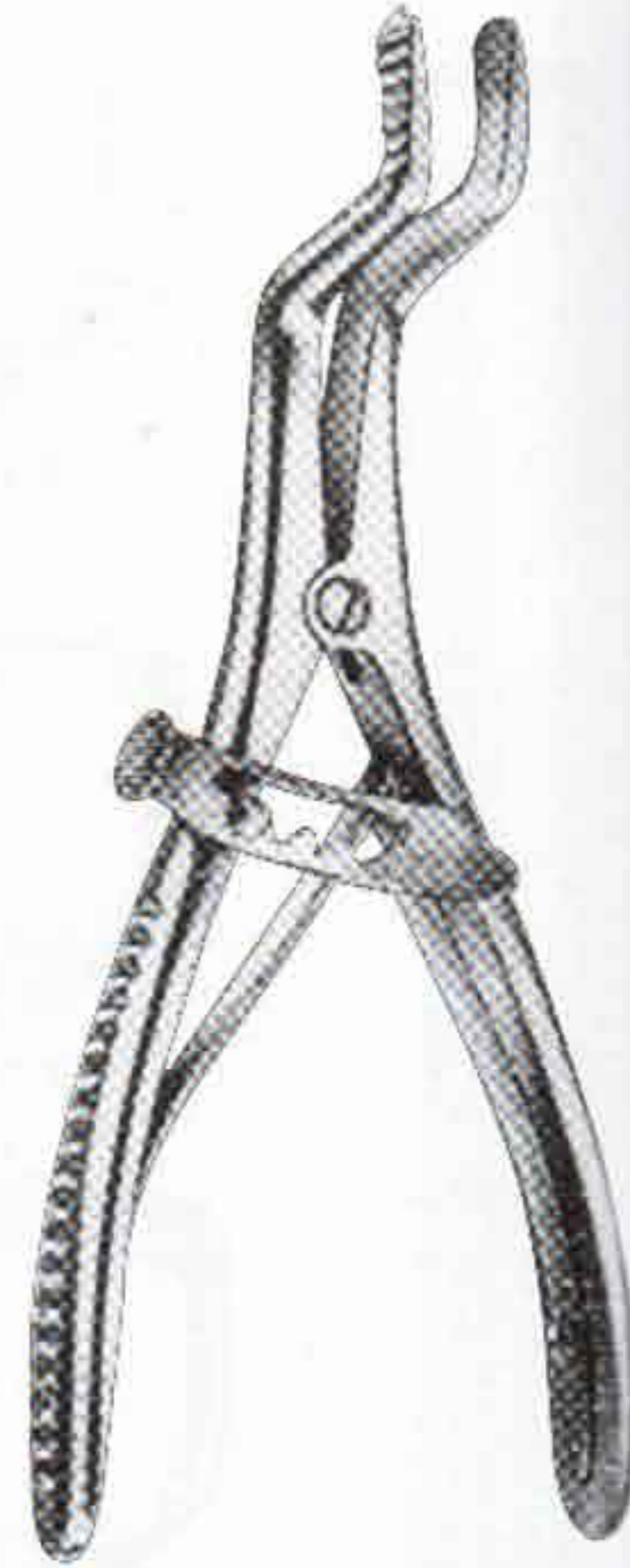

**FERGUSON-ACKLAND**  
12-800  
14.5 cm, 5 3/4"

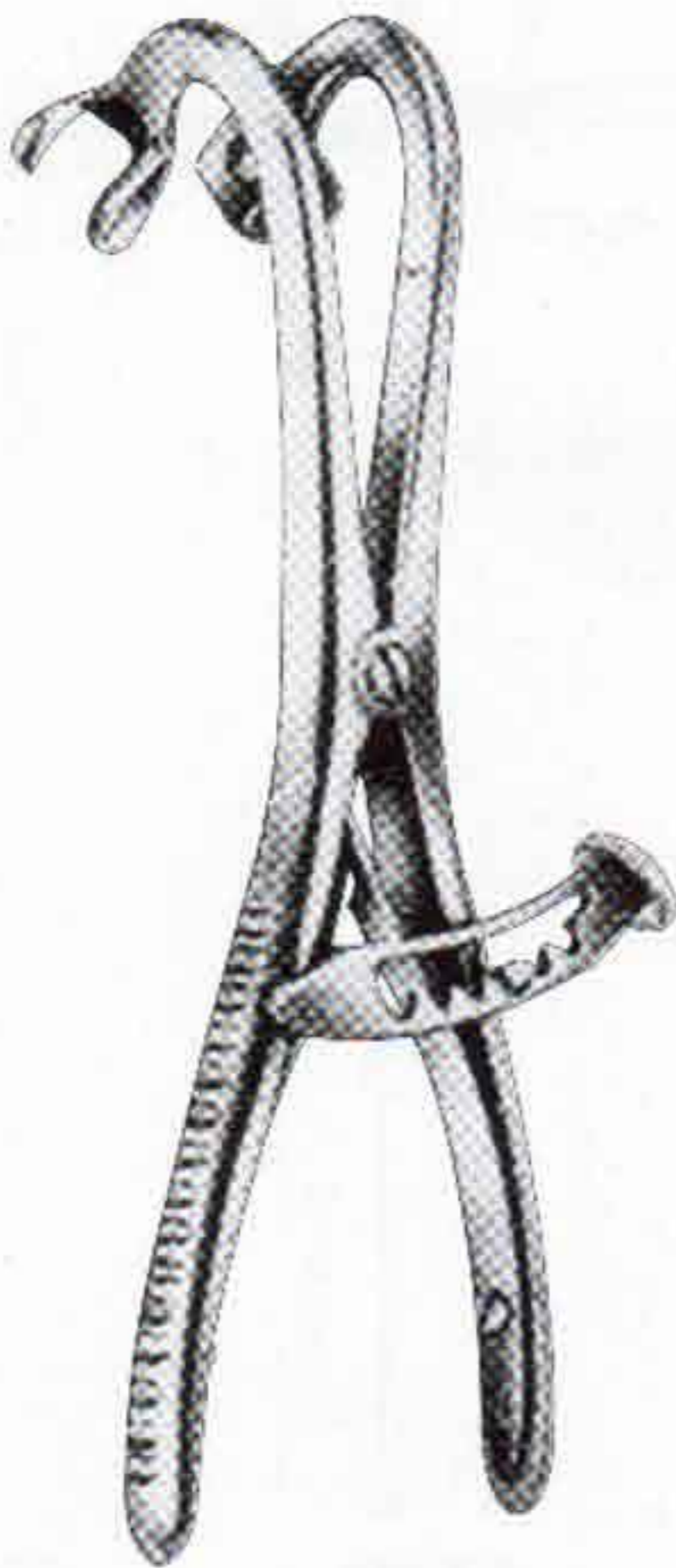

**DENHARDT**  
12-810  
12.5 cm, 5"  
Mouth Gag  
with silicon inserts,  
interchangeable

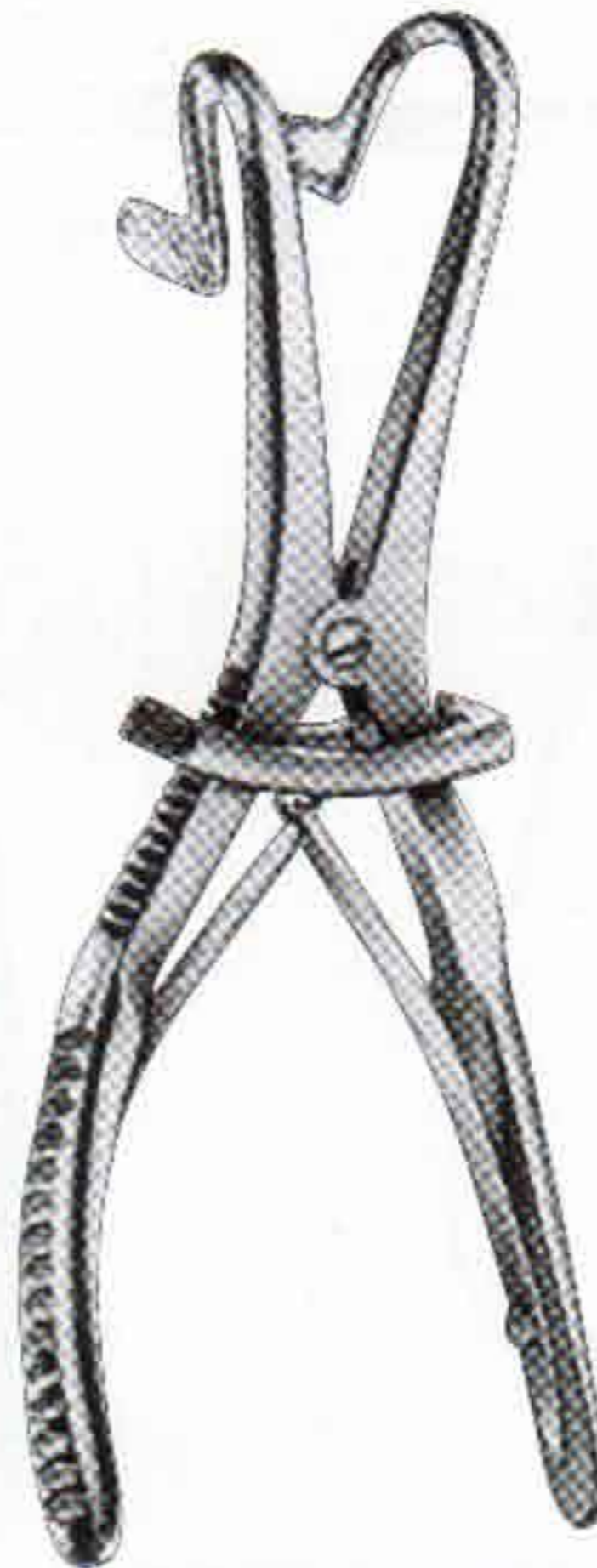

**ROSER-KONIG**  
12-820  
16 cm, 6 1/4"  
Mouth Gag

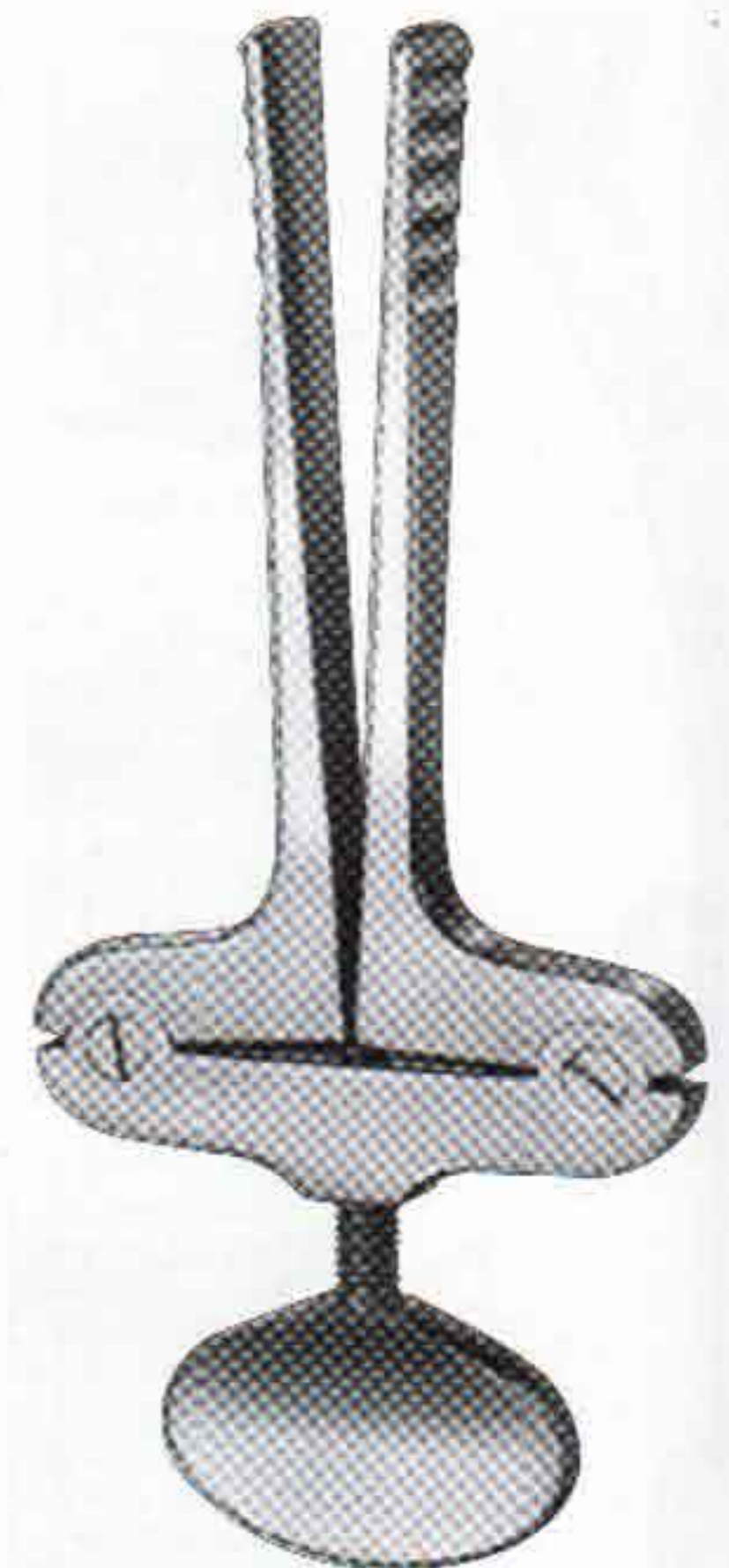

**HEISTER**  
12-830 13 cm, 5"  
Mouth Gag



# MOUTH GAG, LIP & CHEEK RETRACTORS

Mundsperrer, Lippen- u Wangenhalter  
Abrebocas, Separadores Para Labios y Mejillas

Ouvre-bouche, Ecarteurs Des Lèvres et Joues  
Apribocca, Separatori Per Labbra e Guancia



**DAVIS-BOYLE**  
12-840  
Complete Set  
Double Bite-Lift Side  
Gag only left side



12-851

12-852

12-853

12-854



12-850

**DAVIS-BOYLE**  
12-850 20 X 25mm  
12-851 22 X 60mm  
12-852 25 X 75mm  
12-853 25 X 90mm  
12-854 27 X 105mm  
Tongue Blades only.

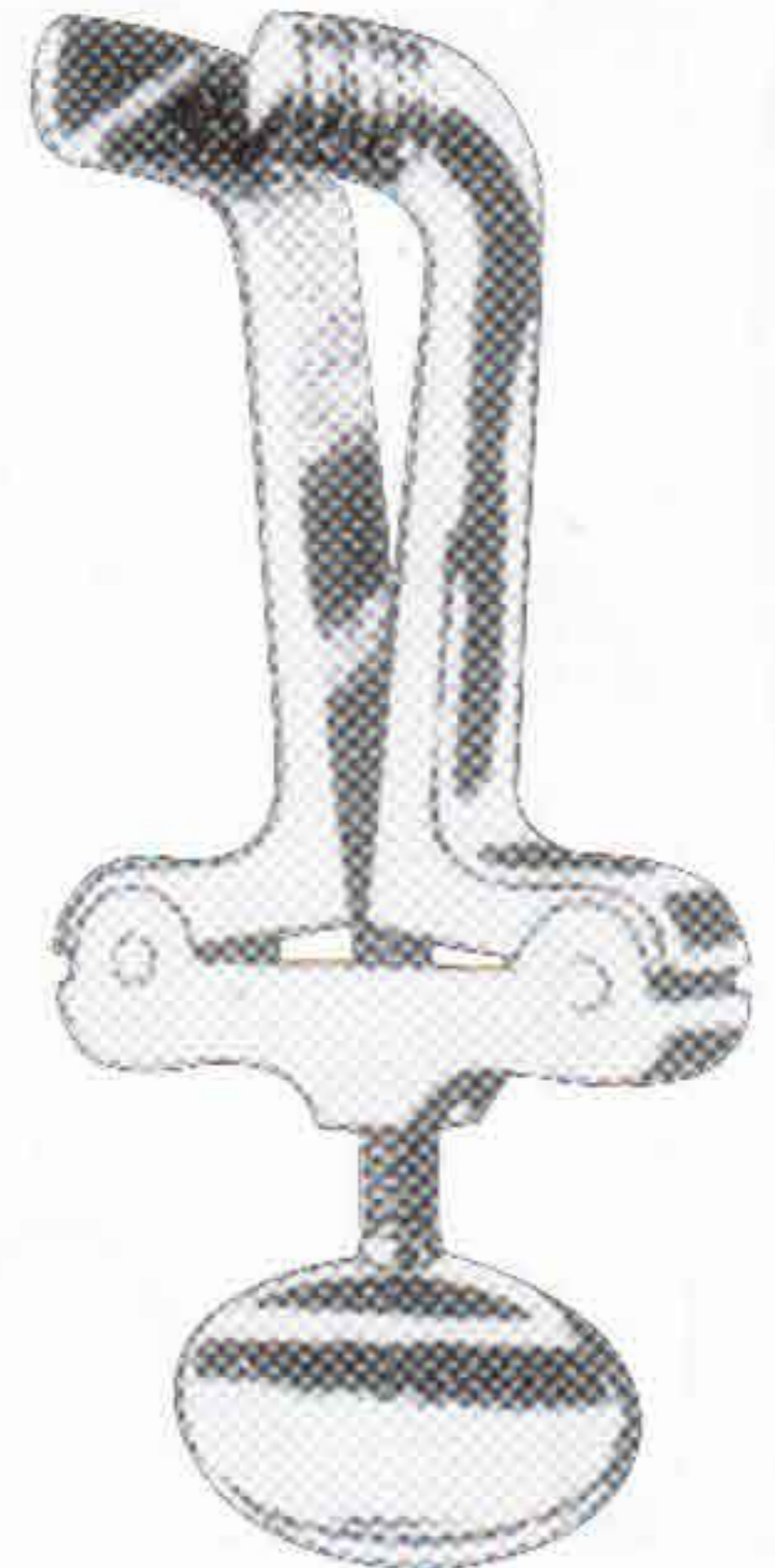

**HEISTER**  
12-860 12 cm, 4.75"  
Mouth Gag



**WHITEHEAD-JENNINGS**  
12-870 9 cm, 3 1/2"  
12-871 11 cm, 4 1/4"  
12-872 13 cm, 5"  
12-873 15 cm, 6"  
Mouth Gag

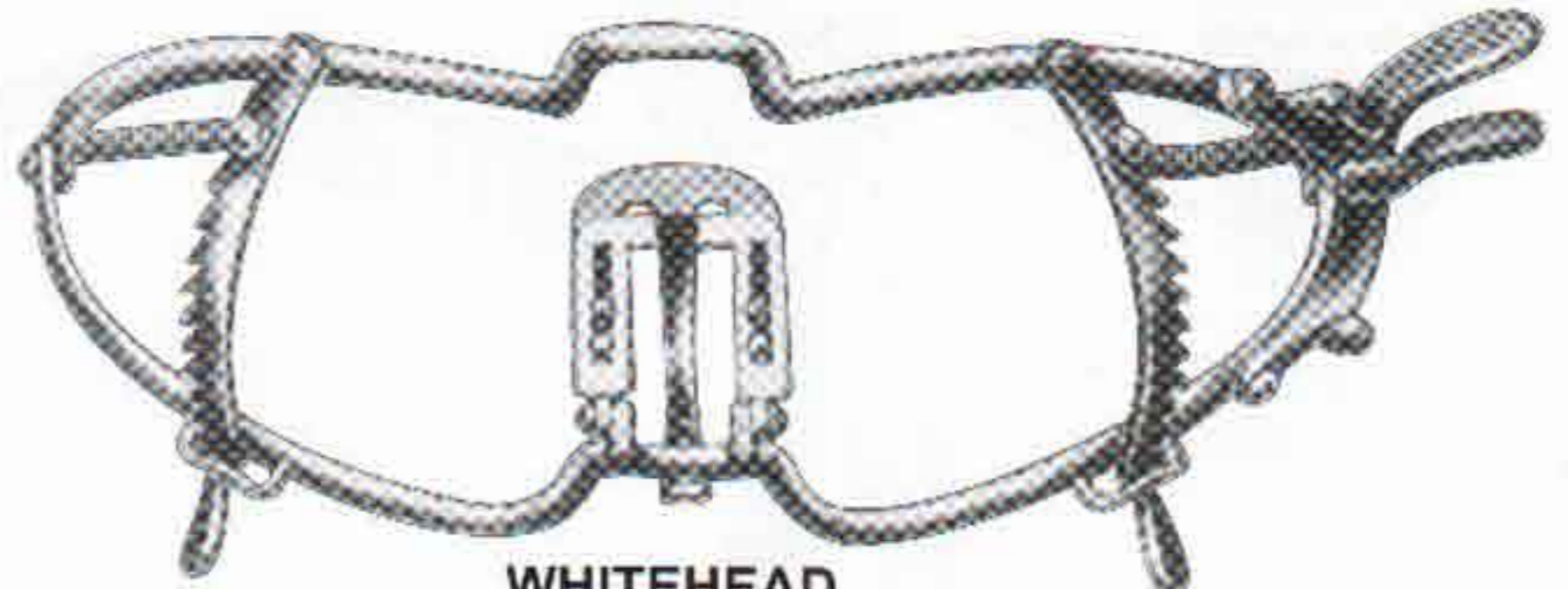

**WHITEHEAD**  
12-880 11 cm, 4 1/4"  
12-881 13 cm, 5"  
12-882 15 cm, 6"  
Mouth Gag  
with tongue depressor

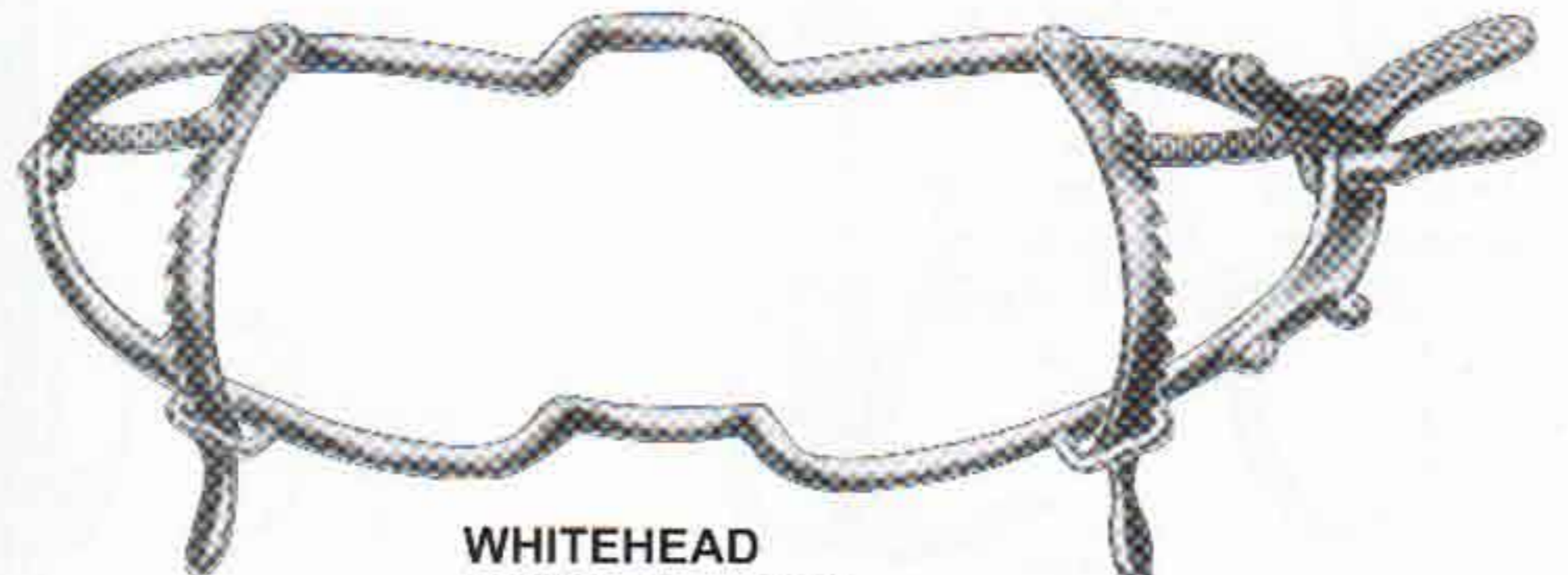

**WHITEHEAD**  
12-890 9 cm, 3 1/2"  
12-891 11 cm, 4 1/4"  
12-892 13 cm, 5"  
12-893 15 cm, 6"  
Mouth Gag



# TONGUE DEPRESSORS

Lippen- u Wangenhalter  
Separadores Para Labios y Mejillas

Ecarteurs Des Lèvres et Joues  
Separatori Per Labbra e Guancia



**BUCHWALD**  
12-900  
Tongue Depressor  
18 cm, 7"



**BRUENINGS**  
12-910  
Tongue Depressor  
19 cm, 7 1/2"



**TONGUE DEPRESSOR**  
12-920  
14.5 cm, 5 3/4"



**TONGUE DEPRESSOR**  
12-930  
14.5 cm, 5 3/4"



**12-940**  
14.5 cm, 5 1/2"  
serrated 28 mm

**12-941**  
14.5 cm, 5 1/2"  
serrated 32 mm

**WEIDER**

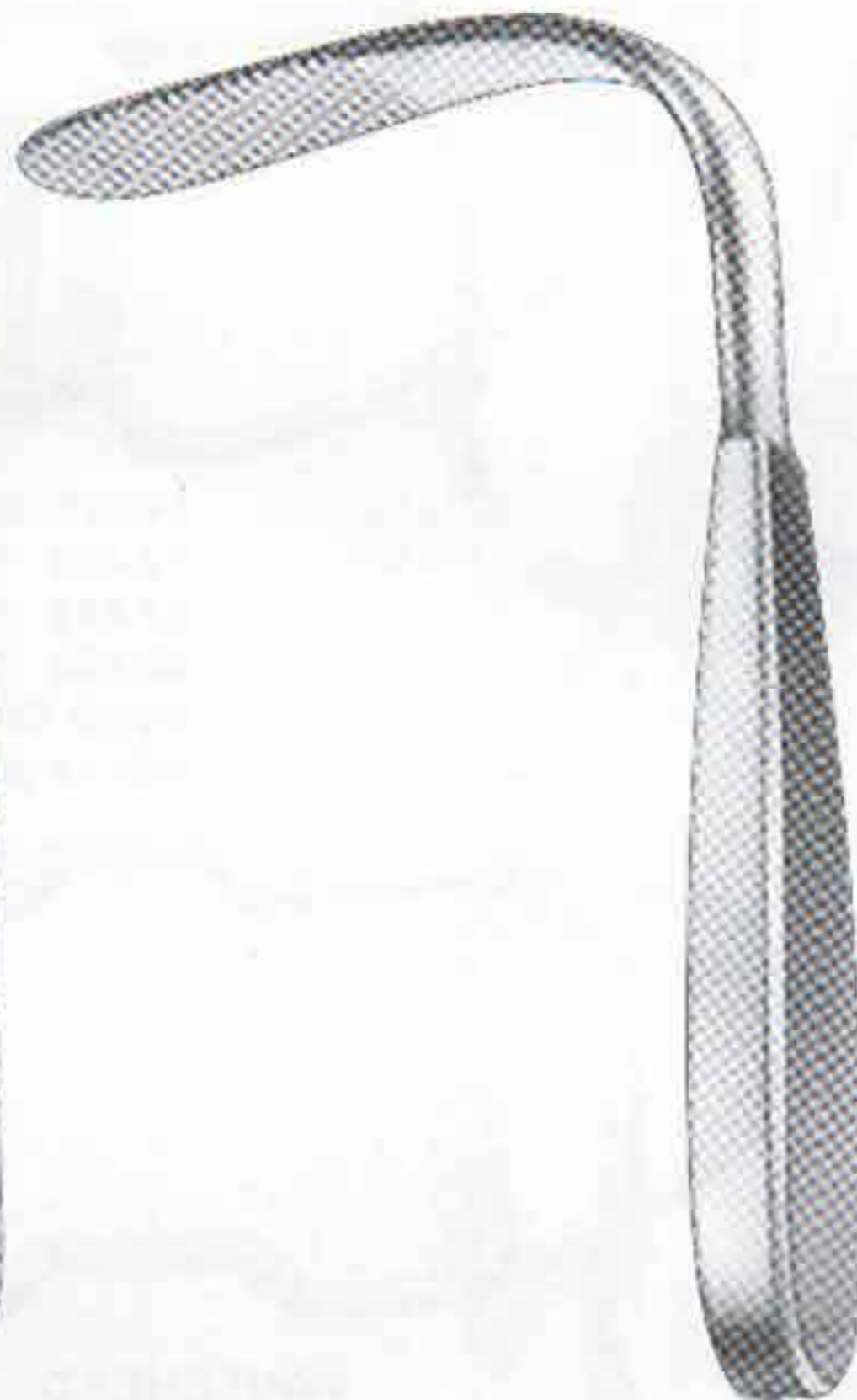

**TOBOLD**  
12-950  
14.5 cm, 5 3/4"



**TONGUE DEPRESSORS**  
12-960



# TONGUE DEPRESSORS

Lippen- u Wangenhalter  
Separadores Para Labios y Mejillas

Ecarteurs Des Lèvres et Joues  
Separatori Per Labbra e Guancia

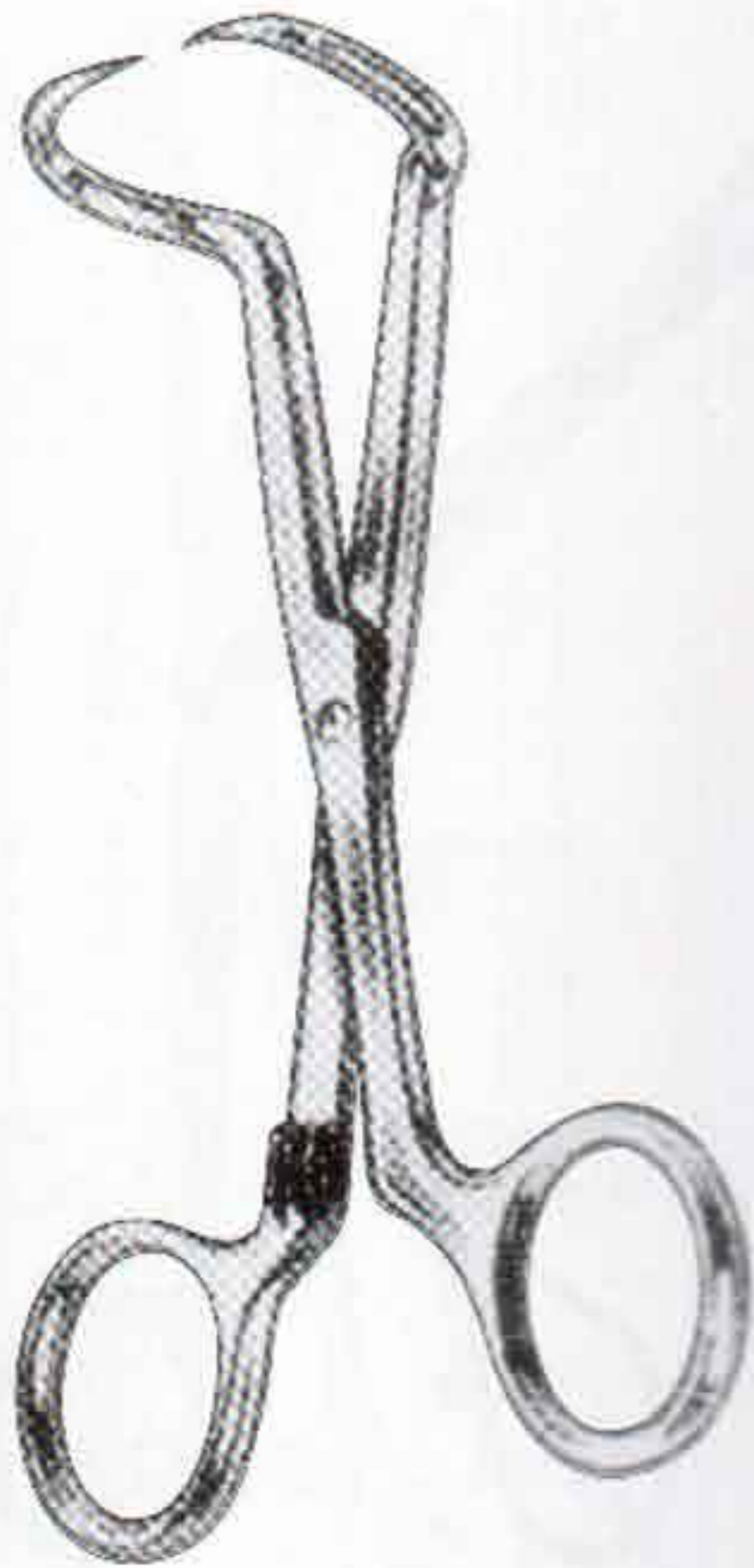

**CARMALT**  
12-970  
12.5 cm, 5"

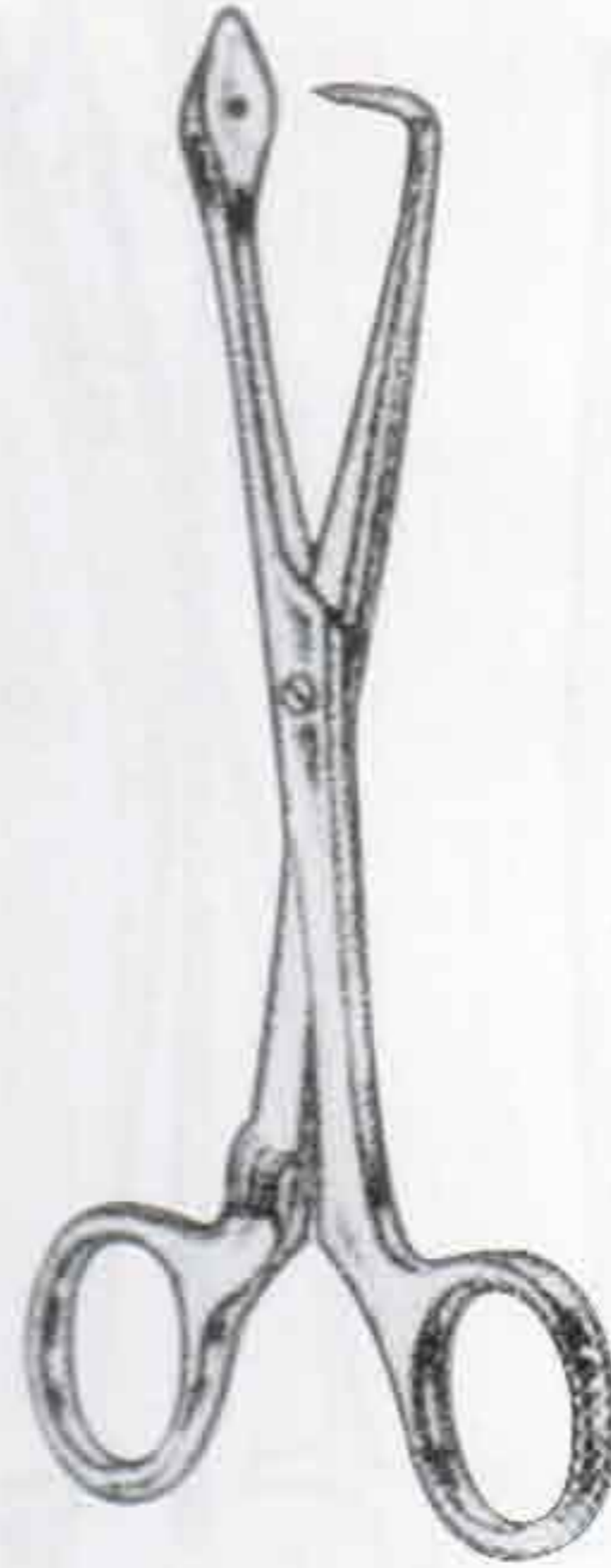

**CARBOULD**  
12-980  
14 cm, 5 1/2"

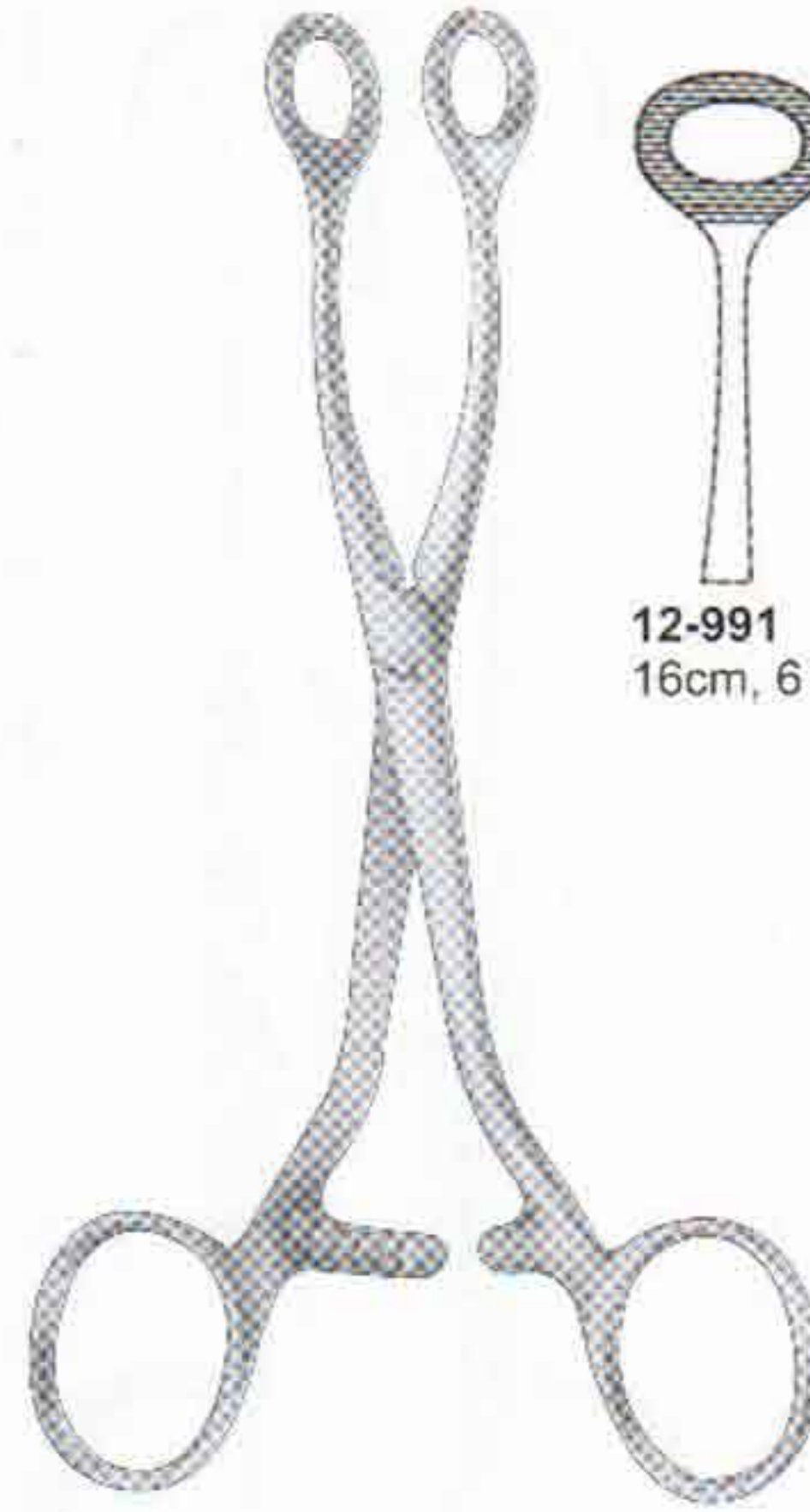

**COLLIN**  
12-990



**12-991**  
16cm, 6 1/4"



**12-992**  
16cm, 6 1/4"



**12-993**  
17cm, 6 3/4"

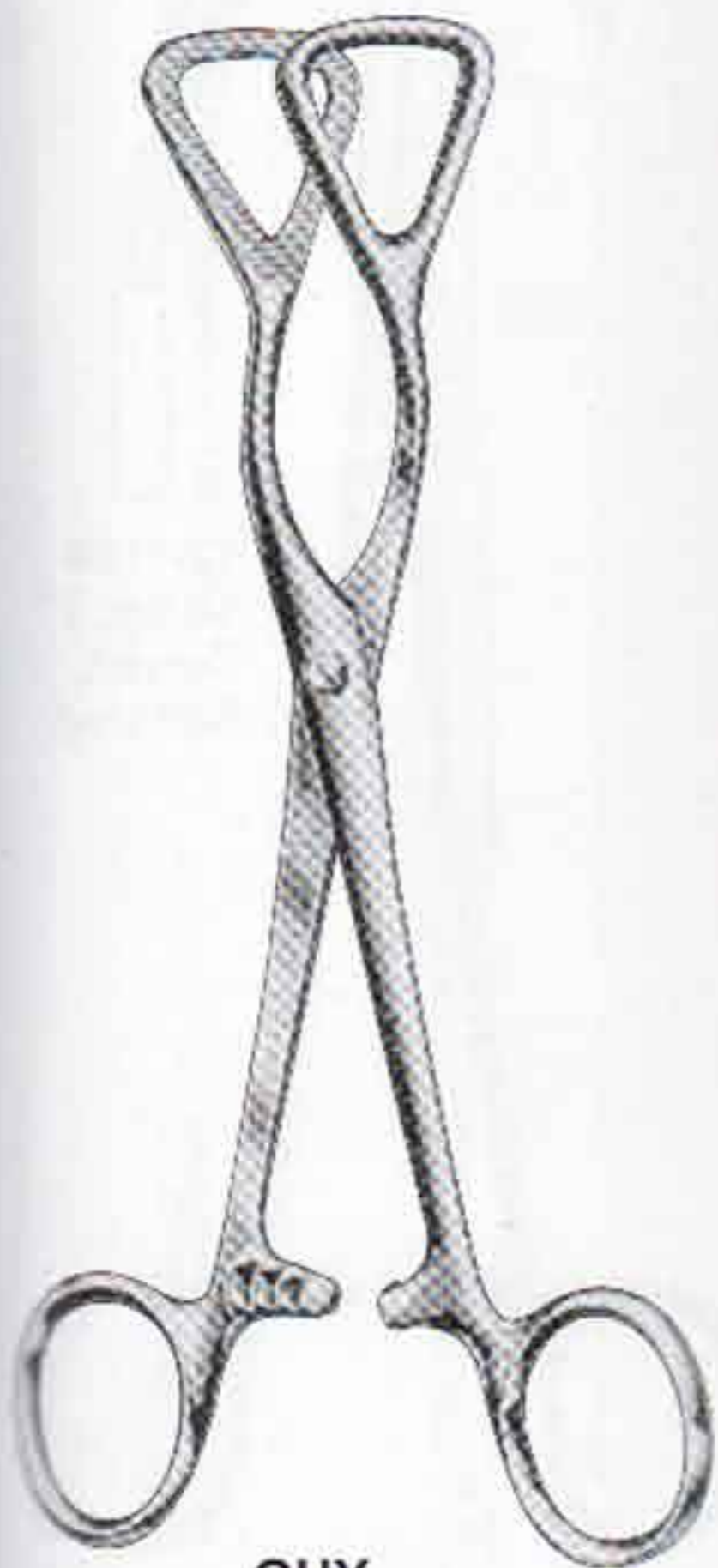

**GUY**  
12-1000  
16 cm, 6"



**MATHIEU**  
12-1010  
19 cm, 7 1/2"

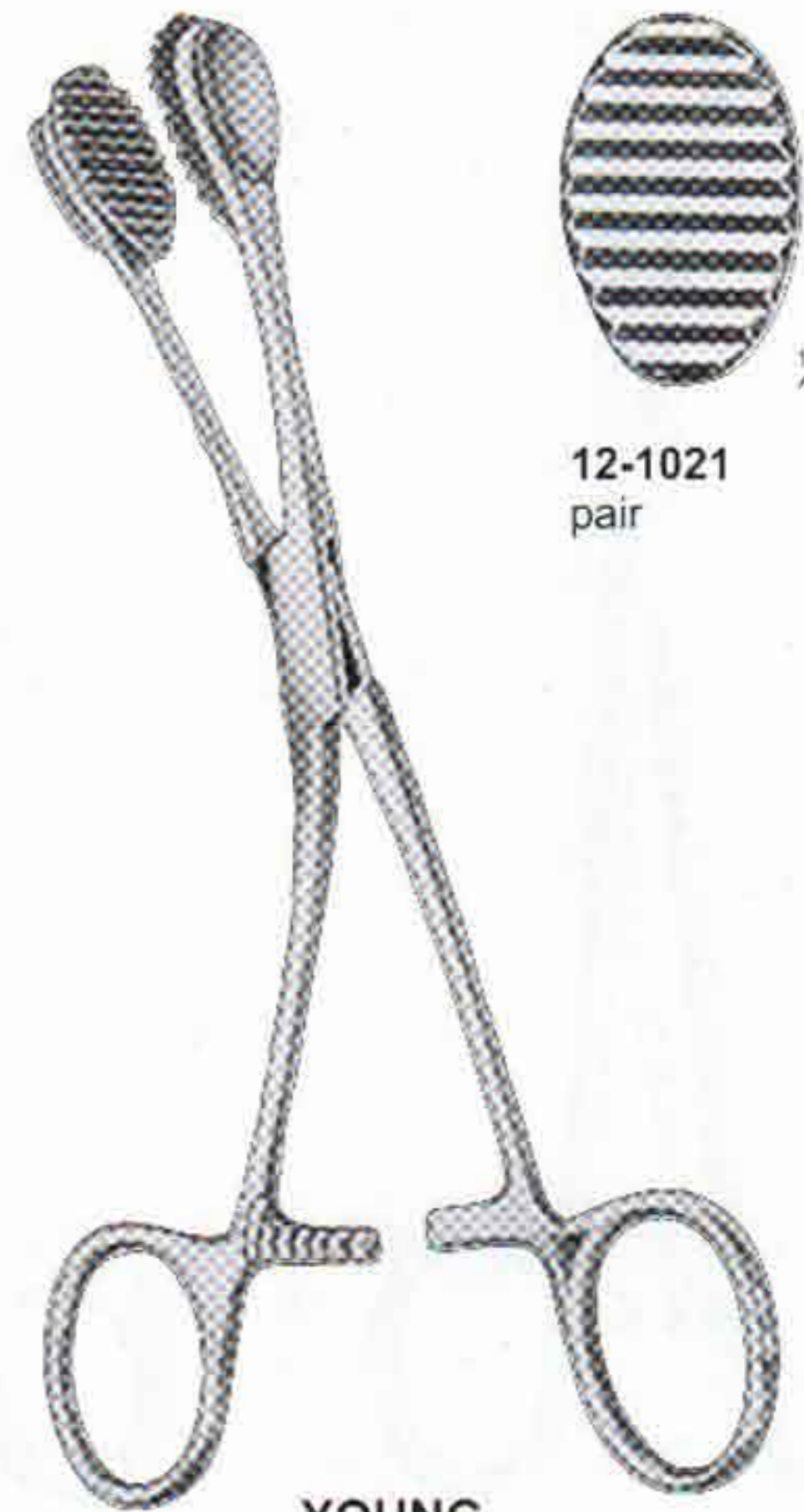

**YOUNG**  
12-1020  
16 cm, 6 1/4"



**12-1021**  
pair



# TONSIL GRASPING FORCEPS, TONSIL FORCEPS

Tonsillenfasszangen, Tonsillenklemmen  
Pinzas Para Amigdalas

Pinces Pour Amygdalas  
Pinze Per Tonsille



**BROPHY**  
12-1030  
19 cm



**LYNCH**  
12-1040  
20 cm



**DUPUY-WEISS**  
12-1050  
22 cm



**HURD**  
12-1060  
22.5 cm



**WEIDER**  
12-1070  
21.5 cm



**TIVNEN TONSIL SEIZING FORCEPS**  
12-1080  
Guard on lock prevents over-riding of 3 x 3 mm  
21.6 cm, 8 1/2"



**WHITE**  
12-1090 18 cm, 7"  
12-1091 23 cm, 9"



**COLVER**  
12-1100  
19 cm

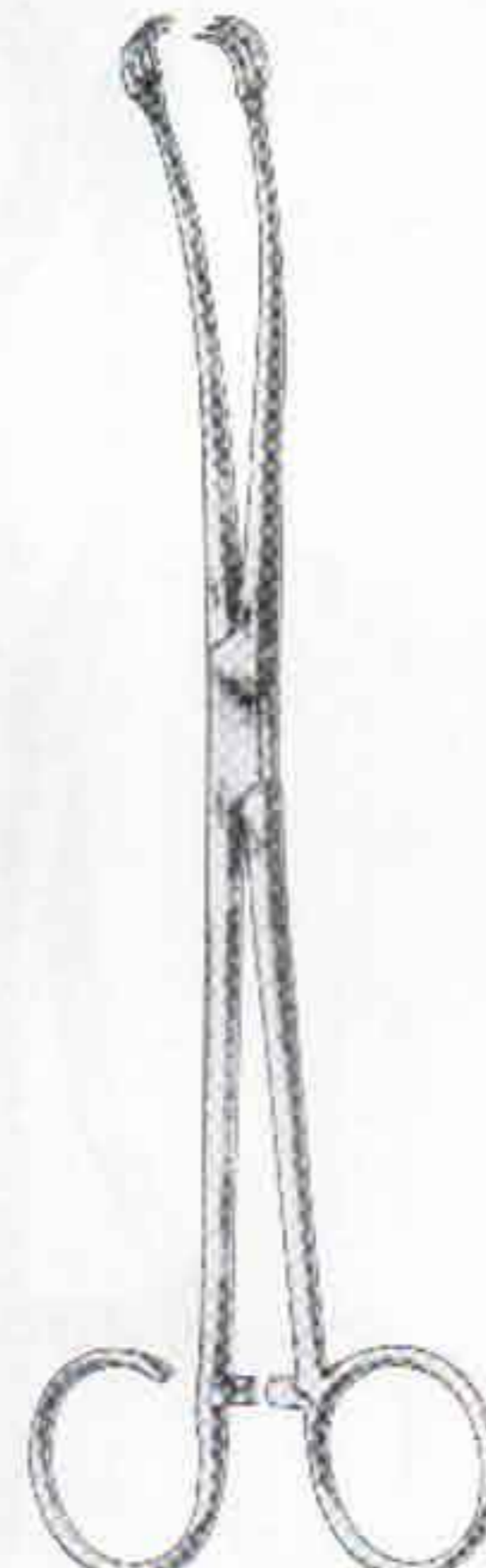

**BALLENGER**  
12-1110  
21.5 cm



**SCHNIDT / SAWTER**



# TONSIL GRASPING FORCEPS, TONSIL FORCEPS

Tonsillenfasszangen, Tonsillenklemmen  
Pinzas Para Amigdalas

Pinces Pour Amygdalas  
Pinze Per Tonsille

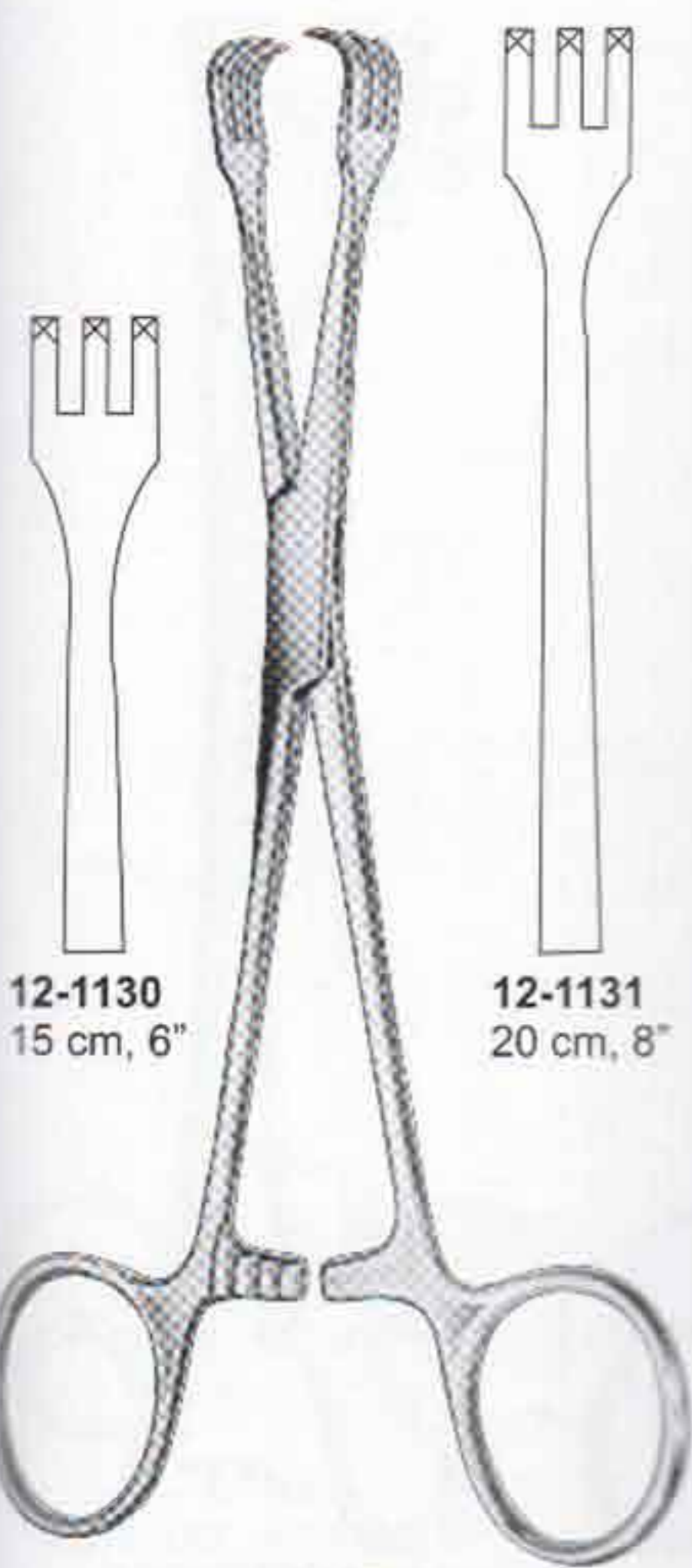

12-1130  
15 cm, 6"



12-1131  
20 cm, 8"

LAHEY



Mastin  
12-1140  
17cm 6 3/4"

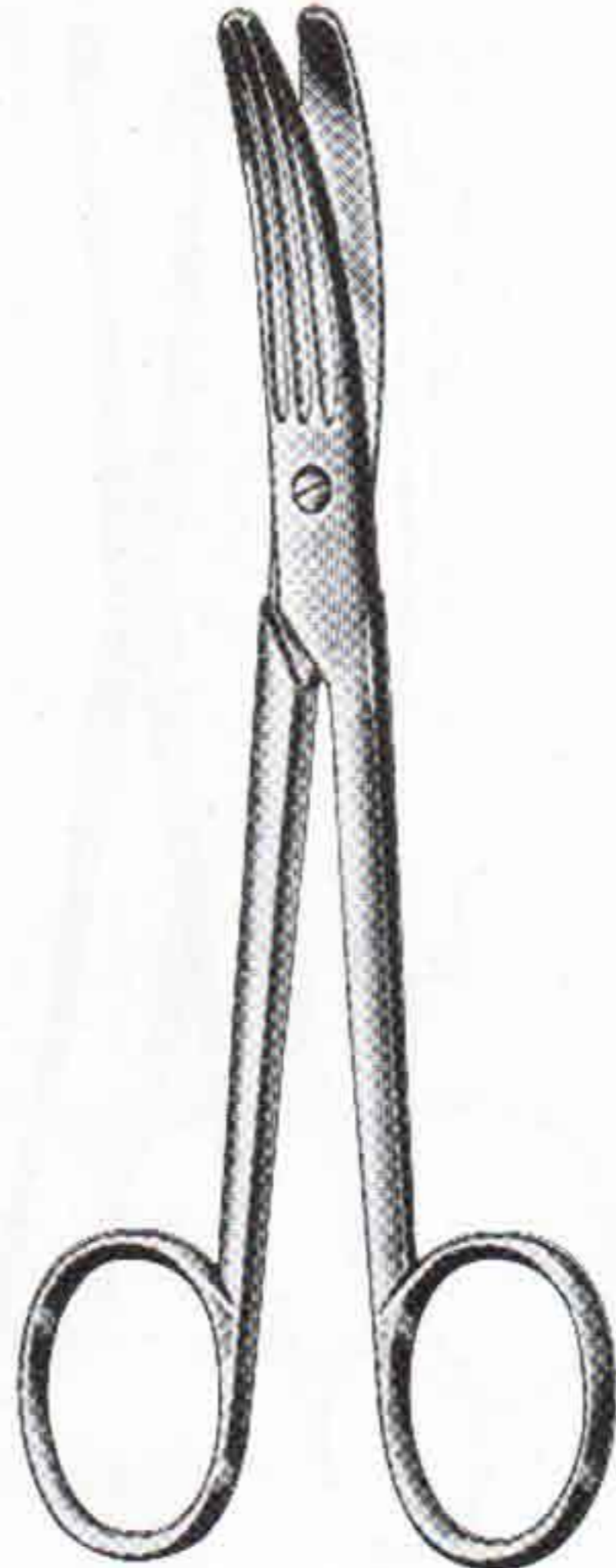

Schoemaker  
12-1150  
15cm 6"



Kocher  
12-1160  
15cm 6"  
12-1161  
16cm 6 1/4"



Kocher  
12-1170

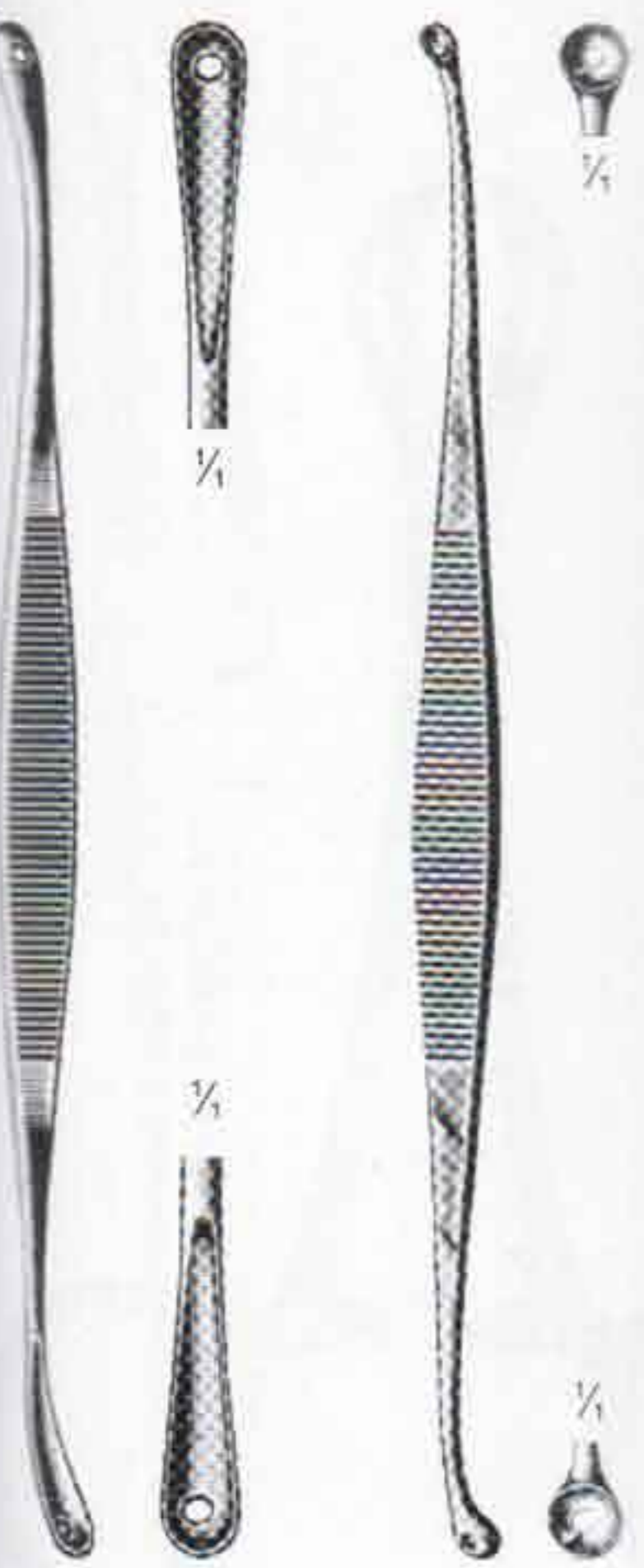

Unna  
12-1180  
14cm 5 1/2"

Unna  
12-1190  
14cm 5 1/2"

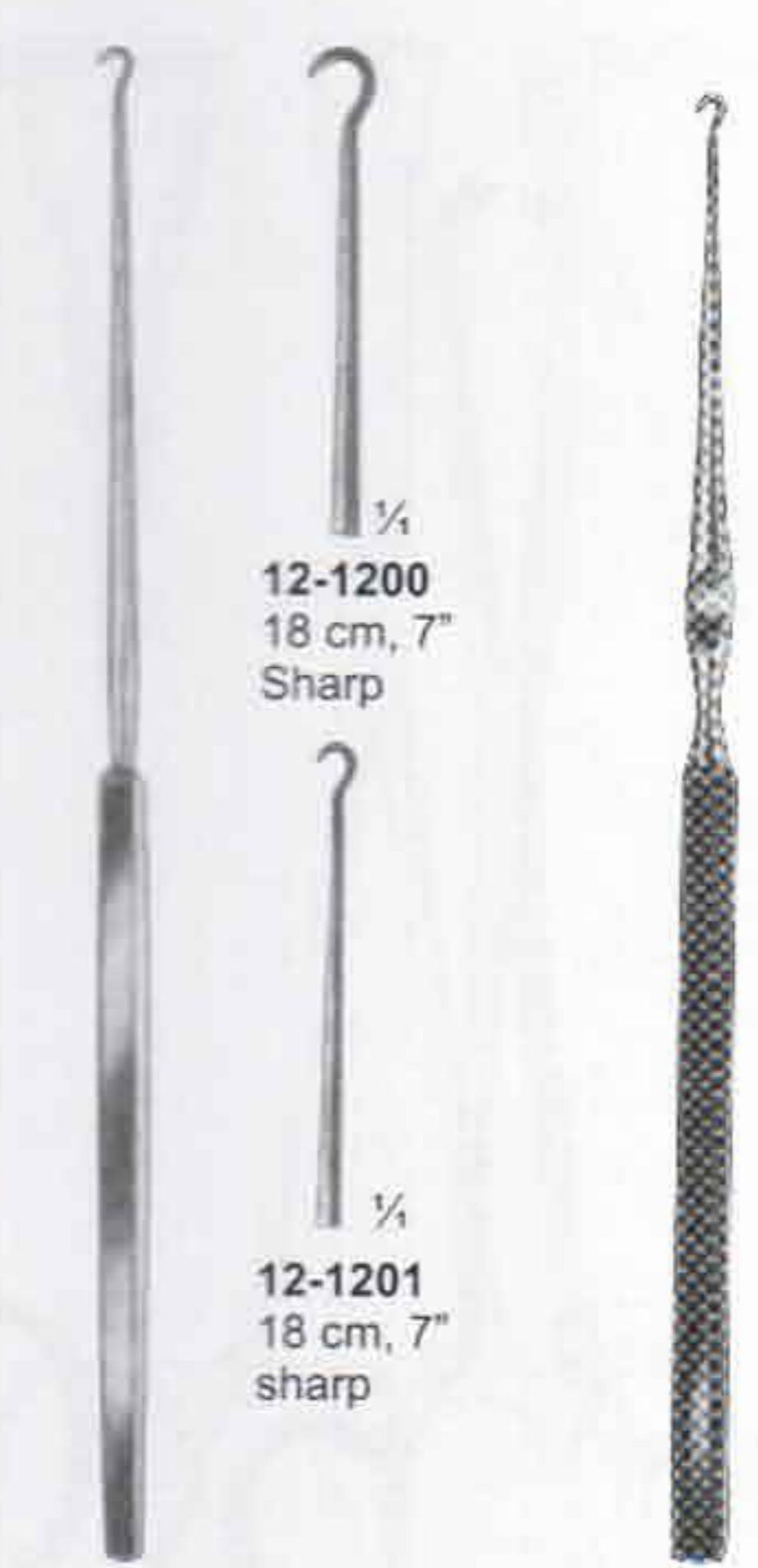

GILLIES

12-1200  
18 cm, 7"  
Sharp

12-1201  
18 cm, 7"  
sharp



KILNER

12-1210  
15 cm, 6"  
blunt

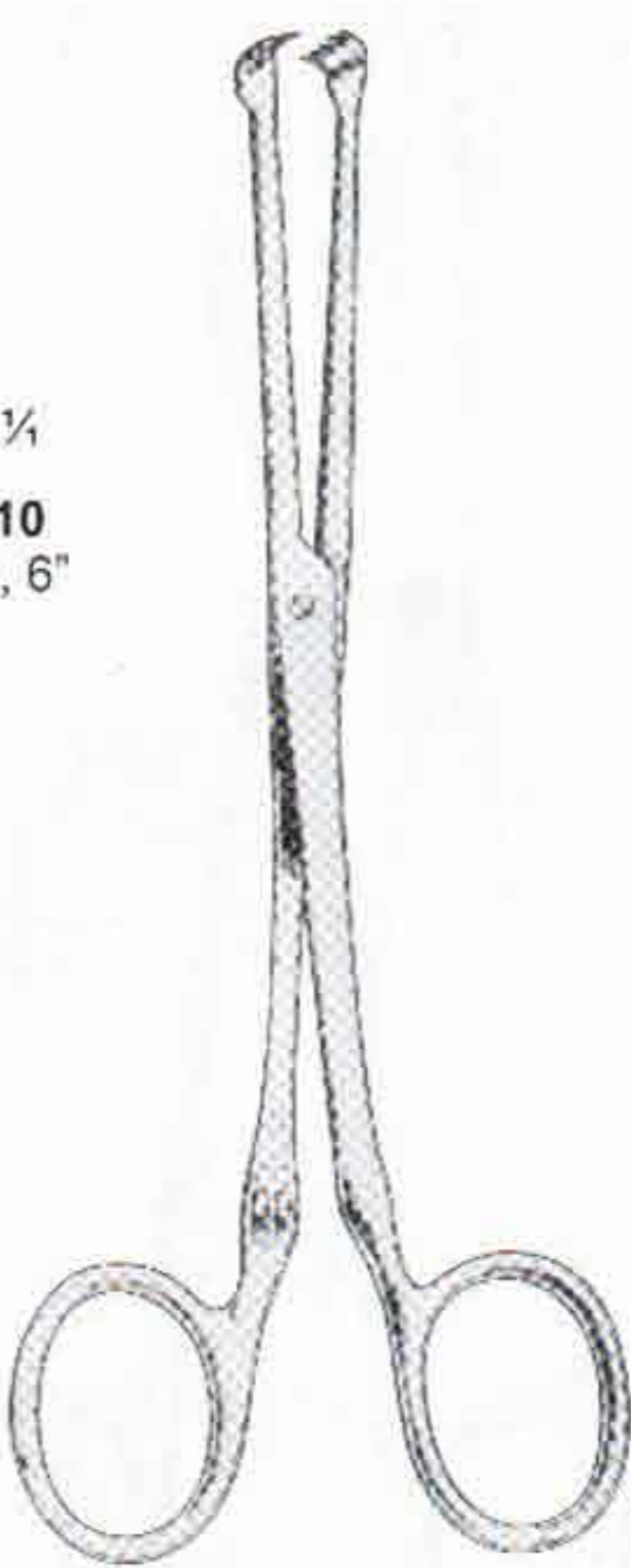

Allis  
12-1220 15cm  
4:5



Allis  
12-1230 15cm 6"  
12-1231 19cm 7 1/2"  
12-1232 25cm 10"



# INTESTINAL & TISSUE GRASPING FORCEPS

Darm-und Gewebefasszangen  
Pinzas Para Intestinos y Tejidos

Pinces Pour Saisir Intestins et Tissus  
Pinze Per Afferrare Intestino e Tessuti

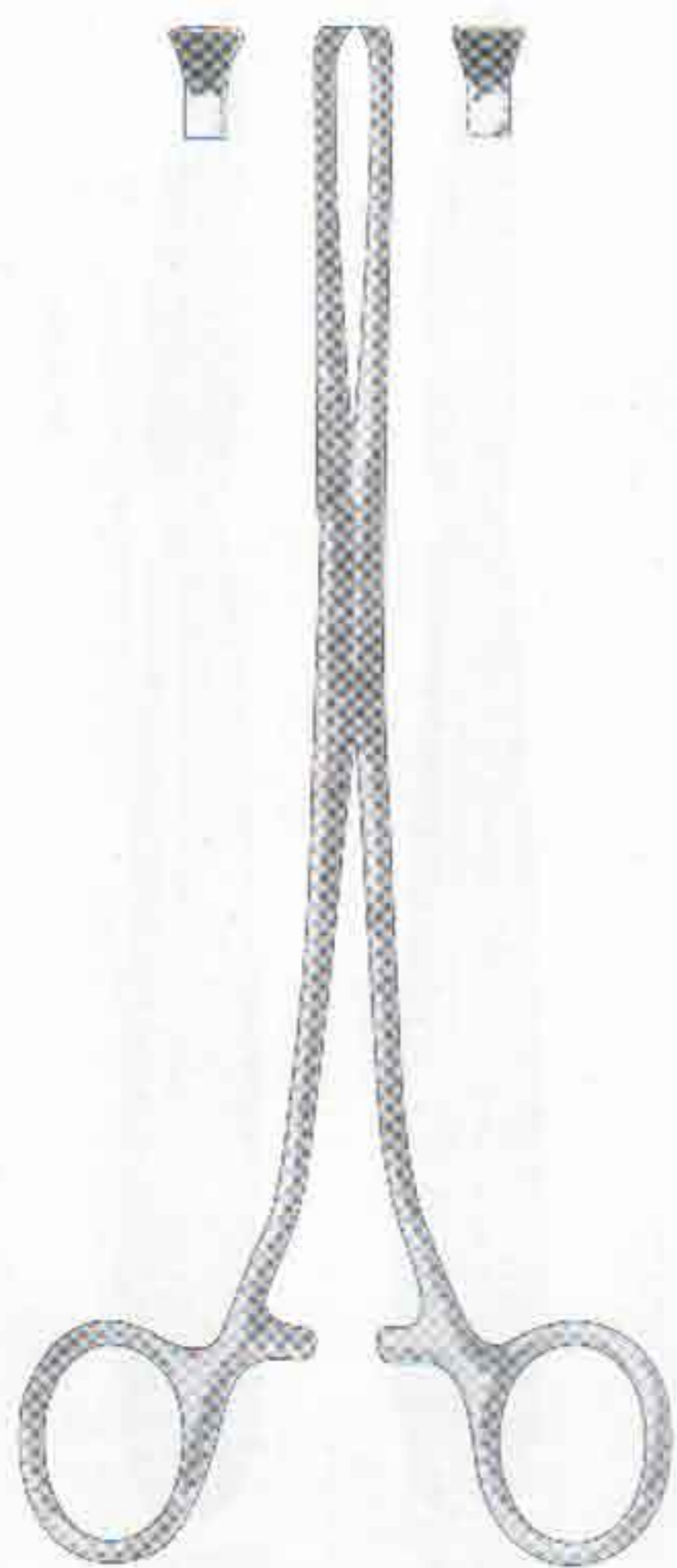

**ALLIS**  
13-100  
20.0 cm, 8"

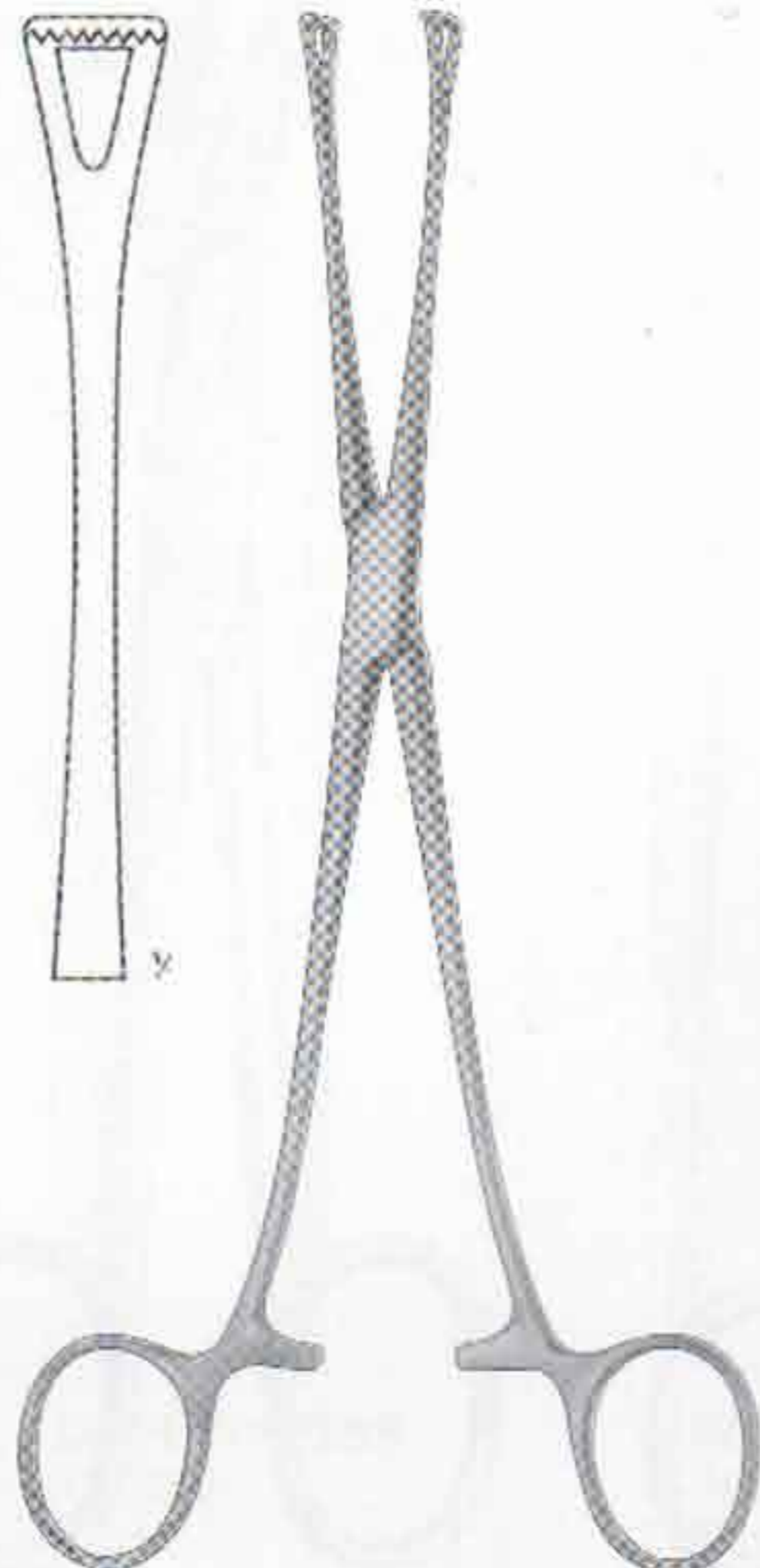

**LOCKWOOD**  
13-110  
20.0 cm, 8"



**ALLIS ADAIR**  
13-120 15.5 cm



**LOCKWOOD**  
13-130  
20cm 8"

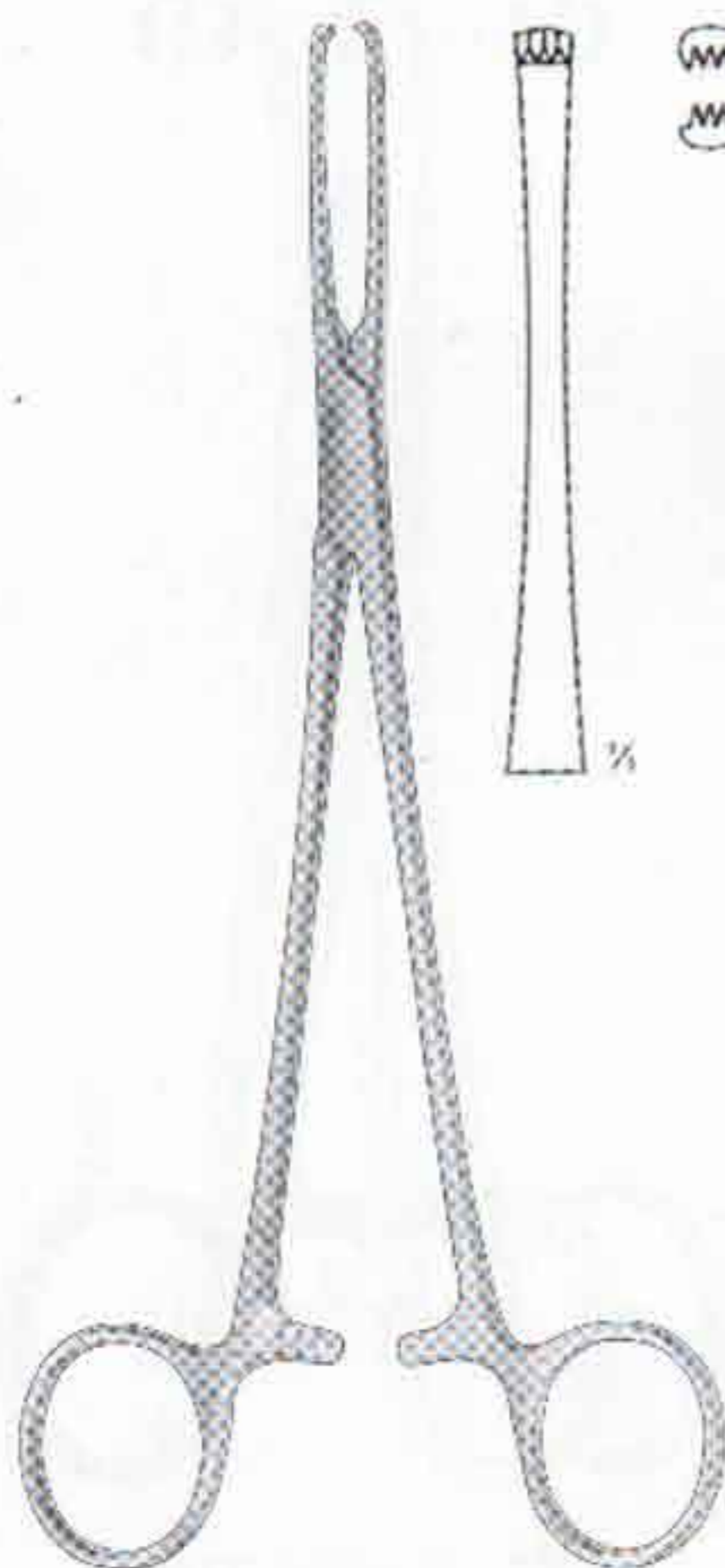

**JUDD-ALLIS**  
13-140  
3 x 4 teeth  
19.5 cm, 7 3/4"



**LITTLEWOOD**  
13-150  
19 cm, 7 1/2"

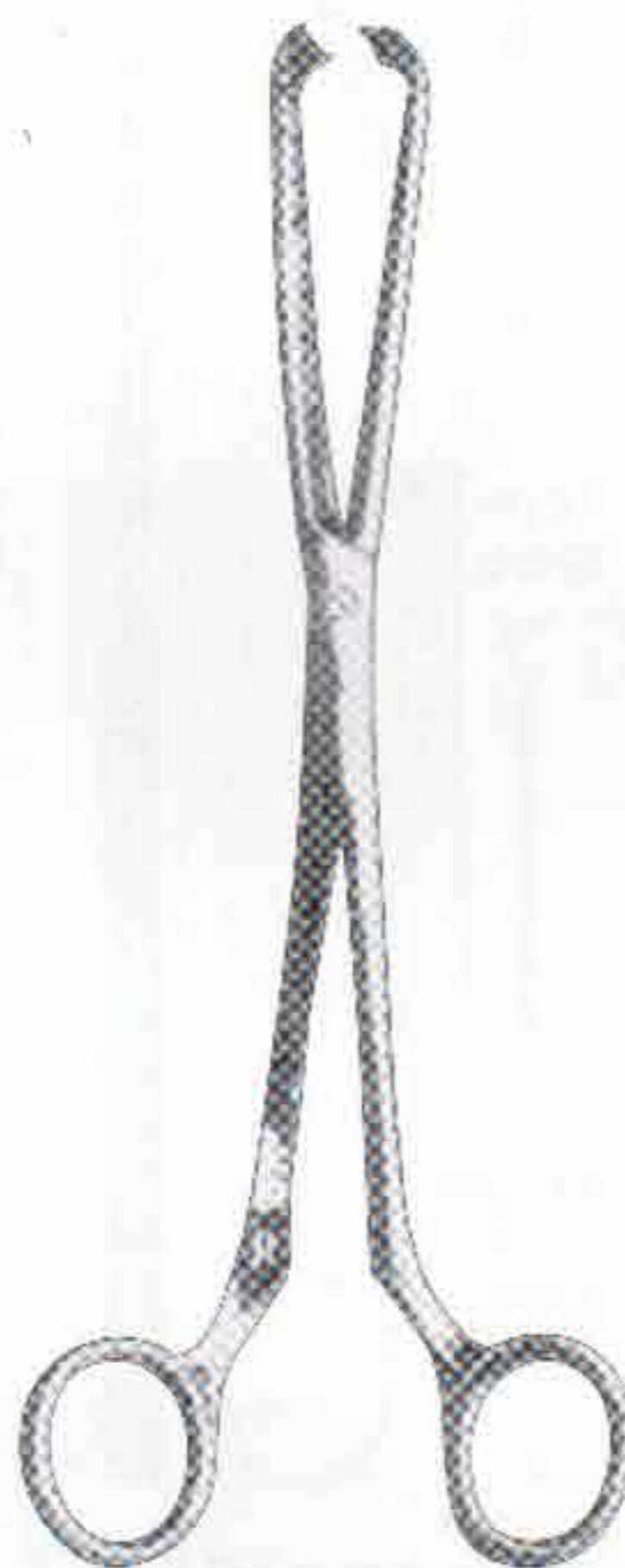

**STILLE**  
13-160  
20 cm, 8"



**LANE**  
13-170 12.5 cm  
13-171 15.0 cm  
13-172 19.0 cm



# INTESTINAL & TISSUE GRASPING FORCEPS

Darm-und Gewebefasszangen  
Pinzas Para Intestinos y Tejidos

Pinces Pour Saisir Intestins et Tissus  
Pinze Per Afferrare Intestino e Tessuti



**LANE**  
13-180 12.7 cm, 5"  
13-181 15 cm, 6"  
13-182 19 cm, 7 1/2"

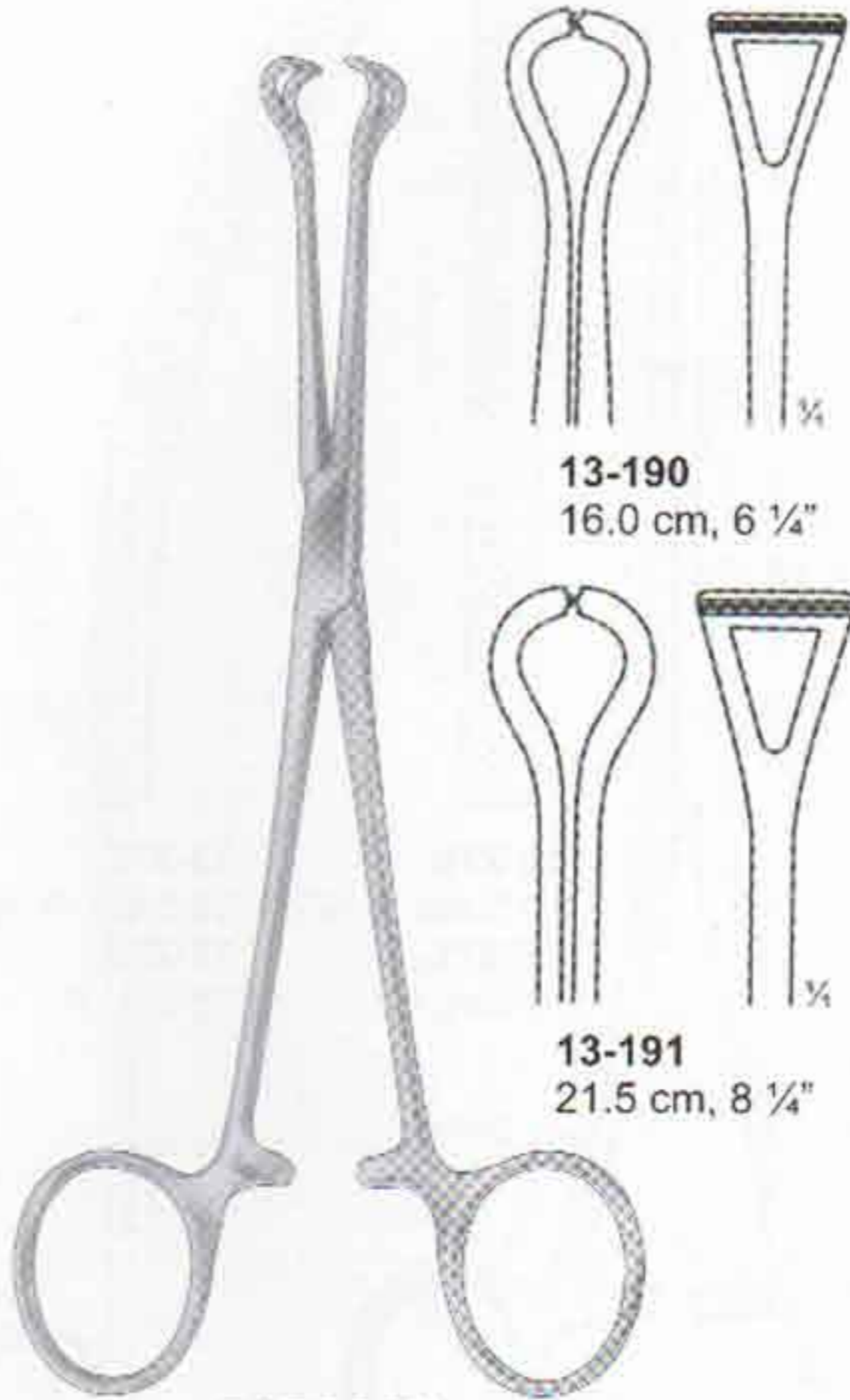

**13-190**  
16.0 cm, 6 1/4"

**13-191**  
21.5 cm, 8 1/4"

**BABCOCK**

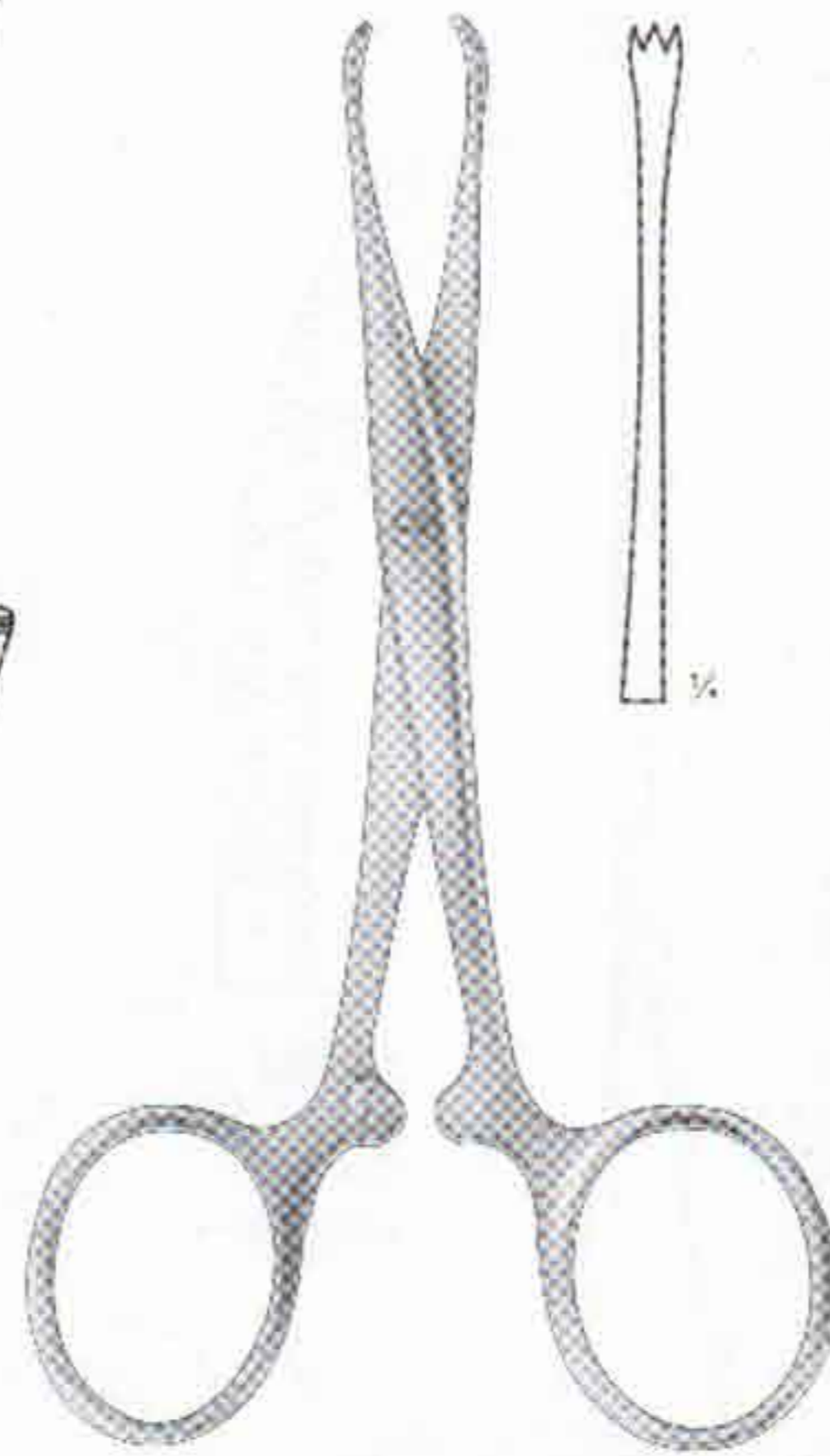

**CHAPUT**  
13-200  
2 x 3 teeth, sharp  
12.5 cm, 5"

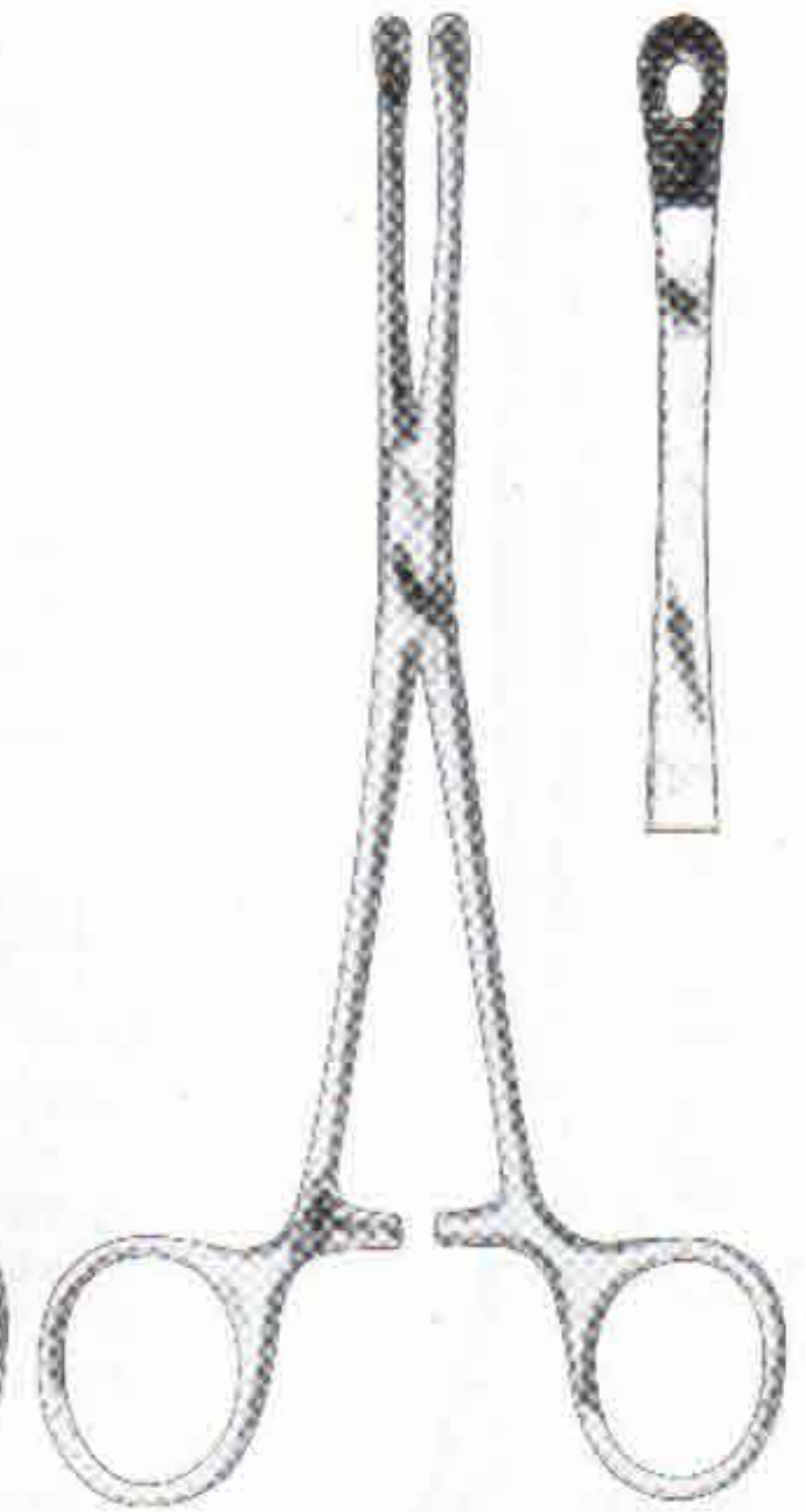

**PERCY**  
13-210  
24.0 cm, 9 1/4"



**DENNIS-BROWN**  
13-220  
18.0 cm, 7"



**DUVAL**  
13-230 18cm 7"  
13-231 20cm 8"

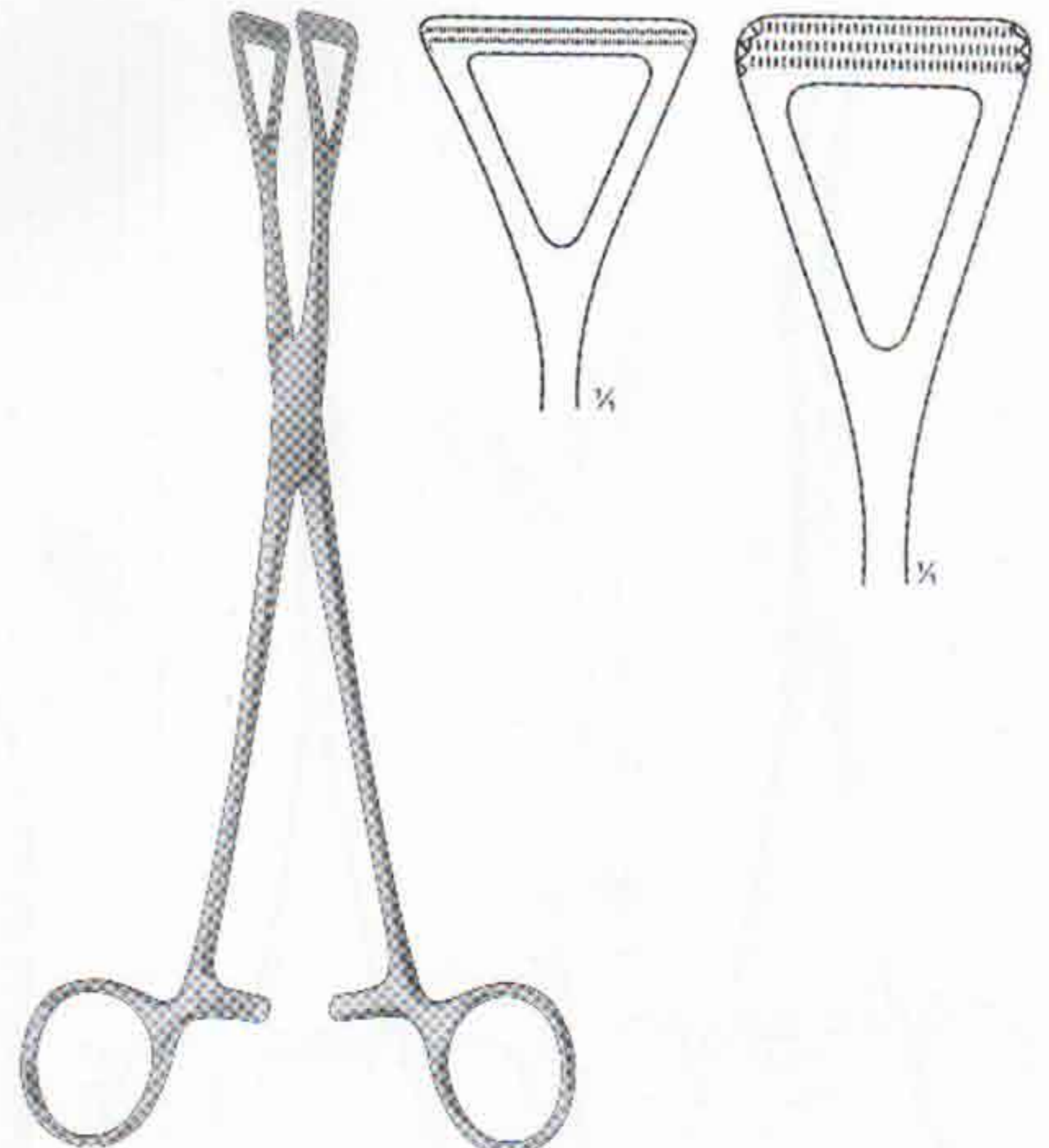

**COLLIN**  
13-240  
23.0 cm, 9"



# INTESTINAL & TISSUE GRASPING FORCEPS

Darm-und Gewebefasszangen  
Pinzas Para Intestinos y Tejidos

Pinces Pour Saisir Intestins et Tissus  
Pinze Per Afferrare Intestino e Tessuti

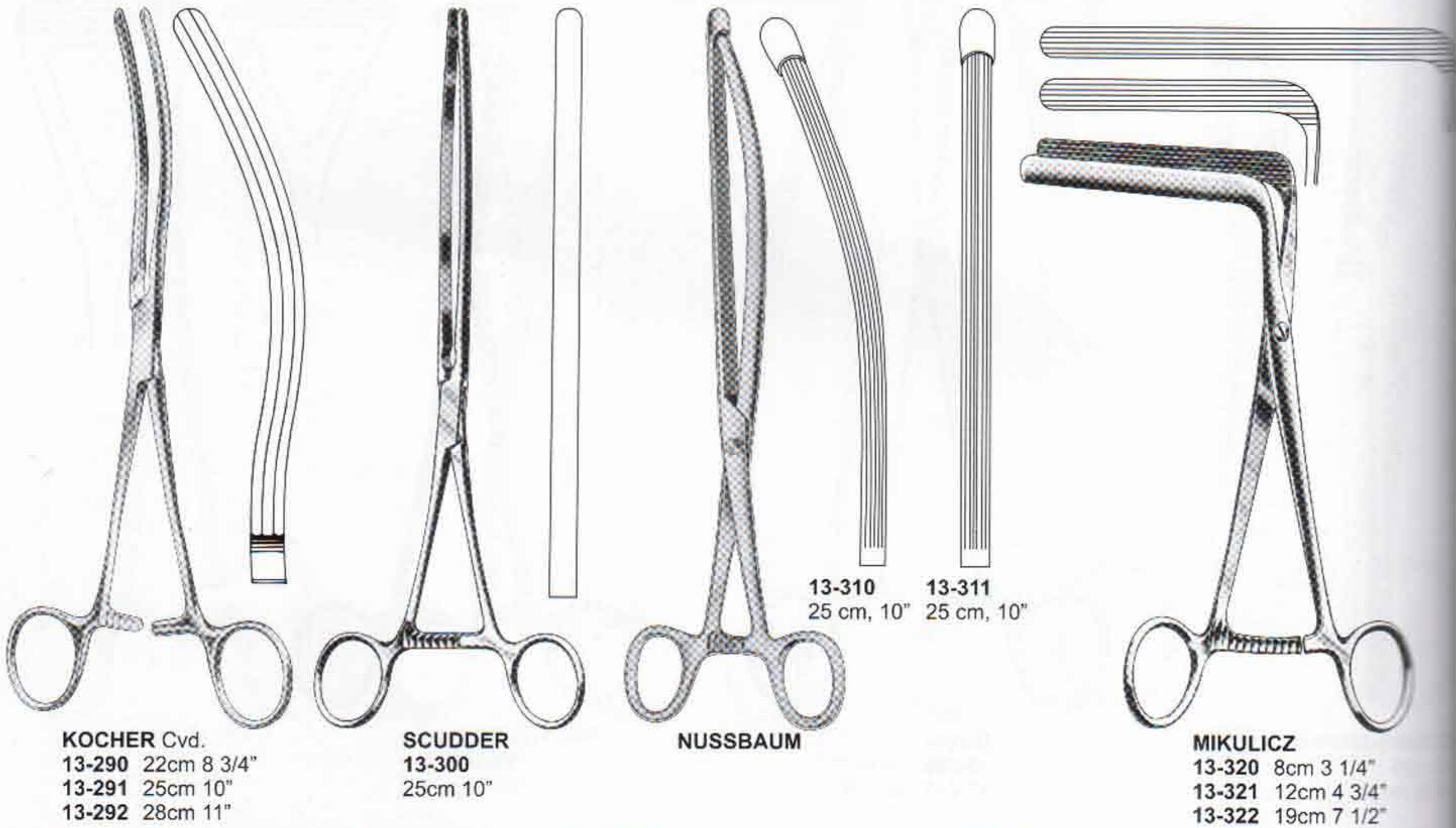
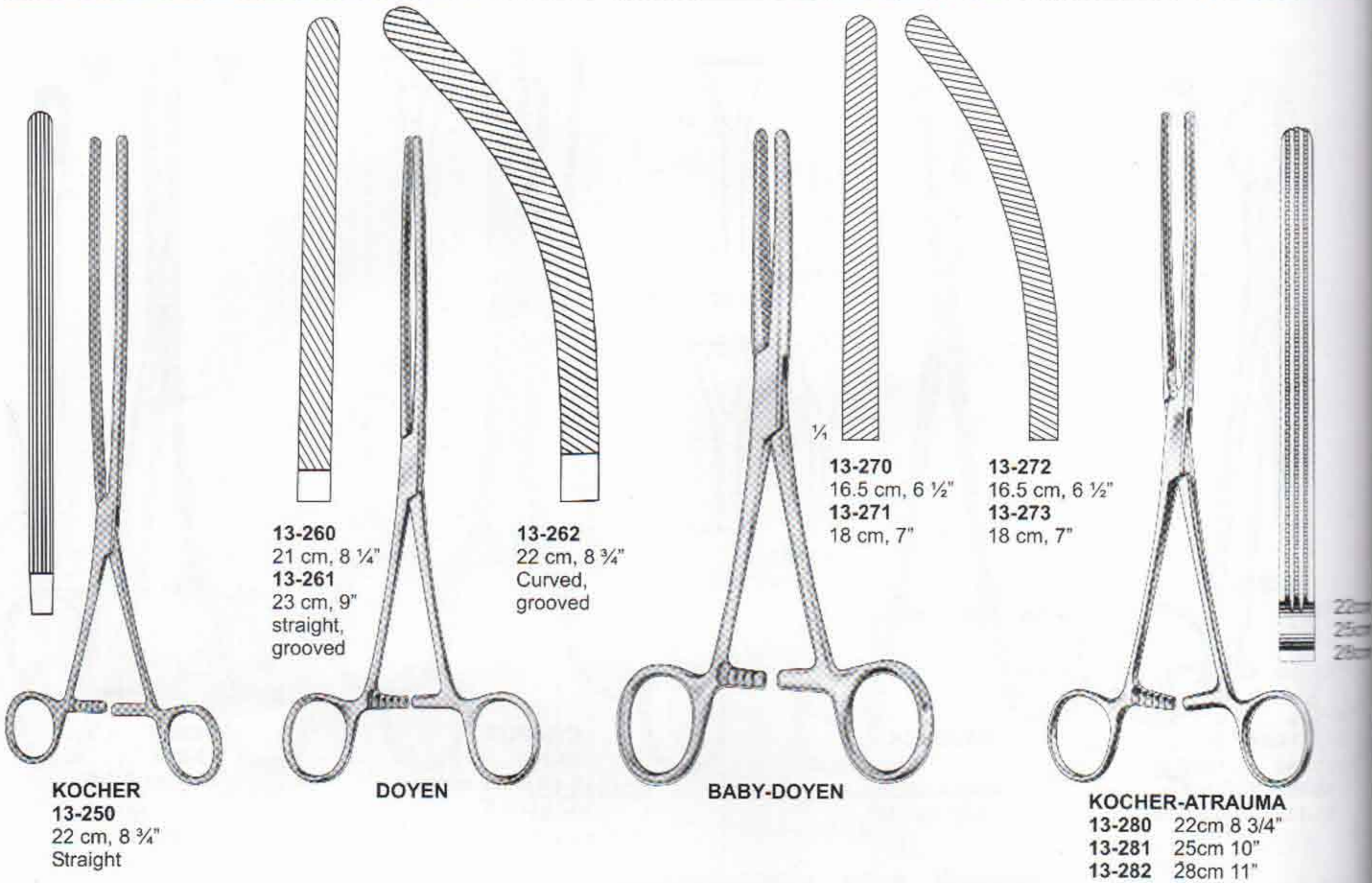



# INTESTINAL & TISSUE GRASPING FORCEPS

Darm-und Gewebefasszangen  
Pinzas Para Intestinos y Tejidos

Pinces Pour Saisir Intestins et Tissus  
Pinze Per Afferrare Intestino e Tessuti

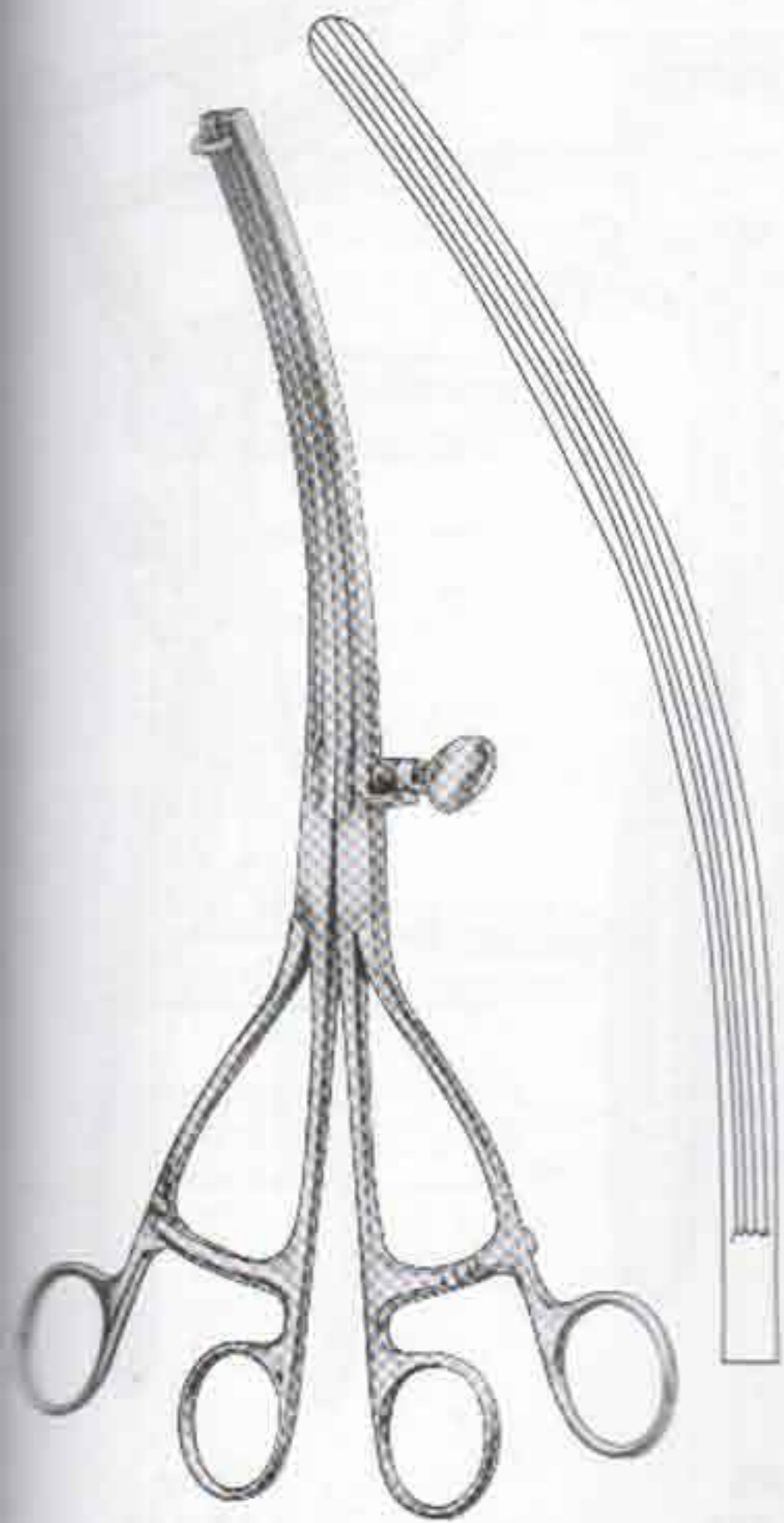

**LANE Cvd.**  
**13-330**  
30 cm, 12"

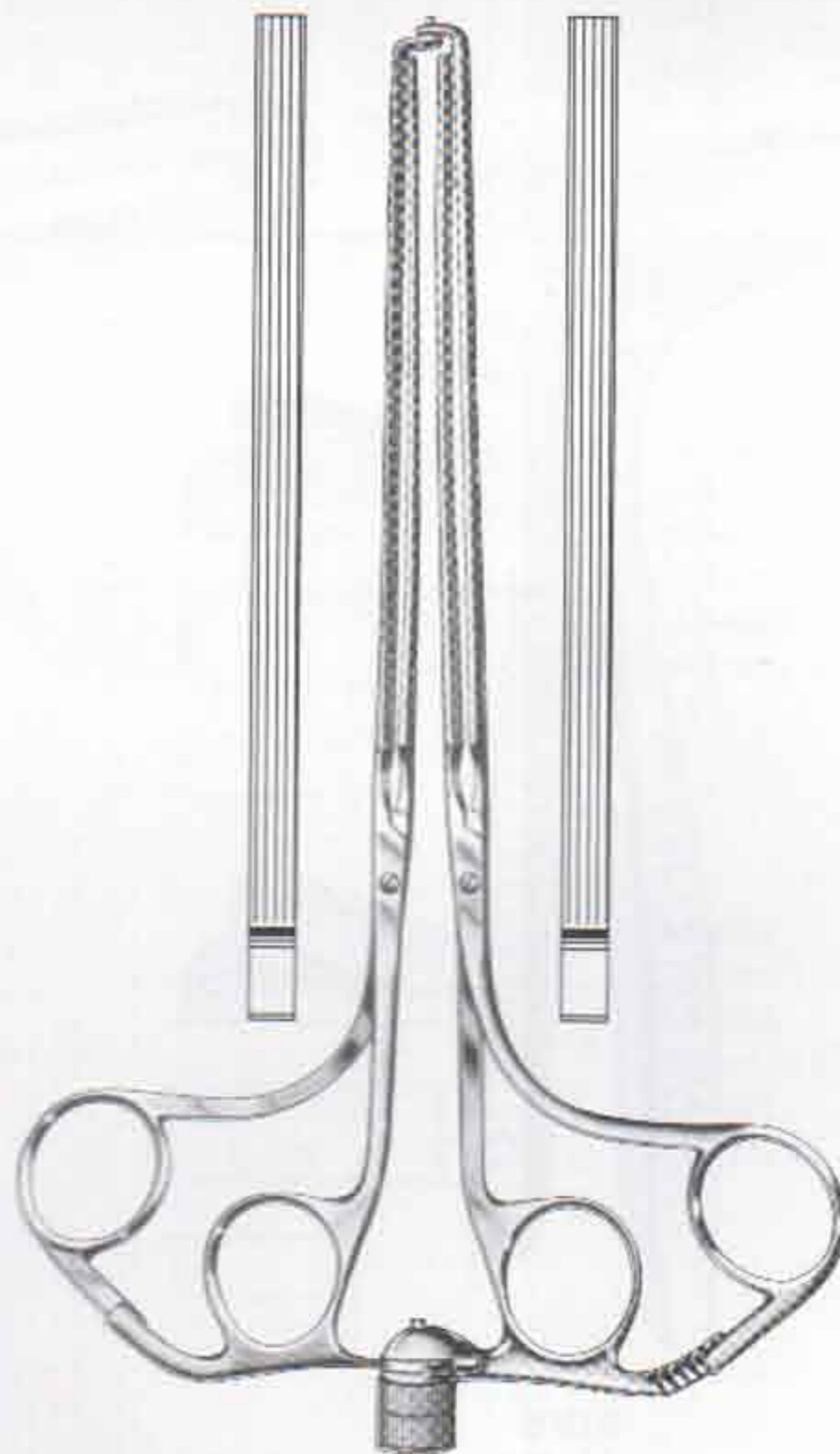

**ABADIE**  
**13-340**  
22cm 8 3/4"  
**13-341**  
27cm 10 1/2"



**LANE**  
**13-350**  
30 cm, 12"

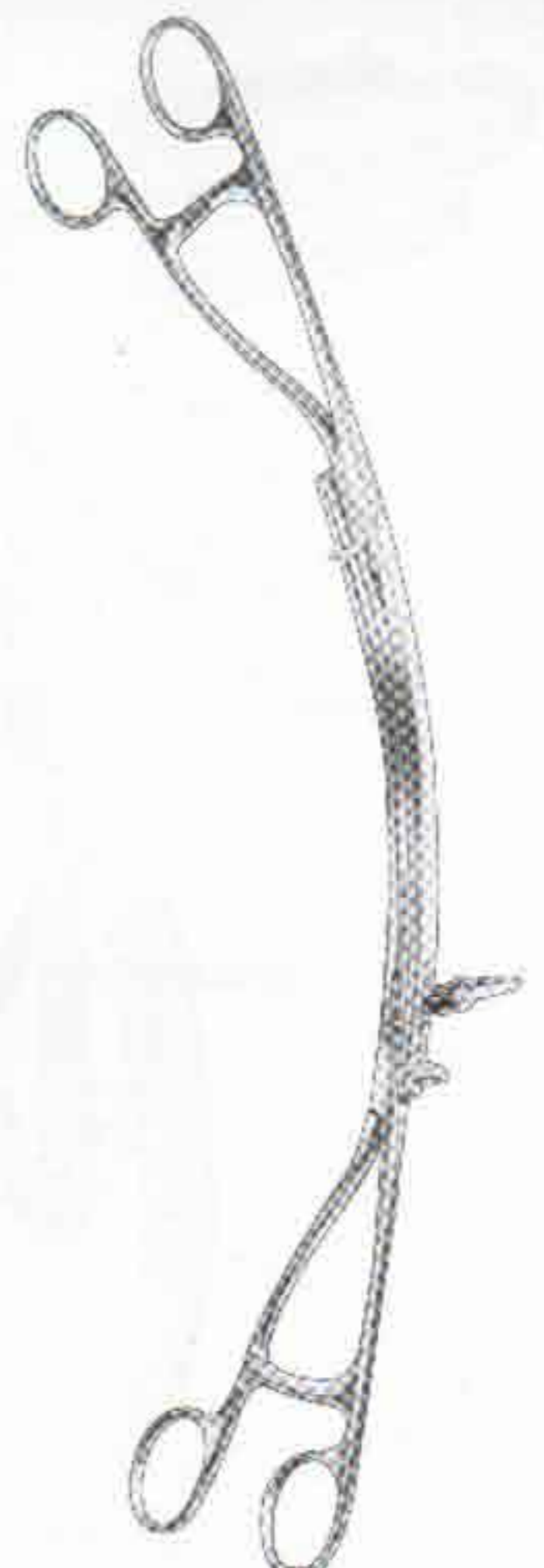

**LANE Cvd.**  
**13-360**  
30 cm, 12"

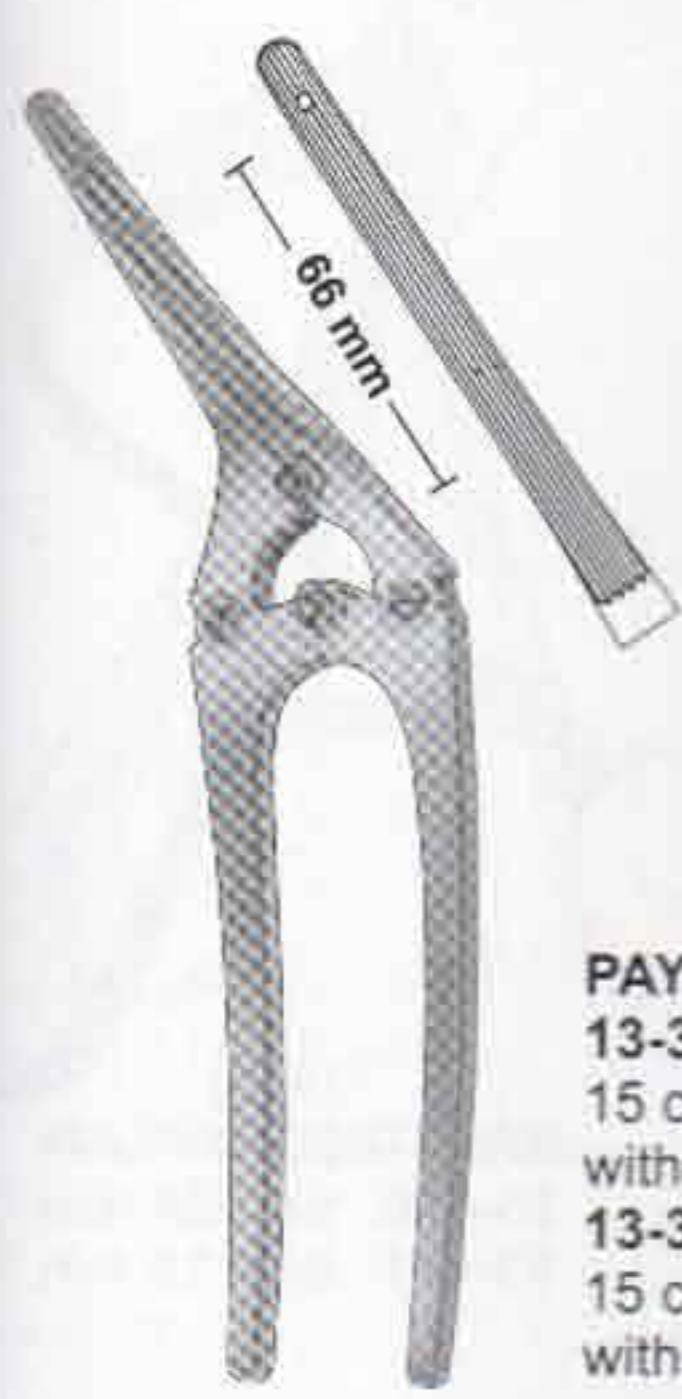

**PAYR-BABY**  
**13-370**  
15 cm, 6"  
without pin  
**13-371**  
15 cm, 6"  
with pin

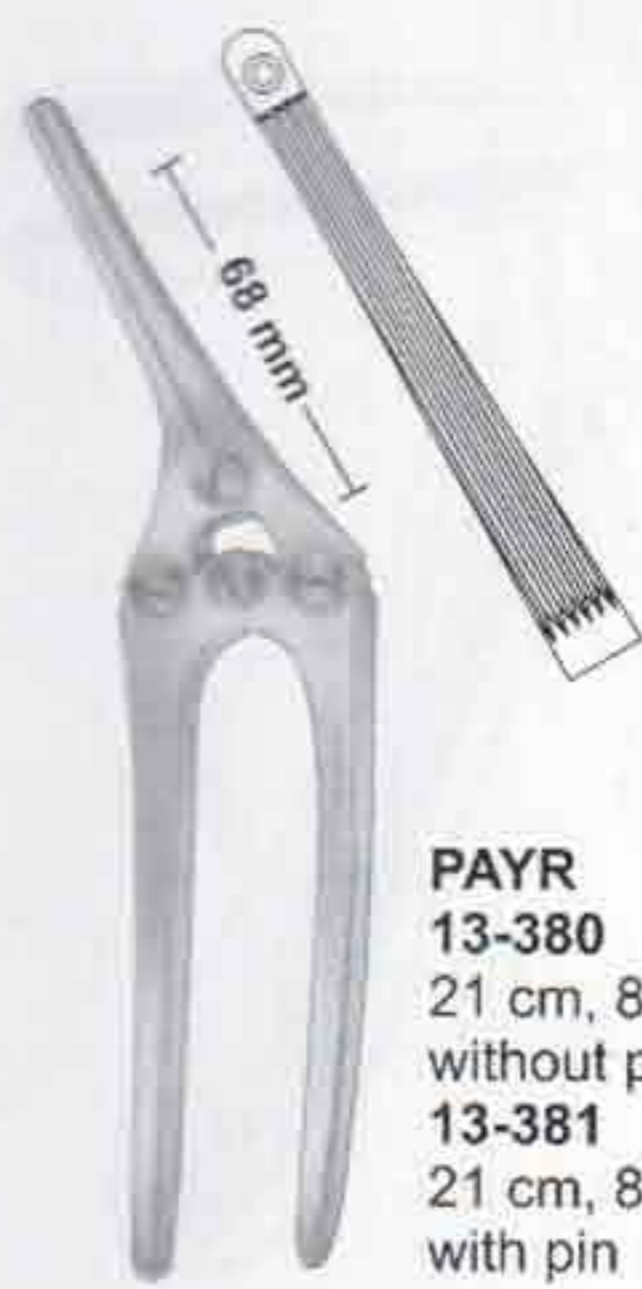

**PAYR**  
**13-380**  
21 cm, 8 1/4"  
without pin  
**13-381**  
21 cm, 8 1/4"  
with pin

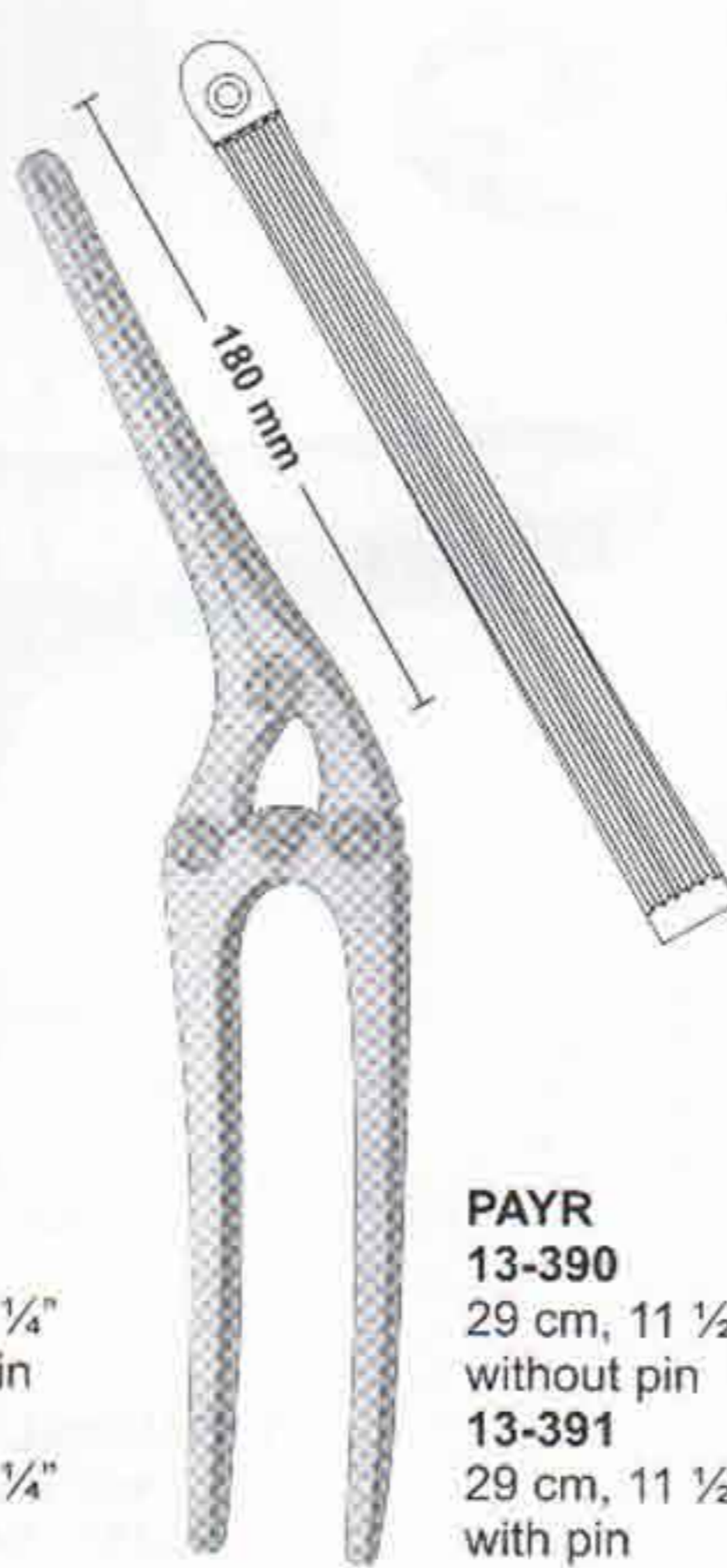

**PAYR**  
**13-390**  
29 cm, 11 1/2"  
without pin  
**13-391**  
29 cm, 11 1/2"  
with pin

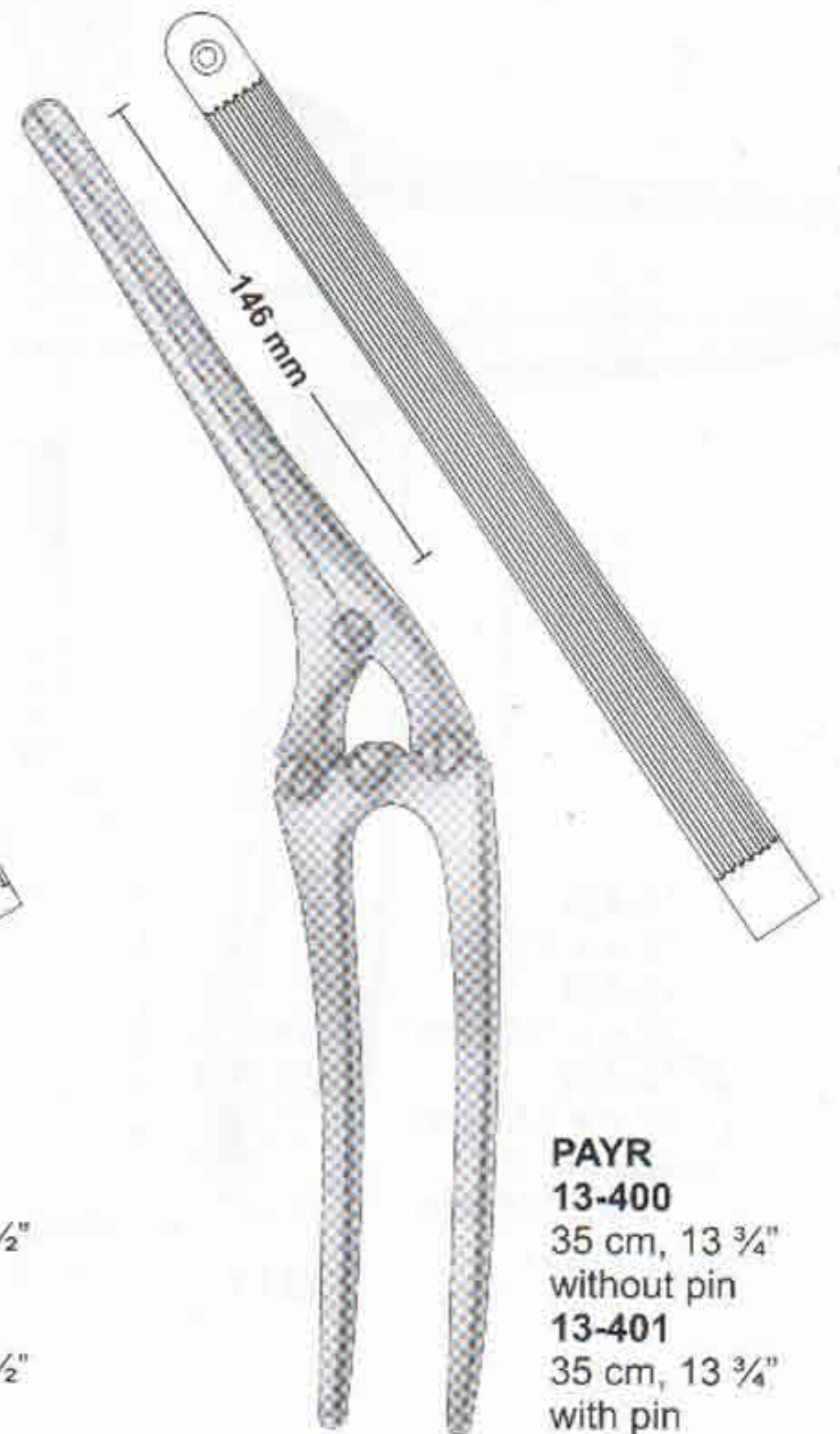

**PAYR**  
**13-400**  
35 cm, 13 3/4"  
without pin  
**13-401**  
35 cm, 13 3/4"  
with pin



# INTESTINAL RECTAL SPECULA

Mastdarmspekula  
Espéculos Rectales

Spéculums Rectaux  
Specoli Rettali

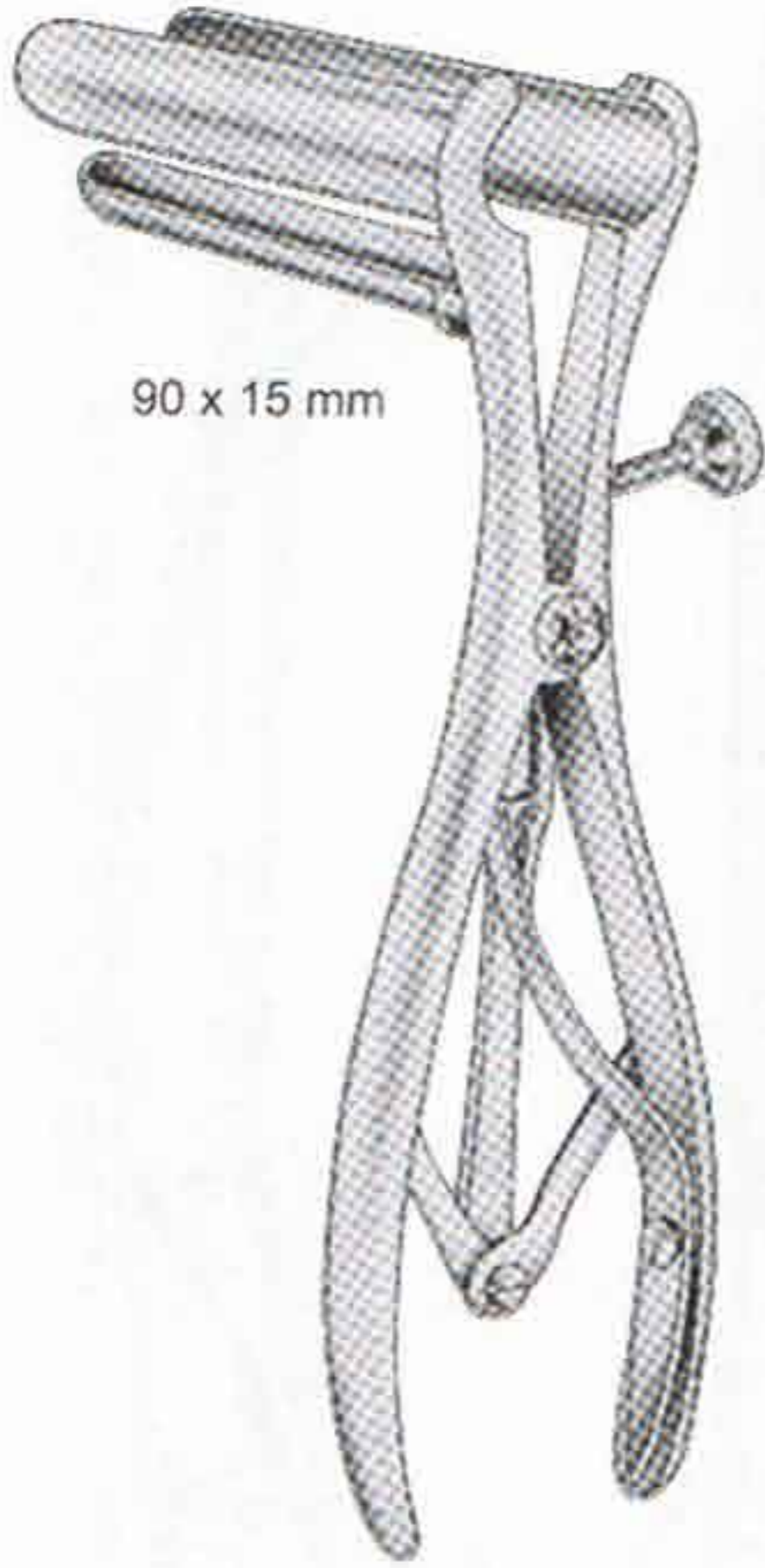

90 x 15 mm

**MATHIEU**  
13-410  
19.5 cm, 7 3/4"  
90 x 15 mm



**SIMS**  
13-420  
15 cm, 6"

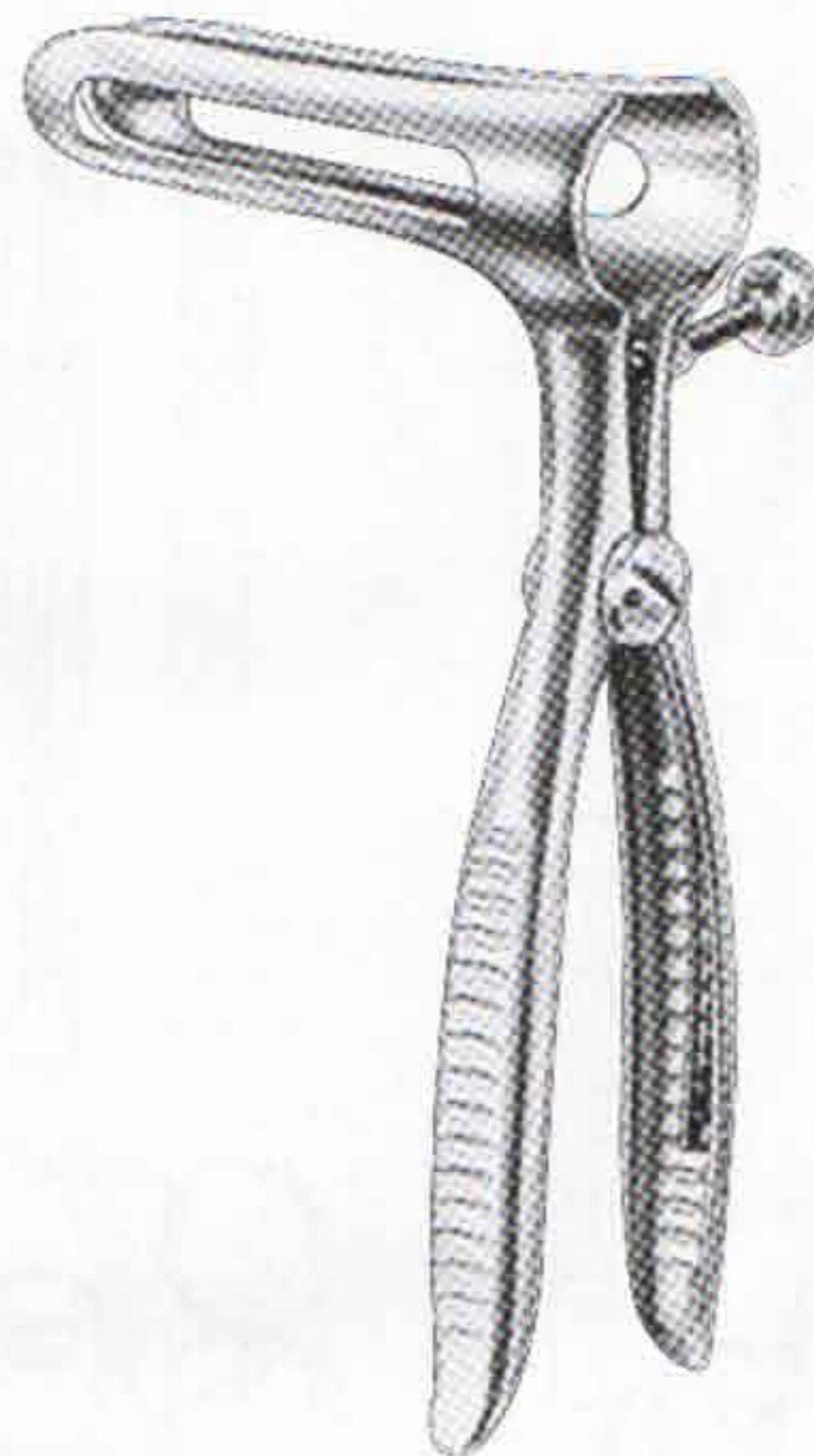

**SIMS**  
13-430  
15 cm, 6"

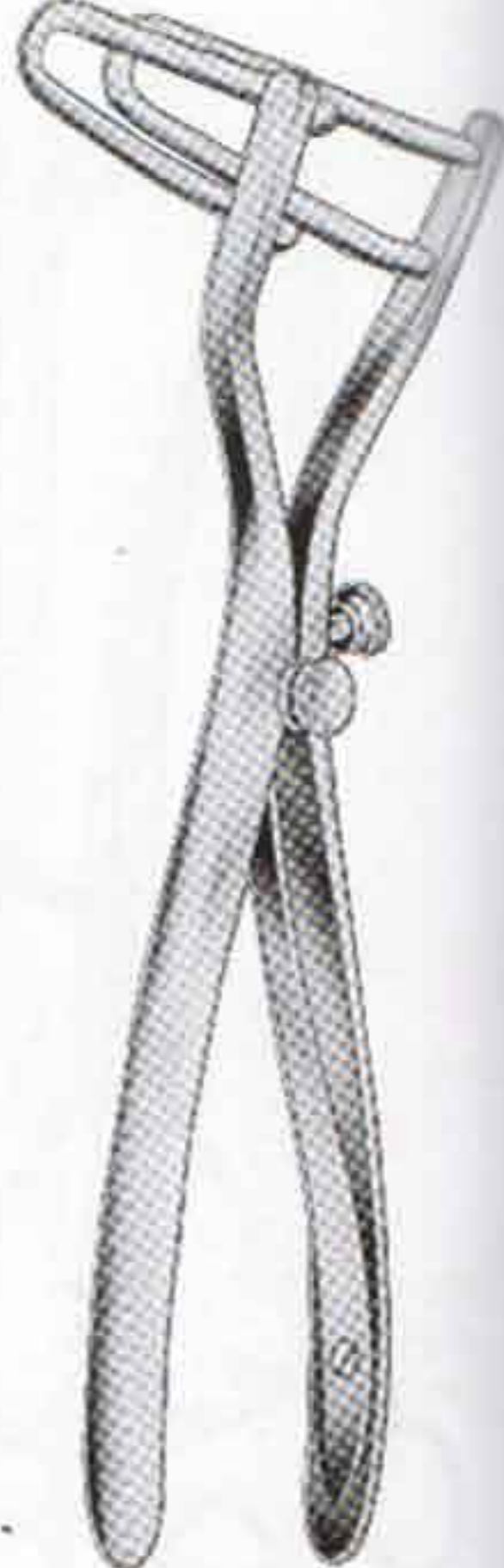

**Sims**  
13-440  
15 cm, 6"

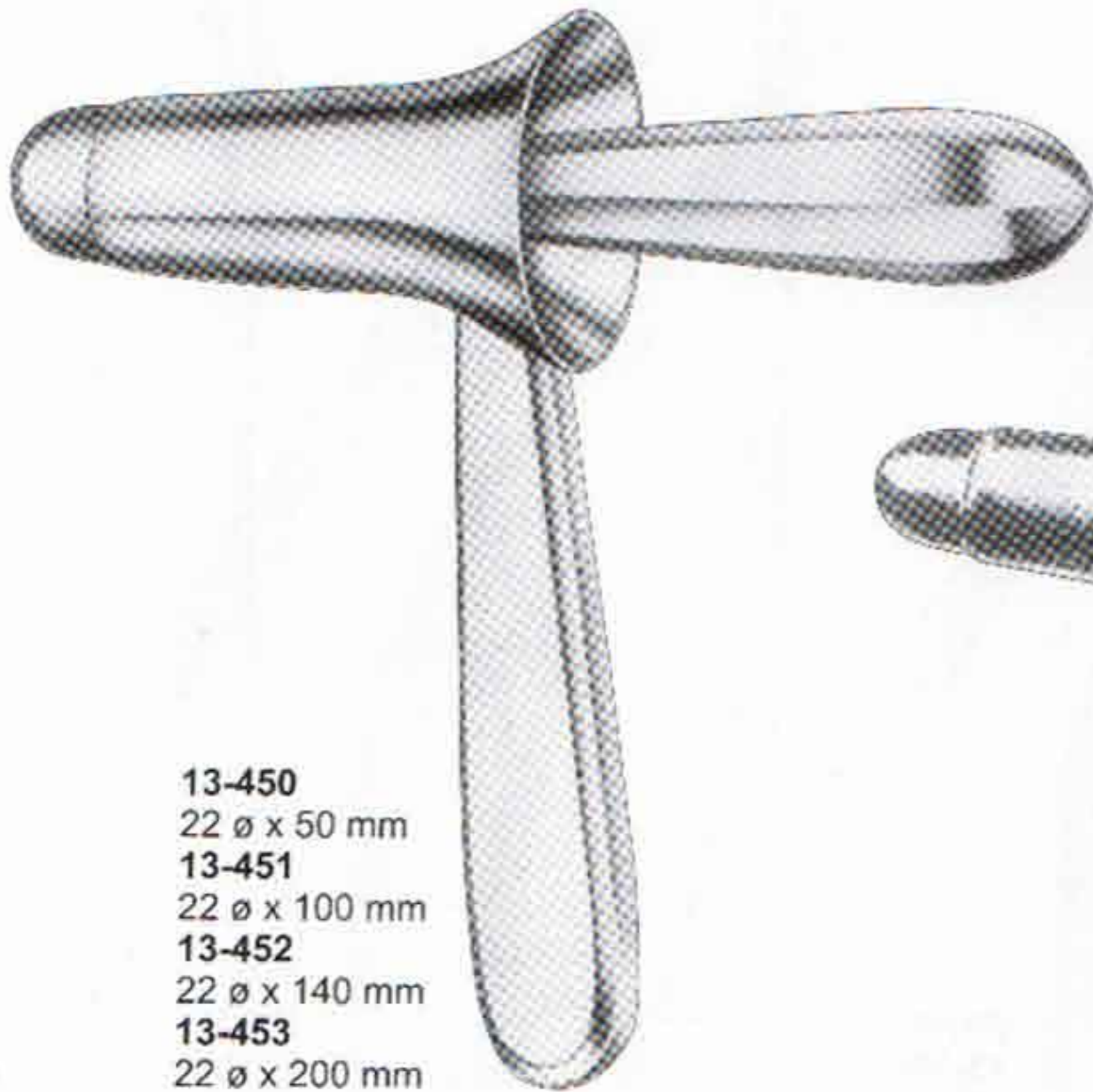

13-450  
22 ø x 50 mm  
13-451  
22 ø x 100 mm  
13-452  
22 ø x 140 mm  
13-453  
22 ø x 200 mm

**KELLY**

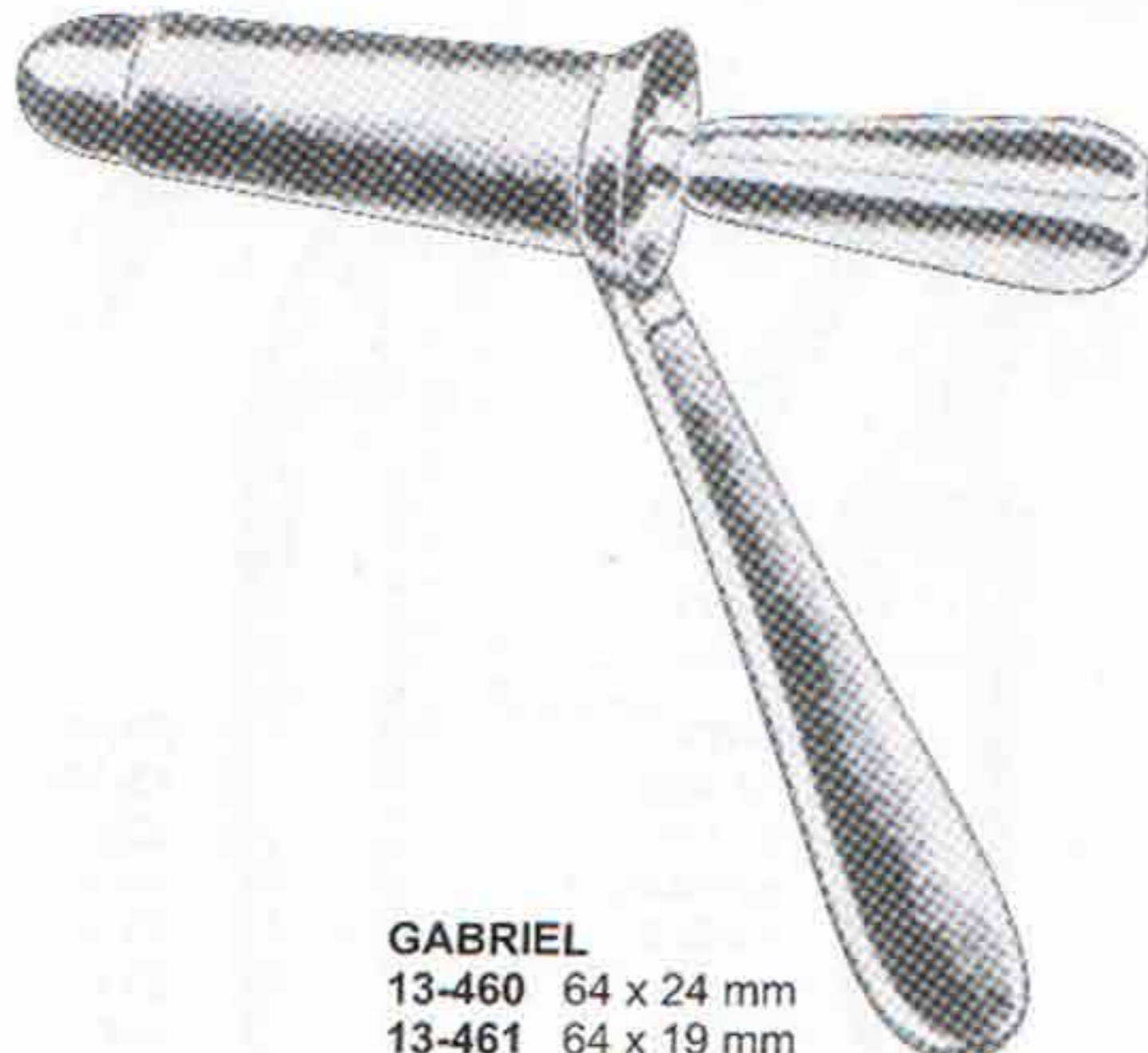

**GABRIEL**  
13-460 64 x 24 mm  
13-461 64 x 19 mm

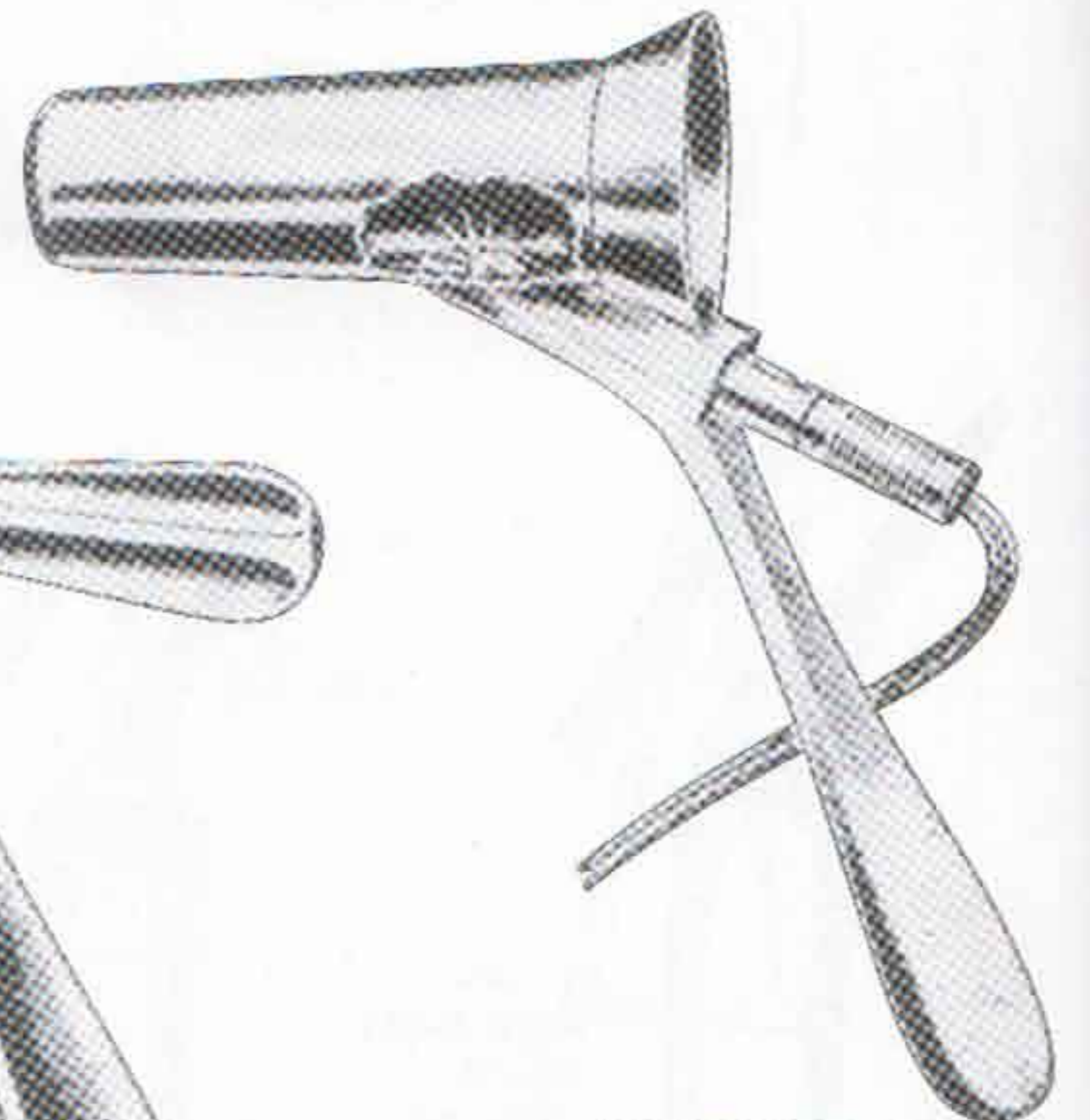

**NAUTON-MORGAN**  
13-470 64 x 24 mm  
13-471 64 x 19 mm



# POLYOUS GRASPING FORCEPS, ANASTOMOSIS



Poliperfossange, Darm-anastomosenklemmen

Pince Pour Saisir Polypes, Pinces-clamps Pour Anastomose Intestinale

Pinza Para Coger Polipos, Clamps Para Anastomosis Intestinales

Pinze Per Afferrare Polipi, Pinze Per Anastomosi Intestinali

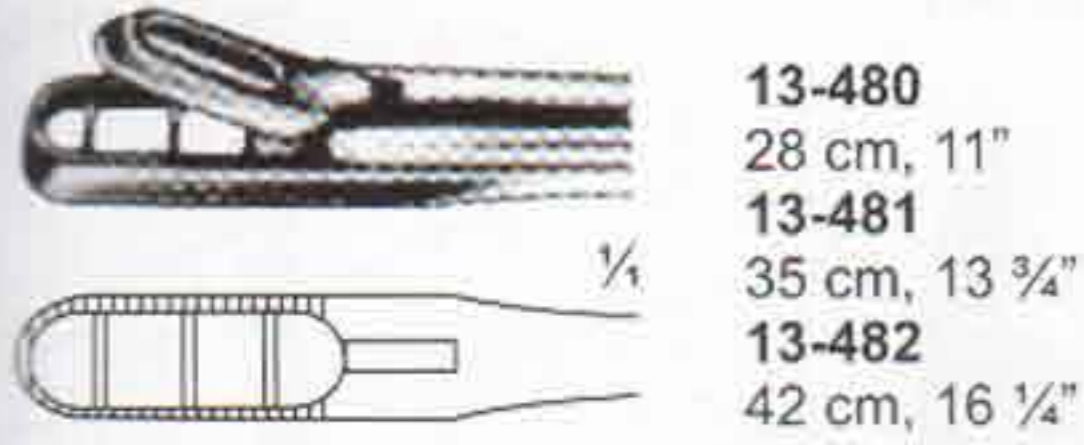
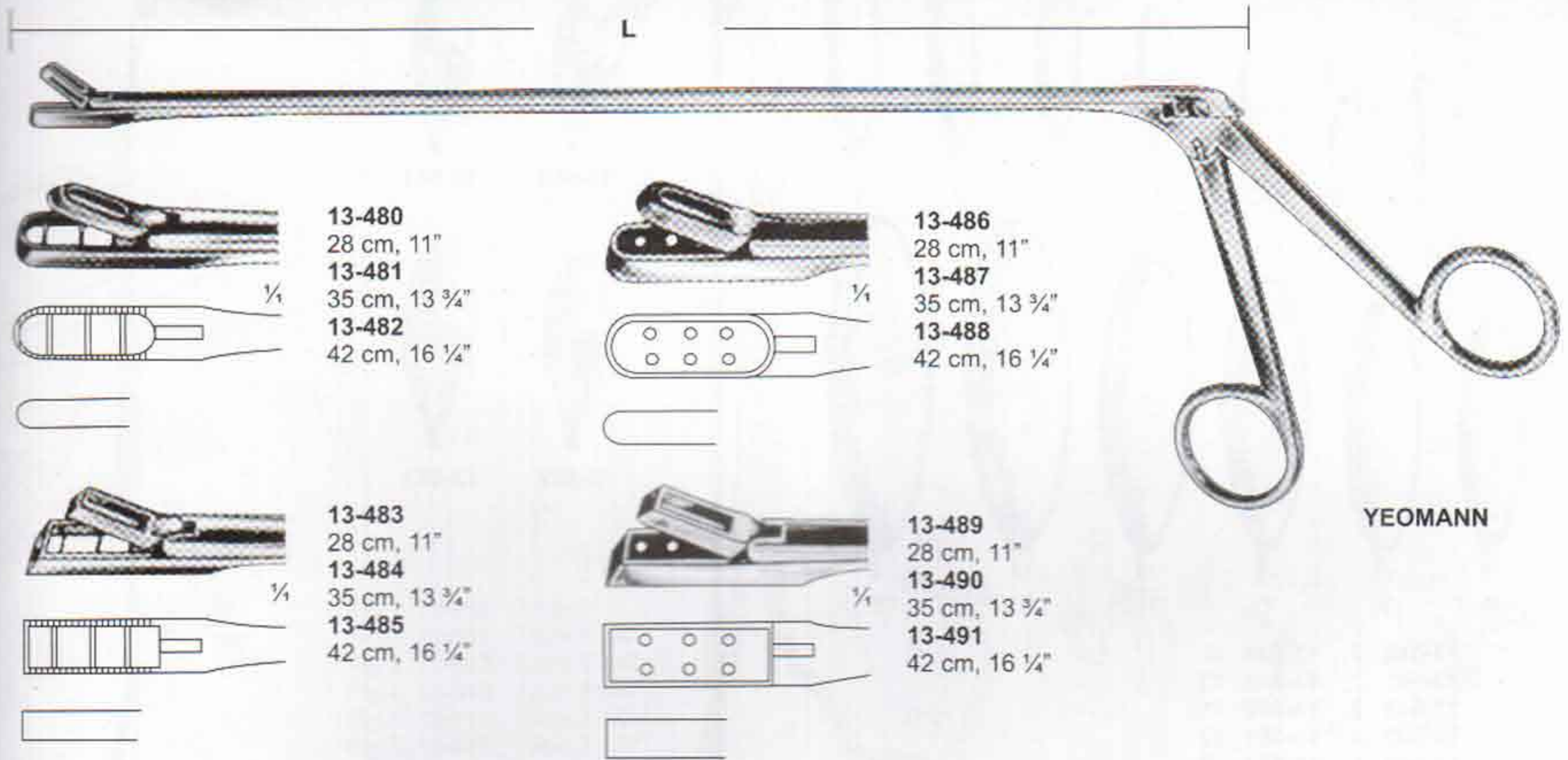

**13-480**  
28 cm, 11"  
**13-481**  
35 cm, 13 3/4"  
**13-482**  
42 cm, 16 1/4"

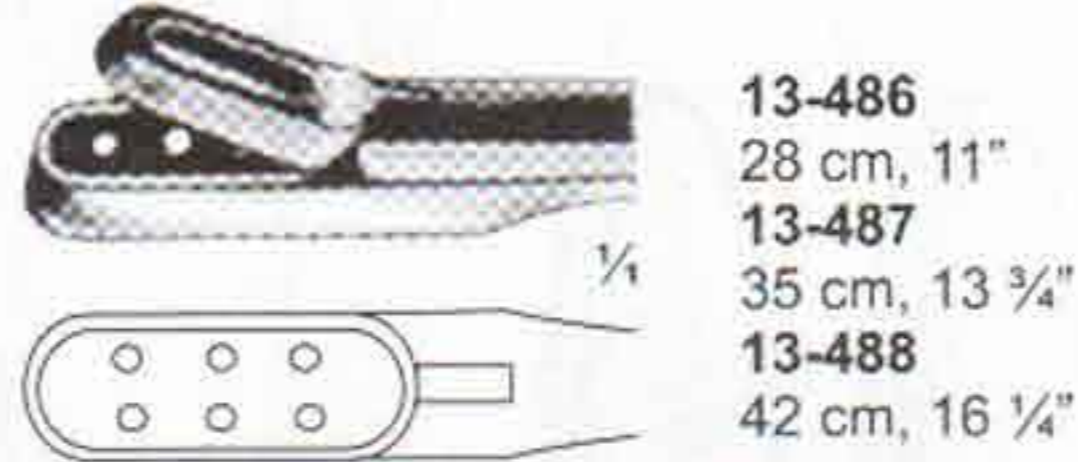

**13-486**  
28 cm, 11"  
**13-487**  
35 cm, 13 3/4"  
**13-488**  
42 cm, 16 1/4"

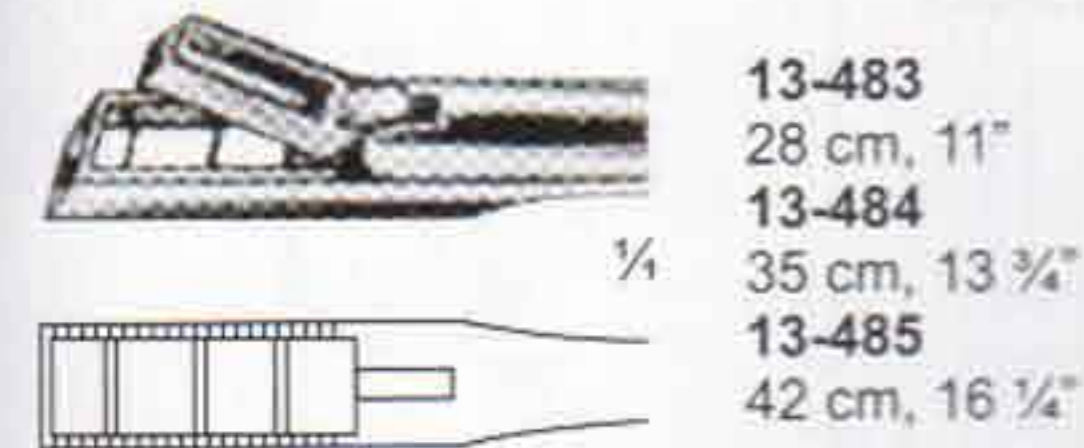

**13-483**  
28 cm, 11"  
**13-484**  
35 cm, 13 3/4"  
**13-485**  
42 cm, 16 1/4"

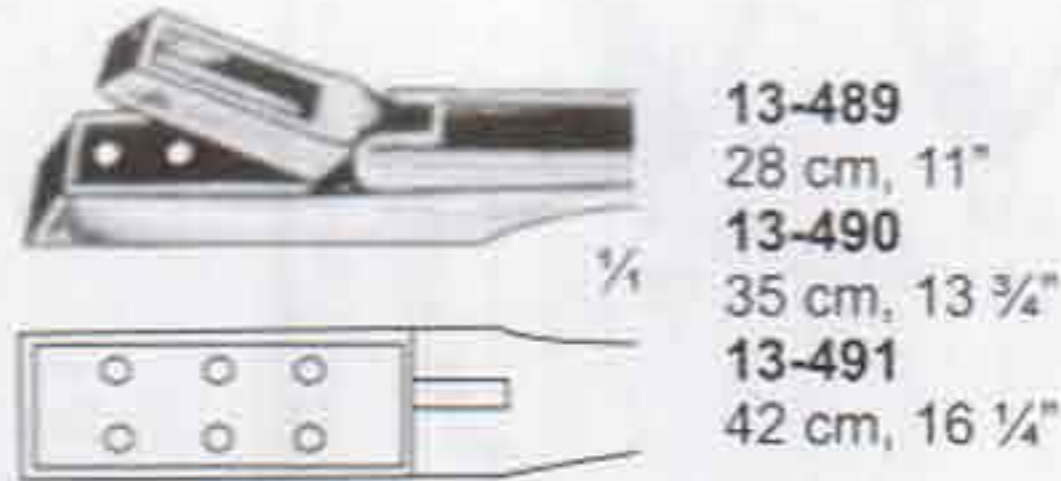

**13-489**  
28 cm, 11"  
**13-490**  
35 cm, 13 3/4"  
**13-491**  
42 cm, 16 1/4"

**YEOMANN**

## PILE FORCEPS

## COTTON CARRIER

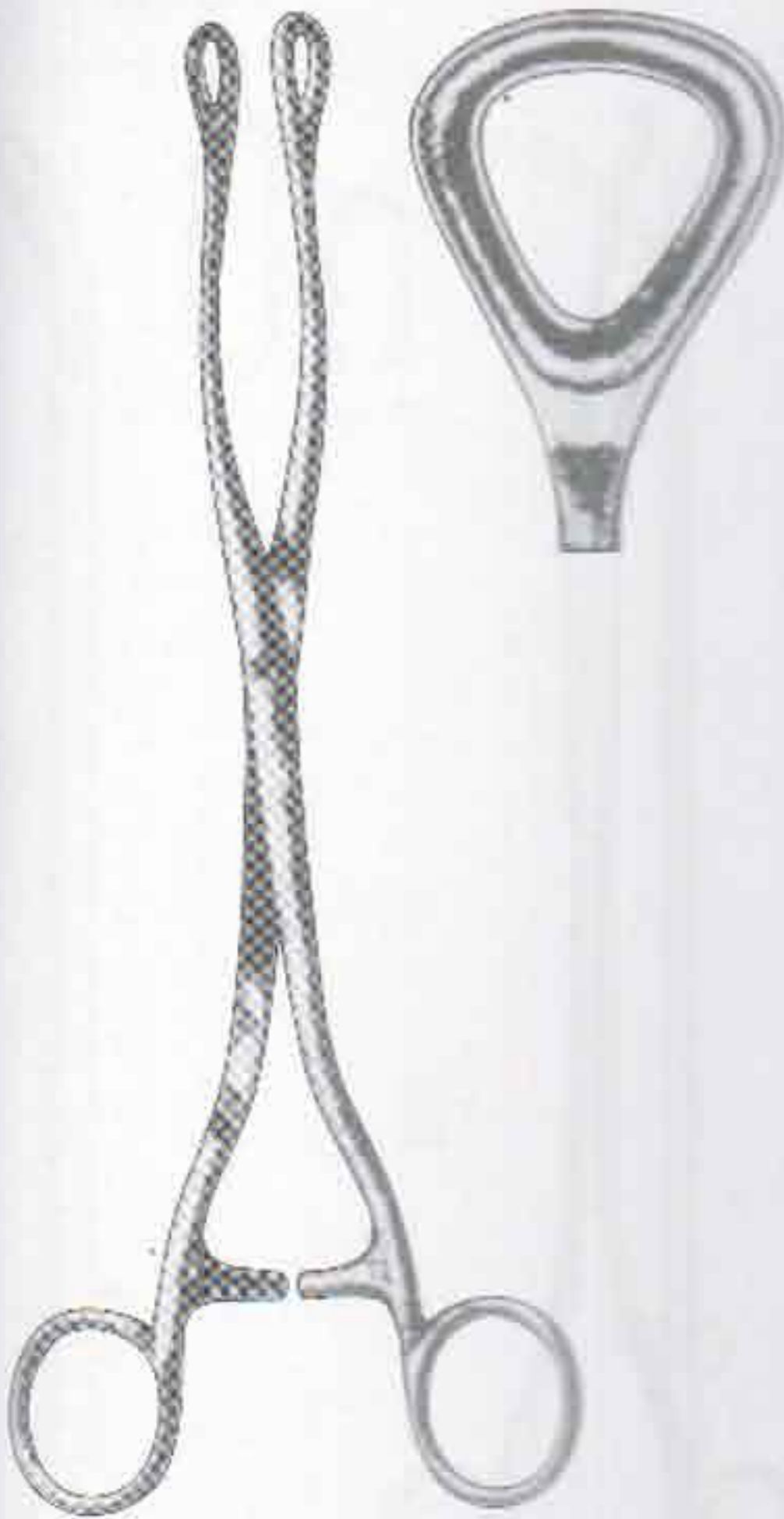

**LURE**  
13-500 24.5cm



**JARVIS**  
13-510 23cm

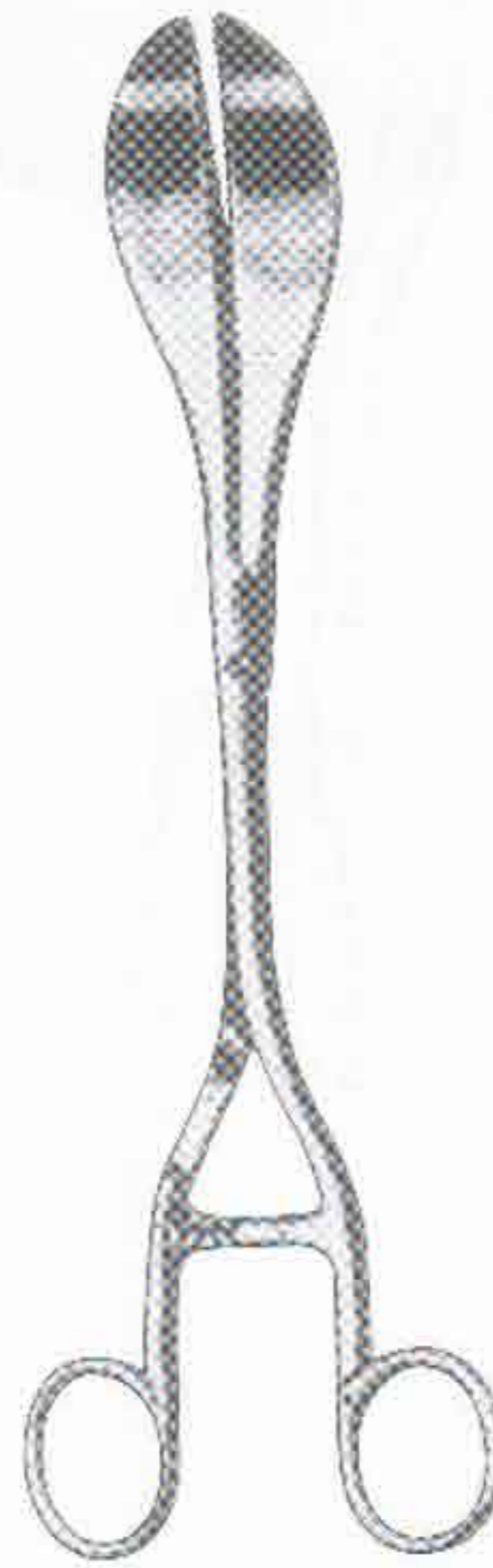

**LANGENBECK**  
13-520 45cm



13-530 45cm



# GALL STONE FORCEPS

Gallensteinzangen  
Gallensteinlöffel

Pinces pour calculs biliaires  
Curettes pour calculs biliaires

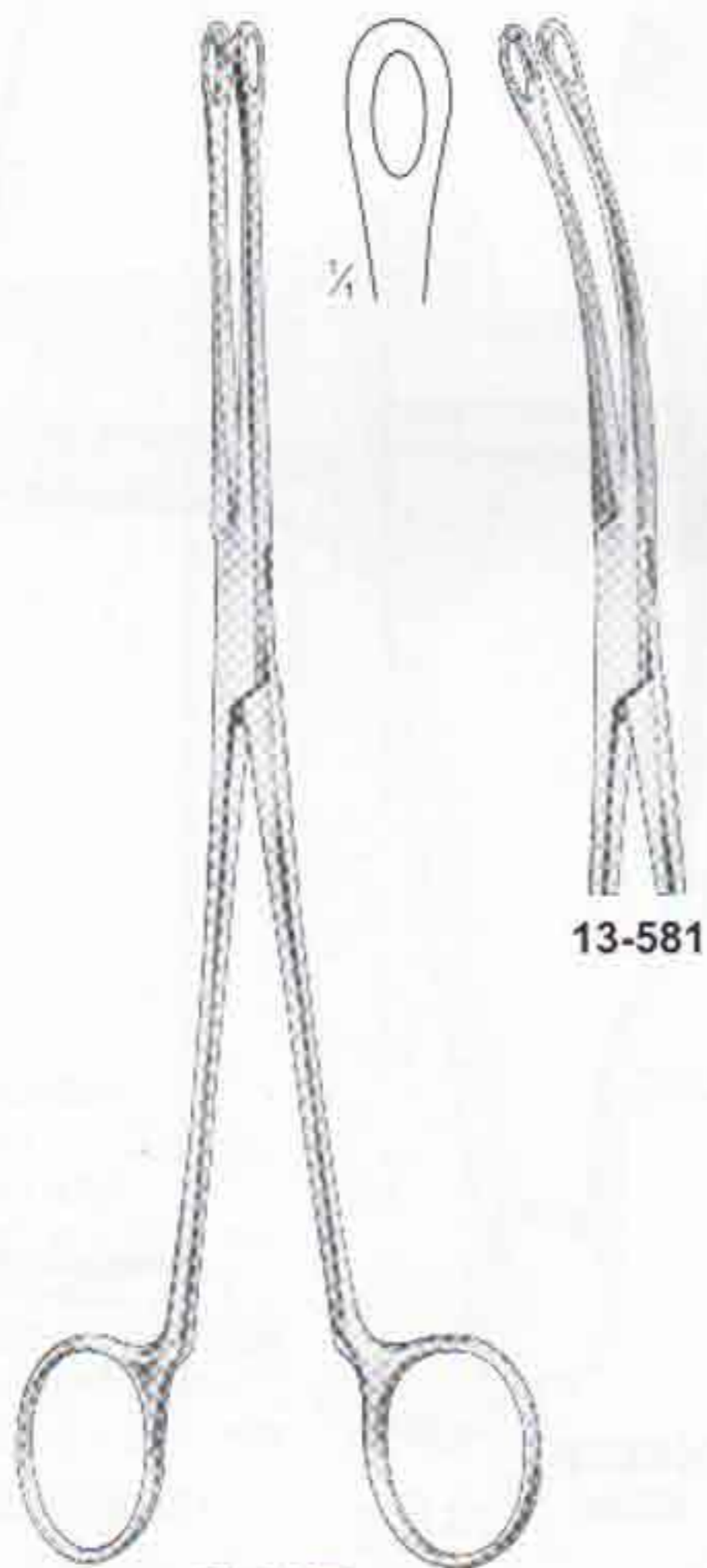
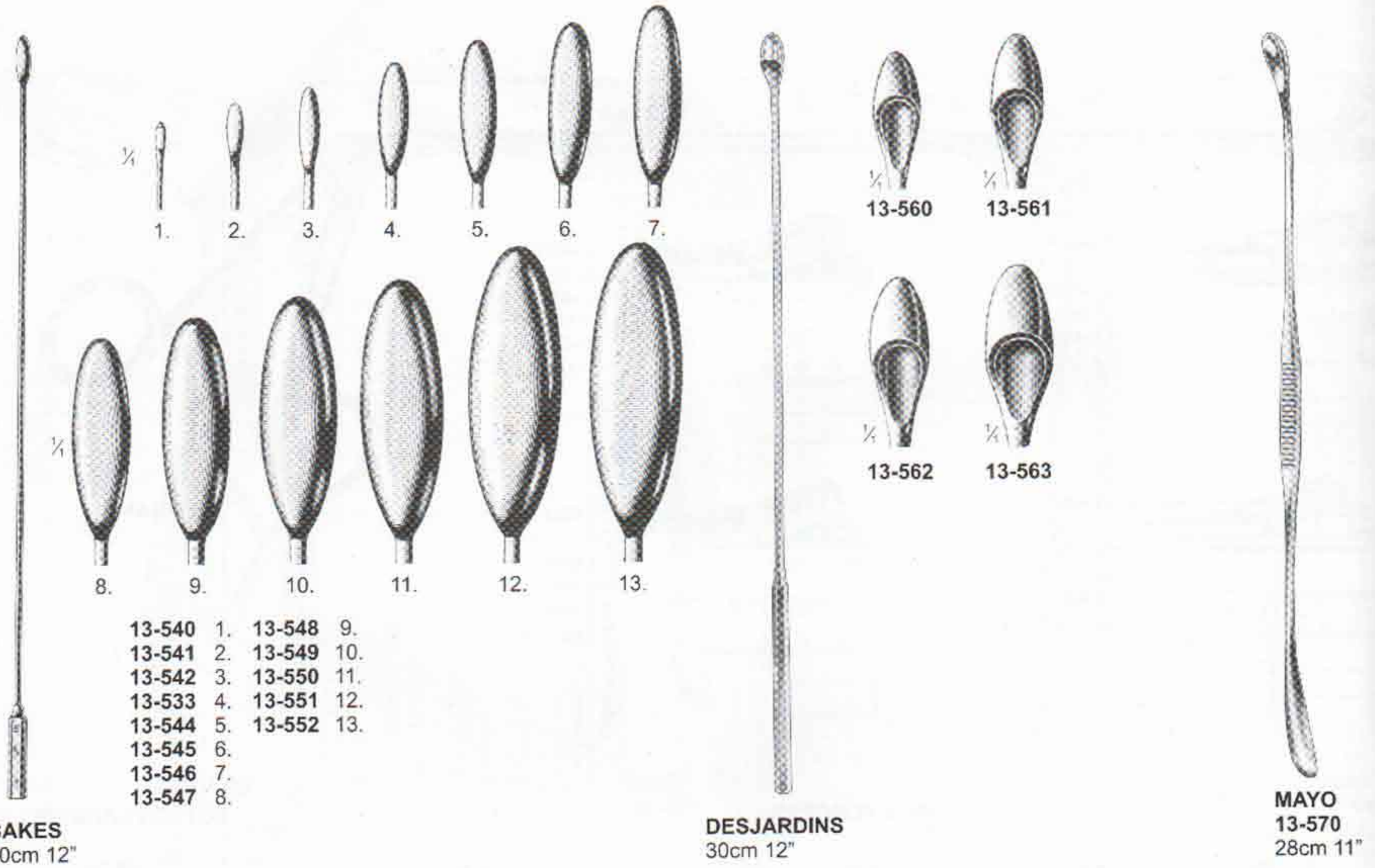

**BLAKE**  
13-580  
20cm 8"

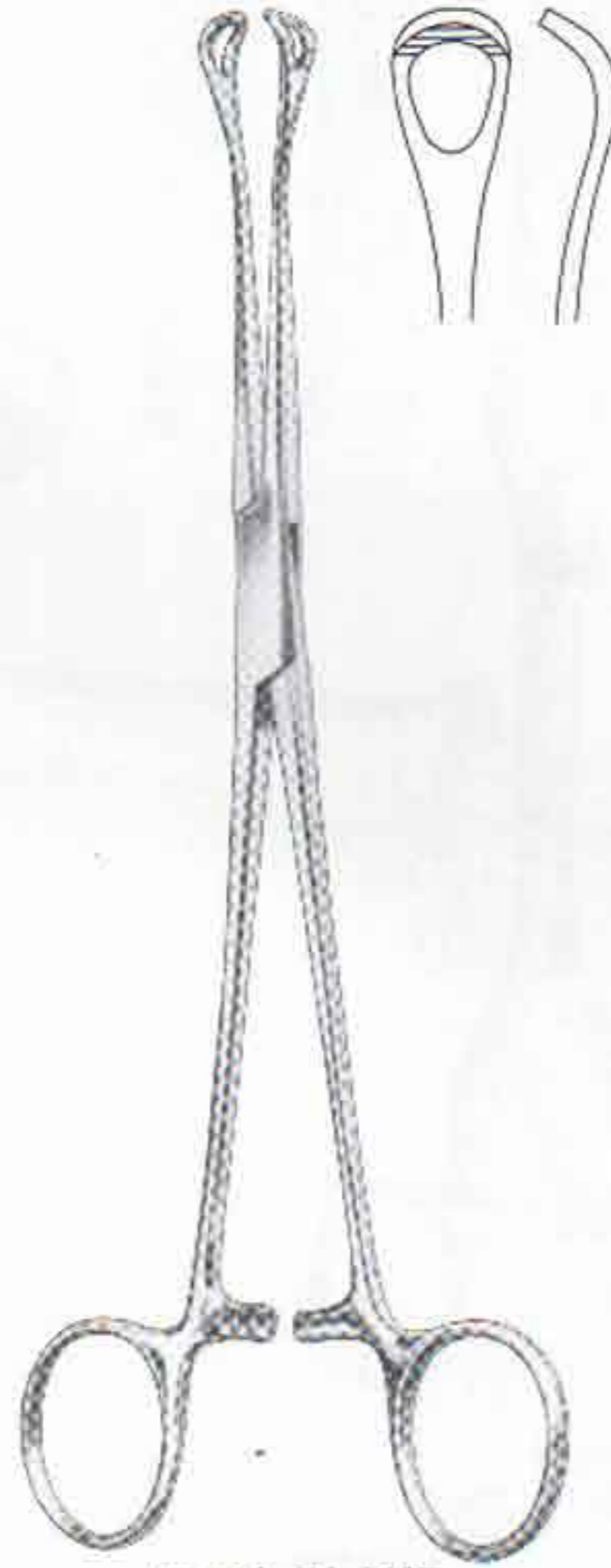

**MAYO-BLAKE**  
13-590  
20cm 8"

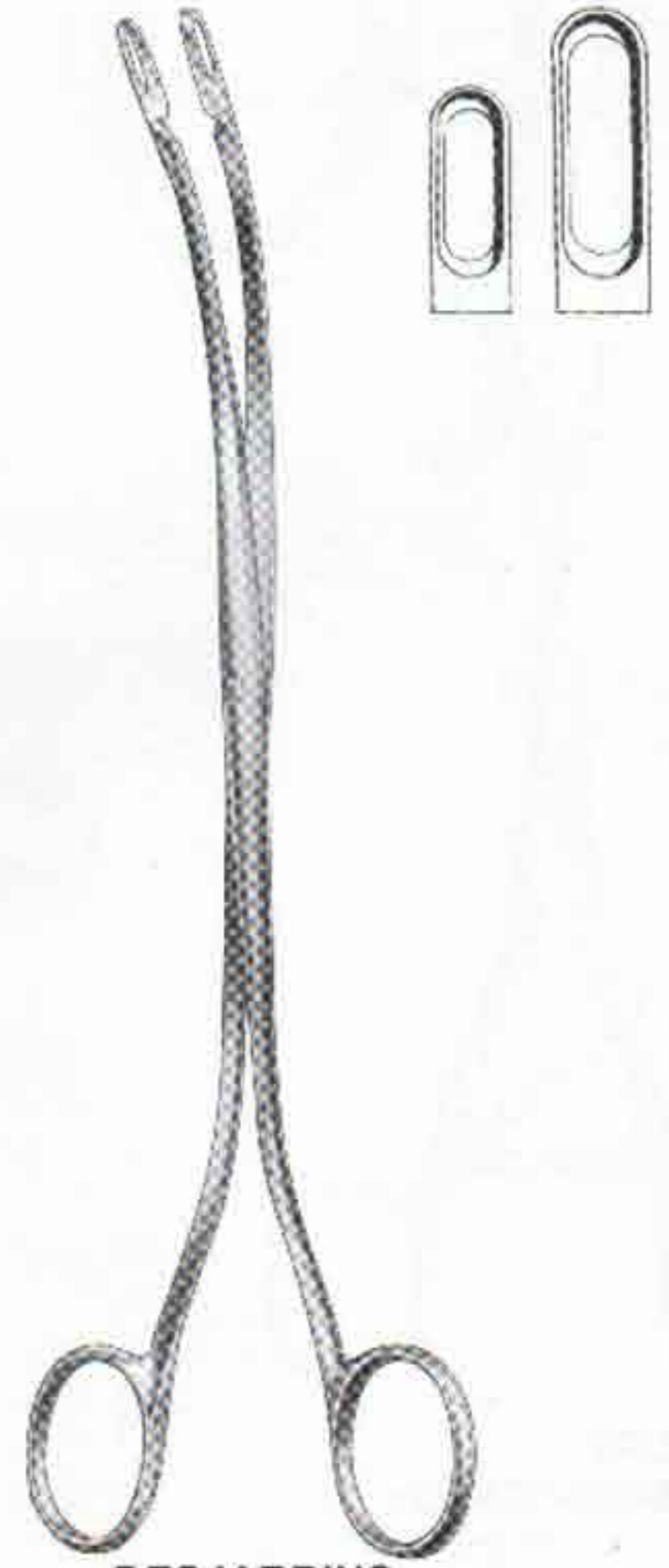

**DESJARDINS**  
13-600  
23cm 9"



# URETHRAL CATHETERS

Urethalkatheter  
Sondes Urétrales

Cateteri Uretrali  
Catéteres Uretrales

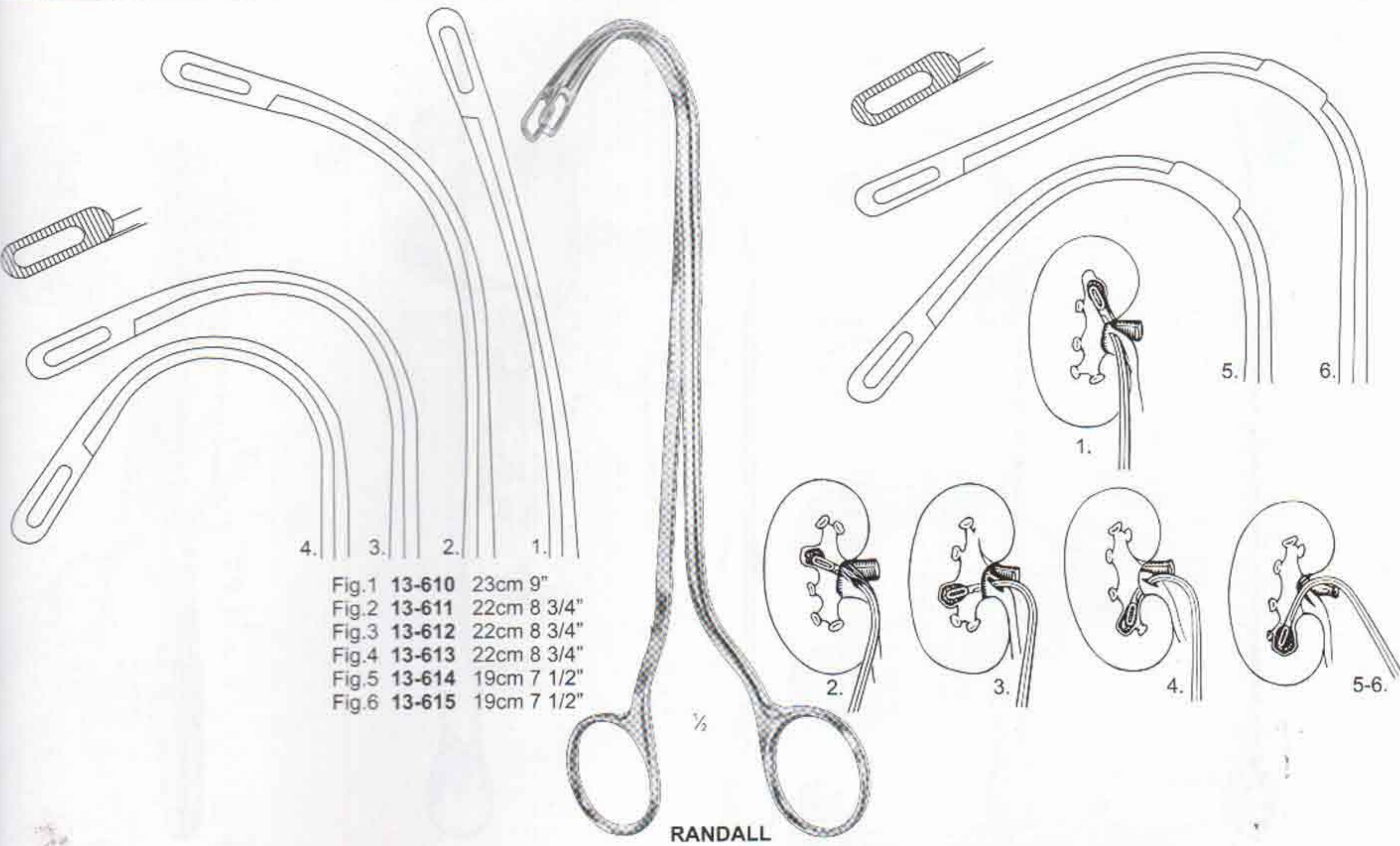

Fig.1 13-610 23cm 9"  
Fig.2 13-611 22cm 8 3/4"  
Fig.3 13-612 22cm 8 3/4"  
Fig.4 13-613 22cm 8 3/4"  
Fig.5 13-614 19cm 7 1/2"  
Fig.6 13-615 19cm 7 1/2"

RANDALL



**CATHETER**  
13-620  
15 cm, 6"  
No. 6-16

**CATHETERS**  
13-630 29 cm, 11 1/2"  
Male Catheters charr., Metal  
French  
13-631 8  
13-632 10  
13-633 12  
13-634 14  
13-635 16  
13-636 18  
13-637 20

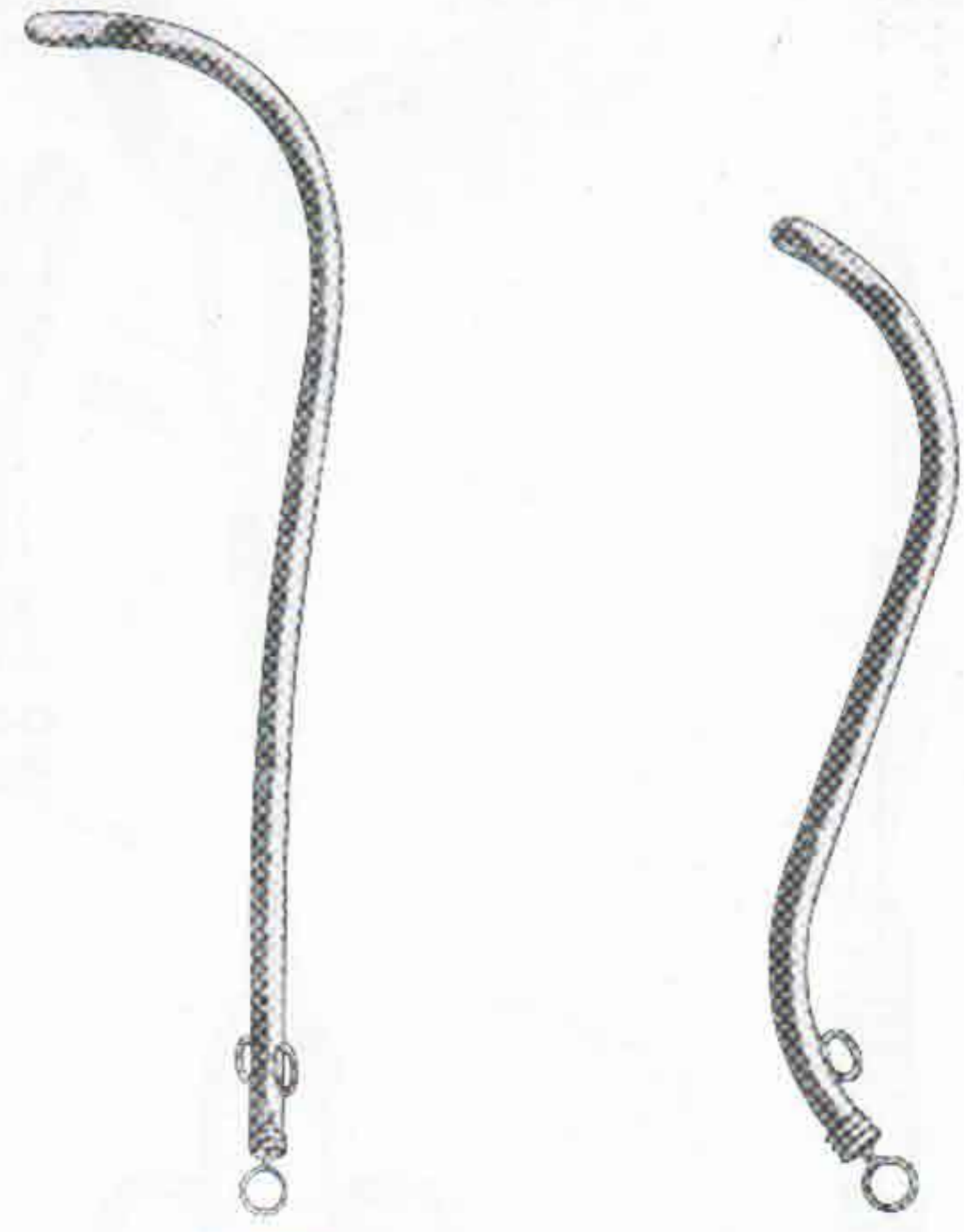

**COXETER**  
13-640 28 cm  
8 Fg To 24 Fg

13-650 20 cm  
8 Fg To 24 Fg



# URETHRAL CATHETERS

Urethalkatheter  
Sondes Urétrales

Cateteri Uretrali  
Catéteres Uretrales

## Urethral Bougies

## Directors



**LISTER**  
13-660  
00/1 to 15/18



**CLUTTON**  
13-670  
6/10fg. To 28/32f.g



**STONE**  
13-680  
6eg. To 12eg



**WHEELHOUSE**  
13-690



**CHILD**  
13-700



**KEY**  
13-710



**LEWKOWITZ**  
13-720 26 cm  
13-721 26 cm



**13-722**  
26 cm

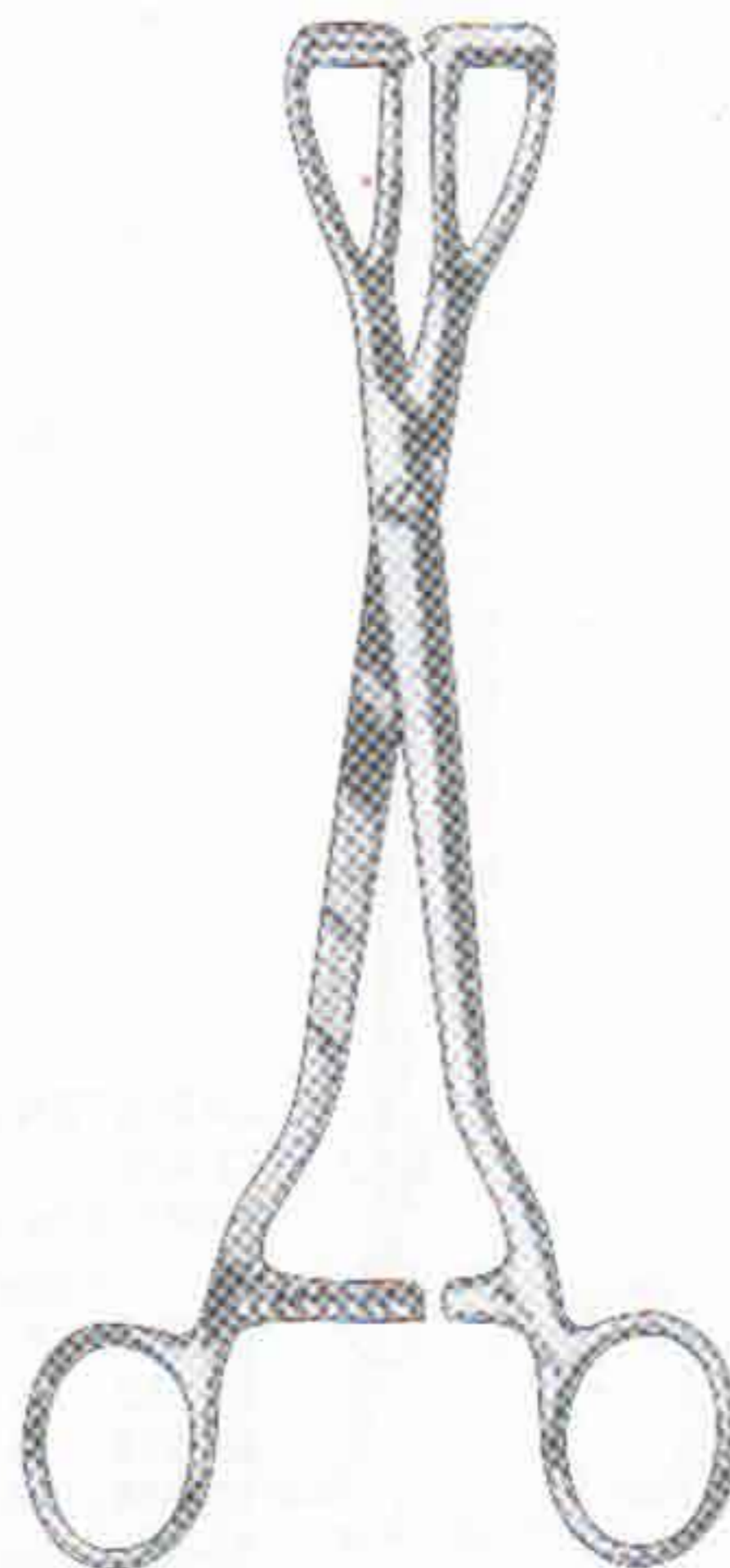

**YOUNG**  
13-730 20 cm



# BLADDER NECK SPREADER, BLADDER RETRACTORS



Blasenhalsperrer, Blasenwundsperrer

Ecarteur pour le col de la vessie, Ecarteurs vésicaux

Dilatador para el cuello vesical, Separadores vesicales

Divaricatore del collo vescicale, Divaricatore vescicale

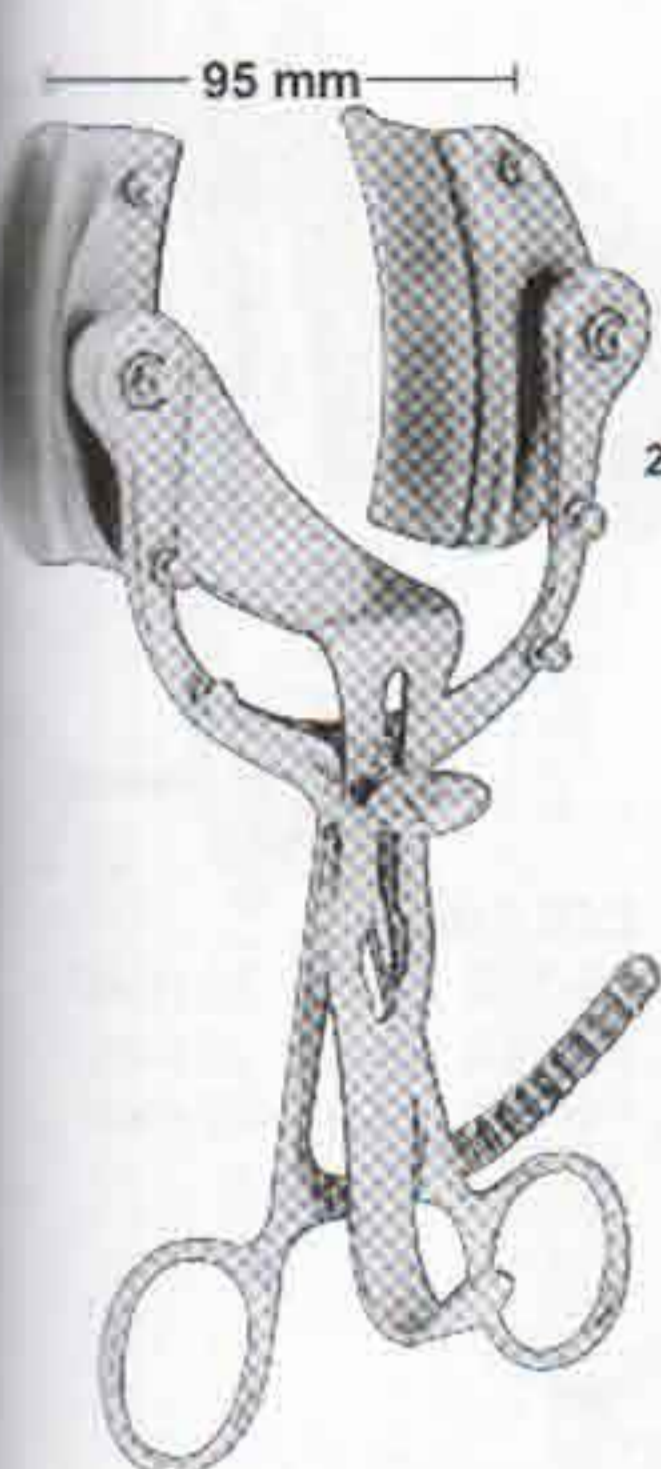

**LEGUEU**  
13-740  
17 cm, 6 3/4"

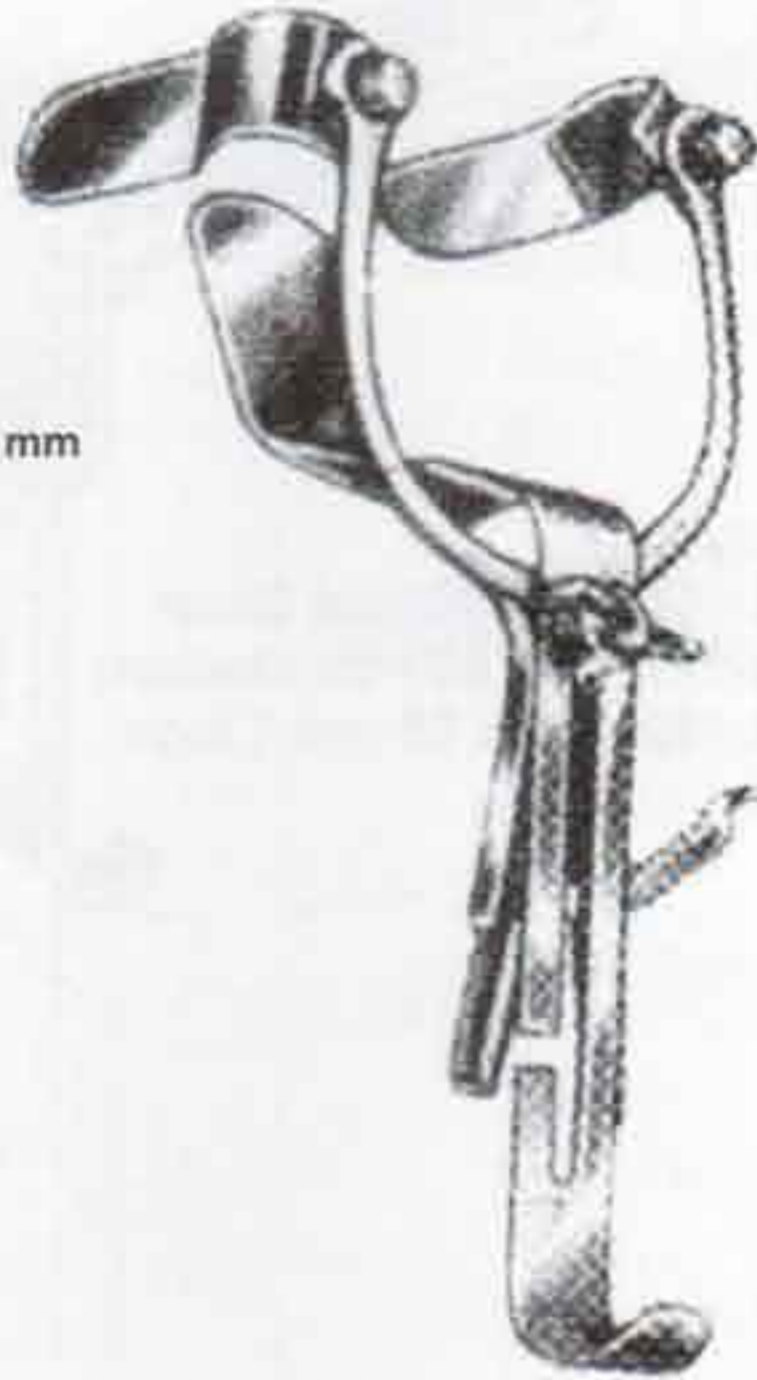

**MILLIN**  
13-750



**MILLIN**  
13-760  
28 cm, 11"

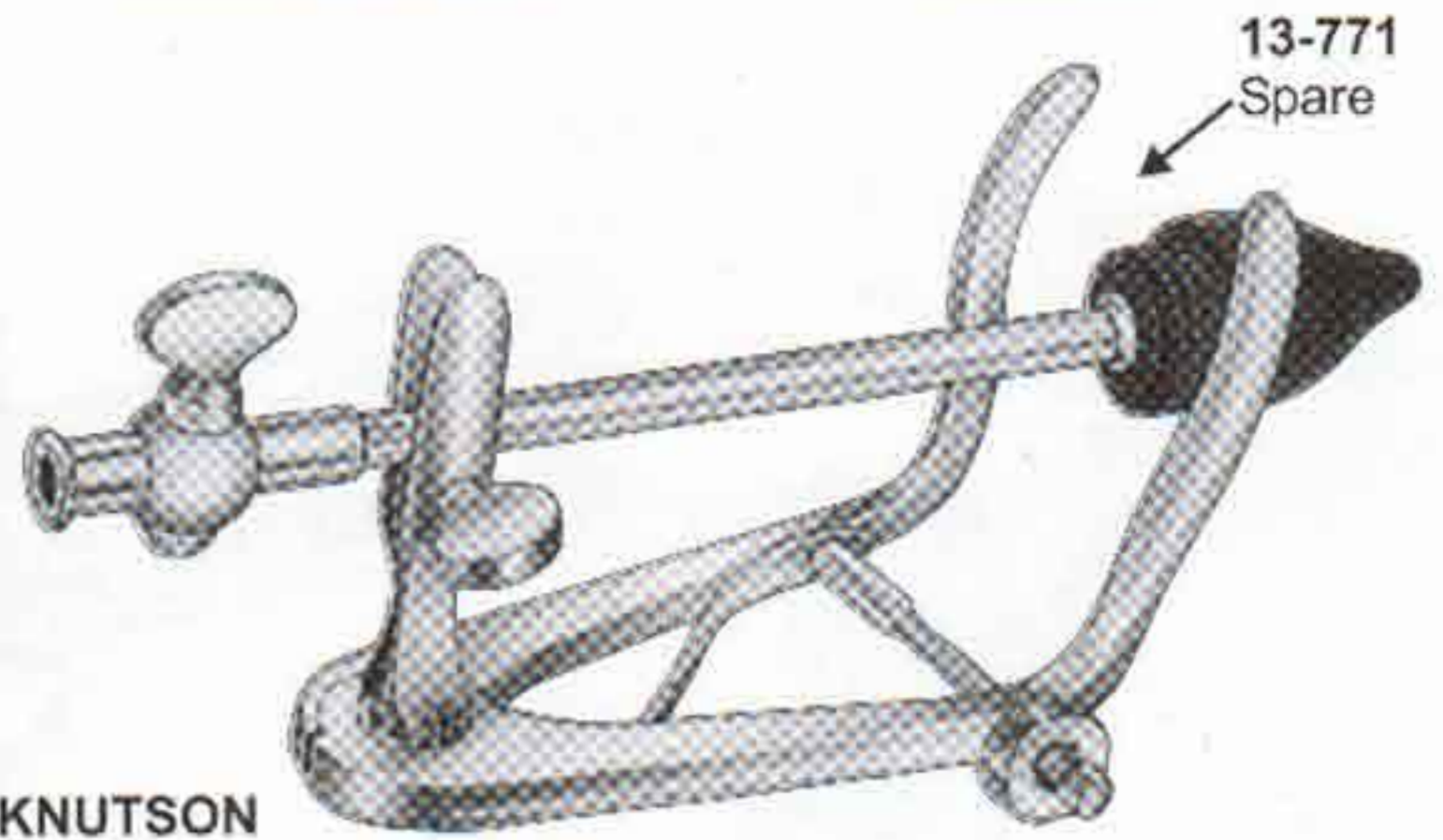

**KNUTSON**  
13-770  
18 cm, 7"  
Urethrographie-Instruments

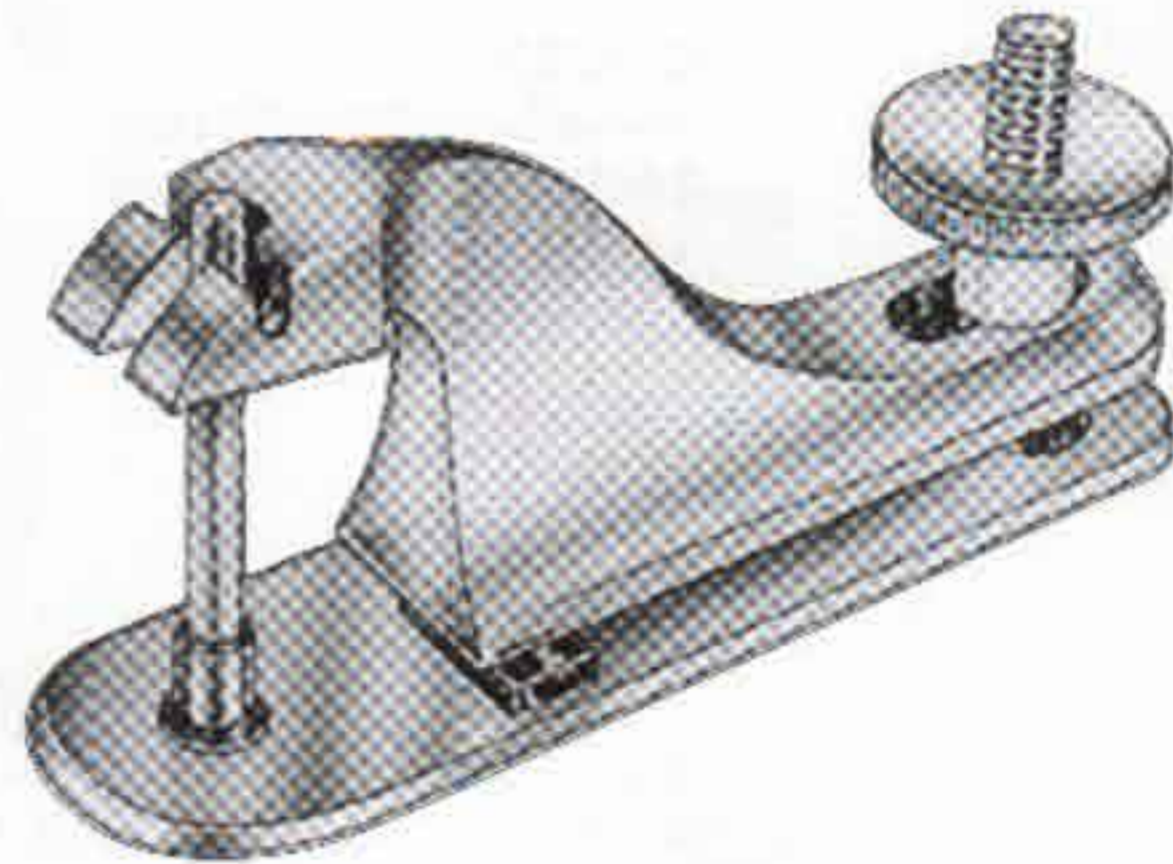

GUMCO CLAMP	mm ø
13-780	8
13-781	11
13-782	13
13-783	16
13-784	21
13-785	26
13-786	32

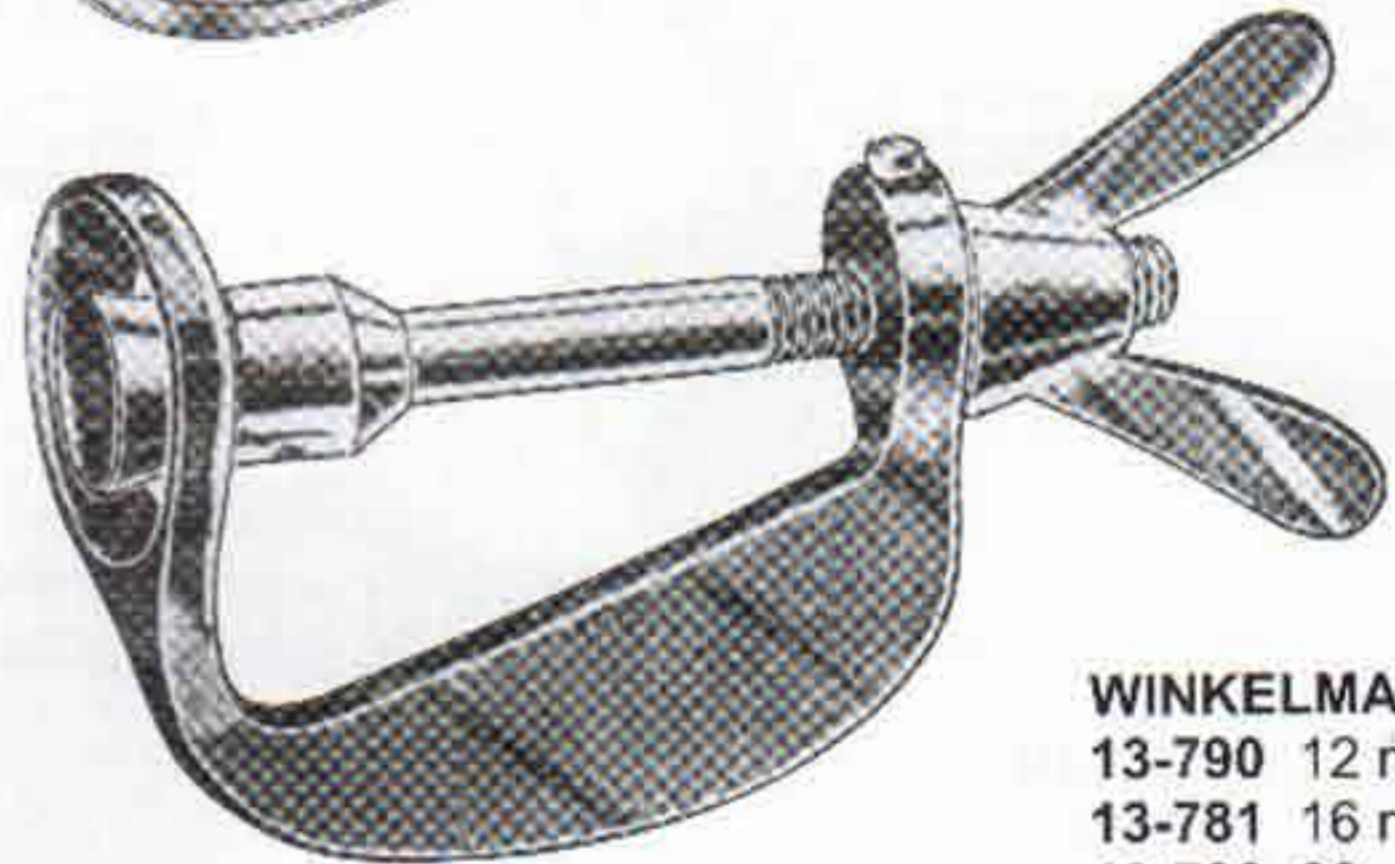

**WINKELMANN**  
13-790 12 mm Ø  
13-781 16 mm Ø  
13-782 20 mm Ø  
Circumcision clamps

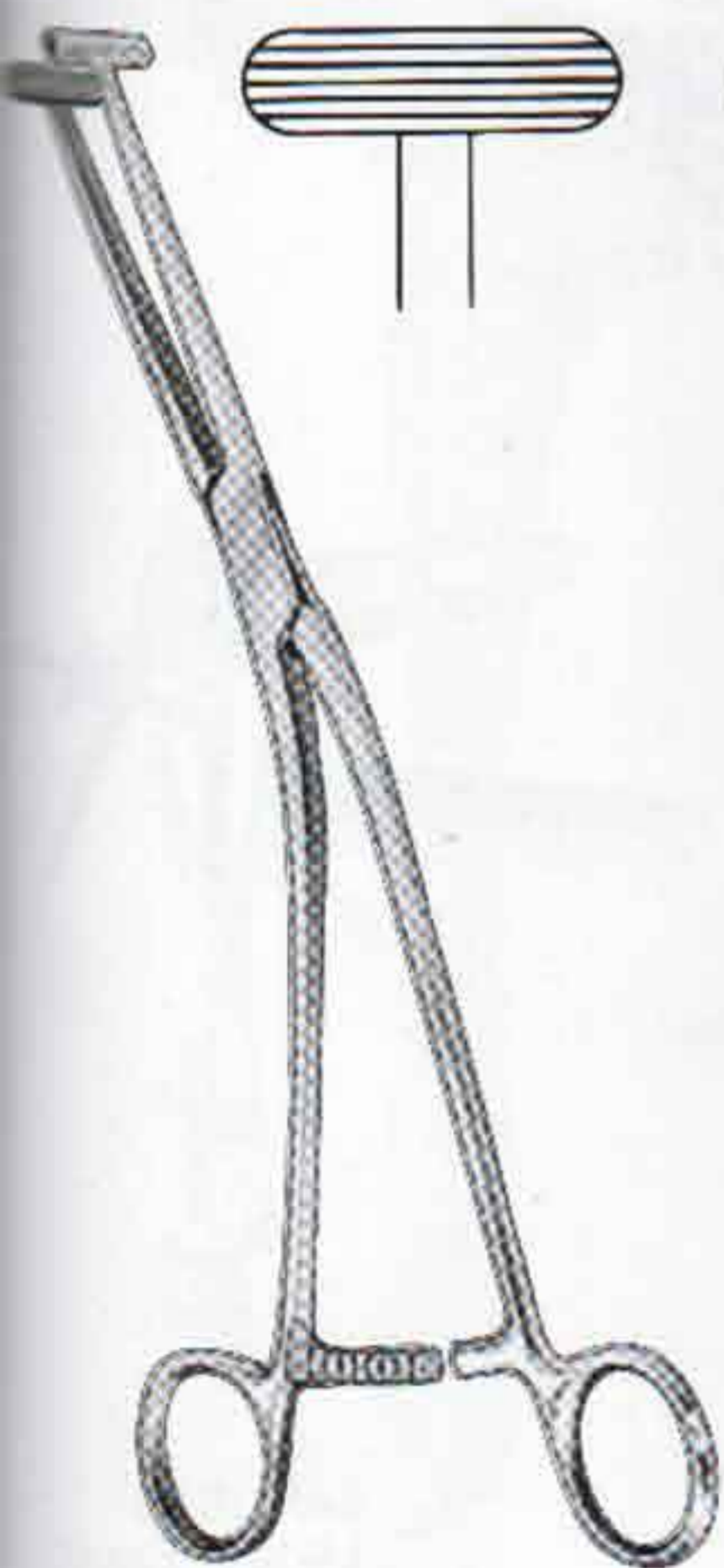

**MILLIN**  
13-900  
23 cm, 9"

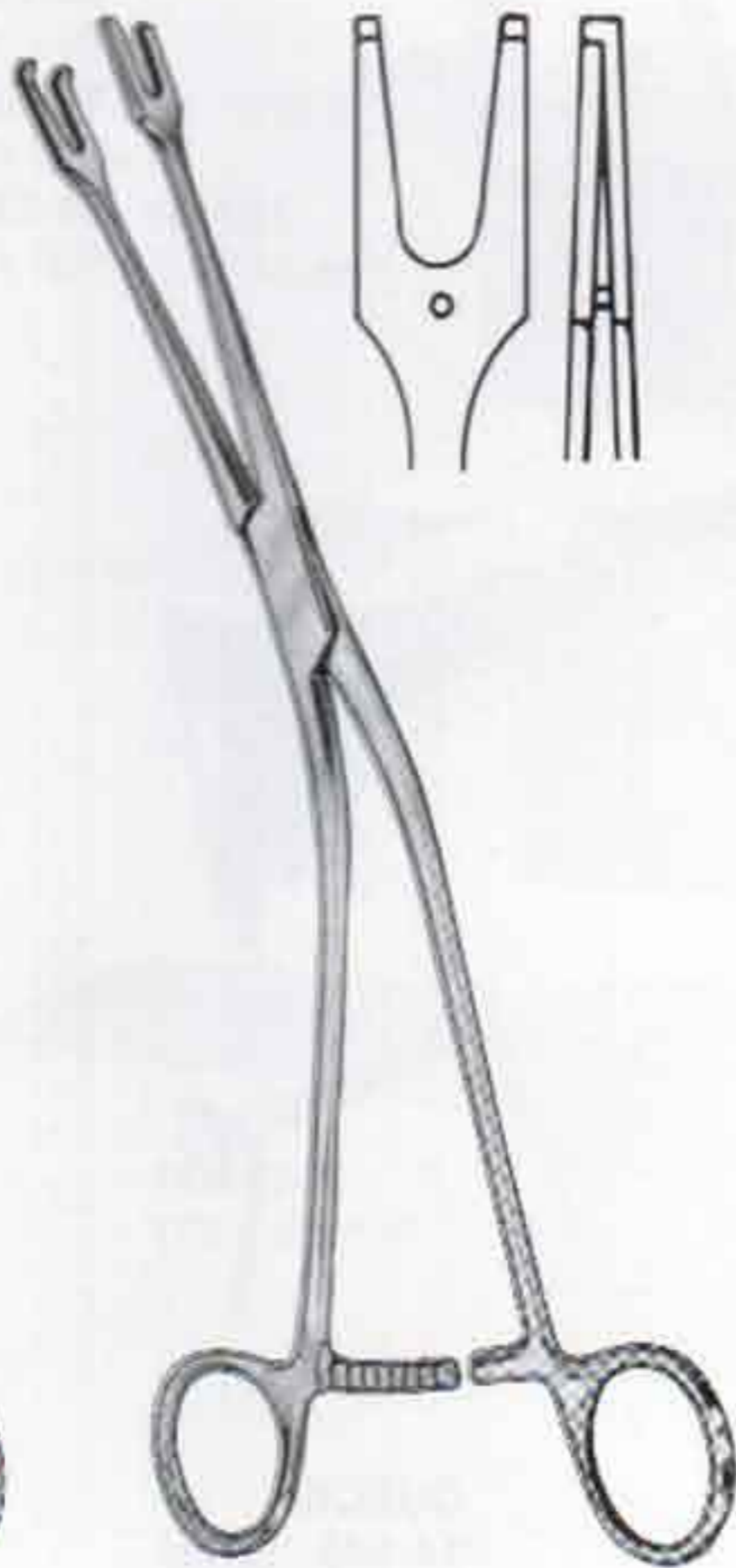

**MILLIN**  
13-910  
23 cm, 9"

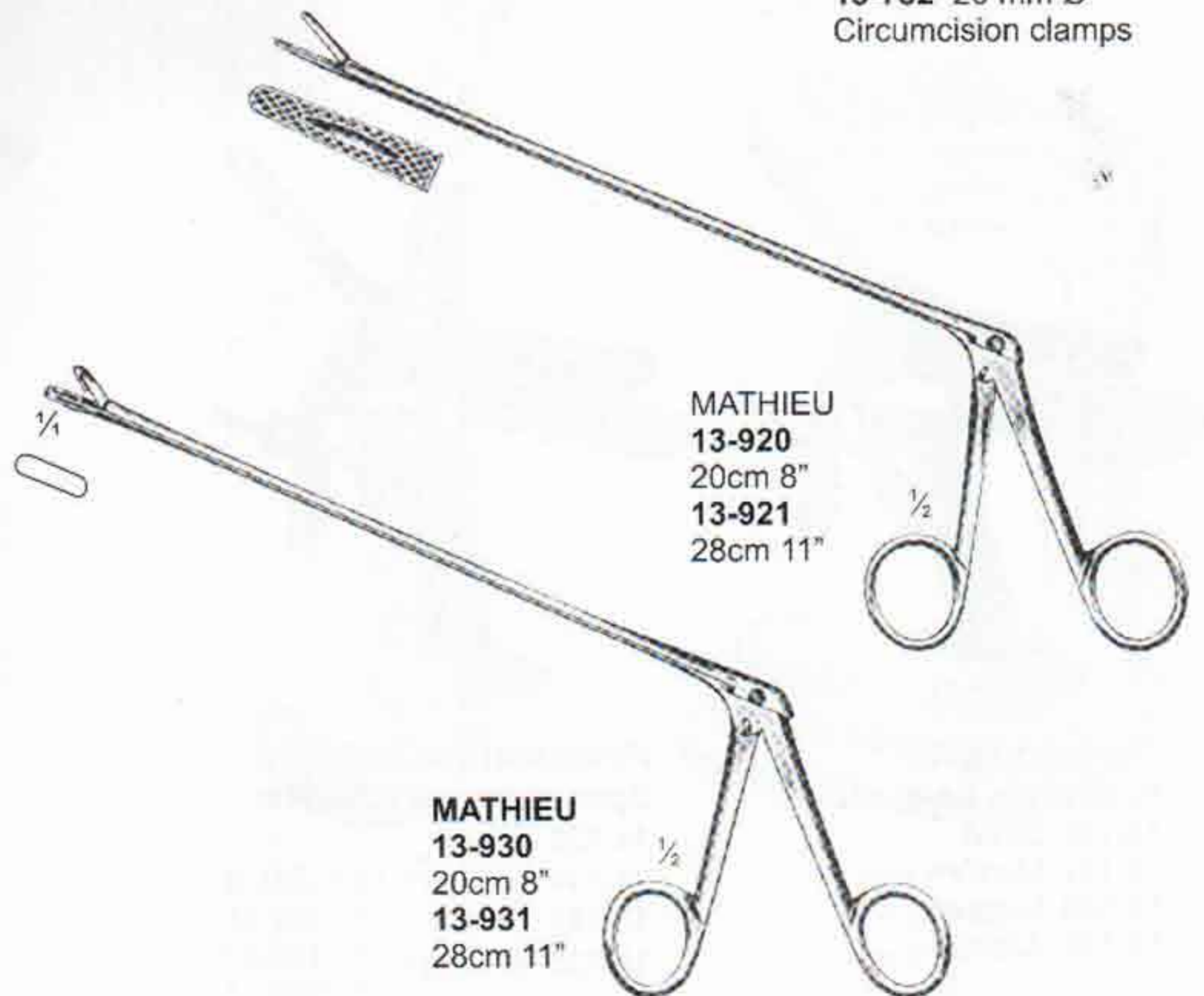

**MATHIEU**  
13-920  
20cm 8"  
13-921  
28cm 11"

**MATHIEU**  
13-930  
20cm 8"  
13-931  
28cm 11"



# VAGINAL SPECULA

Vaginalspekula  
Especulos vaginales

Spéculums vaginaux  
Specoli vaginali



**CUSCO**  
14-100 75 x 32 mm  
14-101 85 x 35 mm  
14-102 100 x 35 mm



**CUSCO**  
14-105 90 x 22 mm  
14-106 100 x 25 mm  
14-107 105 x 27 mm

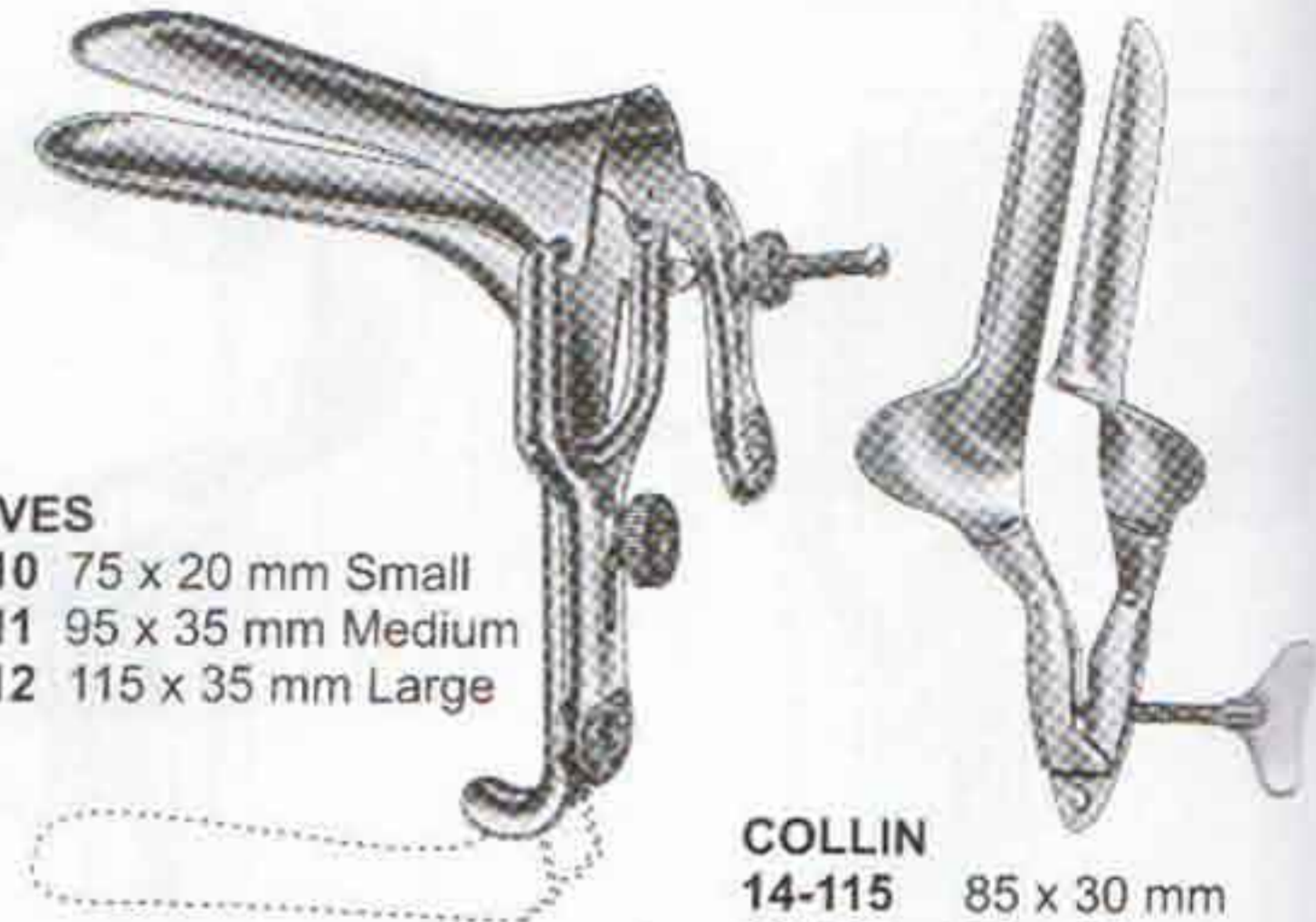

**GRAVES**  
14-110 75 x 20 mm Small  
14-111 95 x 35 mm Medium  
14-112 115 x 35 mm Large

**COLLIN**  
14-115 85 x 30 mm  
14-116 100 x 35 mm  
14-117 110 x 40 mm

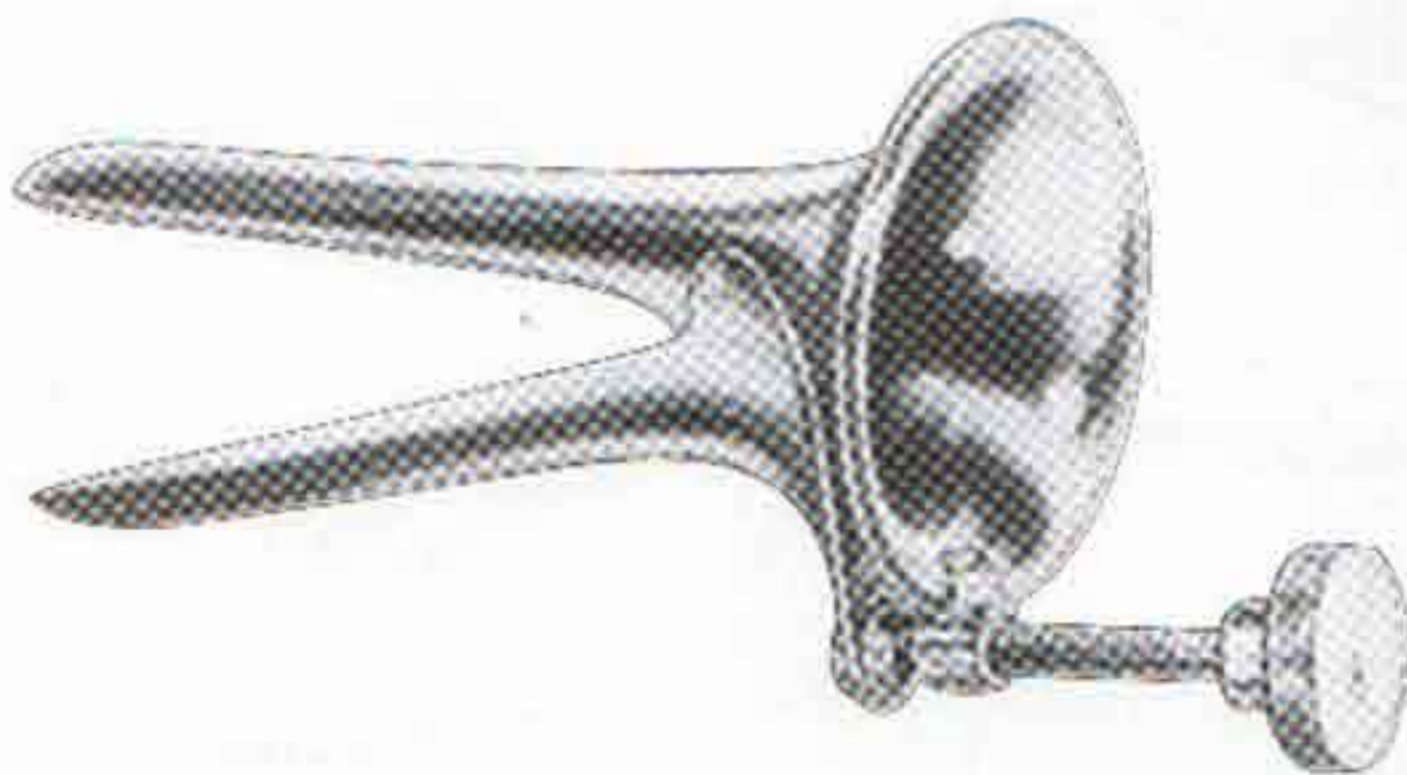

**COLLIN**  
14-120  
55 x 10 mm

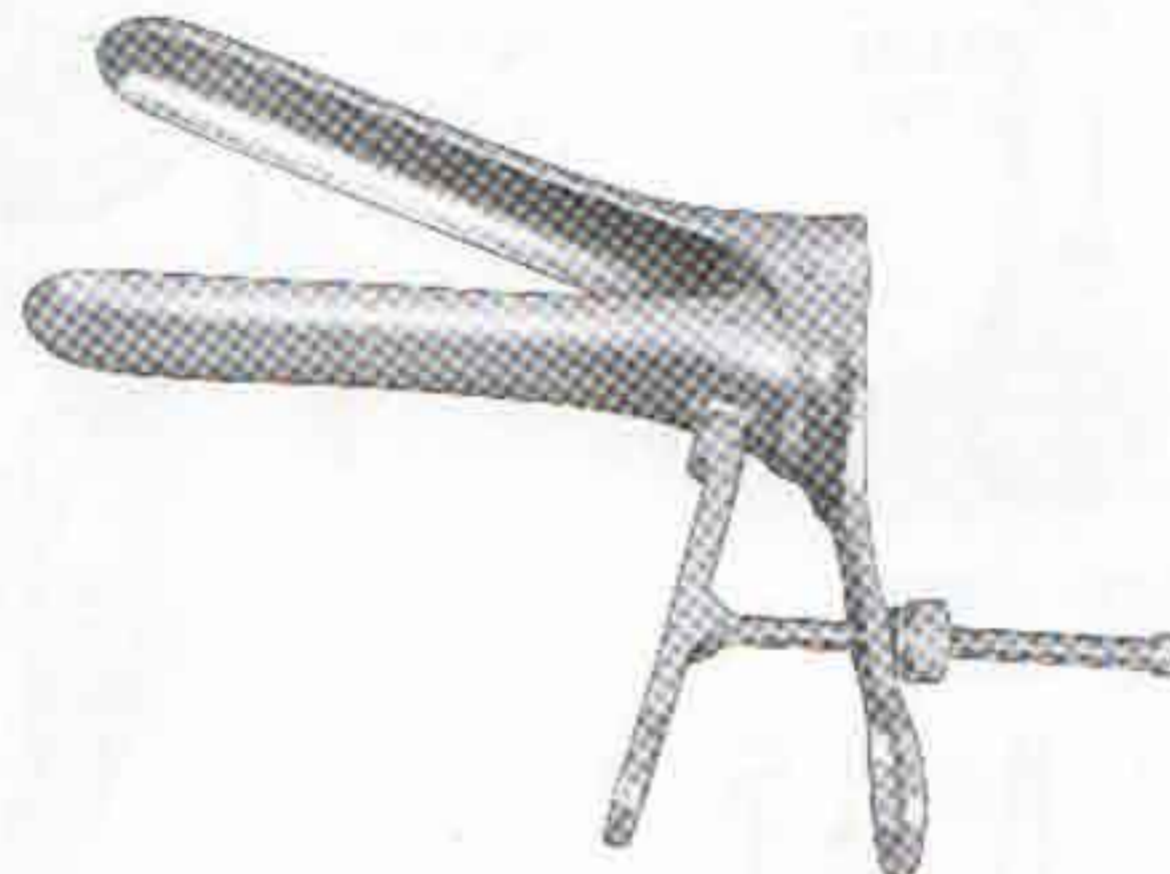

**WINTERTON**  
14-122

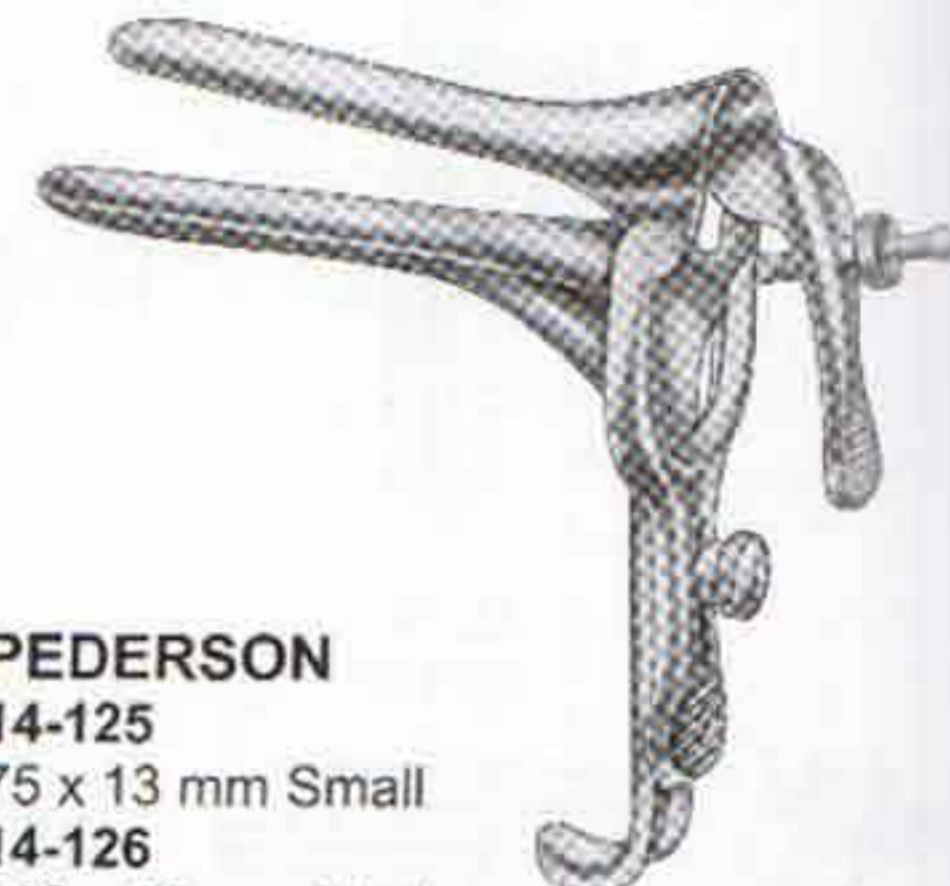

**PEDERSON**  
14-125  
75 x 13 mm Small  
14-126  
100 x 22 mm Medium  
14-127  
120 x 25 mm Large



**Graves Vaginal Speculum Leep / Lietz**  
14-130 Small  
14-131 Medium  
14-132 Large  
14-133 X-large



**Pederson Vaginal Speculum Leep / Lietz**  
14-135 Small  
14-136 Medium  
14-137 Large  
14-138 X-Large

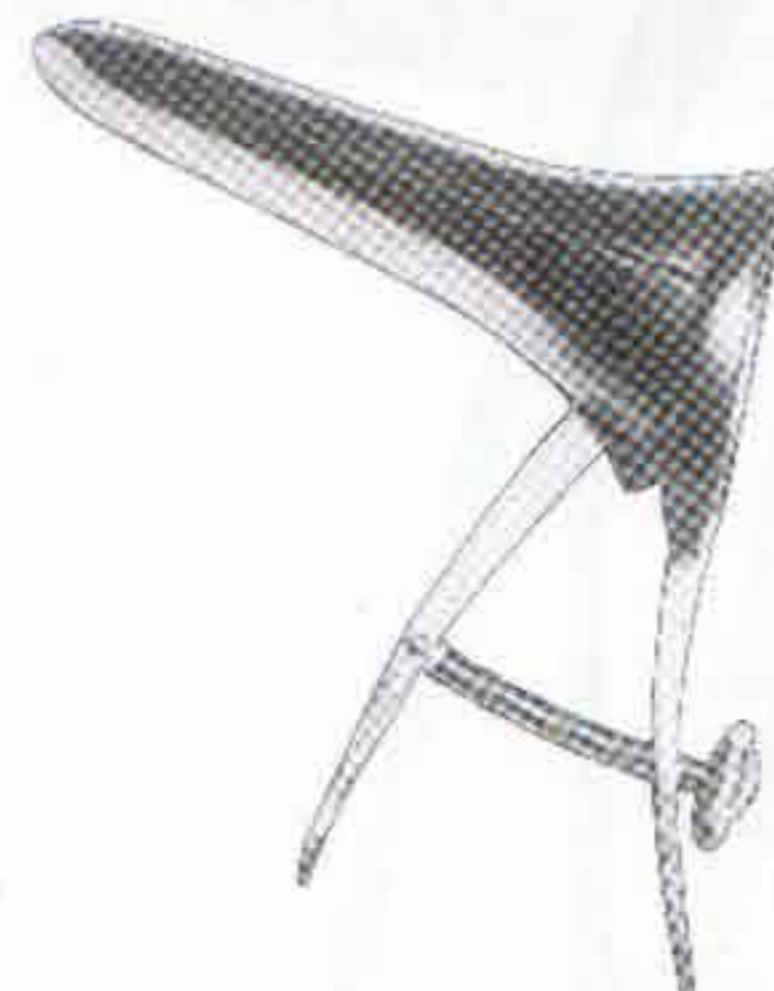

**CUSCO**  
14-140 Small  
14-141 Medium  
14-142 Large



**SAKURAS**  
14-150 Small  
14-151 Medium  
14-152 Large



# VAGINAL SPECULA

Vaginalspekula  
Espéculos vaginales

Spéculums vaginaux  
Specoli vaginali

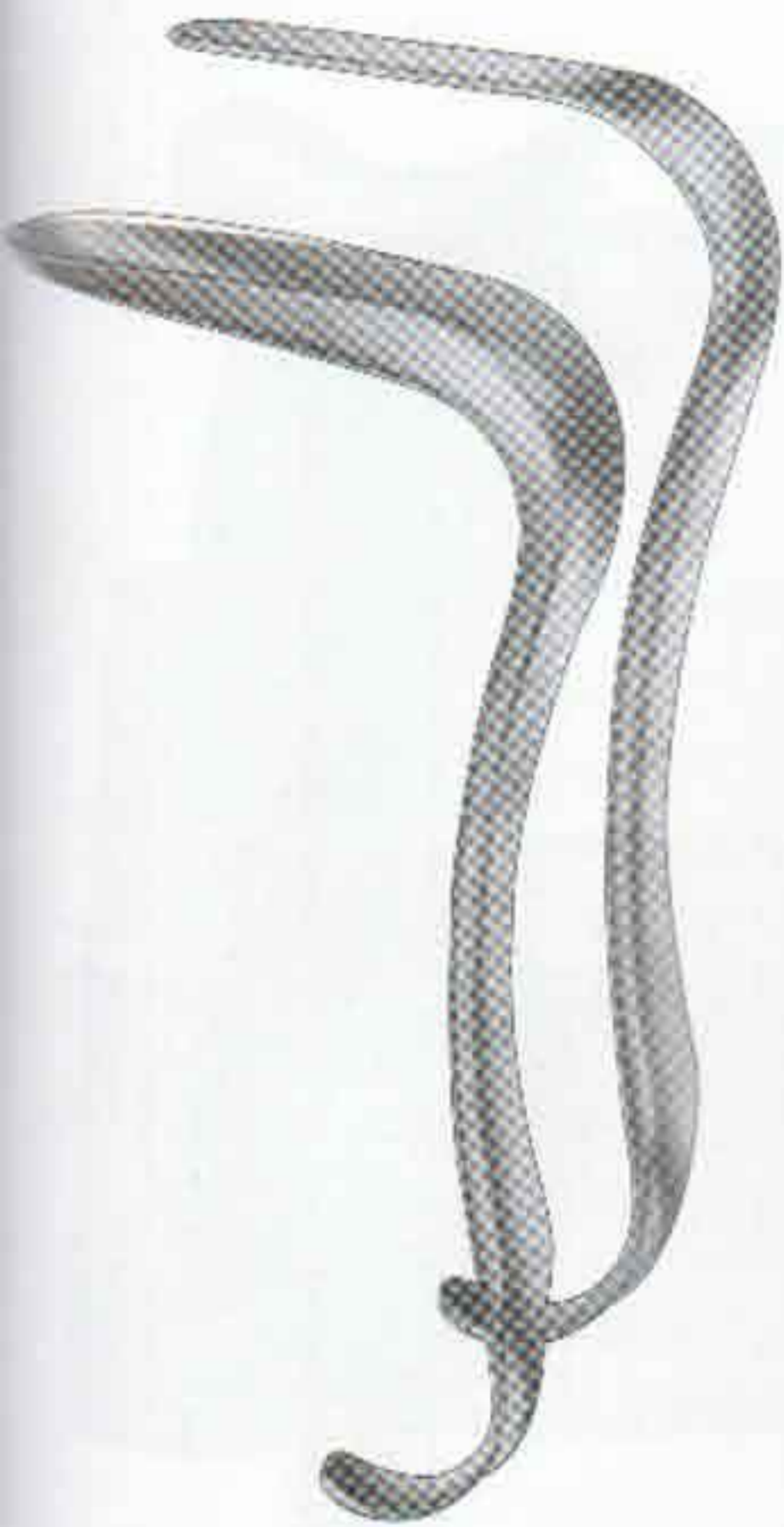

## KRISTELLER

- 14-160 110x18 mm
  - 14-161 110x20 mm
  - 14-162 110x27 mm
  - 14-163 110x30 mm
  - 14-164 110x36 mm
- 22.0 cm,

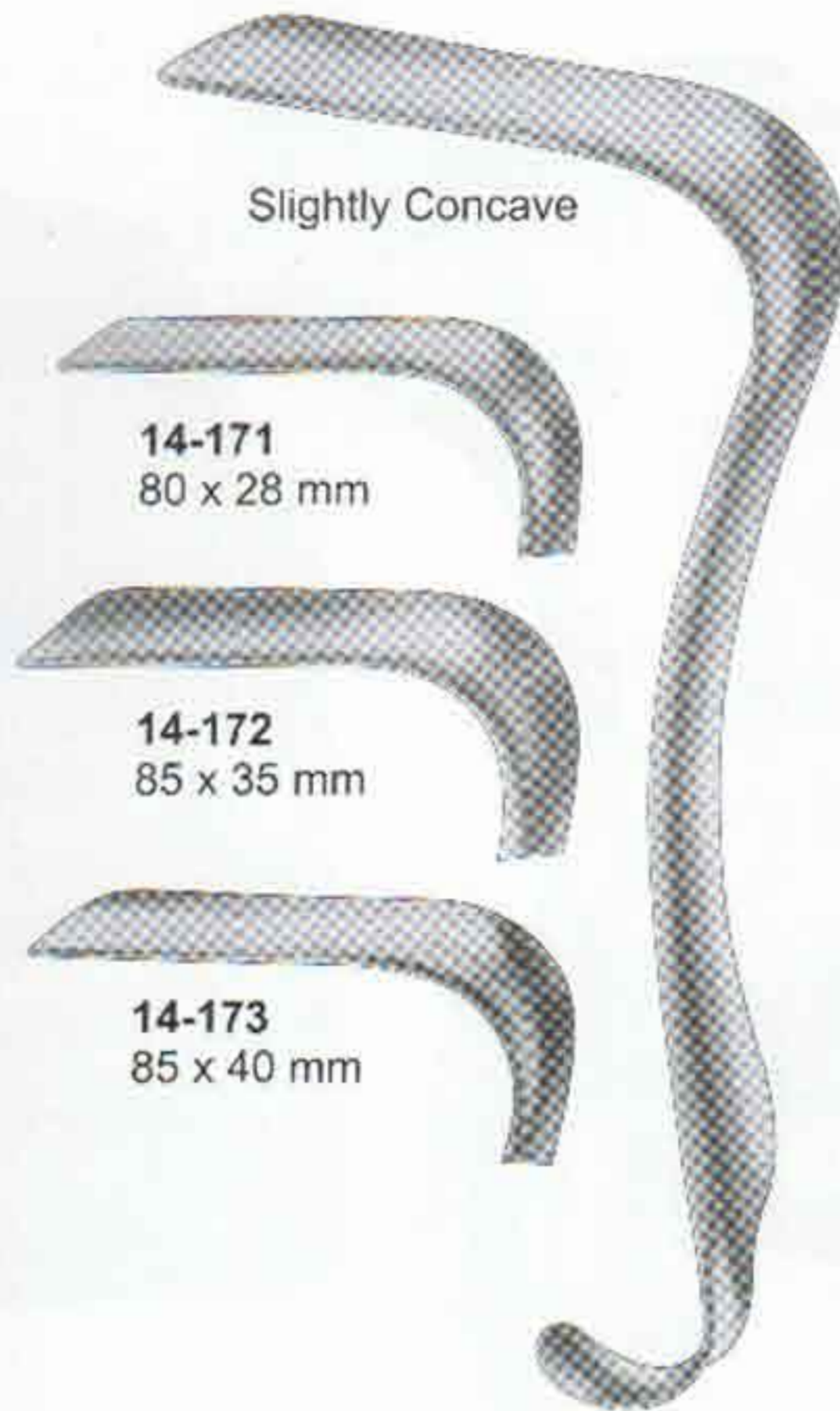

Slightly Concave

14-171  
80 x 28 mm

14-172  
85 x 35 mm

14-173  
85 x 40 mm

## KRISTELLER

14-170  
20.5 cm, 8"

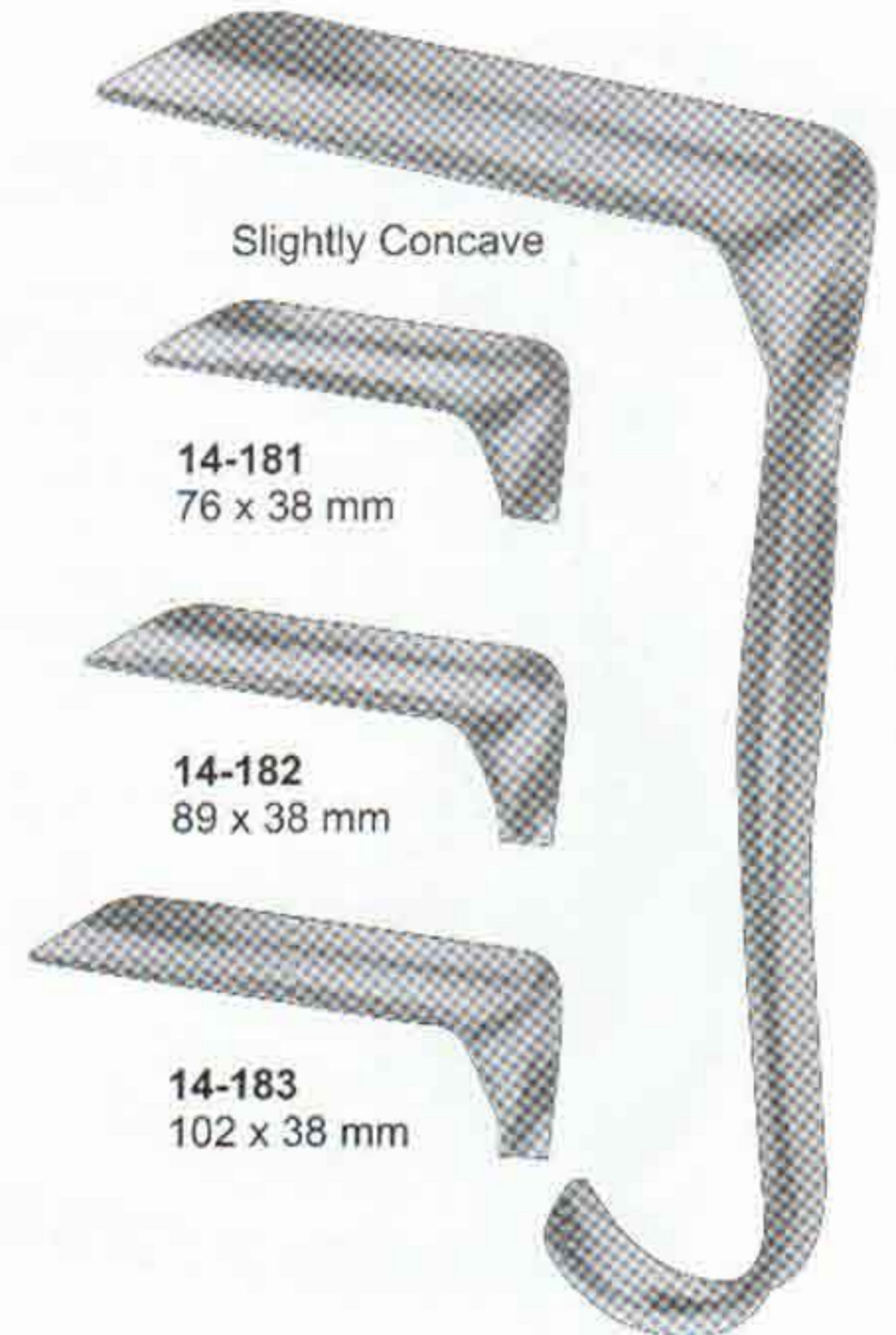

Slightly Concave

14-181  
76 x 38 mm

14-182  
89 x 38 mm

14-183  
102 x 38 mm

## JACKSON

14-180  
17.5 cm, 7"

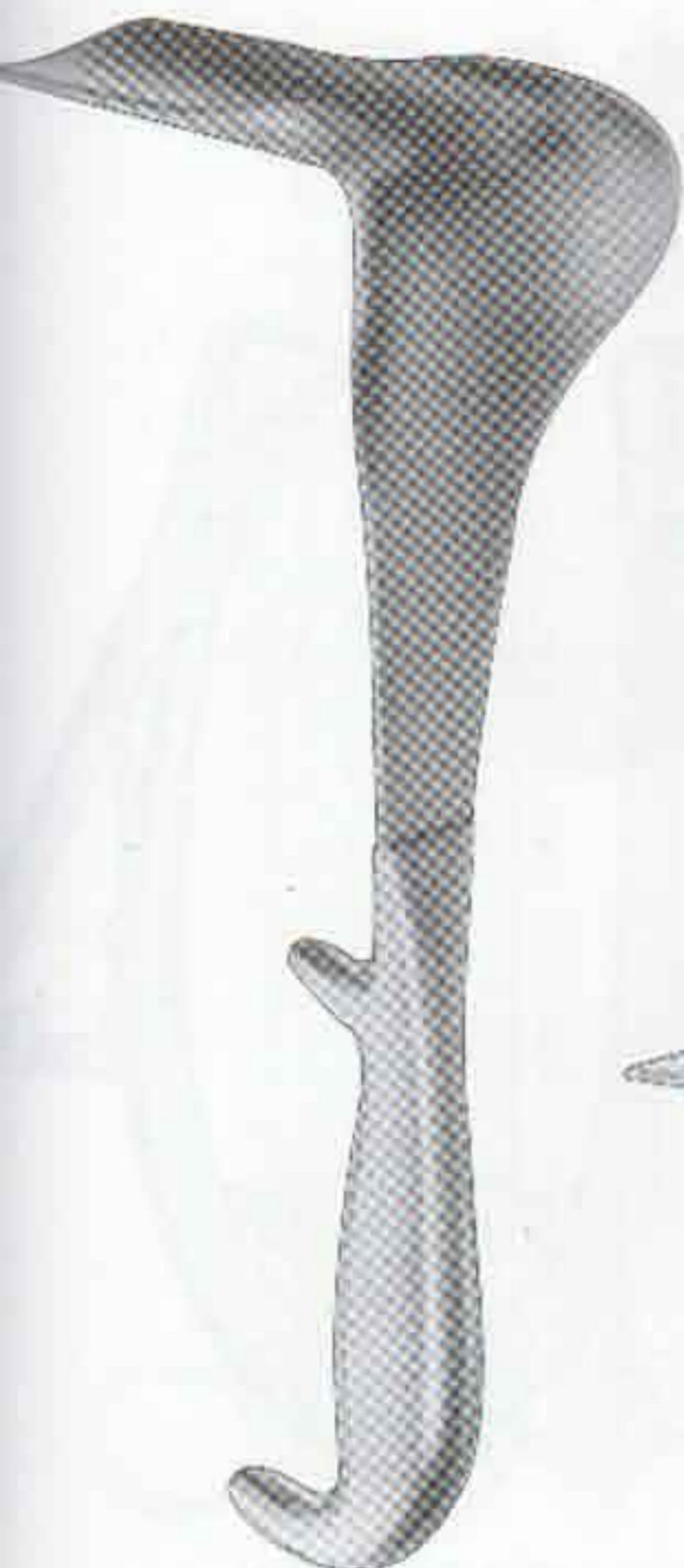

## DOYEN

14-190  
23.5 cm, 9 1/4"

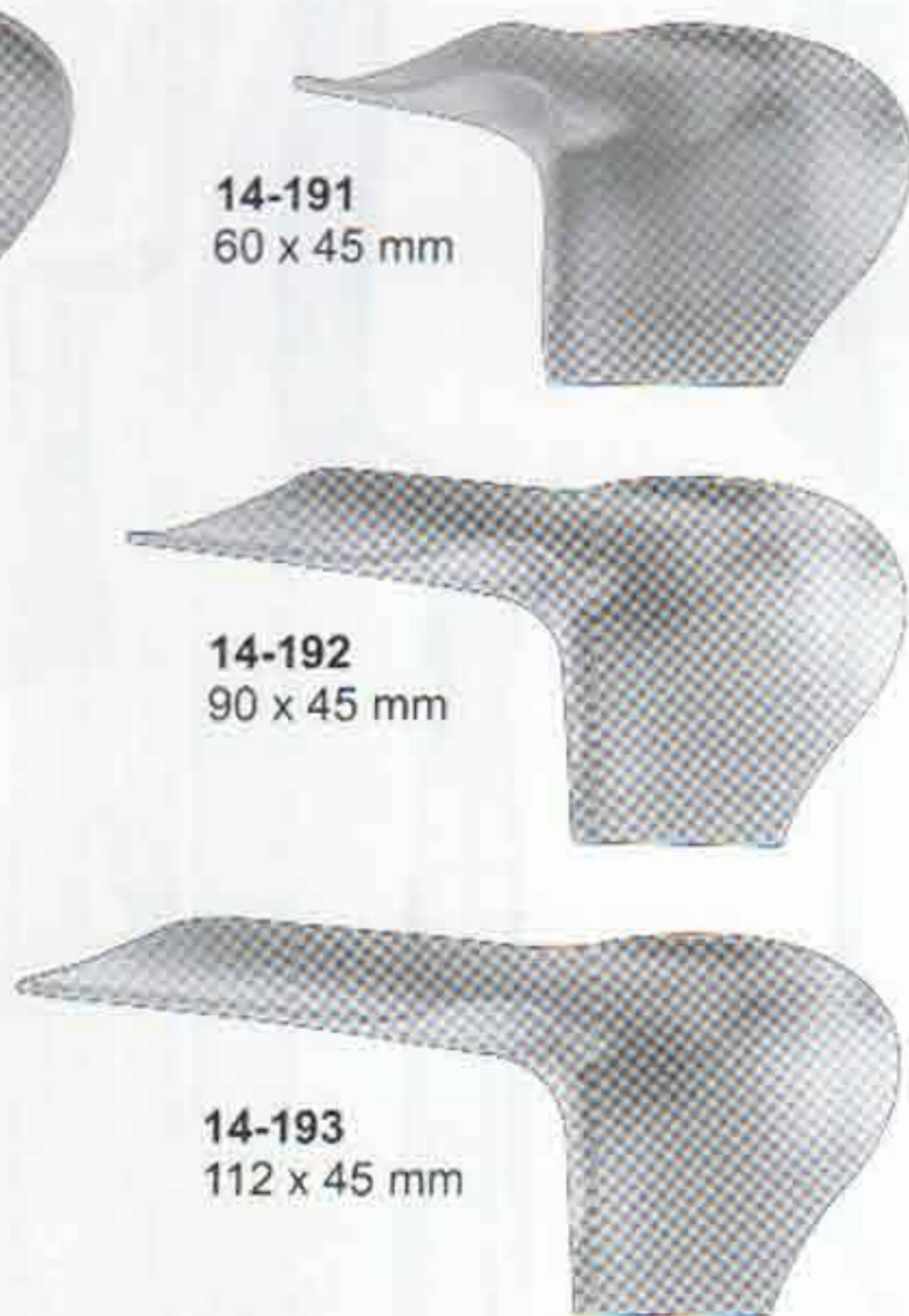

14-191  
60 x 45 mm

14-192  
90 x 45 mm

14-193  
112 x 45 mm

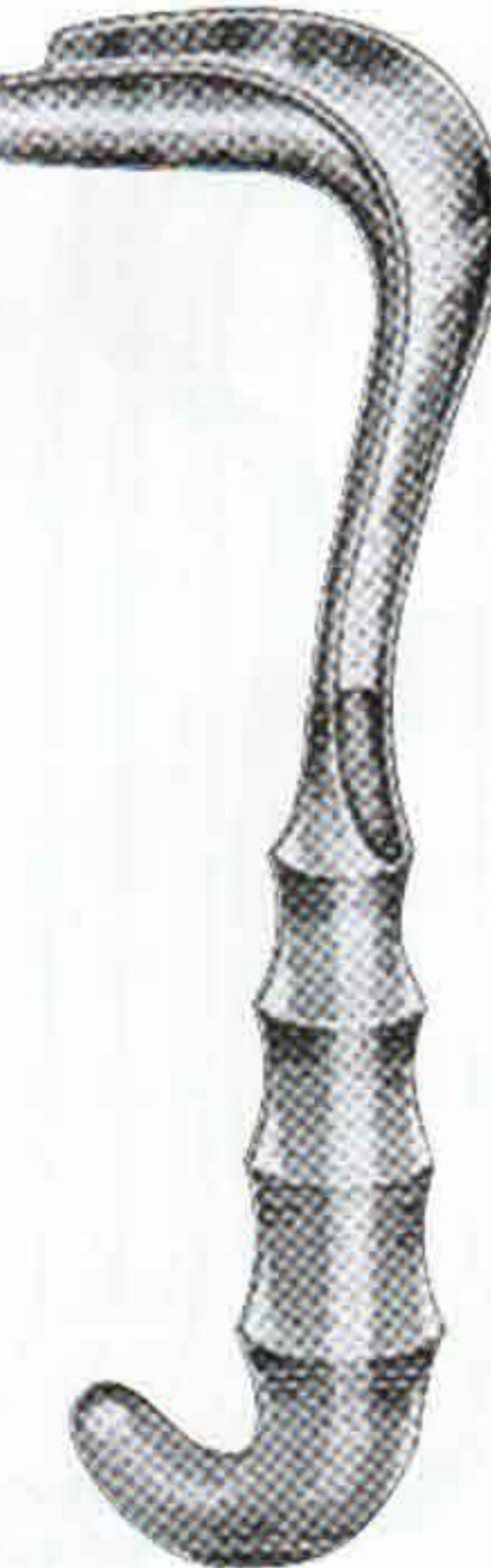

## SIMS-KELLY

14-200 57 x 25 mm  
14-201 69 x 45 mm  
14-202 76 x 38 mm  
24 cm, 9 1/2"

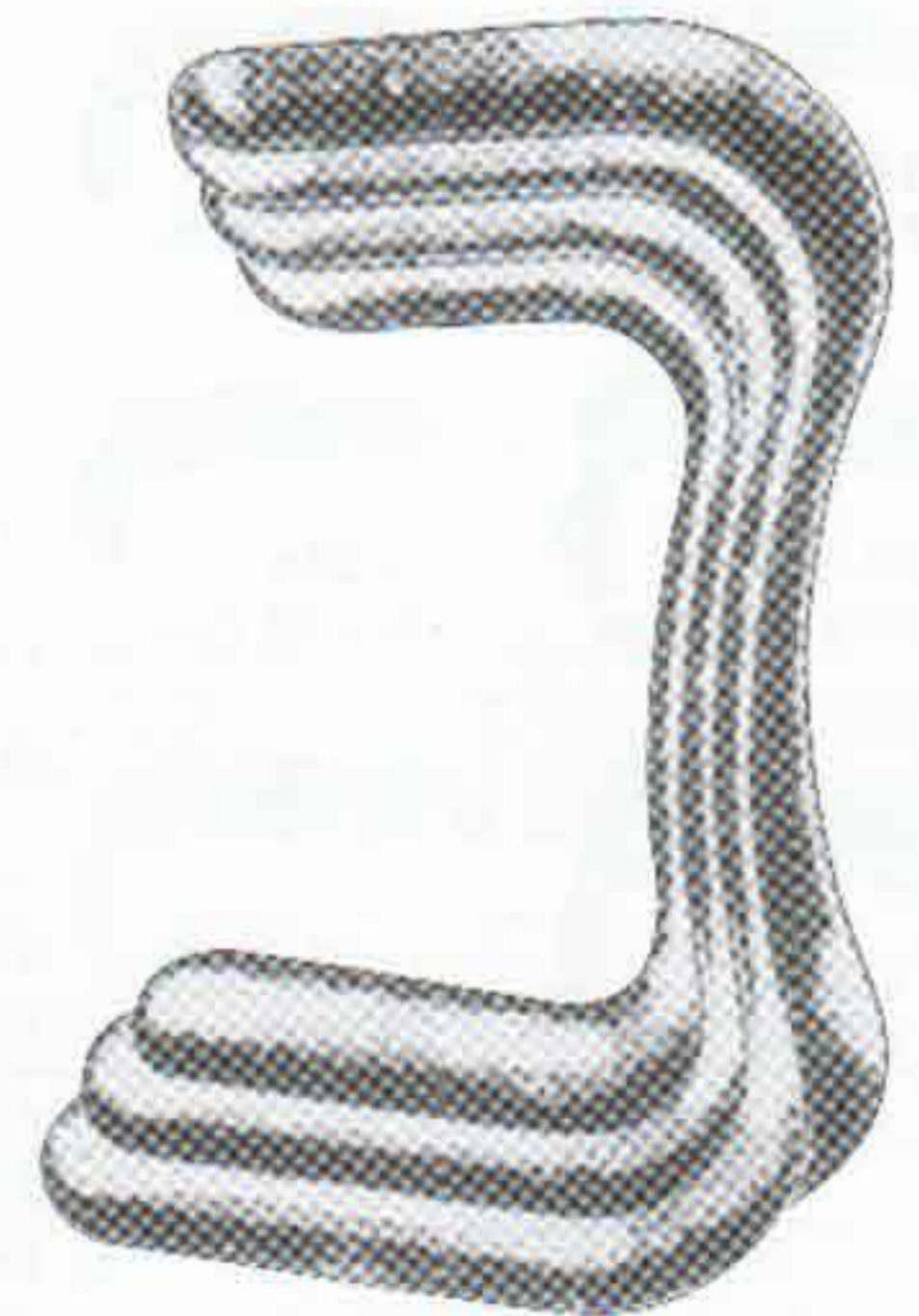

## SIMS

14-210 Small  
14-211 Medium  
14-212 Large



# VAGINAL SPECULA

Vaginalspekula  
Especulos vaginales

Spéculums vaginaux  
Specoli vaginali



**AUVARD**  
14-220  
65 x 38 mm - 28 mm  
1,530 kg  
with fixed weight  
23 cm, 9"



**AUVARD**  
14-230 75 x 42 mm  
(40 mm)  
14-231 105 x 43 mm  
(40 mm)  
with detachable weight  
23 cm, 9"



**AUVARD**  
14-240 2 1/2" Lbs  
14-241 3 Lbs

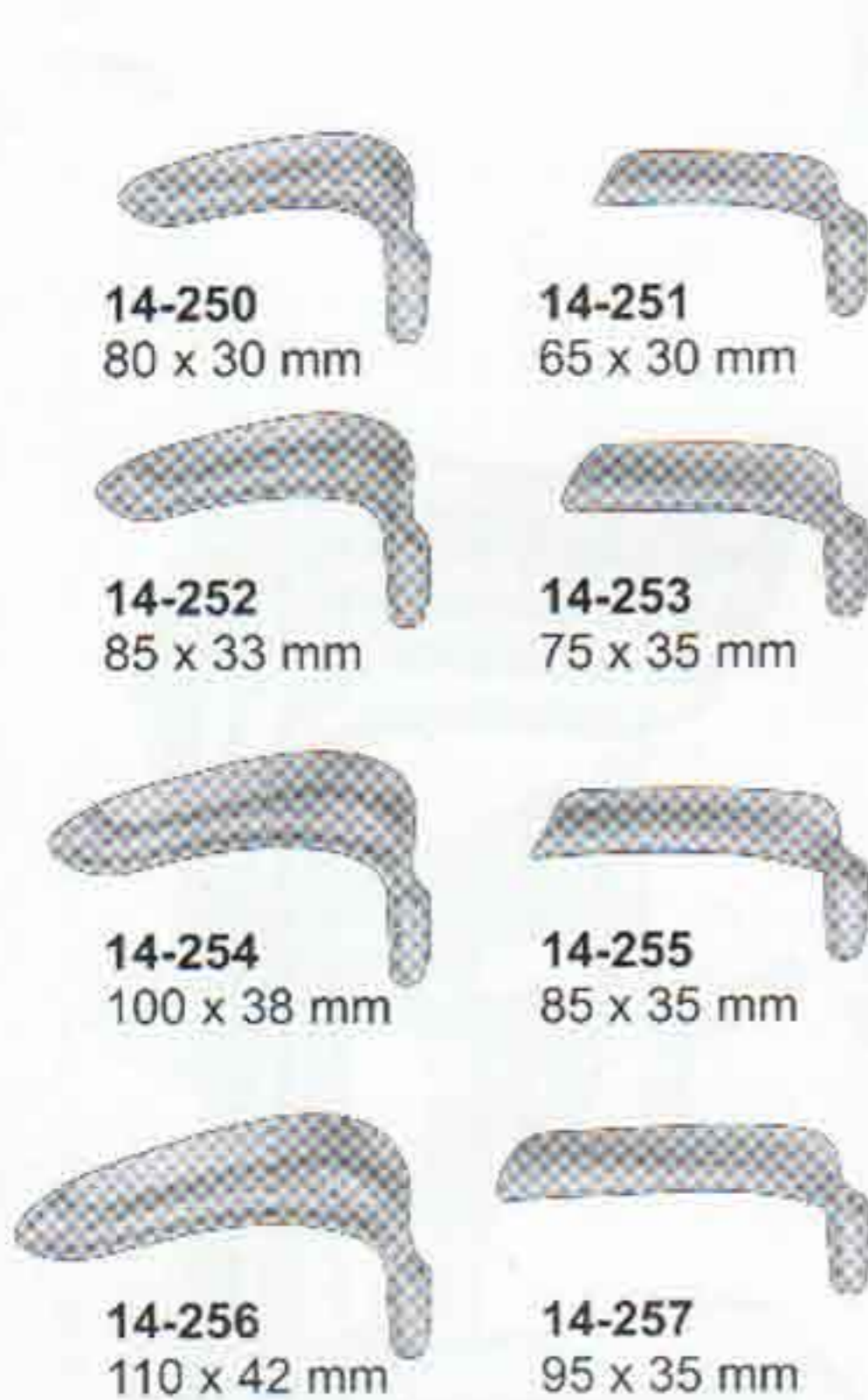

14-250  
80 x 30 mm

14-251  
65 x 30 mm

14-252  
85 x 33 mm

14-253  
75 x 35 mm

14-254  
100 x 38 mm

14-255  
85 x 35 mm

14-256  
110 x 42 mm

14-257  
95 x 35 mm

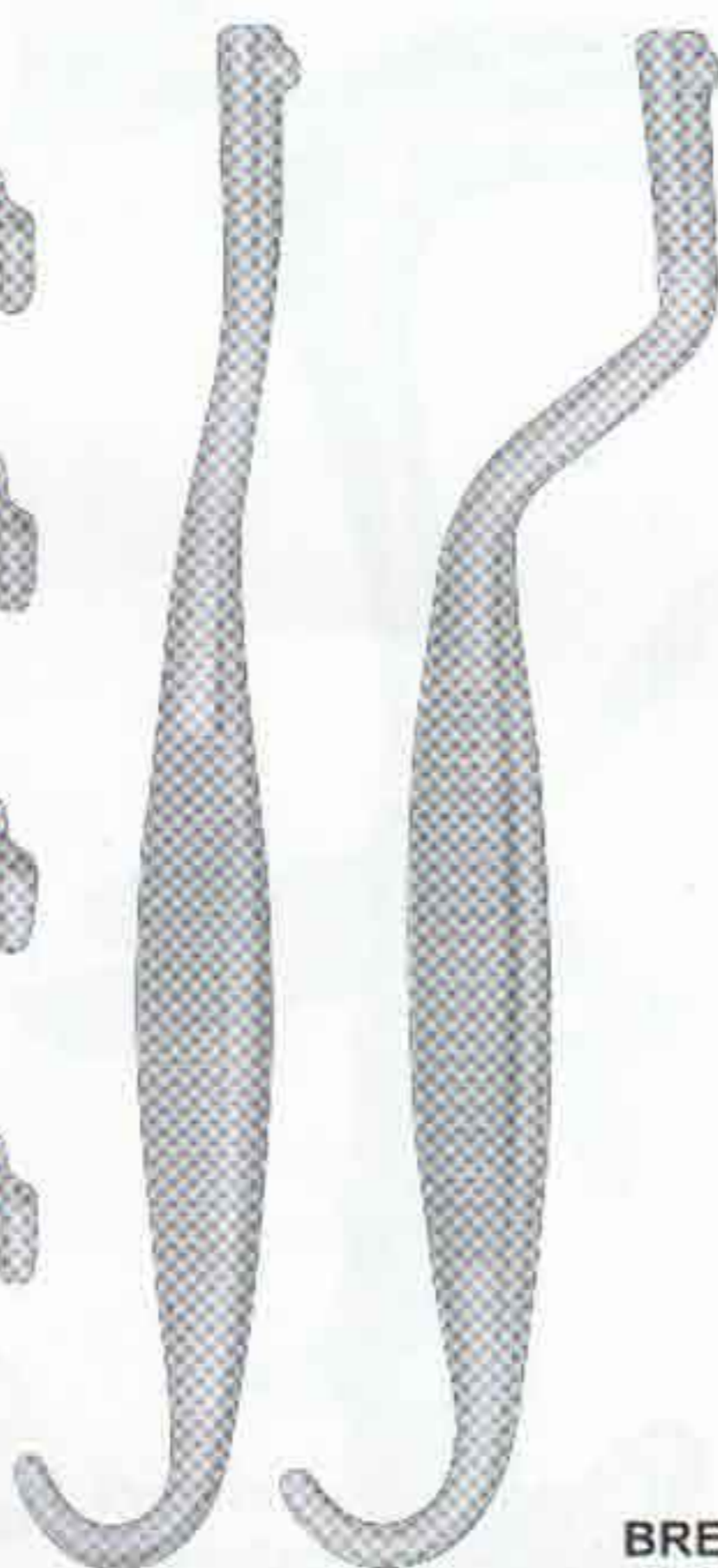

**SCHERBACK**  
14-258  
Set consisting of:  
2 handle  
8 blades



**BREISKY WIENER MODELL/  
VIENNA PATTERN**  
14-270 100 x 20 mm  
14-271 100 x 25 mm  
14-272 100 x 30 mm  
14-273 100 x 35 mm  
14-274 100 x 40 mm  
30 cm, 12"



**LANDAU**  
14-280 105 x 28 mm  
14-281 105 x 38 mm  
30 cm, 12"



**FRIEDMANN**  
14-290  
10 cm, 4"



# UTERINE DILATORS

Uterusdilatatoren  
Dilatadores uterinos

Dilatateurs du col de l'utérus  
Dilatatori uterini



**PRATT GYNE**  
**14-300**  
Set of 8 Double ended  
size 13/14 thru 41/43  
4.5/5.0mm thru 13.6/14.3mm



**14-310** Set of 14 dilators  
(4.0 - 17.0 mm), in leather pouch  
with removable, washable canvas  
lining, with zip fastener

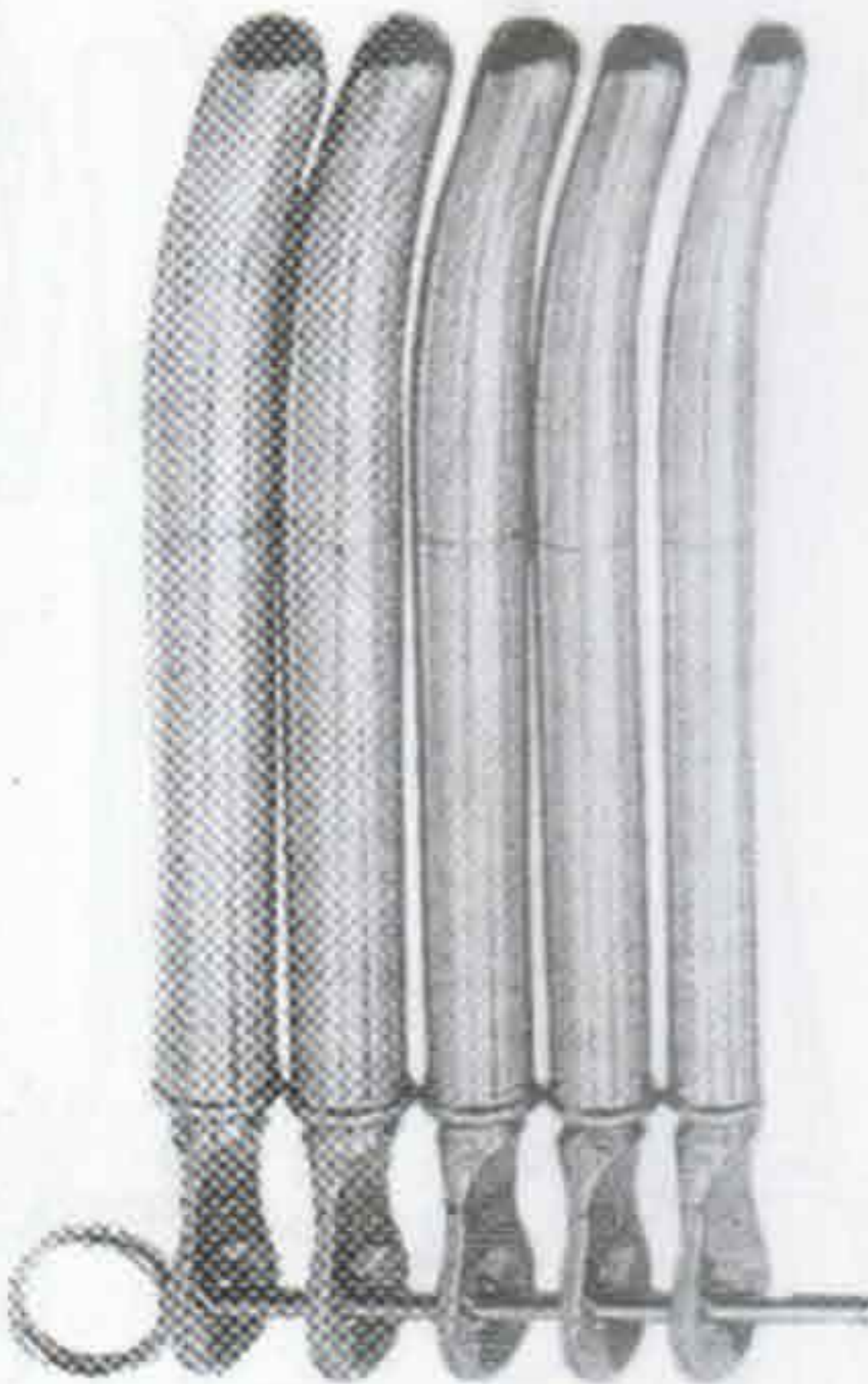

**DILATORS SET**  
**14-320**  
Set of 5 dilators

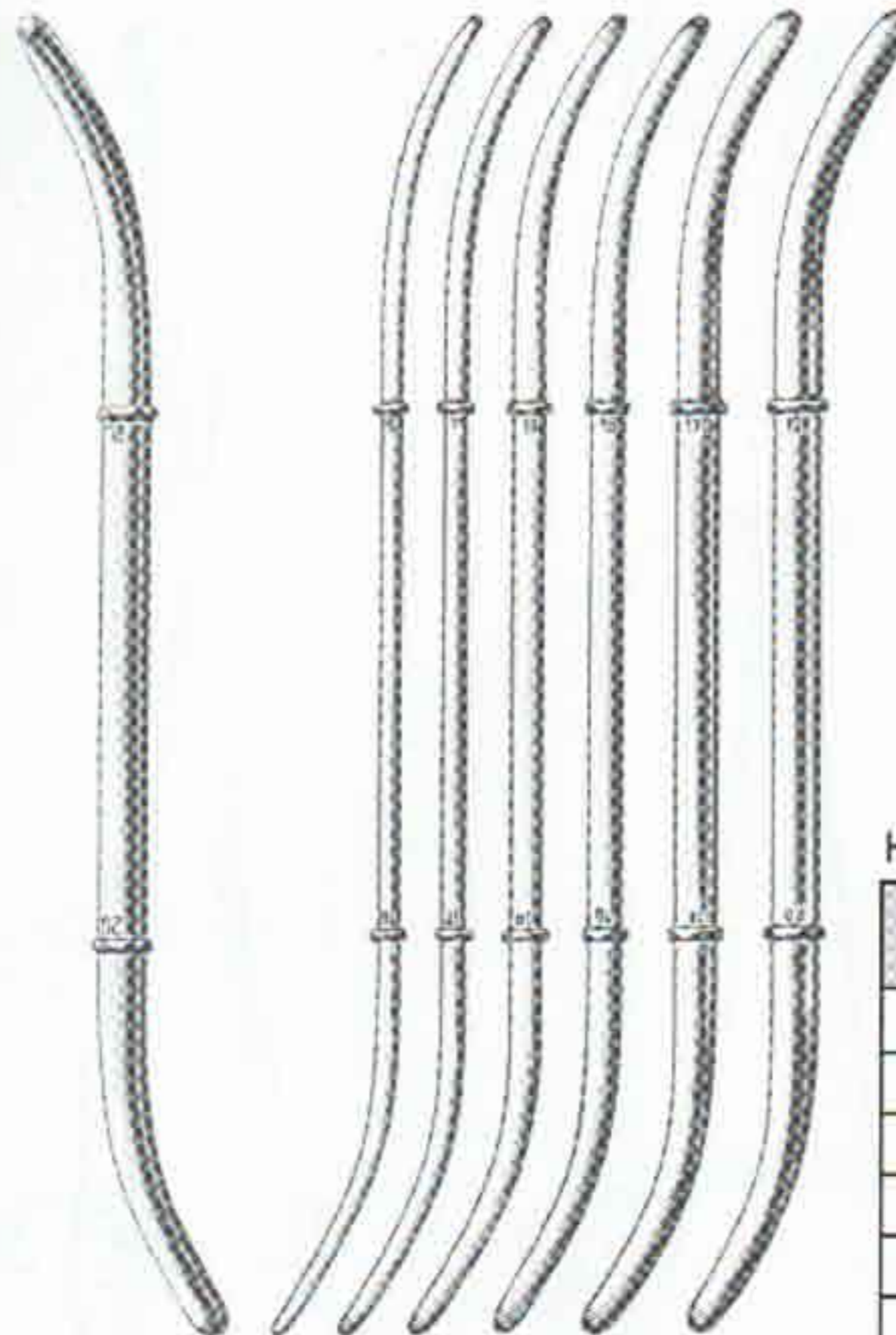

Hank with conical point double ended

Fig.	mmØ	Hank
9/10	4.5/5	14-330
11/12	5.56	14-331
13/14	6.5/7	14-332
15/16	7.5/8	14-333
17/18	8.5/9	14-334
19/20	9.5/10	14-335



# UTERINE DILATORS, UTERINE SOUNDS

Uterusdilatoren, Uterussonden  
Dilatadores uterinos, Histerómetros

Dilatateurs du col de l'utérus, Hystéromètres  
Dilatatori uterini, Isterometri

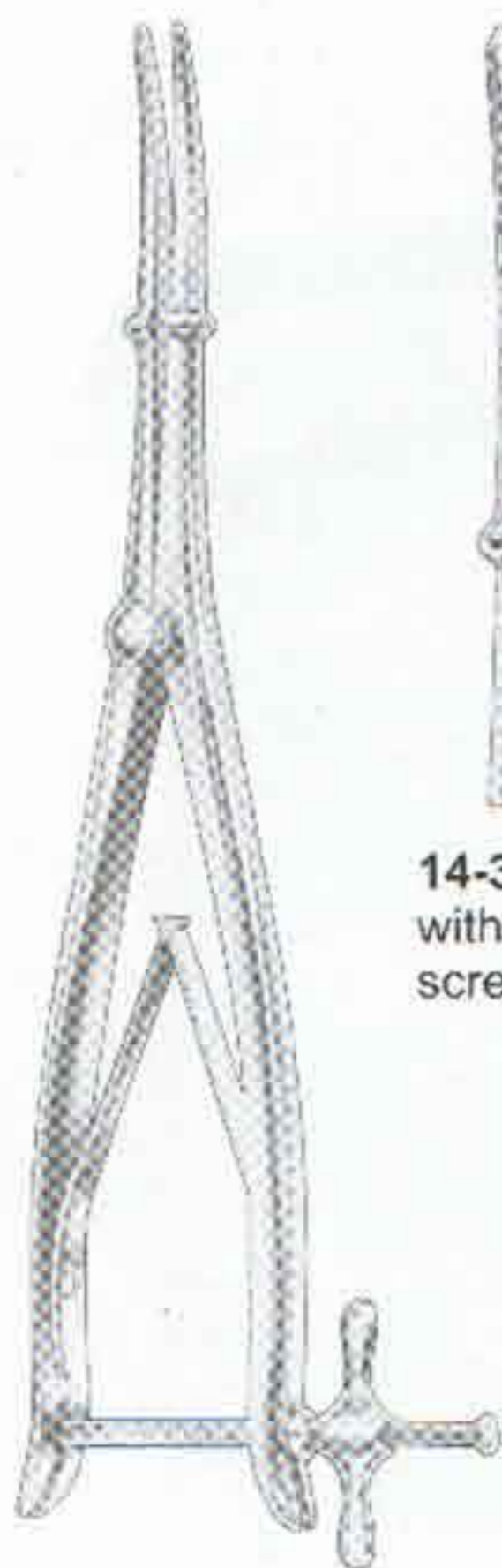

**WYLIE**  
14-340  
29cm 11 1/2"  
with graduated fixing  
screw, smooth jaws



**14-341**  
with graduated fixing  
screw, smooth jaws

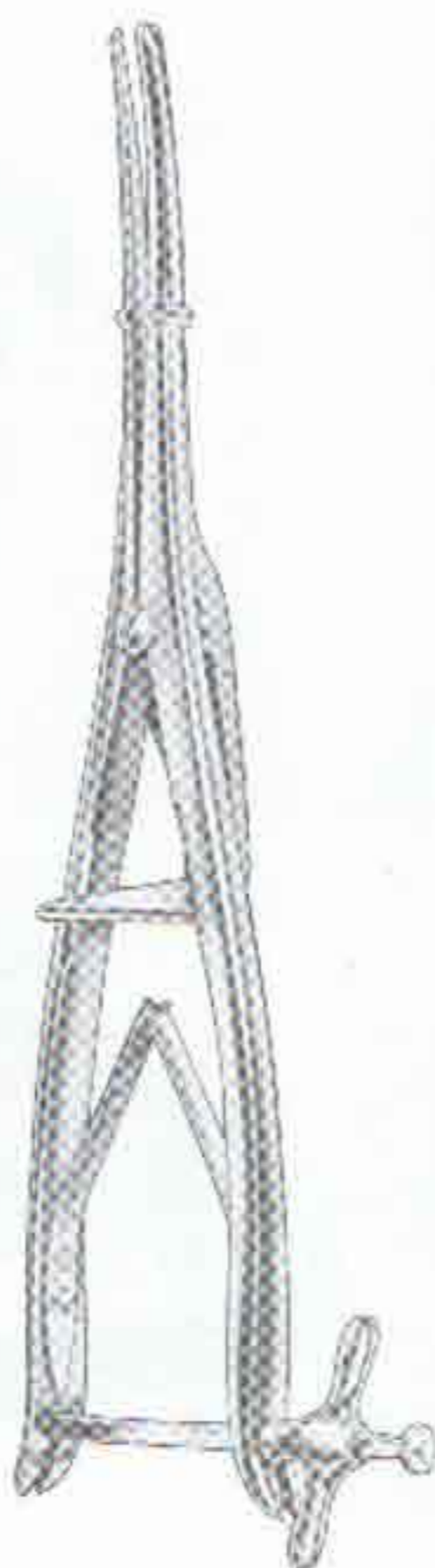

**SIMS**  
14-350  
29cm 11 1/2"  
with fixing screw,  
three-bladed, smooth jaws

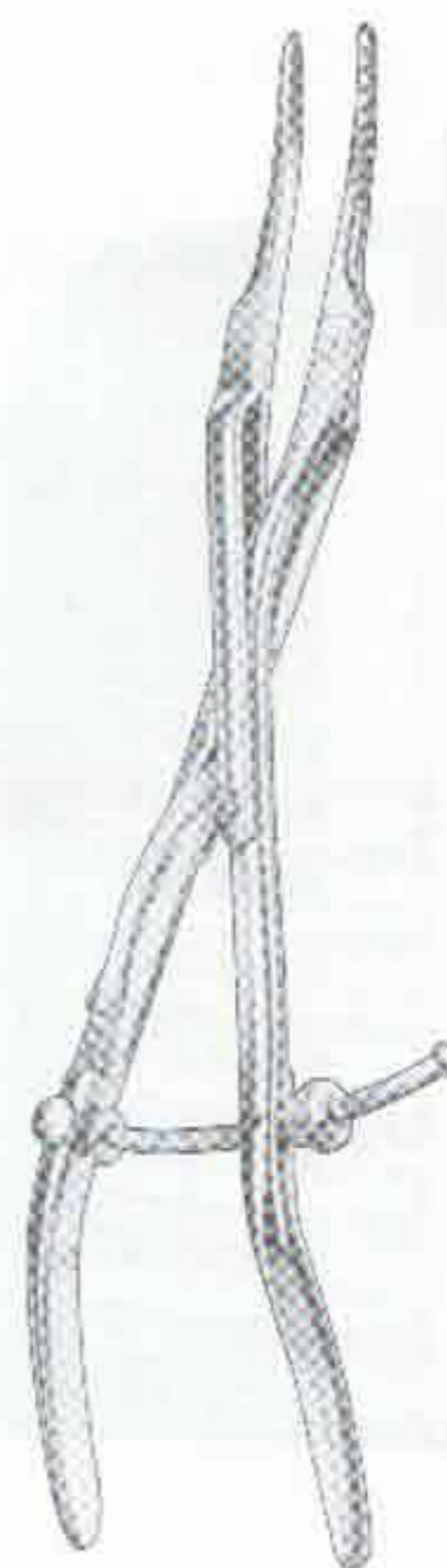

**GOODELL**  
14-360  
29cm 11 1/2"  
with graduated fixing  
screw, serrated jaws



**SIMS UTERINE  
CURETTE**  
14-370  
double ended, sharp  
as above but blunt  
25 cm, 10"  
small, medium, large



**SIMS**  
schwed. Modell  
14-380  
26 cm, 10 1/4"



**MARTIN**  
14-390  
30 cm, 12"



**VALLEIX**  
14-400  
25 cm, 10"



**GALABIN**  
14-410  
32 cm, 12 1/4"



**HORROCKS  
UTERINE SOUND**  
14-420  
32 cm, 12 1/4"

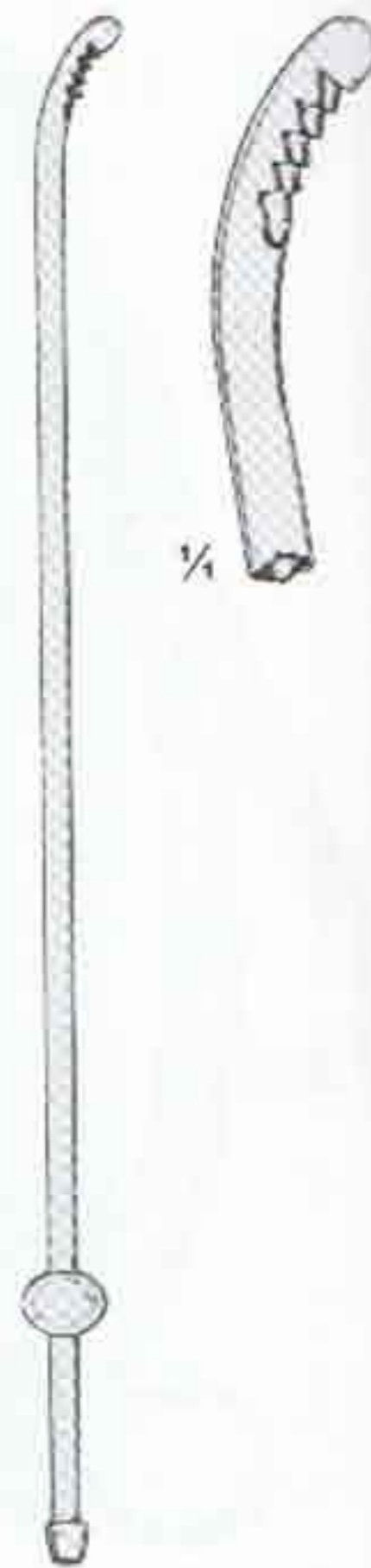

**NOVAK " SUCTION  
CANNULA CURETTE"**  
14-430  
Luer cone,  
25.4 cm, 10"



# UTERINE TENACULUM FORCEPS

Hakenzangen, amniotom  
Pinza para cuello uterino, amniótomo

Pince pour le col de l'utérus, amniotome  
Pinza per il collo dell'utero, amniotomo

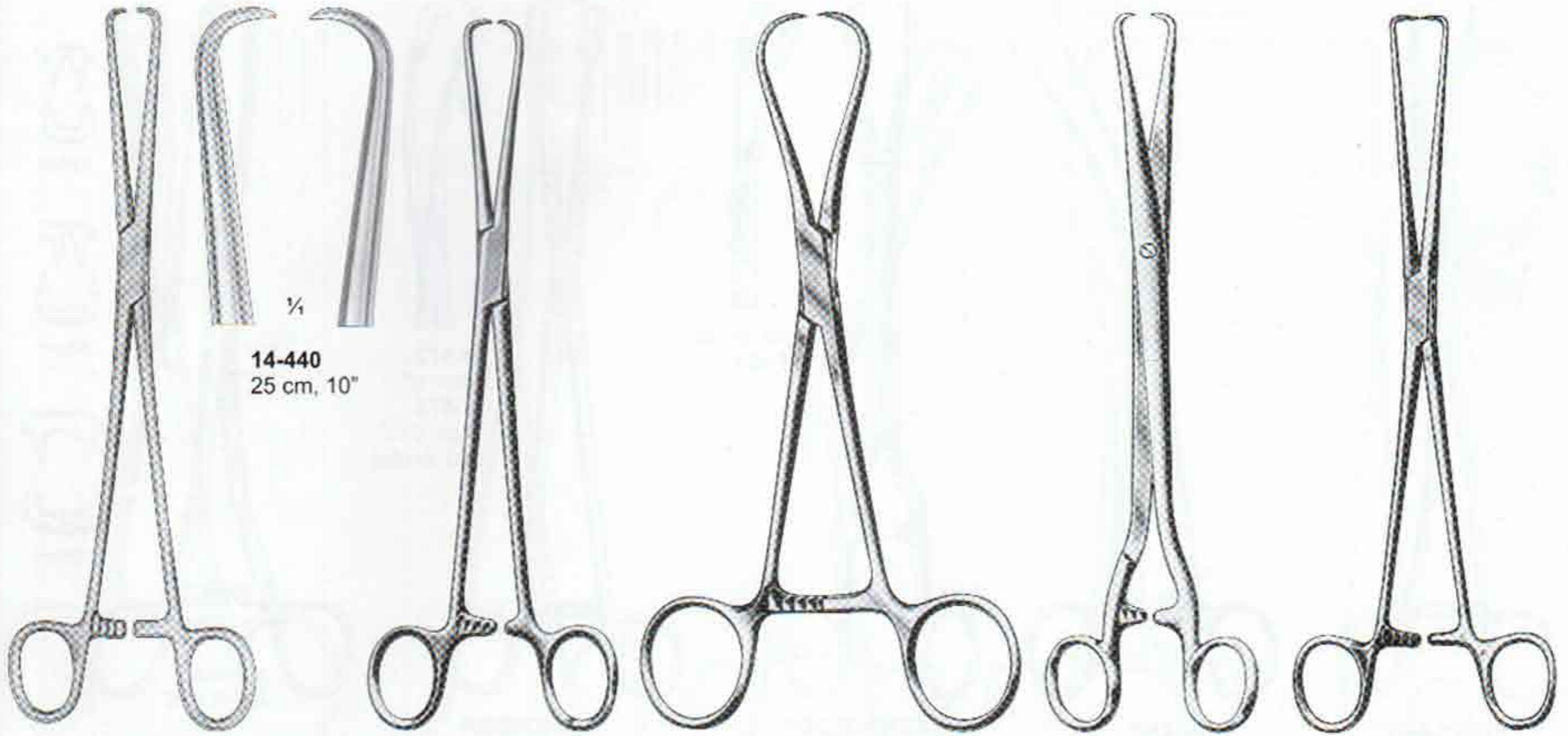

**SCHRÖDER**

**14-440**  
25 cm, 10"

**SCHRÖDER**  
14-450  
25cm 10"

**STAUDE-MOORE**  
14-460  
17cm 6 3/4"

**SCHROEDER**  
14-470  
25cm 10"

**BRAUN**  
14-480  
25cm 10"

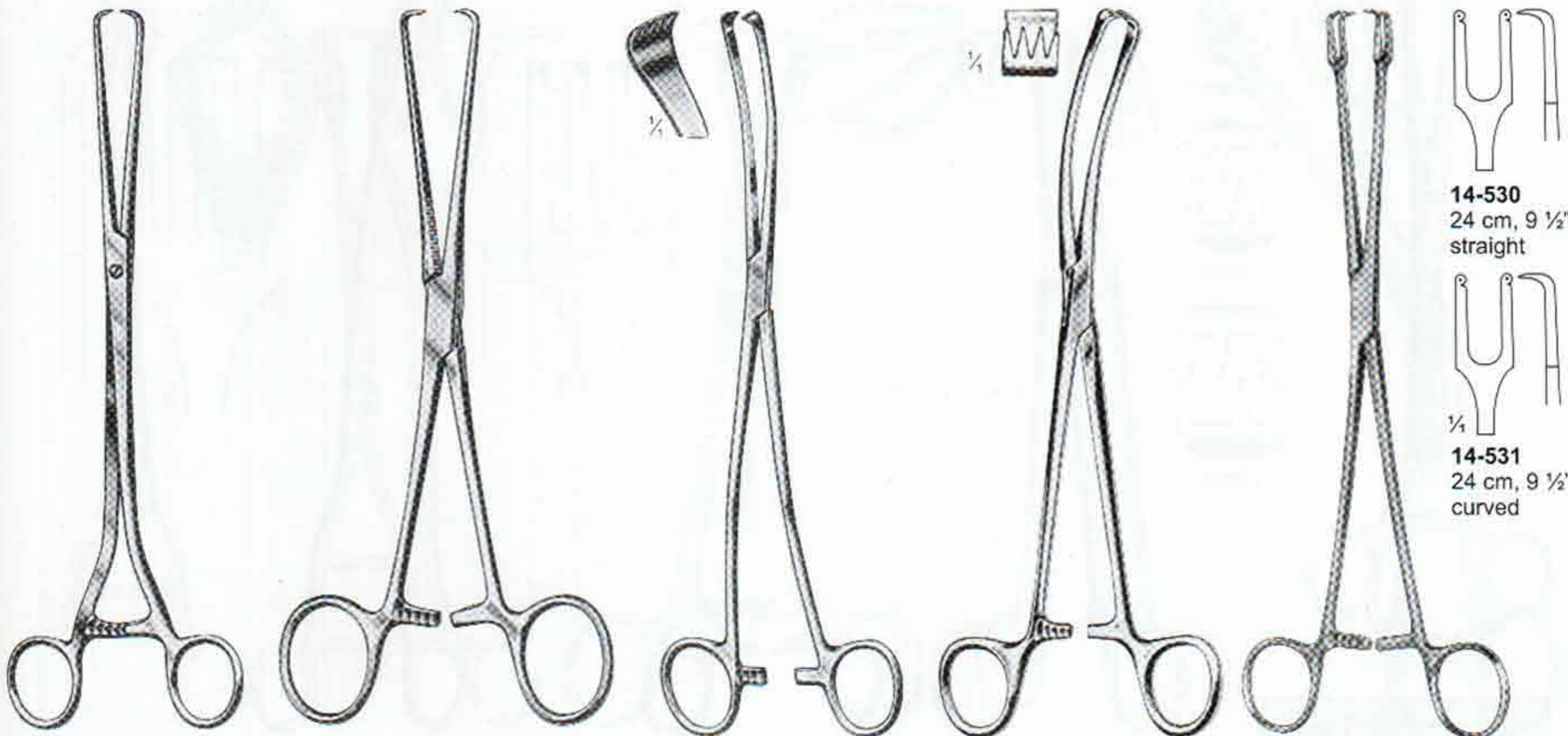

**POZZI**  
14-490  
25cm 10"

**BARRETT**  
14-500  
18cm 7"

**LOWA**  
14-510  
26cm 10 1/4"

**TEALE**  
14-520  
23cm 9"

**SCHRÖDER GYNE**

**14-530**  
24 cm, 9 1/2"  
straight

**14-531**  
24 cm, 9 1/2"  
curved



# UTERINE TENACULUM FORCEPS

Hakenzangen, amniotom  
Pinza para cuello uterino, amniótomo

Pince pour le col de l'utérus, amniotome  
Pinza per il collo dell'utero, amniotomo

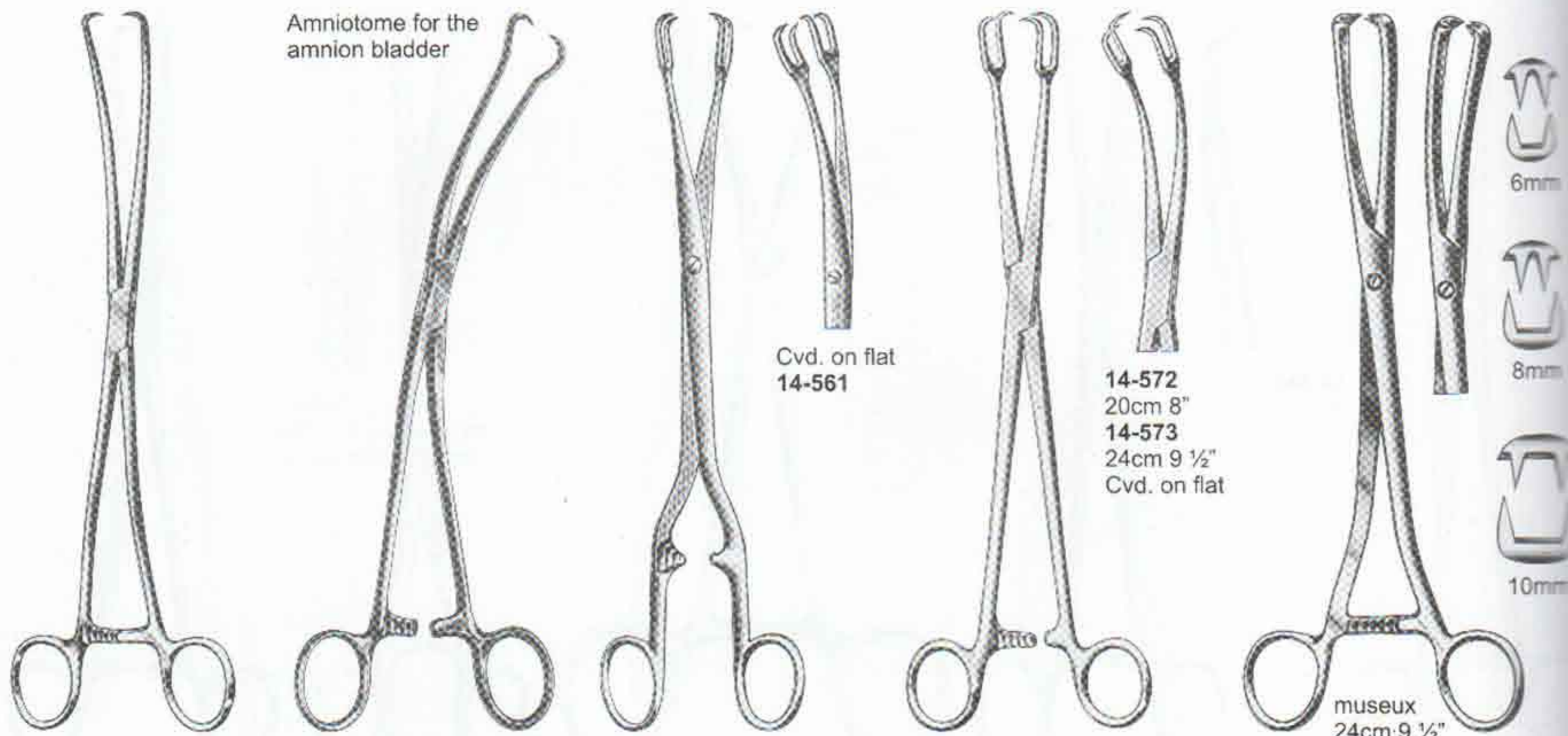

**DUPLAHY**  
14-540  
28cm 11"

**SKENE**  
14-550  
24cm 9 1/2"

**SCHROEDER**  
14-560  
26cm 10 1/4"

**SCHROEDER**  
14-570  
20cm 8"  
14-571  
24cm 9 1/2"

**museux**  
24cm 9 1/2"

Str.	Cvd. sideways	Jaw Width mm
14-580	14-583	6
14-581	14-584	8
14-582	14-585	10

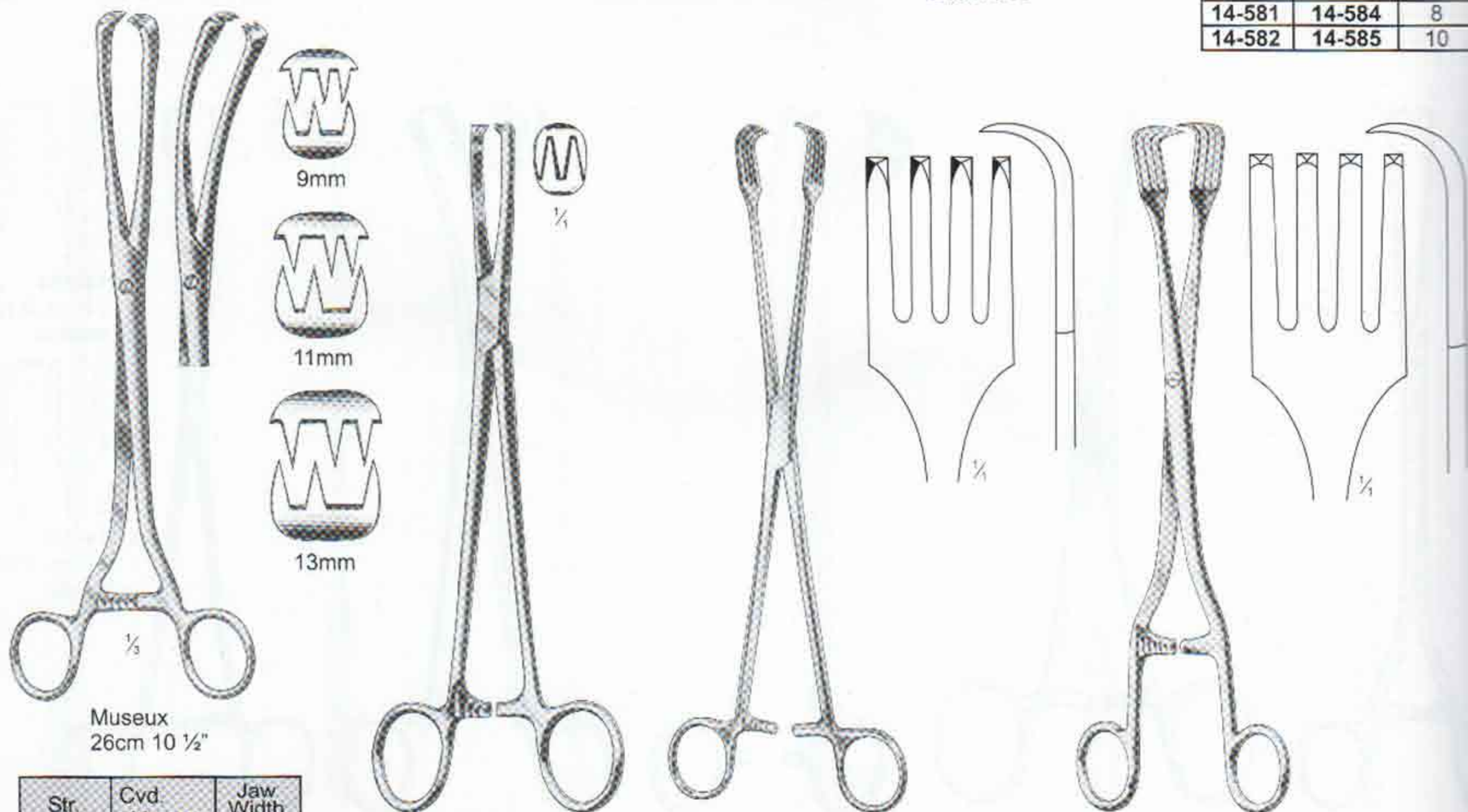

**Museux**  
26cm 10 1/2"

Str.	Cvd. sideways	Jaw Width mm
14-590	14-593	9
14-591	14-594	11
14-592	14-595	13

**Henrotin**  
14-600  
20.5cm 8"

**14-610**  
26cm 10 1/4"

**Pratt**  
14-620  
28cm 11"



# UTERINE TENACULUM FORCEPS



Hakenzangen, amniotom  
Pinza para cuello uterino, amniótomo

Pince pour le col de l'utérus, amniotome  
Pinza per il collo dell'utero, amniotomo

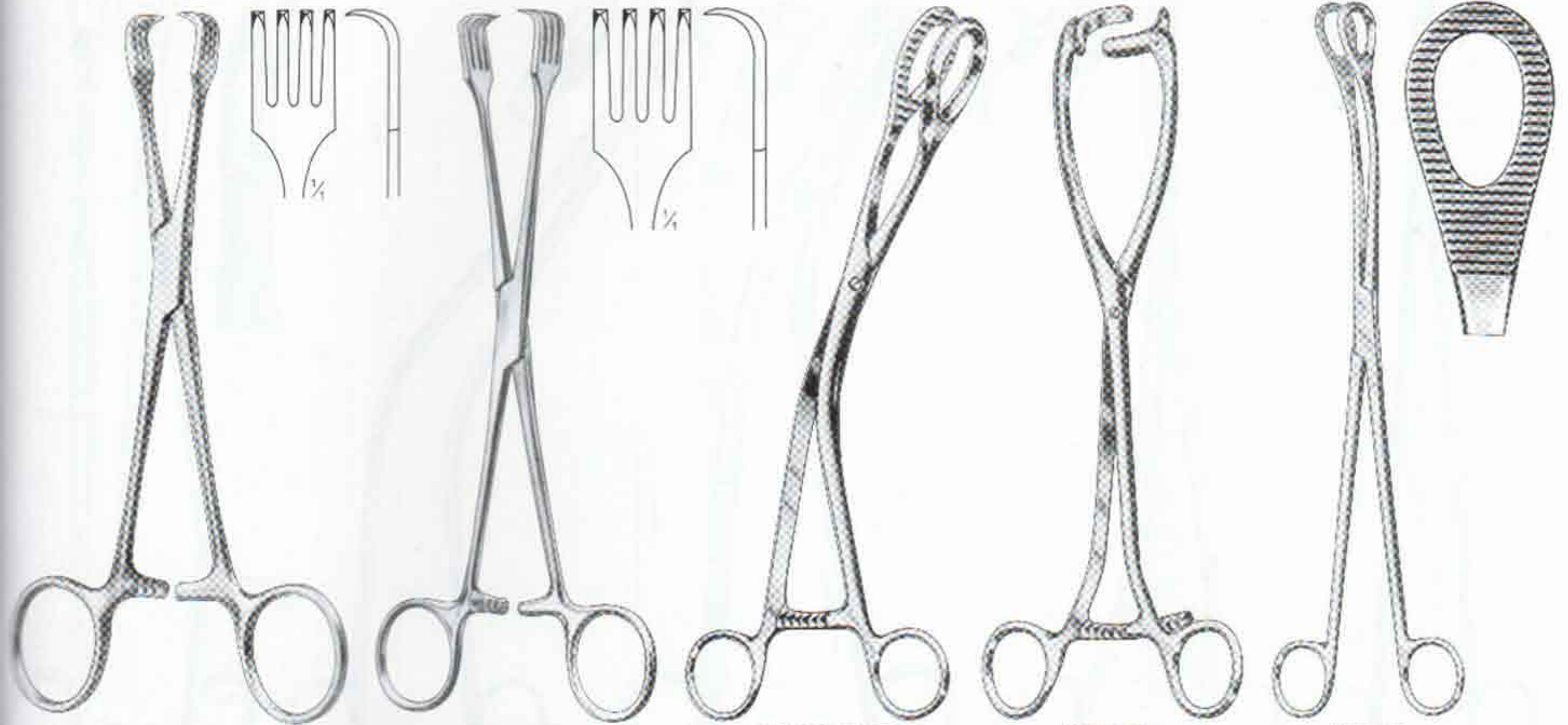

**BRAUN**  
14-630  
15.5cm 6 1/4"

**CZERNY**  
14-640  
20.5cm 8 1/4"

**PRUESMANN**  
14-650  
27.5cm 10 3/4"

**COLLIN**  
14-660  
25cm 10"

**KELLY**  
14-670  
32cm 12 1/2"

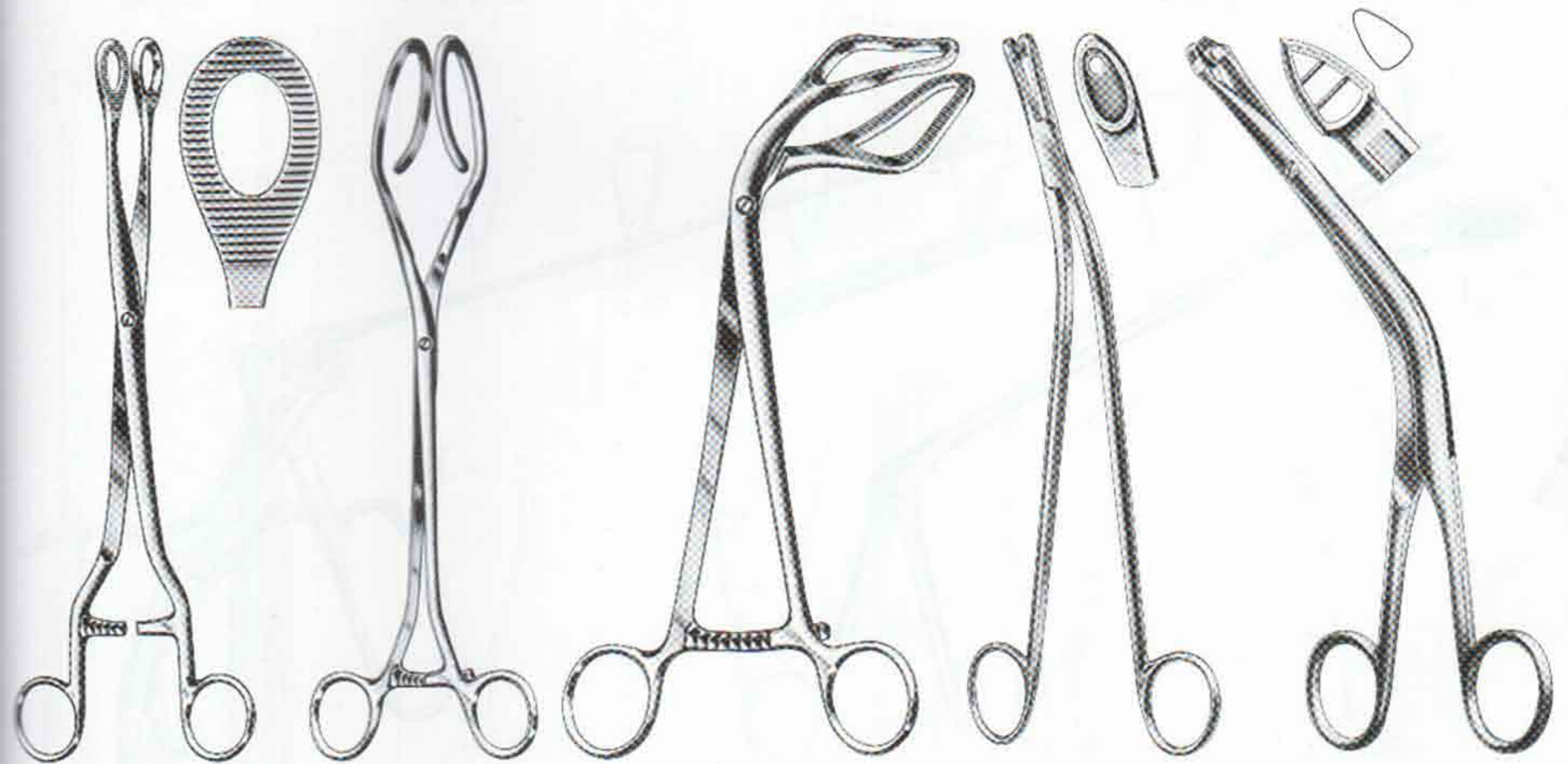

**NOTO**  
14-680  
27cm 10 1/2"

**DARTIGUES**  
14-690  
27cm 10 1/2"

**SOMER**  
14-700  
23cm 9"

**GELLHORN**  
14-710  
23cm 9"

**FAURE**  
14-720  
21cm 8 1/4"



# UTERINE TENACULUM FORCEPS

Hakenzangen, amniotom  
Pinza para cuello uterino, amniótomo

Pince pour le col de l'utérus, amniotome  
Pinza per il collo dell'utero, amniotomo

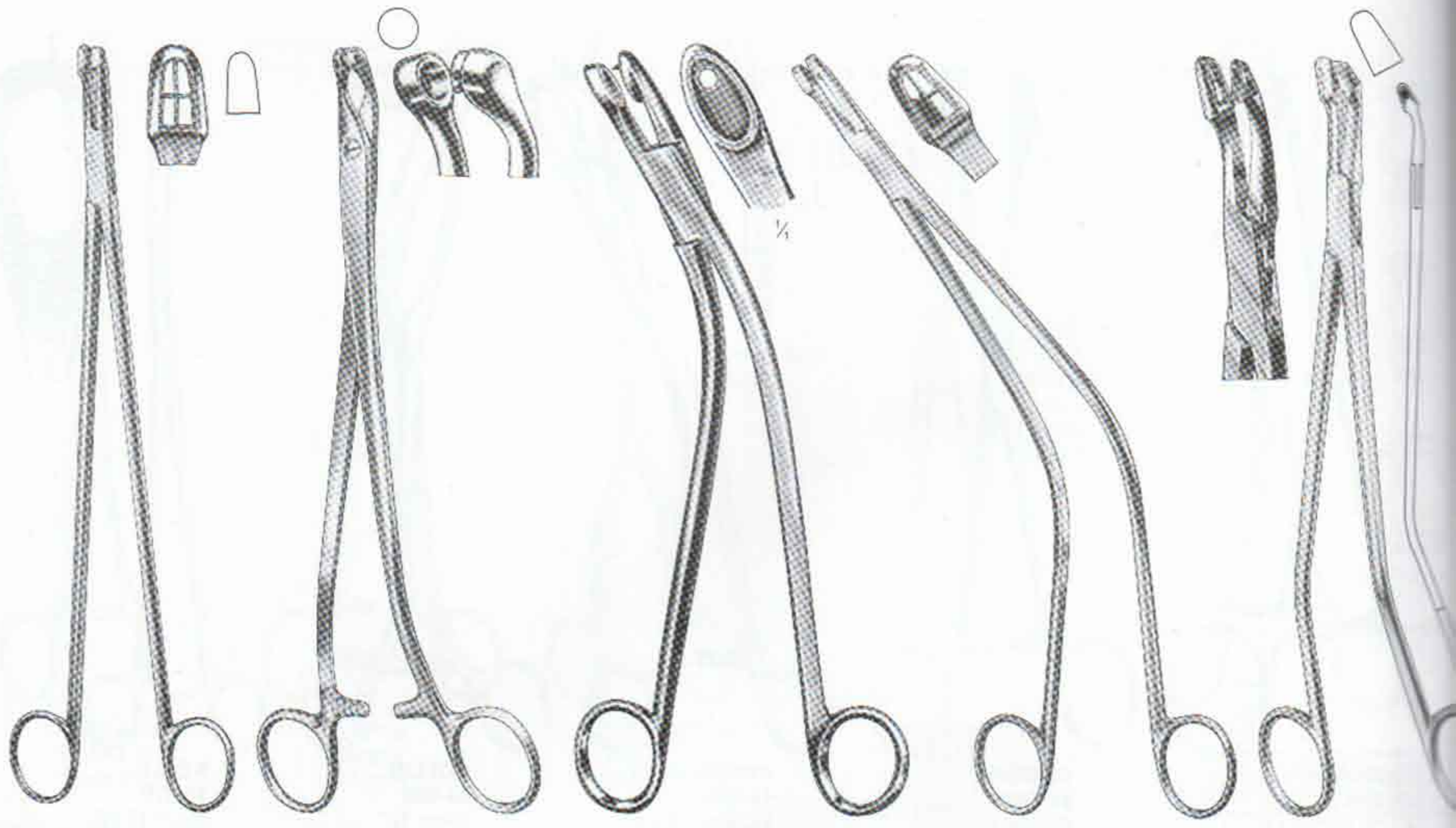

**SCHUBERT**  
14-730 21cm 8 1/4"  
14-731 29cm 11 1/2"

**THOMS-GAYLOR**  
14-740  
24cm 9 1/2"

**GELLHORN**  
Biopsy Punch Forceps  
14-750  
24cm 9 1/2"

**SCHUBERT**  
14-760  
26cm 10 1/4"

**VAN DOREN**  
14-770  
25cm 10"



**ALEXANDER**  
14-780  
28cm 11"

**SCHUMACHER**  
14-790  
Forcep with  
exchangeable tip



# UTERINE SCOOPS, SUCTION CURETTES & UTERINE DEPRESSOR



Uteruslöffel, Absaugküretten, uterusdepressor

Curettes uterines, curettes d'aspiration, Dépresseur utérin

Cucharillas uterinas, Curetas aspiradoras, depresor uterino

Curette uterine, curette pe aspirazione, depressore uterino

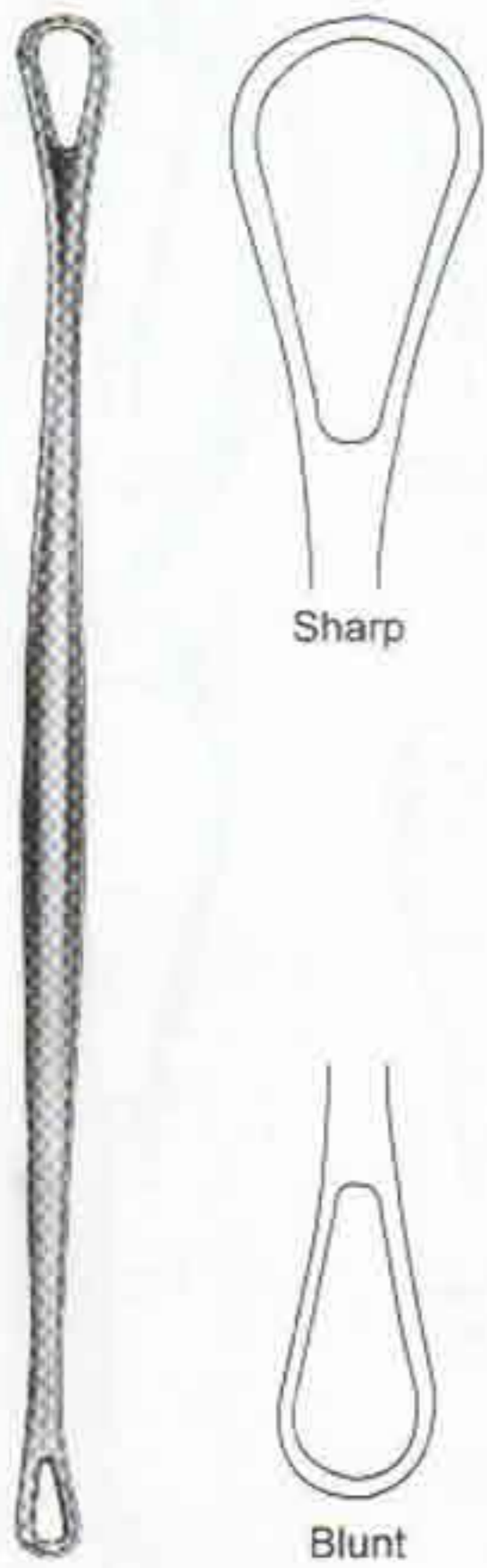

**BLAKE**  
14-800  
27 cm, 10 3/4"

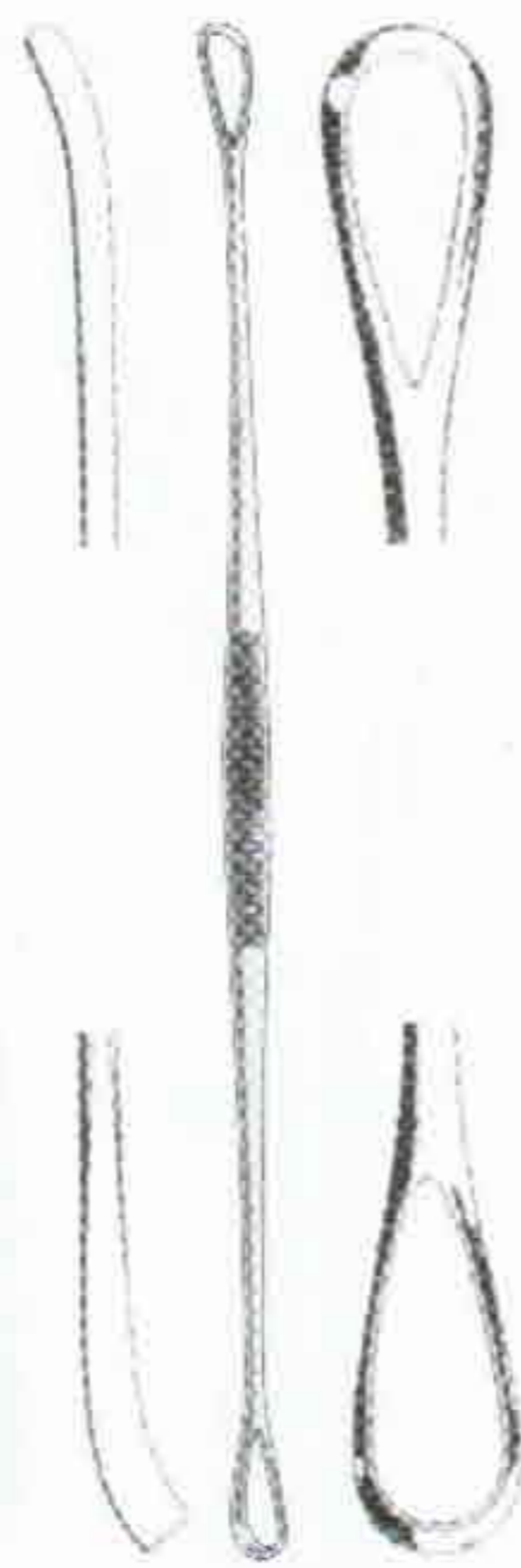

**ZWEIFEL**  
14-810  
31 cm



**SIMS**  
14-820  
31cm 12 1/2"  
malleable

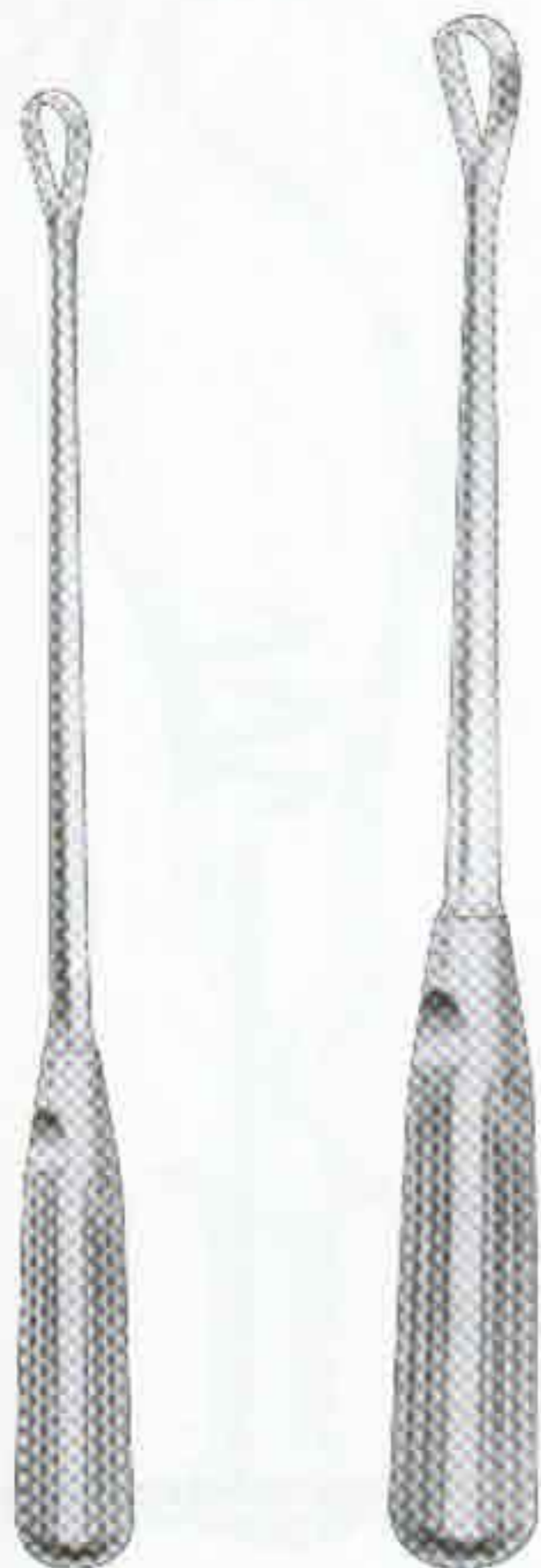
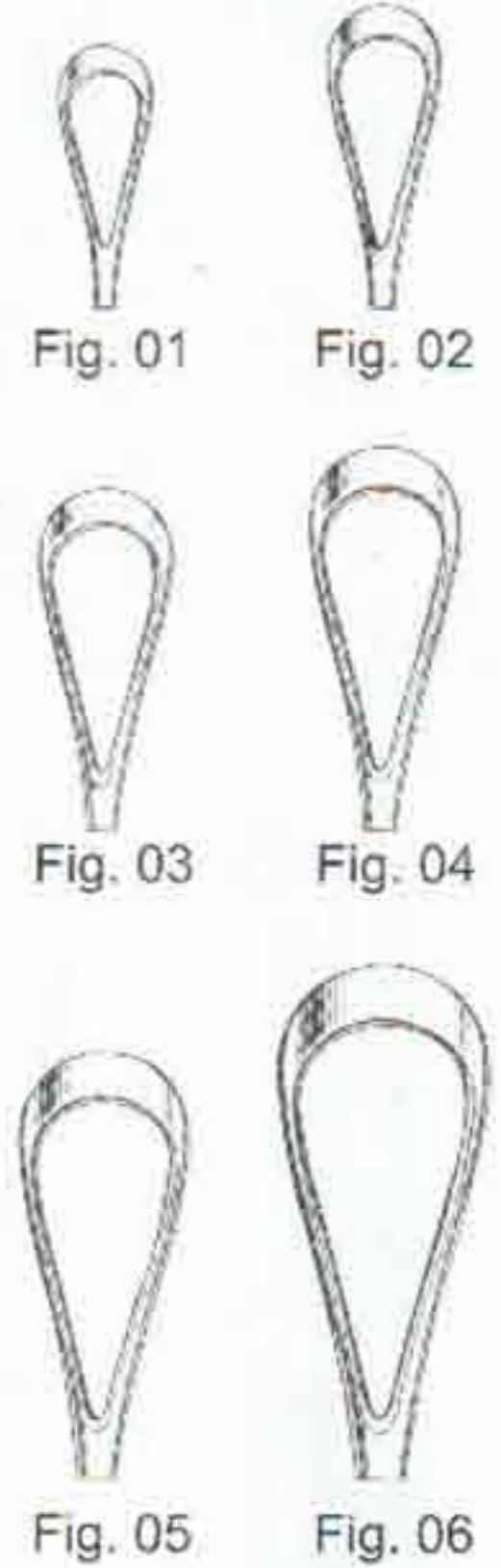

**RECAMIER** 14-830  
26cm  
malleable

**RECAMIER** 14-840  
31cm  
malleable

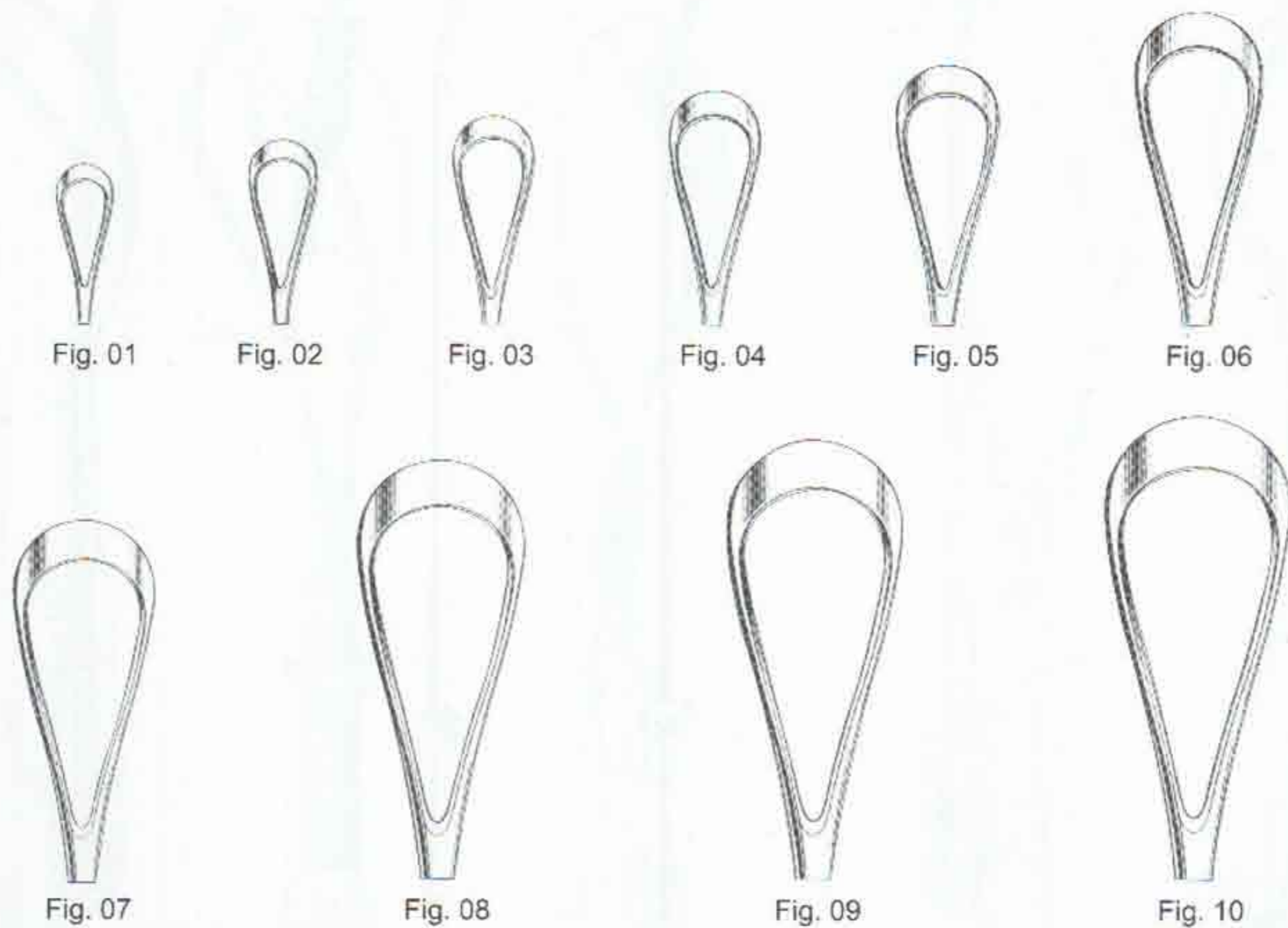



# UTERINE SCOOPS, SUCTION CURETTES & UTERINE DEPRESSOR

Uteruslöffel, Absaugküretten, uterusdepressor

Cucharillas uterinas, Curetas aspiradoras, depresor uterino

Curettes uterines, curettes d'aspiration, Dépresseur utérin

Curette uterine, curette pe aspirazione, depressore uterino



**SIMS**  
14-850  
25cm



Fig. 01



Fig. 02



Fig. 03



Fig. 04



Fig. 05



Fig. 06



**THOMAS**  
14-860  
28cm



Fig. 01



Fig. 02



Fig. 03



Fig. 04



Fig. 05



Fig. 06



**COLLIN**  
14-870  
28cm 11"  
Uterine sound with  
slide & adjustable shaft



**VALLEIX**  
14-880  
25cm 10"  
ditto, with slide



**RANDALL**  
14-890  
24cm 9 1/2"



**NOVAK**  
14-900  
23cm 9"  
4mmØ



**SEGOND**  
14-910



**DOYEN**  
14-920  
17cm 6 3/4"



# OBSTETRICAL FORCEPS

Geburtszangen  
Forceps obstétricos

Forceps obstétriques  
Forcipi obstetrici

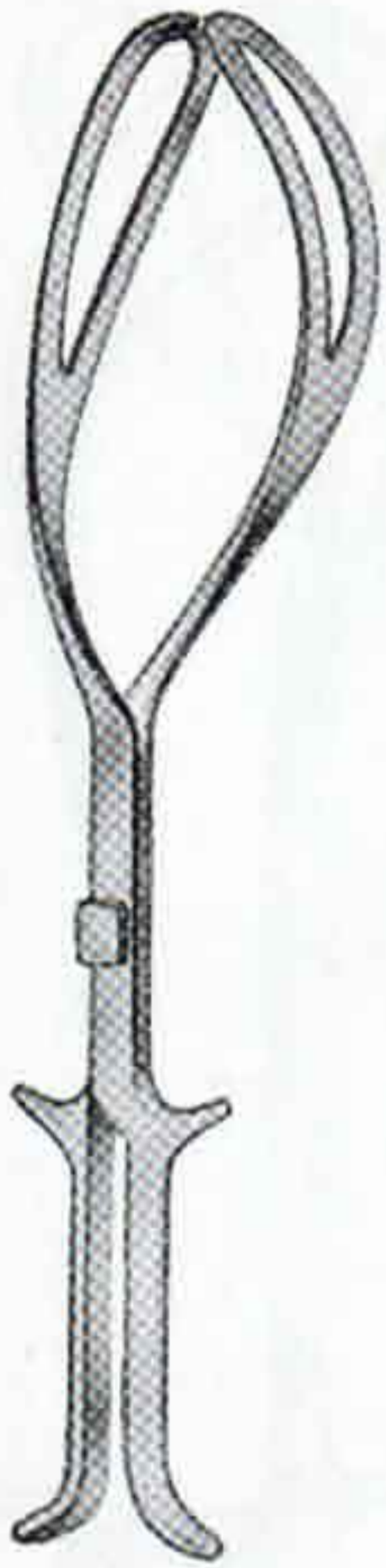

**KIELLAND**  
14-930  
41 cm, 16"

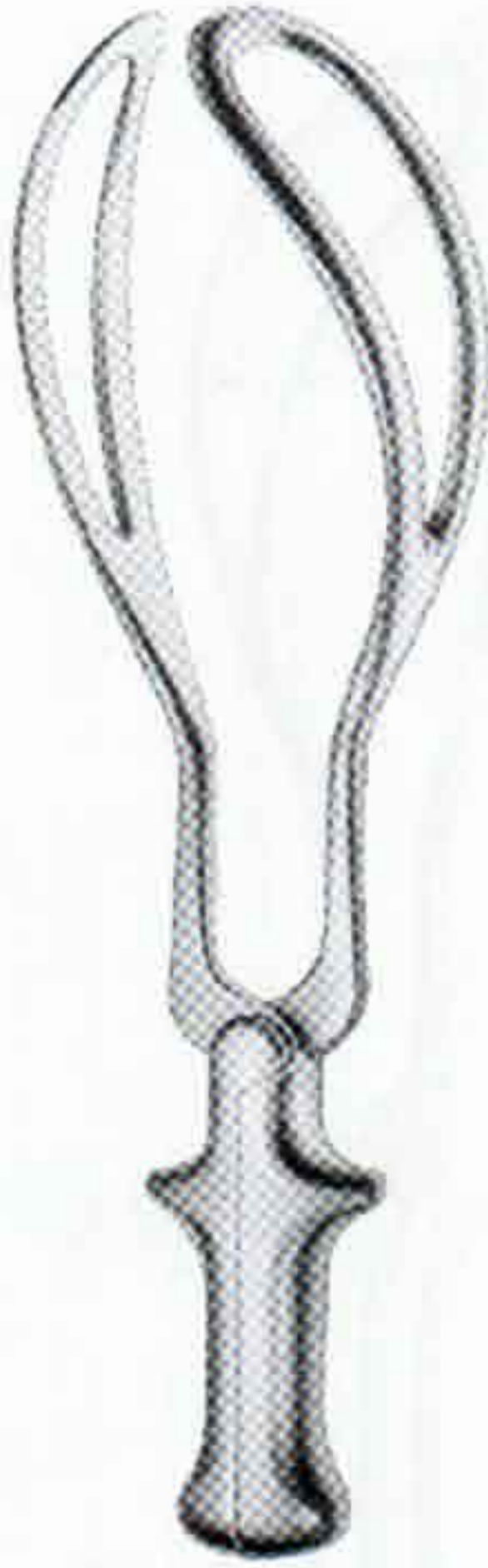

**SIMPSON**  
14-940  
30 cm, 12"

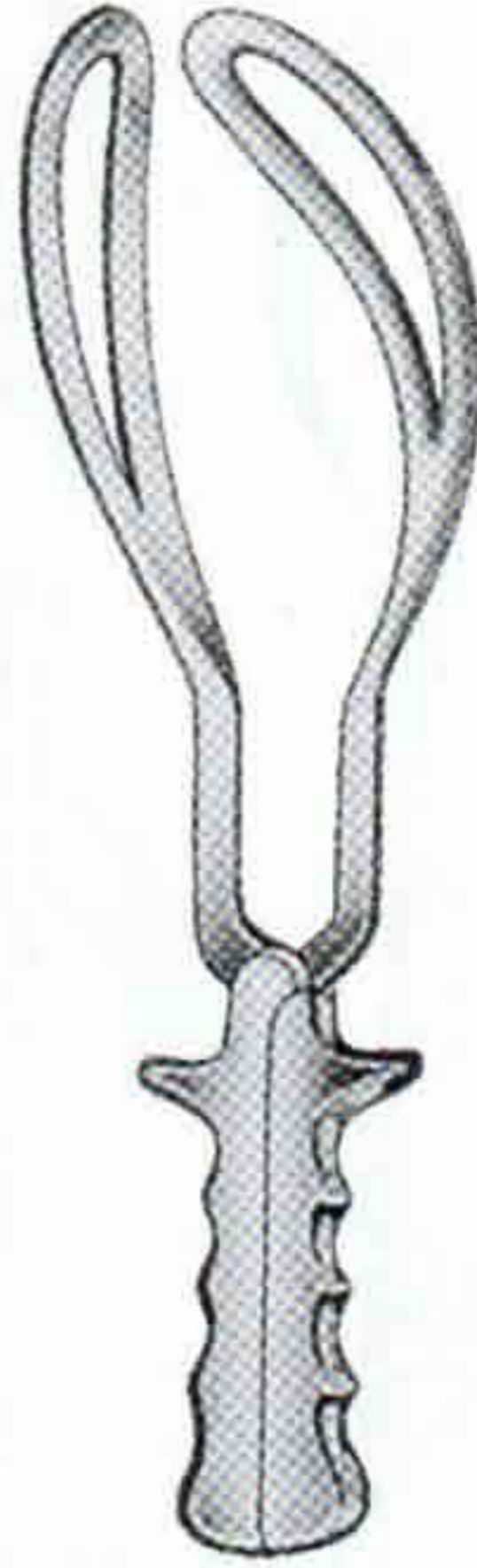

**SIMPSON-BRAUN**  
14-950 33 cm, 13 1/2"  
14-951 38 cm, 14 1/2"



**DE LEE**  
14-960  
30 cm, 12"

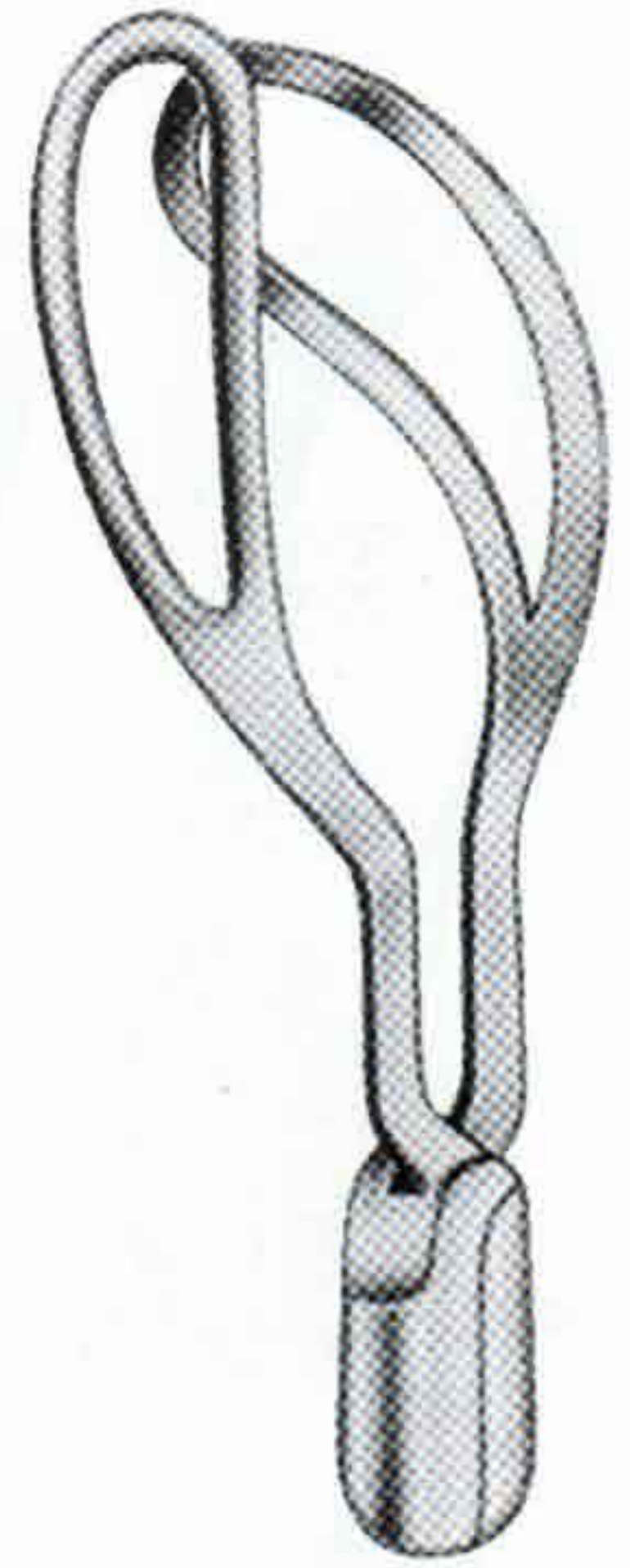

**WRIGLEY**  
14-970  
23 cm, 9"

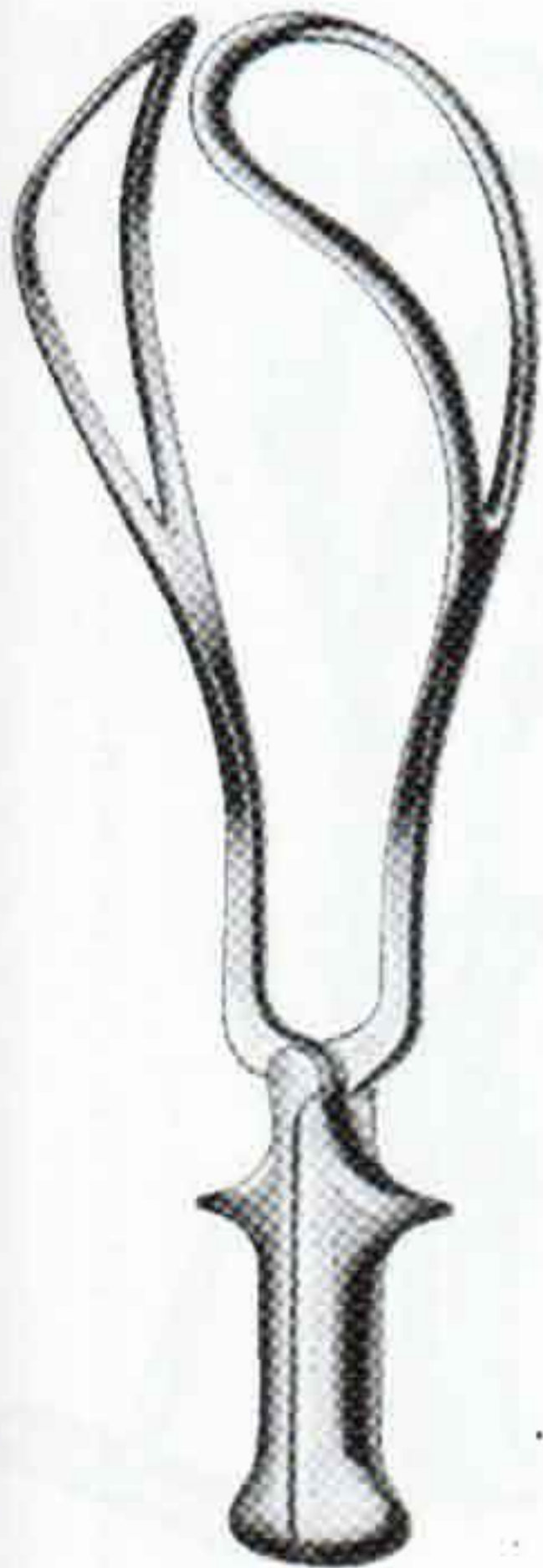

**DE LEE**  
14-980  
30cm 12"

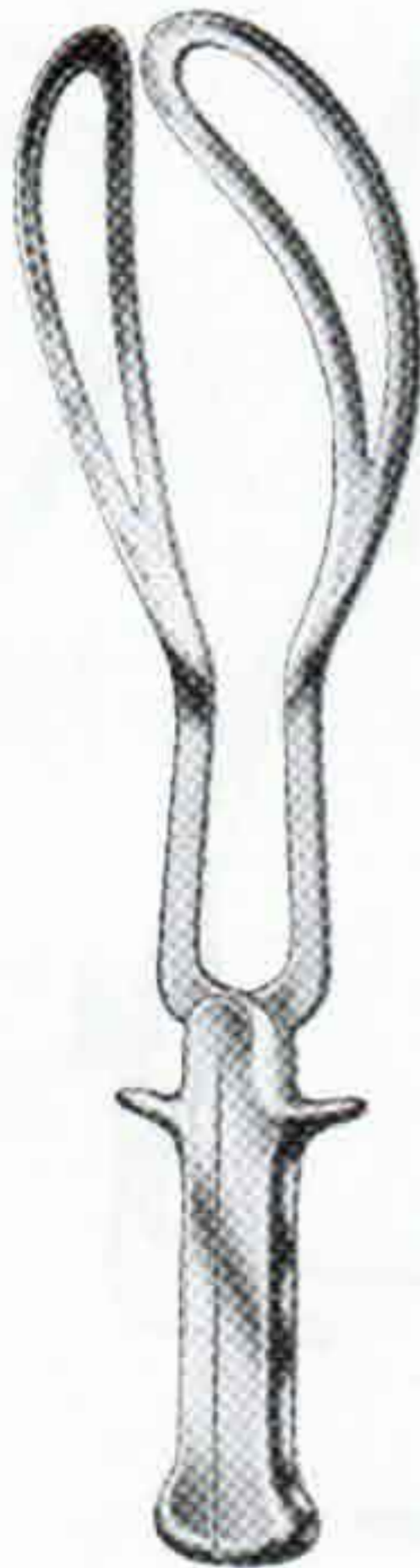

**DE LEE**  
14-990  
36cm 14"



**ELLIOT**  
14-1000 32cm  
14-1001 38cm

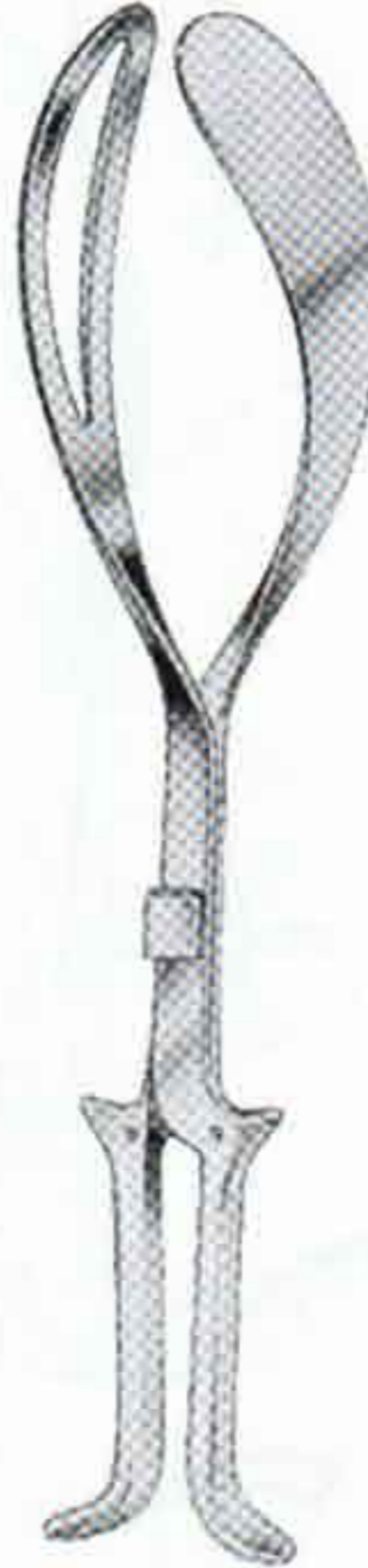

**KIELLAND-LUIKART**  
14-1010  
41 cm, 16"



**NAEGELE**  
14-1020 36 cm, 14 1/4"  
14-1021 40 cm, 15 3/4"



**PIPER**  
14-1030  
44 cm, 18"



# OBSTETRICAL FORCEPS

Geburtszangen  
Forceps obstétricos

Forceps obstétriques  
Forcipi obstetrici



**MCLEAN**  
14-1040  
36 cm, 14 1/4"

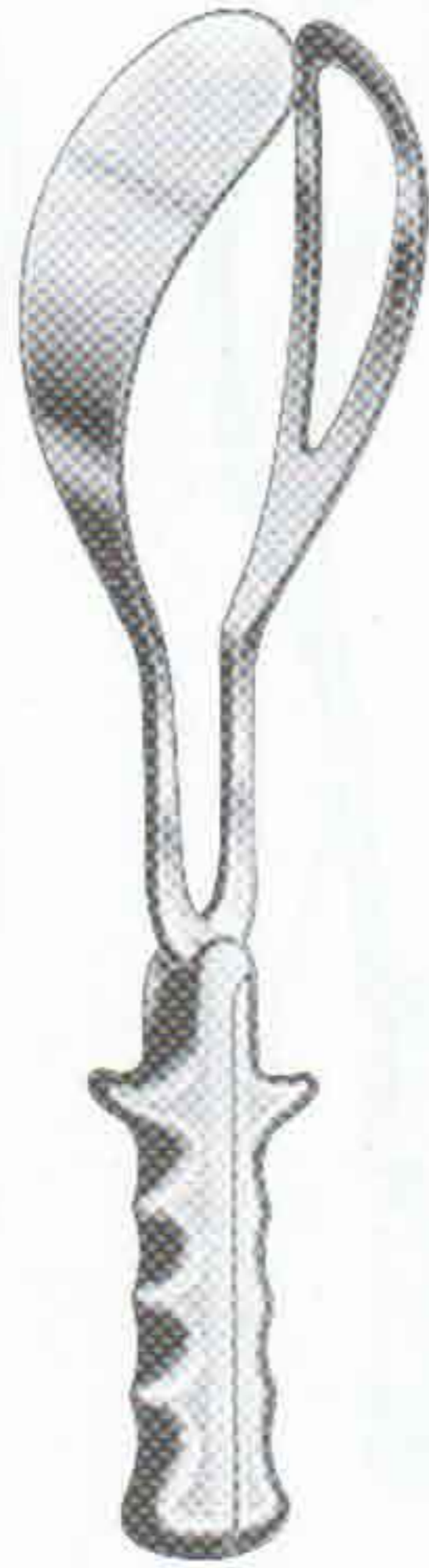

**SIMPSON-LUIKART**  
14-1050  
36cm 14"



**Mc LEAN-TUCKER**  
14-1060  
39cm 15"

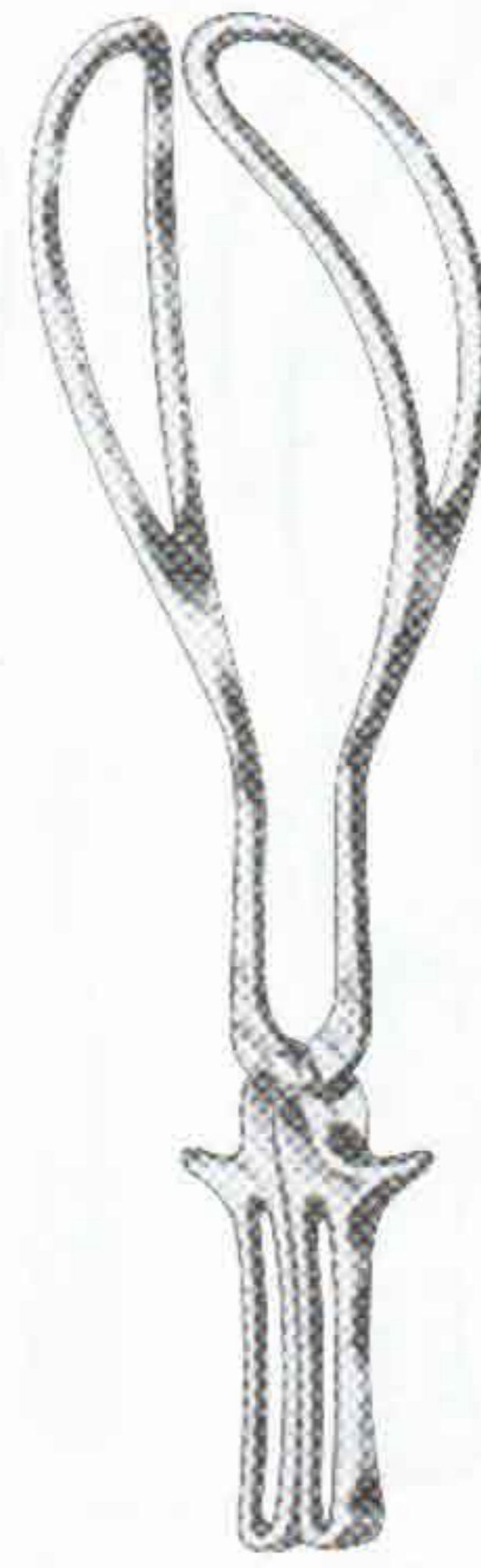

**KEDARNATH DAS**  
14-1070  
33cm



**BOERMA**  
14-1080  
29cm

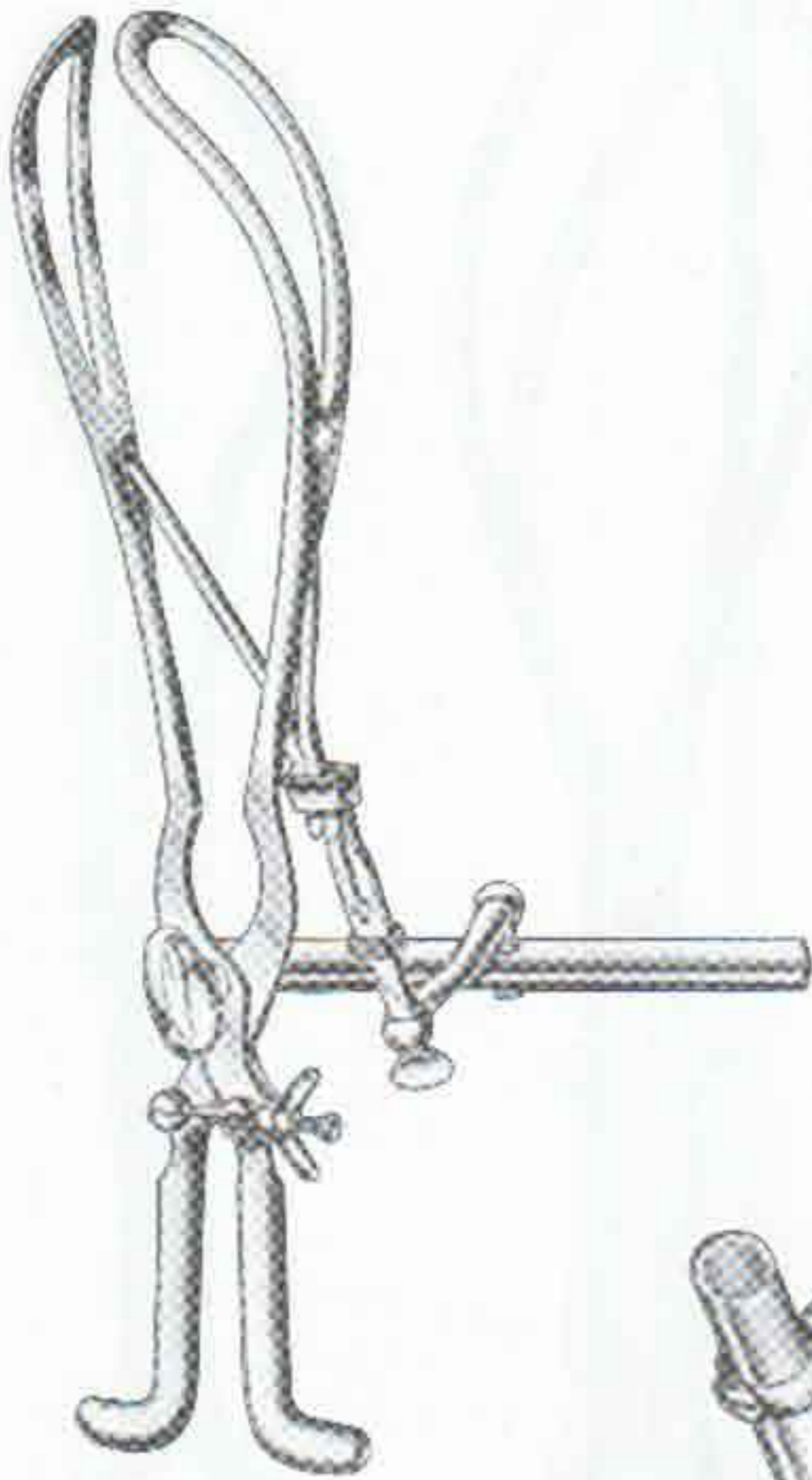

**TARNIER**  
14-1090  
40cm 15 3/4"  
with traction handle

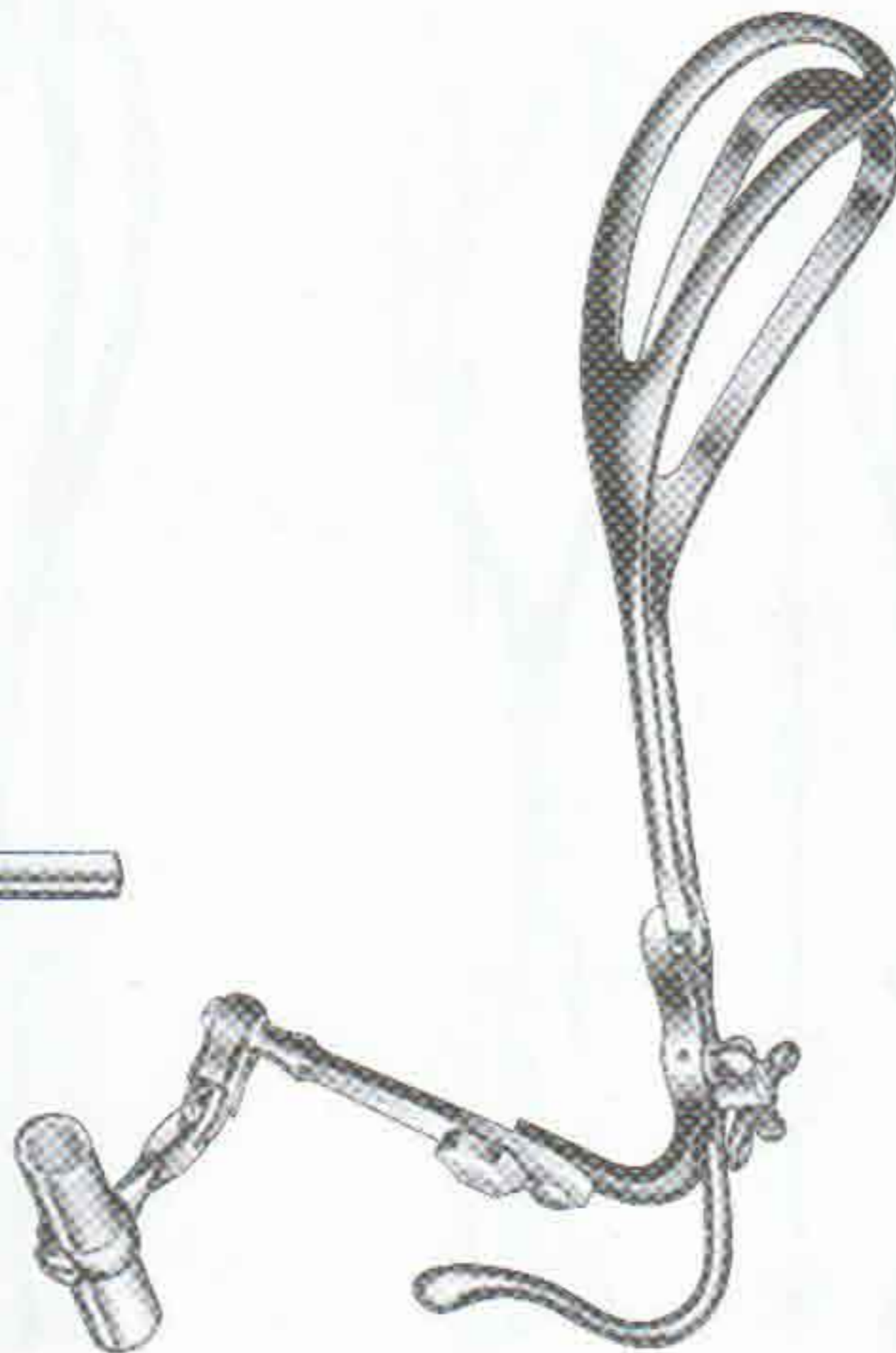

**DEWEY**  
14-1100  
37cm 14 1/2"  
with traction handle



**PIPER**  
14-1110  
40cm 15 3/4"  
with traction handle

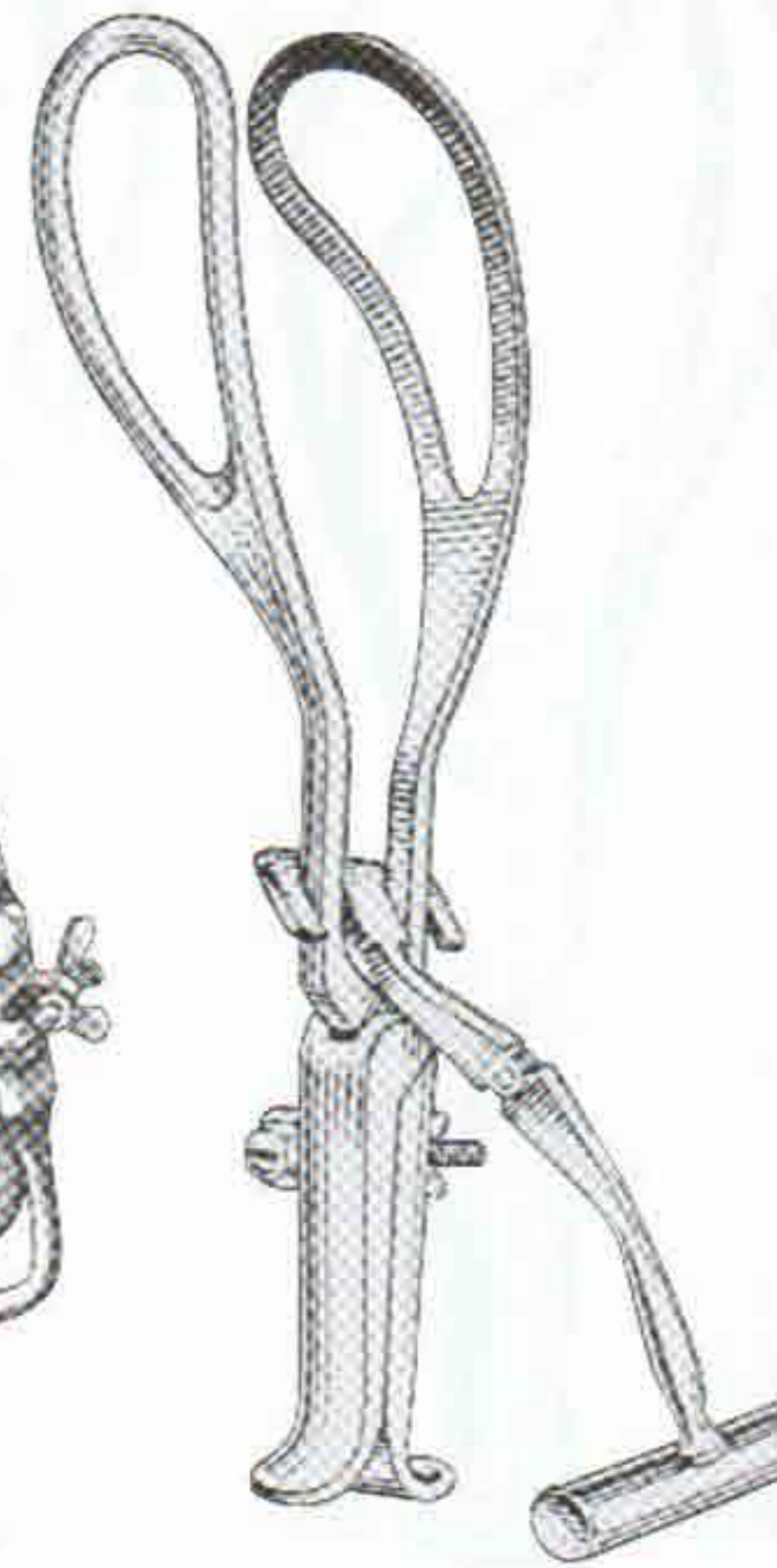

**HAIG FERGUSON**  
14-1120  
detachable axis traction  
rod & handle.



# OBSTETRICAL FORCEPS

Geburtszangen  
Forcips obstétricos

Forcips obstétriques  
Forcipi obstetrici



**BARNES-NEVILLE**  
14-1130  
Simpson handles, detachable  
axis traction rod and handle.

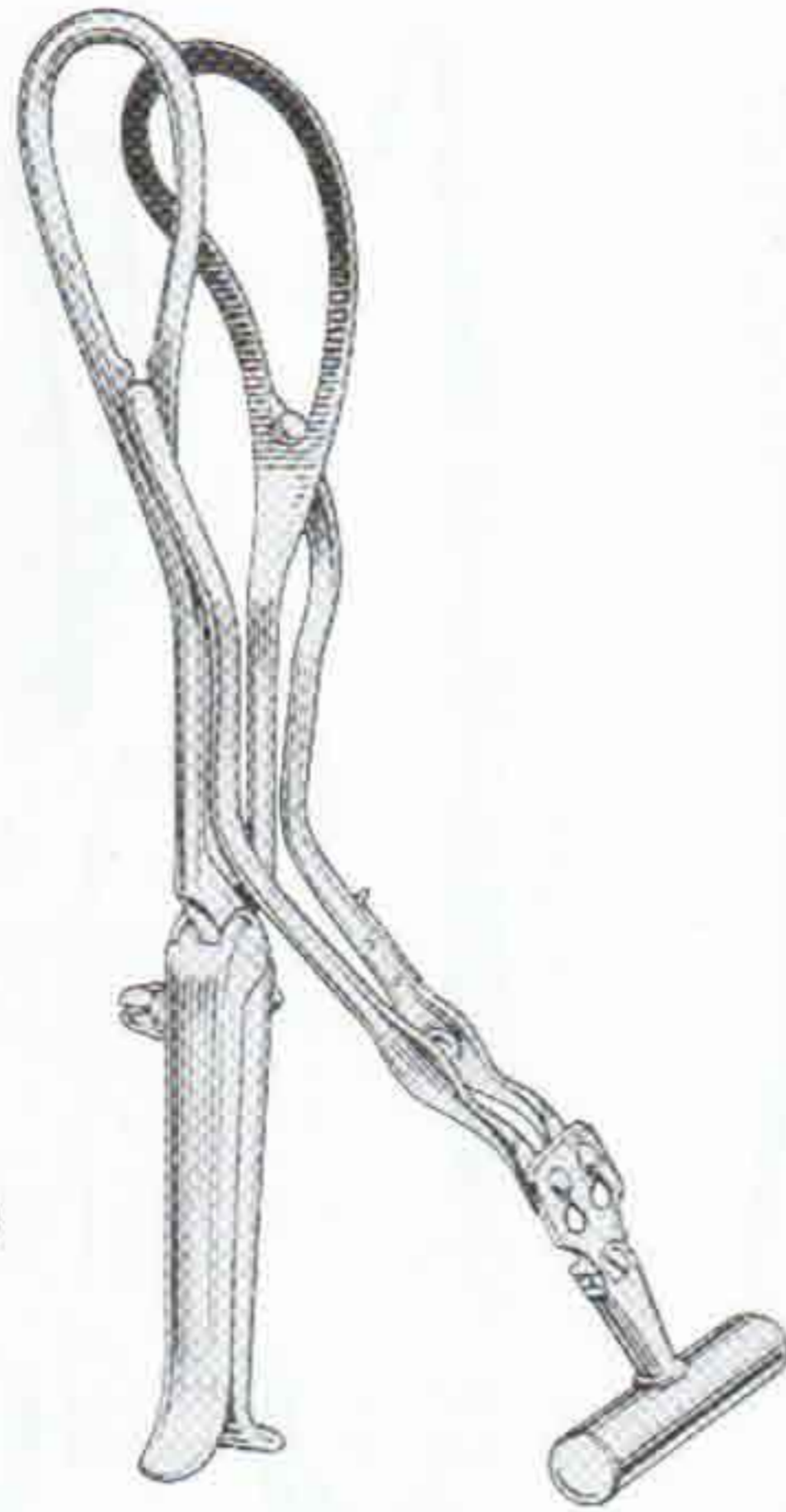

**MILNE MURRAY**  
14-1140  
detach-able axis traction  
rod & handle.



**BRAUN**  
14-1150  
42 cm, 16 1/4"

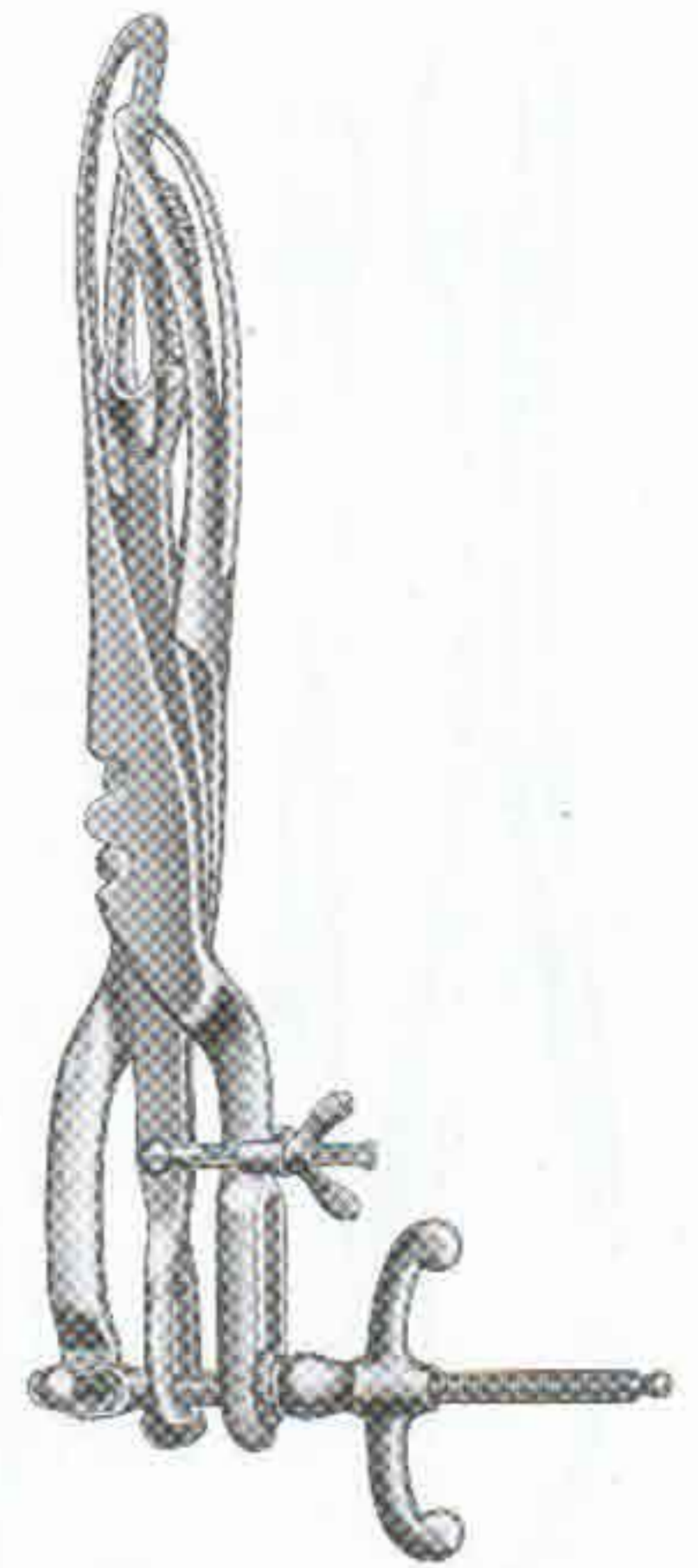

**TARNIER**  
14-1160  
44 cm, 17 1/4"

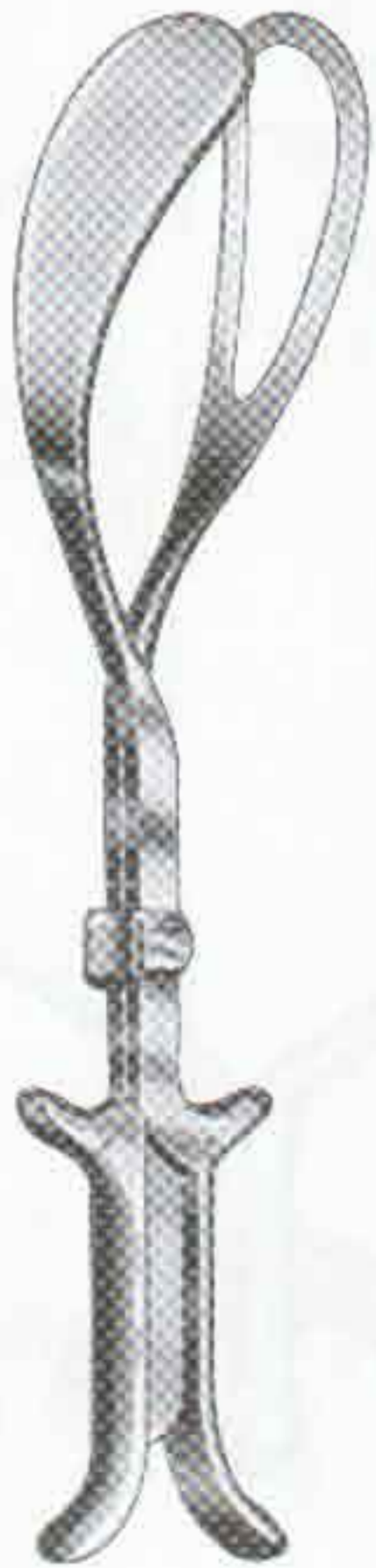

**LUIKART**  
14-1170  
40cm 15 3/4"

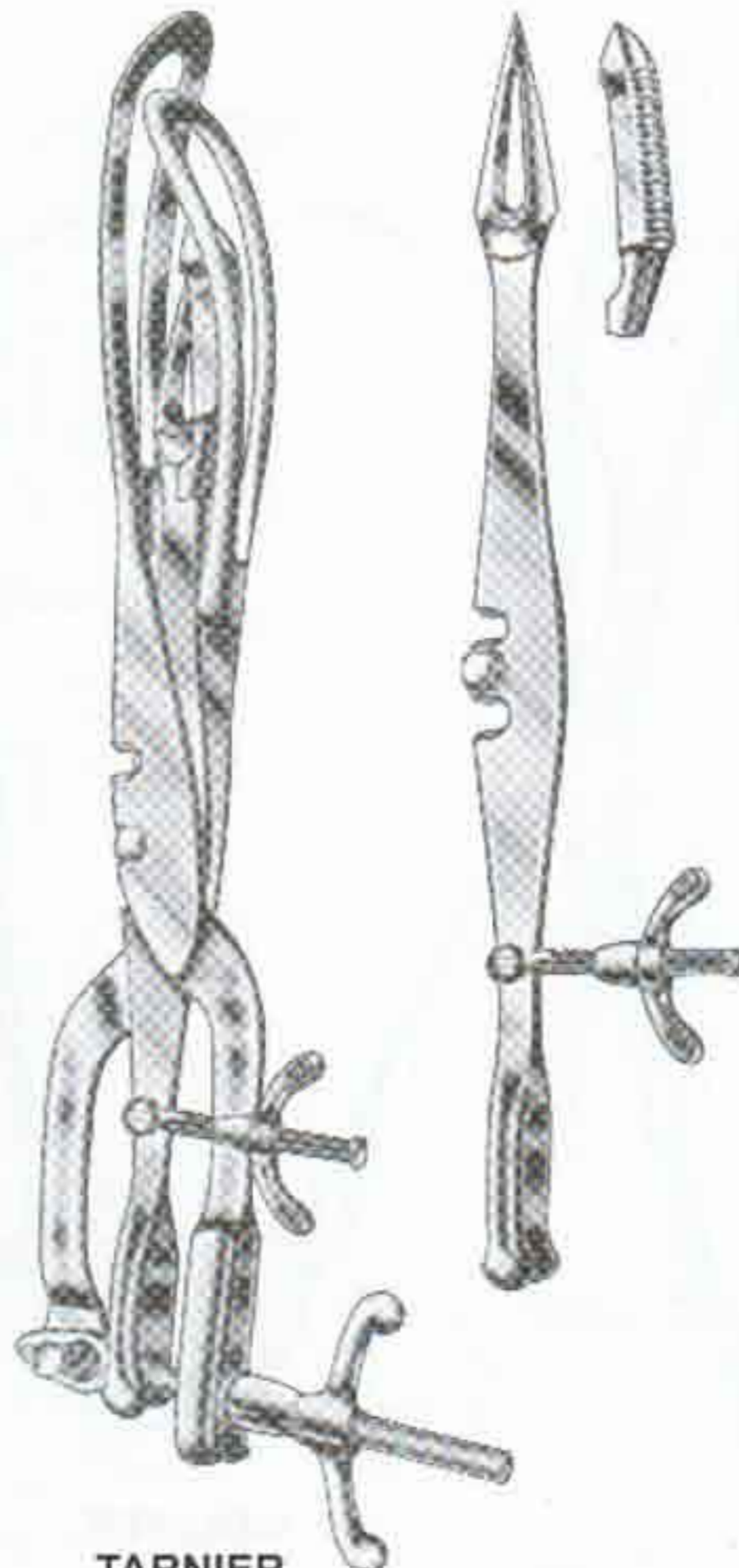

**TARNIER**  
14-1180  
46cm 18"

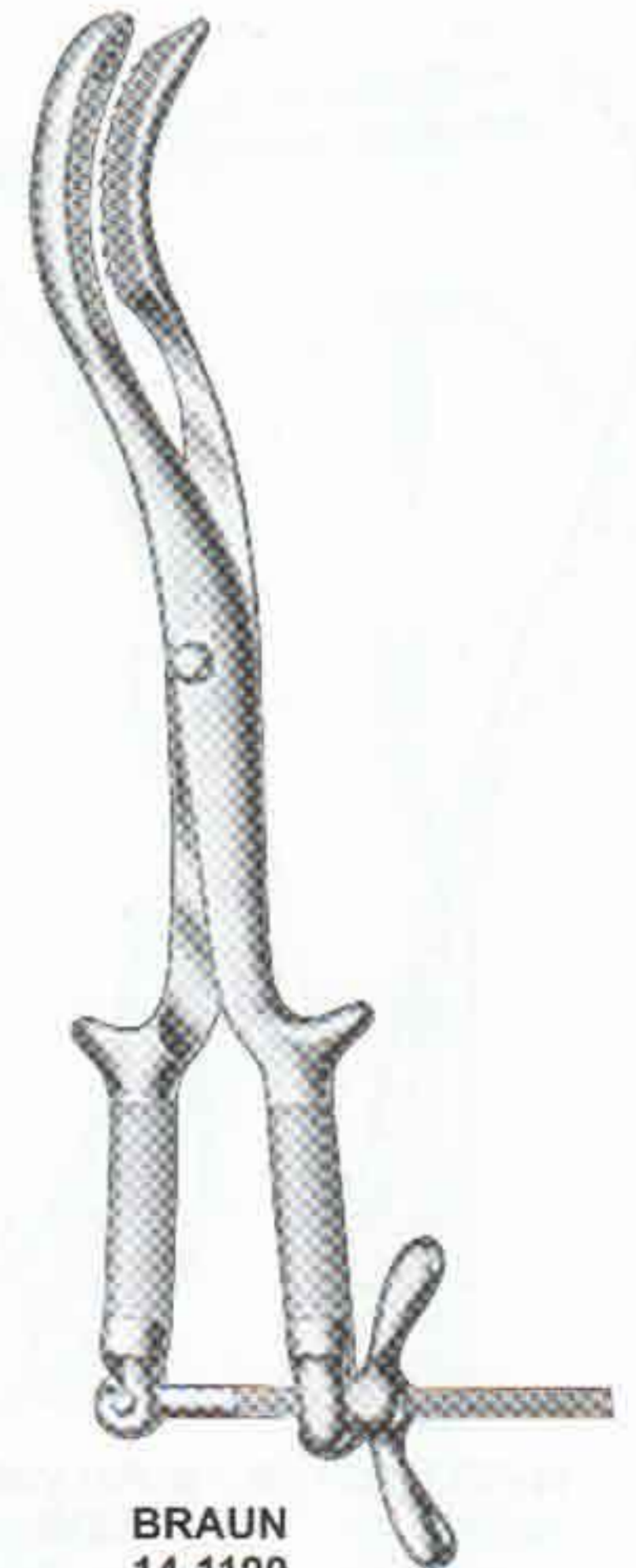

**BRAUN**  
14-1190  
42cm 16 1/2"



# OBSTETRICAL FORCEPS

Geburtszangen  
Forceps obstétricos

Forceps obstétriques  
Forcipi obstetrici



**NAEGELE**  
14-1200  
25 cm, 10"



**SMELLIE**  
14-1210  
25 cm, 10"



**BRAUN**  
14-1220  
30 cm, 12"



**SMELLIE**  
14-1230  
30 cm, 12"



**TARGET**  
14-1240  
26cm



**TARGET**  
14-1250  
30cm



**M-PELVIMETER**  
14-1260  
34cm 13 1/2"  
cm scale



**M-PELVIMETER**  
14-1270  
34cm 13 1/2"  
in/cm scale



**COLLIN**  
14-1280  
35cm 13 3/4"  
cm scale



**COLLYER**  
14-1290  
30cm 12"  
cm/Inch scale



**BREISKY**  
14-1300  
33cm 13"  
cm/Inch scale



# OBSTETRICAL FORCEPS

Geburtszangen  
Forceps obstétricos

Forceps obstétriques  
Forcipi obstetrici

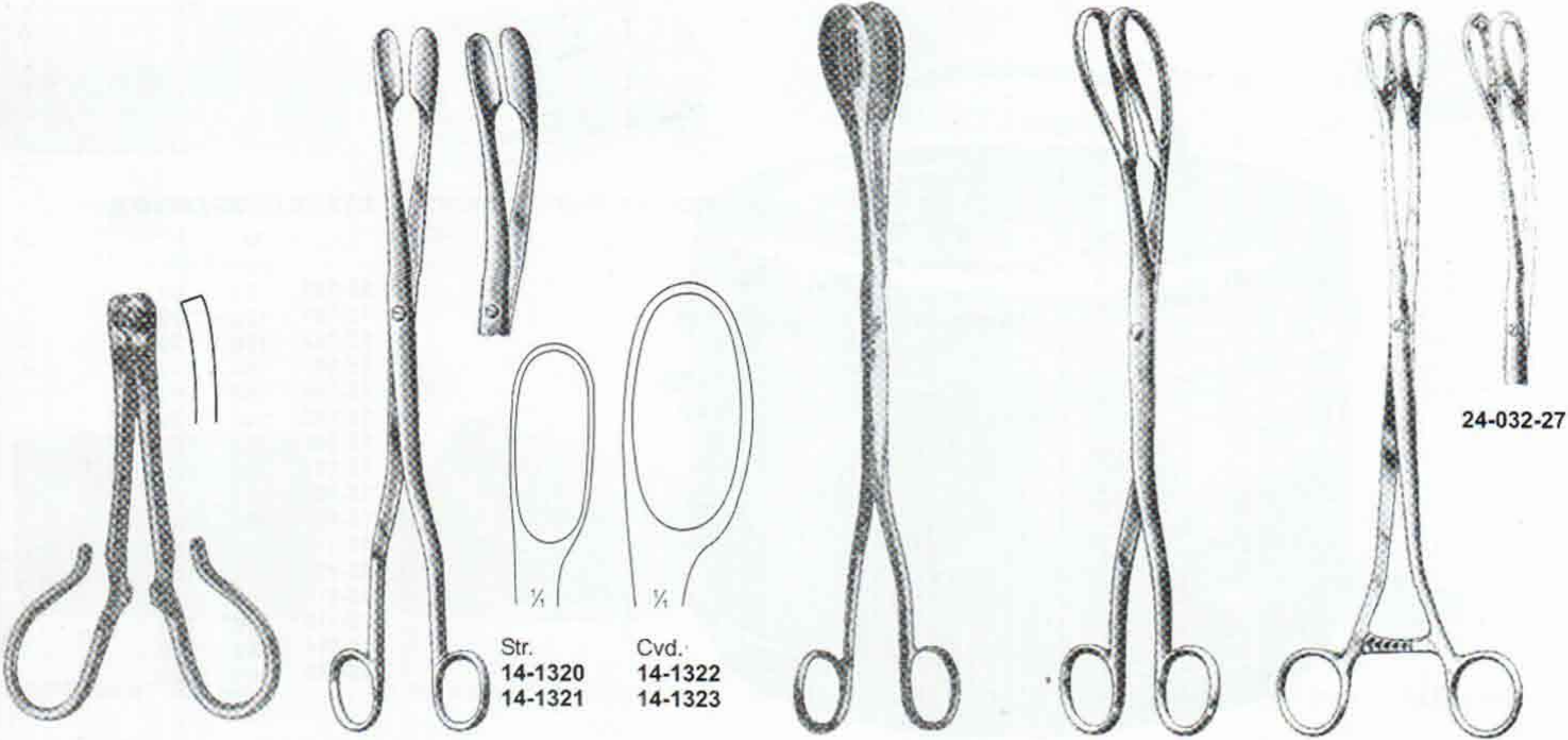

**KANE**  
14-1310  
8.5cm

**WINTER**  
28cm 11"

Str.  
14-1320  
14-1321

Cvd.  
14-1322  
14-1323

**HEYWOOD-SMITH**  
14-1330  
25.5cm

**COREY (GREENHALG)**  
14-1340  
24cm 9 1/2"

**SAENGER**  
14-1350  
27cm 10 1/2"

24-032-27



**GREEN-ARMYTAGE**  
14-1360  
21cm 8 1/4"  
Str. & Cvd.

**WILLETT**  
14-1370  
Scalpel Flap Forceps  
18.5 cm, 7 1/4"

**GAUSS**  
14-1380  
Scalpel Flap Forceps  
26 cm, 10 1/4"

**MURLESS**  
14-1390  
26cm 10 1/4"

**SELLHEIM**  
14-1400  
28cm 11"





### STERILIZING DRUMS

	Ø mm	h mm
15-100	80	80
15-101	120	120
15-102	160	120
15-103	190	140
15-104	190	200
15-105	240	120
15-106	240	160
15-107	240	240
15-108	290	120
15-109	290	160
15-110	290	240
15-111	340	160
15-112	340	240
15-113	390	145
15-114	390	200
15-115	390	290



### STERILIZING DRUM

	Ø mm	h mm
15-120	150	150
15-121	175	175
15-122	190	190
15-123	200	140
15-124	200	200
15-125	240	120
15-126	225	225
15-127	240	240
15-128	290	160
15-129	280	240
15-130	230	150
15-131	300	250
15-132	340	250
15-133	350	250
15-134	390	200



### STERILIZING DRUM

	Ø mm	h mm
15-140	150	150
15-141	175	175
15-142	190	190
15-143	200	140
15-144	200	200
15-145	240	120
15-146	225	225
15-147	240	240
15-148	290	160
15-149	280	240
15-150	230	150
15-151	300	250
15-152	340	250
15-153	350	250
15-154	390	200



### STERILIZING DRUM

	Ø mm	h mm
15-160	150	150
15-161	175	175
15-162	190	190
15-163	200	140
15-164	200	200
15-165	240	120
15-166	225	225
15-167	240	240
15-168	290	160
15-169	280	240
15-170	230	150
15-171	300	250
15-172	340	250
15-173	350	250
15-174	390	200



### STERILIZING DRUM

	Ø mm	h mm
15-180	150	150
15-181	175	175
15-182	190	190
15-183	200	140
15-184	200	200
15-185	240	120
15-186	225	225
15-187	240	240
15-188	290	160
15-189	280	240
15-190	230	150
15-191	300	250
15-192	340	250
15-193	350	250
15-194	390	200



# HOLLOW WARES



**G LOVES BOX**  
15-200  
300 x 150 mm



**INSTRUMENT TRAY WITH COVER**  
15-210



**INSTRUMENT TRAY**  
15-220



**CATHER TRAY**  
Size  
15-230 230 x 75 mm  
15-231 350 x 90 mm  
15-232 430 x 100 mm  
15-233 200 x 100 mm  
15-234 300 x 100 mm  
15-235 350 x 100 mm



**INSTRUMENT BOILER**

	Size
15-240	180 x 80 x 40 mm
15-241	200 x 100 x 50 mm
15-242	250 x 125 x 40 mm
15-243	300 x 150 x 60 mm
15-244	350 x 175 x 75 mm
15-245	400 x 200 x 100 mm



**PERFORATED TRAY**

	Size
15-250	180 x 80 x 40 mm
15-251	200 x 100 x 50 mm
15-252	250 x 125 x 40 mm
15-253	300 x 150 x 60 mm
15-254	350 x 175 x 75 mm
15-256	400 x 200 x 100 mm



**INSTRUMENT BOILER WITH STAND**

	Size
15-260	180 x 80 x 40 mm
15-261	200 x 100 x 50 mm
15-262	250 x 125 x 40 mm
15-263	300 x 150 x 60 mm
15-264	350 x 175 x 75 mm
15-265	400 x 200 x 100 mm



**INSTRUMENT BOILER ELECTRIC**

	Size
15-270	180 x 80 x 40 mm
15-271	200 x 100 x 50 mm
15-272	250 x 125 x 40 mm
15-273	300 x 150 x 60 mm
15-274	350 x 175 x 75 mm
15-275	400 x 200 x 100 mm



**PERFORATED BOX**

	Size
15-280	100 x 50 mm
15-281	165 x 65 mm
15-282	250 x 100 mm
15-283	250 x 150 mm
15-284	250 x 200 mm
15-285	150 x 65 mm
15-286	170 x 70 mm
15-287	200 x 100 mm
15-288	250 x 125 mm
15-289	300 x 150 mm
15-290	300 x 200 mm
15-291	300 x 130 mm
15-292	320 x 150 mm
15-293	420 x 180 mm
15-294	460 x 125 mm
15-295	355 x 180 mm
15-296	300 x 180 mm
15-297	400 x 200 mm
15-298	510 x 200 mm

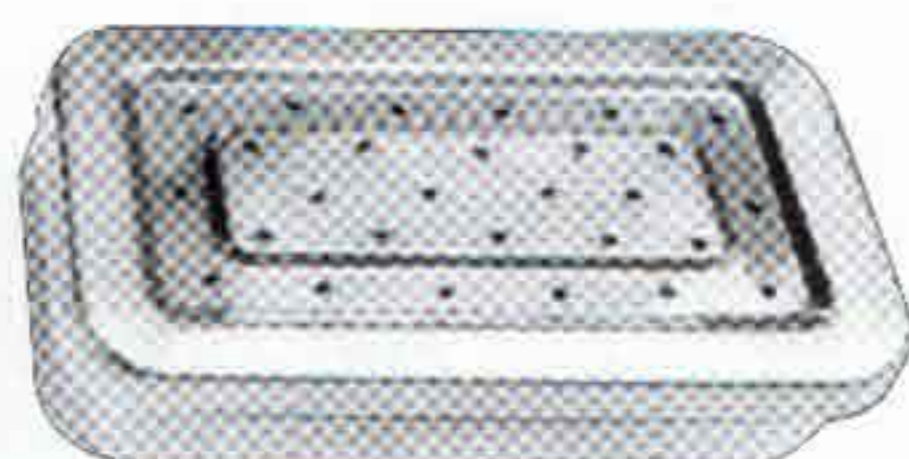

**BOX WITH FILTER**

	Size
15-310	100 x 50 mm
15-311	165 x 65 mm
15-312	250 x 100 mm
15-313	250 x 150 mm
15-314	250 x 200 mm
15-315	150 x 65 mm
15-316	170 x 70 mm
15-317	200 x 100 mm
15-318	250 x 125 mm
15-319	300 x 150 mm
15-320	300 x 200 mm
15-321	300 x 130 mm
15-322	320 x 150 mm
15-323	420 x 180 mm
15-324	460 x 125 mm
15-325	355 x 180 mm
15-326	300 x 180 mm
15-327	400 x 200 mm
15-328	510 x 200 mm



**INSTRUMENTS BOX**

Without Clip	Size
15-340	100 x 50 mm
15-341	165 x 65 mm
15-342	250 x 100 mm
15-343	250 x 150 mm
15-344	250 x 200 mm
15-345	150 x 65 mm
15-346	170 x 70 mm
15-347	200 x 100 mm
15-348	250 x 125 mm
15-349	300 x 150 mm
15-350	300 x 200 mm
15-351	300 x 130 mm
15-352	320 x 150 mm
15-353	420 x 180 mm
15-354	460 x 125 mm
15-355	355 x 180 mm
15-356	300 x 180 mm
15-357	400 x 200 mm
15-358	510 x 200 mm



**INSTRUMENT BOX**

With Clip	Size
15-370	100 x 50 mm
15-371	165 x 65 mm
15-372	250 x 100 mm
15-373	250 x 150 mm
15-374	250 x 200 mm
15-375	150 x 65 mm
15-376	170 x 70 mm
15-377	200 x 100 mm
15-378	250 x 125 mm
15-379	300 x 150 mm
15-380	300 x 200 mm
15-381	300 x 130 mm
15-382	320 x 150 mm
15-383	420 x 180 mm
15-384	460 x 125 mm
15-385	355 x 180 mm
15-386	300 x 180 mm
15-387	400 x 200 mm
15-388	510 x 200 mm





**NEEDLE CASE**  
15-400  
230 x 125 mm

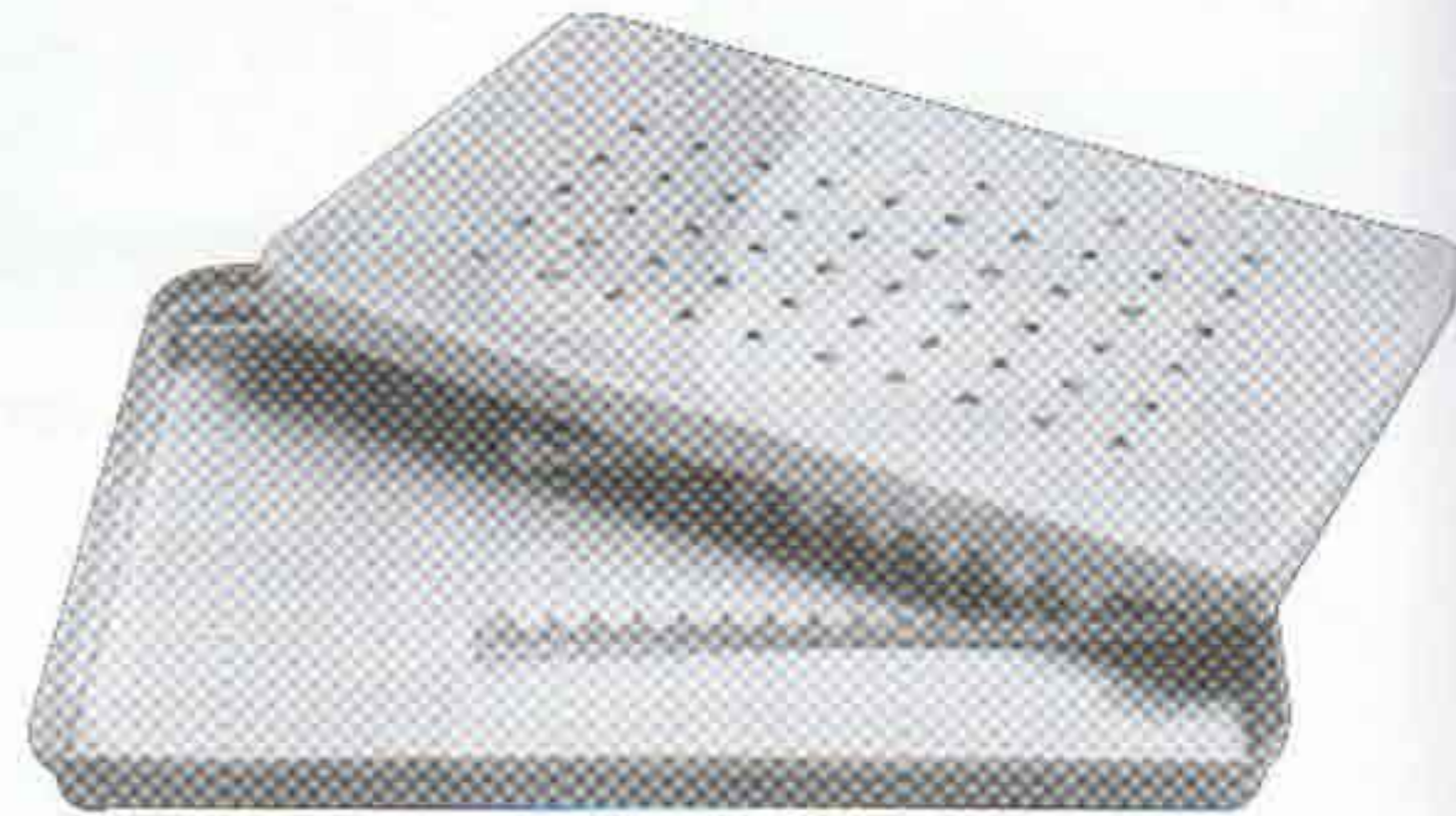

**SCALER BOX**  
15-410  
300 x 180 mm



**SCALER TRAY**  
15-420  
100 x 200 mm



**Autoclaveable**  
15-430



**INDO BOX WITH SILVER FRAME**  
15-440

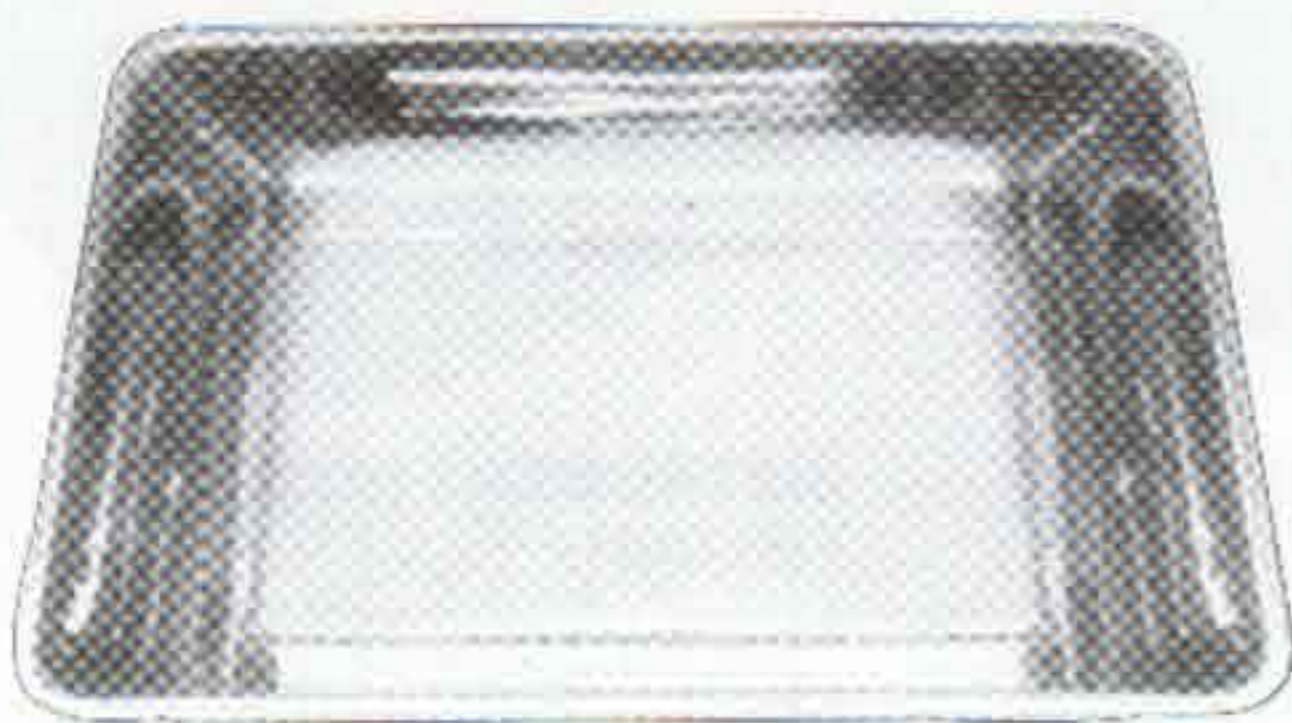

**INSTRUMENT TRAY WITHOUT COVER**

	Size		Size
15-450	240 x 240 mm	15-461	230 x 125 mm
15-451	355 x 400 mm	15-462	200 x 150 mm
15-452	300 x 150 mm	15-463	250 x 200 mm
15-453	300 x 180 mm	15-464	300 x 250 mm
15-454	300 x 240 mm	15-465	350 x 300 mm
15-455	340 x 320 mm	15-466	400 x 350 mm
15-456	230 x 180 mm	15-467	450 x 300 mm
15-457	250 x 130 mm	15-468	300 x 200 mm
15-458	200 x 130 mm	15-469	350 x 250 mm
15-459	180 x 130 mm	15-470	250 x 125 mm
15-460	150 x 100 mm	15-471	200 x 100 mm
		15-472	400 x 200 mm



**INSTRUMENT TRAY WITHOUT COVER**

	Size		Size
15-480	240 x 240 mm	15-491	230 x 125 mm
15-481	355 x 400 mm	15-492	200 x 150 mm
15-482	300 x 150 mm	15-493	250 x 200 mm
15-483	300 x 180 mm	15-494	300 x 250 mm
15-484	300 x 240 mm	15-495	350 x 300 mm
15-485	340 x 320 mm	15-496	400 x 350 mm
15-486	230 x 180 mm	15-497	450 x 300 mm
15-487	250 x 130 mm	15-498	300 x 200 mm
15-488	200 x 130 mm	15-499	350 x 250 mm
15-489	180 x 130 mm	15-500	250 x 125 mm
15-490	150 x 100 mm	15-501	200 x 100 mm
		15-502	400 x 200 mm



# HOLLOW WARES



**KIDNEY TRAY WITH COVER**  
(English Pattern)

	Size
15-510	150 mm
15-511	200 mm
15-512	240 mm
15-513	300 mm



**KIDNEY TRAY (German Pattern)**  
(without cover)

	Size
15-520	150 mm
15-521	200 mm
15-522	240 mm
15-523	300 mm



**SPLIT LAMP**  
15-530  
100 ml.



**BOWL**

	Size
15-540	80 mm
15-541	100 mm
15-542	125 mm
15-543	150 mm
15-544	200 mm
15-545	250 mm
15-546	300 mm
15-547	350 mm
15-548	400 mm



**WASH BASIN**

	Size
15-560	80 mm
15-561	100 mm
15-562	125 mm
15-563	150 mm
15-564	200 mm
15-565	250 mm
15-566	300 mm
15-567	350 mm
15-568	400 mm

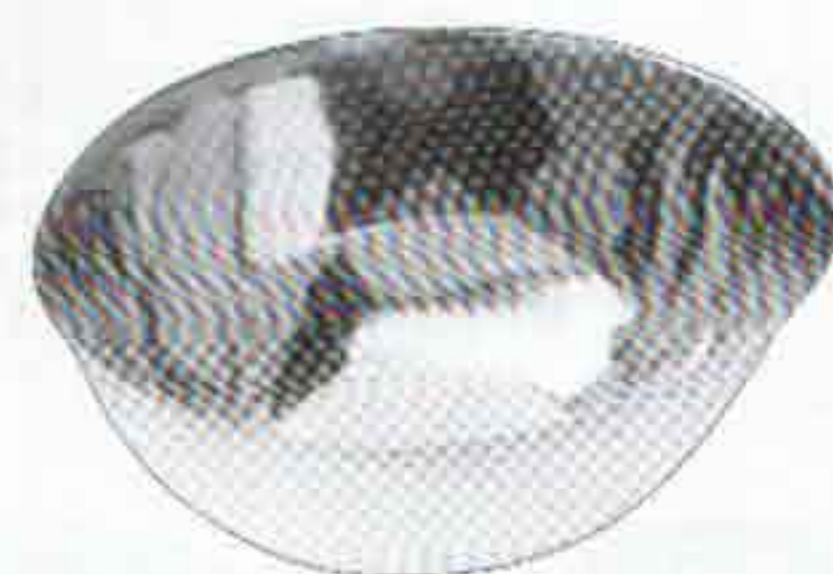

**BOWL**

	Size
15-580	80 mm
15-581	100 mm
15-582	125 mm
15-583	150 mm
15-584	200 mm
15-585	250 mm
15-586	300 mm
15-587	350 mm
15-588	400 mm



**DRESSING JAR WITH KNOB**

	Size
15-600	80 x 80 mm
15-601	100 x 100 mm
15-602	125 x 125 mm
15-603	150 x 150 mm
15-604	200 x 200 mm



**DRESSING JAR**

	Size
15-610	80 x 80 mm
15-611	100 x 100 mm
15-612	125 x 125 mm
15-613	150 x 150 mm
15-614	200 x 200 mm



**DRESSING JAR**

	Size
15-620	80 x 80 mm
15-621	100 x 100 mm
15-622	125 x 125 mm
15-623	150 x 150 mm
15-624	200 x 200 mm



**DRESSING JAR**

	Size
15-630	80 x 80 mm
15-631	100 x 100 mm
15-632	125 x 125 mm
15-633	150 x 150 mm
15-634	200 x 200 mm



# HOLLOW WARES



**FORCEPS JAR**

	Size
15-640	55 x 100 mm
15-641	55 x 140 mm
15-642	55 x 170 mm
15-643	55 x 180 mm
15-644	80 x 100 mm



**FORCEPS JAR**

	Size
15-650	55 x 100 mm
15-651	55 x 140 mm
15-652	55 x 170 mm
15-653	55 x 180 mm
15-654	80 x 100 mm



**FORCEPS JAR**

	Size
15-660	55 x 100 mm
15-661	55 x 140 mm
15-662	55 x 170 mm
15-663	55 x 180 mm
15-664	80 x 100 mm

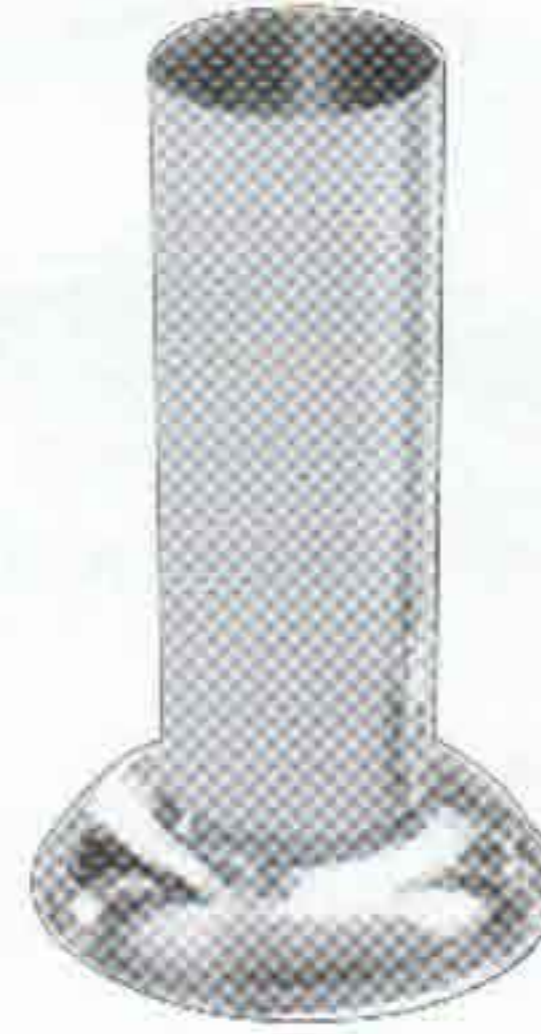

**FORCEPS JAR**

	Size
15-670	55 x 100 mm
15-671	55 x 140 mm
15-672	55 x 170 mm
15-673	55 x 180 mm
15-674	80 x 100 mm



**FORCEPS JAR**

	Size
15-680	55 x 100 mm
15-681	55 x 140 mm
15-682	55 x 170 mm
15-683	55 x 180 mm
15-684	80 x 100 mm



**COTTON HOLDER**  
15-690



**GALIPOTS**

	Capacity
15-700	2 Ounces
15-701	3 Ounces
15-702	4 Ounces
15-703	5 Ounces
15-704	6 Ounces
15-705	7 Ounces
15-706	8 Ounces



**GALIPOTS**

	Capacity
15-710	2 Ounces
15-711	3 Ounces
15-712	4 Ounces
15-713	5 Ounces
15-714	6 Ounces
15-715	7 Ounces
15-716	8 Ounces



**SPRIT LAMP**  
15-720  
100 ml.



**INDO BOX ROUND**  
15-730

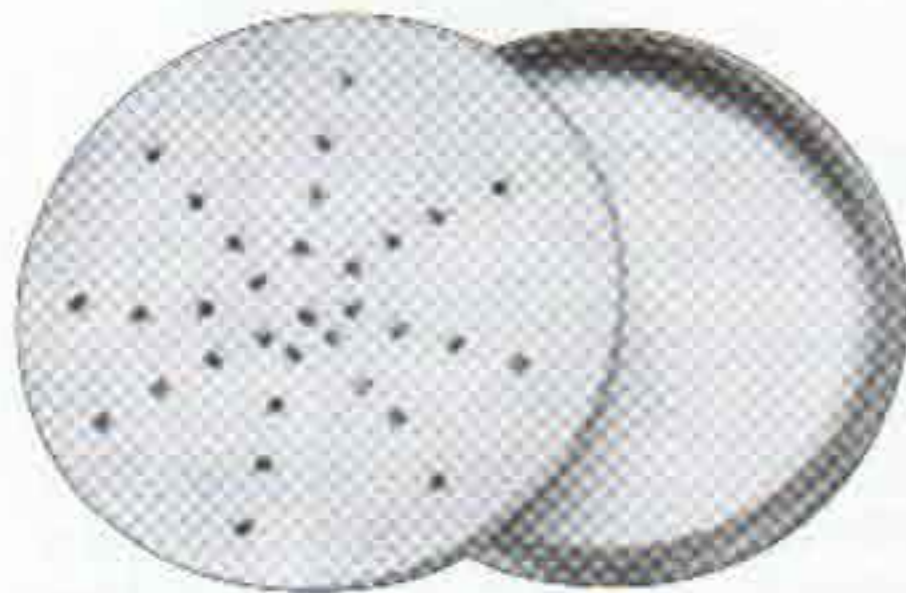

**NEEDLE CASE**  
15-740



**MEASURING JUG**

	Capacity
15-750	1.00 Ltr
15-751	1.50 Ltr
15-752	2.00 Ltr



**MEDICINE CUP GRADUATED**

	Capacity
15-760	50 ml
15-761	60 ml
15-762	100 ml



**BUCKET WITH LID**

	Capacity
15-770	10 Ltr
15-771	12 Ltr
15-772	15 Ltr



# HOLLOW WARES



**SPUTUM MUG**  
15-780  
100 x 50 mm



**ENEMA CANE**  
Capacity  
15-790 0.5 Ltr  
15-791 1.5 Ltr  
15-792 2.0 Ltr



**DUST BIN**  
15-800  
20 Lit



**ROUND BADPAN**  
15-810  
300 x 85 mm



**BEDPAN**  
15-820  
Size: Adult, Child



**BEDPAN**  
15-830  
Size: Adult, Child



**FURNAL**  
15-840  
100 mm



**URINAL - FEMALE**  
15-850

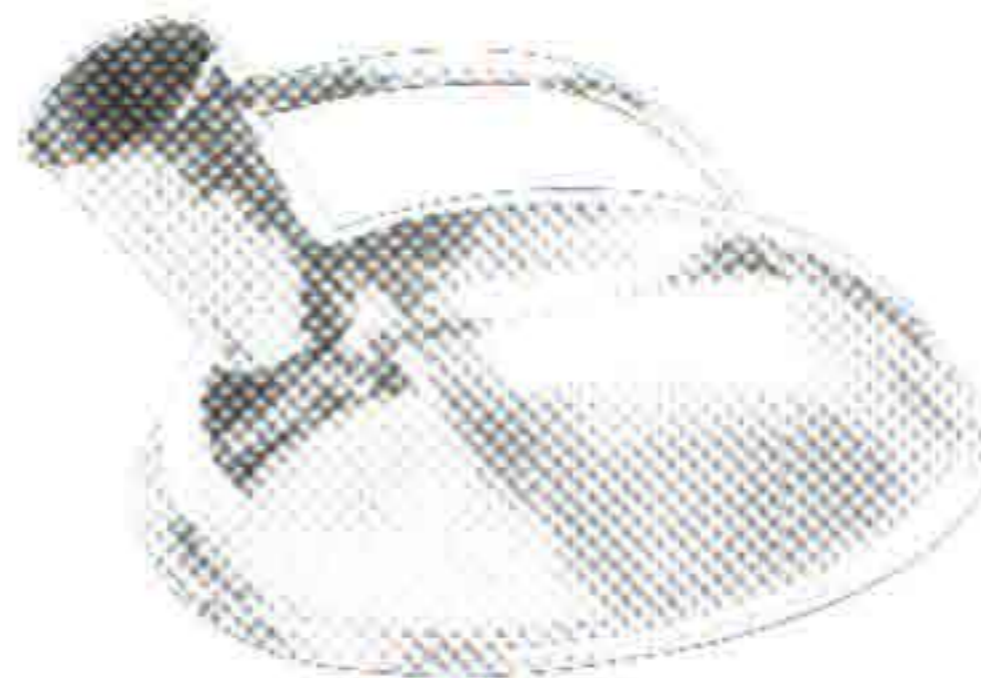

**URINAL - MALE**  
15-860



**SHAVING MUG**  
15-870  
100 mm



## PERFORATED BASKETS

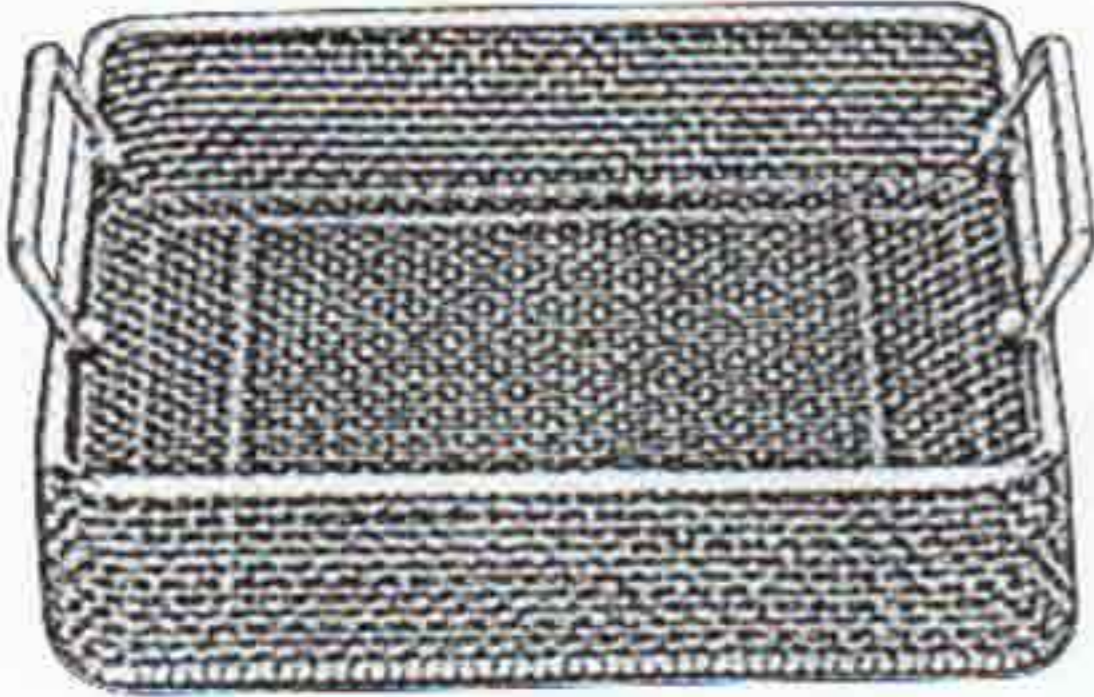

### MESH BASKET

- 15-880 240 x 258 x 50 mm
- 15-881 250 x 240 x 100 mm
- 15-882 240 x 250 x 60mm

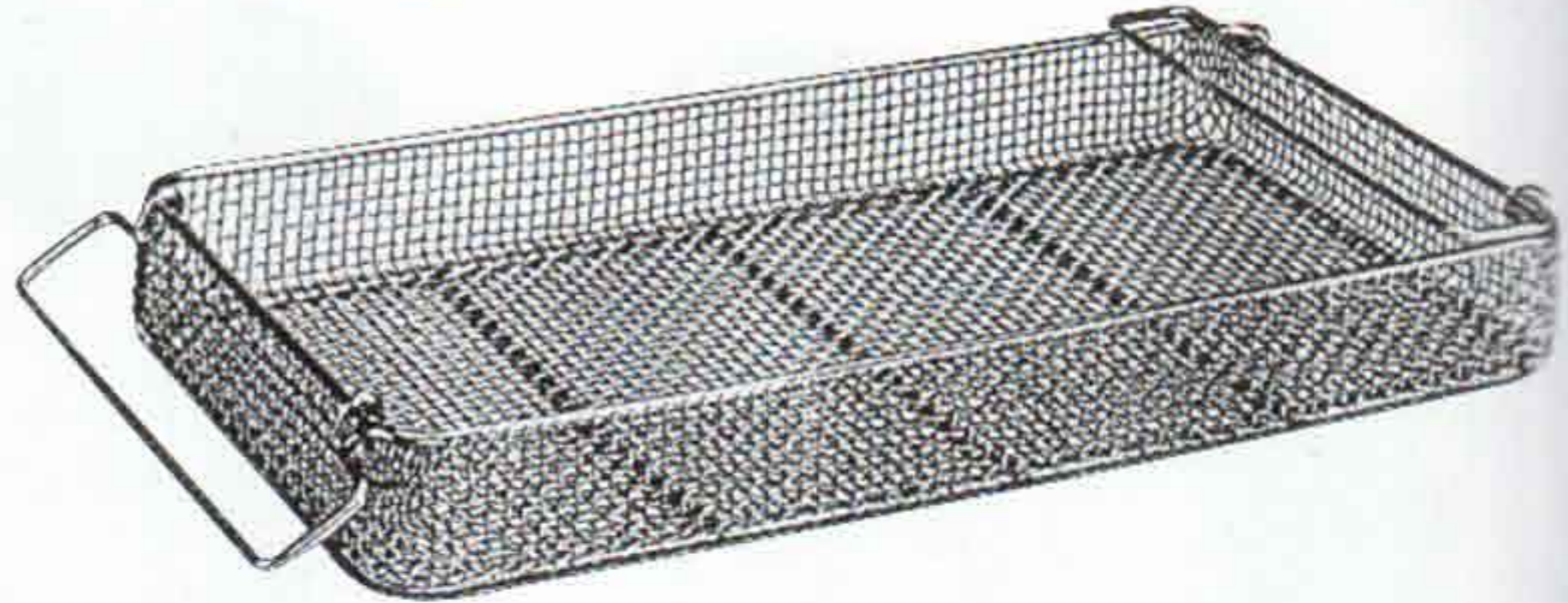

### MESH BASKET

- 15-890 480 x 258 x 50 mm
- 15-891 480 x 258 x 100 mm
- 15-892 520 x 258 x 60mm
- 15-893 520 x 258 x 70mm
- 15-894 450 x 340 x 70mm
- 15-895 320 x 230 x 70mm



### MESH BASKET

With Perforated Sheet Side

- 15-900 230 x 130 x 50 mm
- 15-901 230 x 130 x 60 mm
- 15-902 240 x 130 x 50 mm
- 15-903 240 x 130 x 60 mm
- 15-904 240 x 250 x 50 mm
- 15-905 240 x 250 x 60 mm
- 15-906 480 x 250 x 50 mm
- 15-907 480 x 250 x 60 mm
- 15-908 480 x 250 x 70 mm
- 15-909 300 x 300 x 50 mm
- 15-910 350 x 350 x 60 mm
- 15-911 470 x 400 x 60 mm
- 15-912 480 x 480 x 50 mm
- 15-913 480 x 480 x 60 mm
- 15-914 500 x 300 x 50 mm
- 15-915 520 x 300 x 50 mm
- 15-916 520 x 300 x 60 mm
- 15-917 550 x 430 x 50 mm
- 15-918 600 x 300 x 60 mm



### ARTHROSCOPE BASKET

- 15-930 290 x 80 x 52 mm

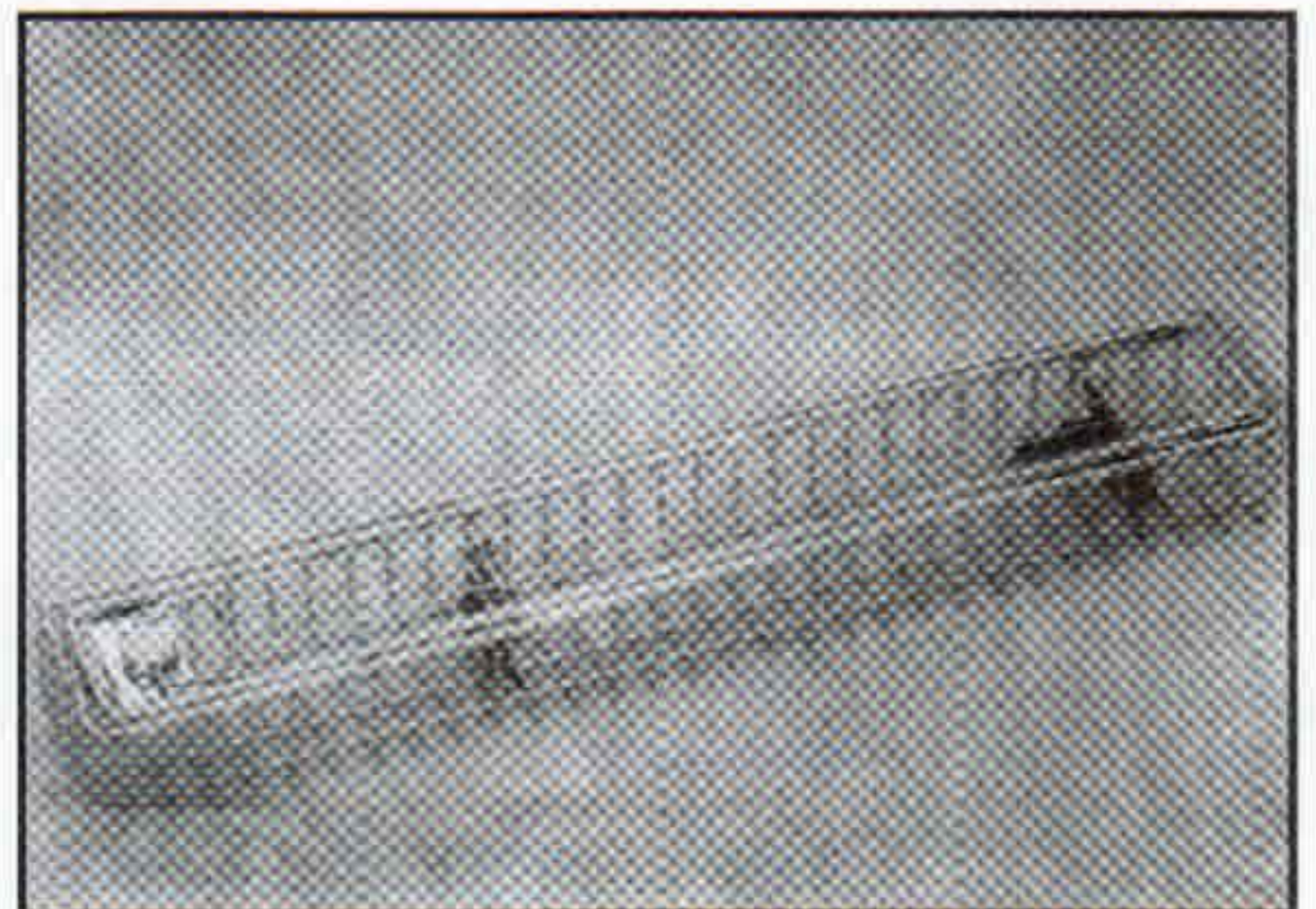

### ENDOSCOPE BASKET

- 15-940 460 x 80 x 52 mm
- 15-941 660 x 80 x 52 mm
- 15-942 670 x 80 x 52 mm